

# TRANS-TEXAS WATER PROGRAM

**West Central  
Study Area**

**Phase II**

**Edwards Aquifer  
Recharge Analyses**

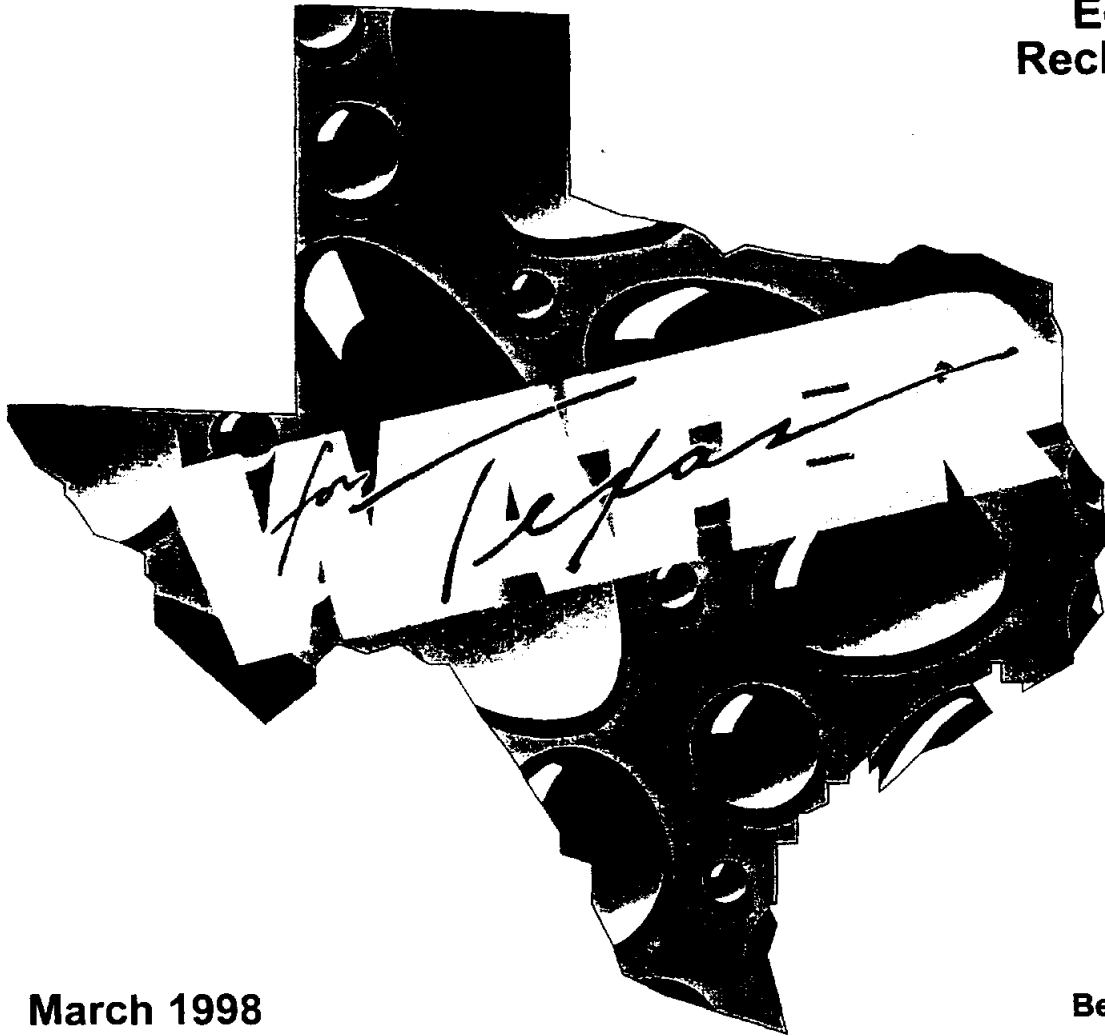

**San Antonio  
River Authority**

**San Antonio  
Water System**

**Edwards Aquifer  
Authority**

**Guadalupe-Blanco  
River Authority**

**Lower Colorado  
River Authority**

**Bexar Metropolitan  
Water District**

**Nueces River  
Authority**

**Canyon Lake Water  
Supply Corporation**

**Bexar-Medina-Atascosa  
Counties WCID No. 1**

**Texas Natural Resource  
Conservation Commission**

**Texas Parks and  
Wildlife Department**

**Texas Water  
Development Board**

**March 1998**

**HDR**

HDR Engineering, Inc.  
Paul Price Associates, Inc.  
LBG-Guyton Associates  
Fugro-McClelland (SW), Inc.

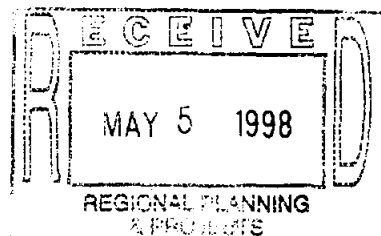

**TRANS-TEXAS WATER PROGRAM  
WEST CENTRAL STUDY AREA**

**PHASE 2**

**EDWARDS AQUIFER RECHARGE ANALYSES**

**TABLE OF CONTENTS**

**Report 1 Guadalupe - San Antonio River Basin  
Recharge Enhancement Study  
Feasibility Assessment**

**Report 2 Conceptual Evaluation of Springflow Recirculation**

**Report 3 Modification of Principal Spillways at Existing  
Flood Control Projects for Recharge Enhancement**

**Report 4 Edwards Aquifer Recharge Update**

**Report 1**

**Guadalupe - San Antonio River Basin  
Recharge Enhancement Study  
Feasibility Assessment**

**TRANS-TEXAS WATER PROGRAM  
WEST CENTRAL STUDY AREA**

**PHASE 2**

**EDWARDS AQUIFER  
RECHARGE UPDATE**

**San Antonio River Authority  
San Antonio Water System  
Edwards Aquifer Authority  
Guadalupe-Blanco River Authority  
Lower Colorado River Authority  
Bexar Metropolitan Water District  
Nueces River Authority  
Canyon Lake Water Supply Corporation  
Bexar-Medina-Atascosa Counties WCID No. 1  
Texas Natural Resource Conservation Commission  
Texas Parks and Wildlife Department  
Texas Water Development Board**



March 1998

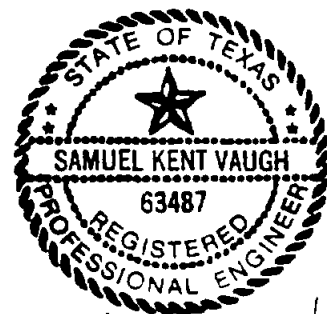

*Samuel K Vaughn*  
3/25/98

**GUADALUPE - SAN ANTONIO RIVER BASIN  
RECHARGE ENHANCEMENT STUDY  
FEASIBILITY ASSESSMENT**

**TABLE OF CONTENTS**

<b>Section</b>	<b>Page</b>
<b>1.0 INTRODUCTION.....</b>	1-1
<b>2.0 RECHARGE ENHANCEMENT PROJECTS .....</b>	2-1
<b>2.1 Cibolo Creek Project (L-21A).....</b>	2-1
2.1.1 Description of Alternative.....	2-1
2.1.2 Recharge Enhancement Hydrology .....	2-3
2.1.3 Environmental Issues .....	2-4
2.1.4 Water Quality and Treatability .....	2-11
2.1.5 Engineering and Costing.....	2-11
2.1.6 Implementation Issues .....	2-18
<b>2.2 Lower Blanco Project with 24” Diversion Pipeline to Upper     San Marcos Watershed (L-21B) .....</b>	2-19
2.2.1 Description of Alternative.....	2-19
2.2.2 Recharge Enhancement Hydrology .....	2-24
2.2.3 Environmental Issues.....	2-25
2.2.4 Water Quality and Treatability .....	2-30
2.2.5 Engineering and Costing.....	2-30
2.2.6 Implementation Issues .....	2-35
<b>2.3 Upper Blanco Project with 24” Diversion Pipeline to Upper     San Marcos Watershed (L-21C) .....</b>	2-39
2.3.1 Description of Alternative.....	2-39
2.3.2 Recharge Enhancement Hydrology .....	2-44
2.3.3 Environmental Issues .....	2-45
2.3.4 Water Quality and Treatability .....	2-48
2.3.5 Engineering and Costing.....	2-48
2.3.6 Implementation Issues .....	2-52
<b>2.4 San Geronimo Creek Project (L-21D) .....</b>	2-55
2.4.1 Description of Alternative.....	2-55
2.4.2 Recharge Enhancement Hydrology .....	2-57
2.4.3 Environmental Issues.....	2-58
2.4.4 Water Quality and Treatability .....	2-62
2.4.5 Engineering and Costing.....	2-62
2.4.6 Implementation Issues .....	2-66

<b>2.5</b>	<b>Northern Bexar / Medina County Project Sites (L-21E)</b> .....	2-71
2.5.1	Description of Alternative.....	2-71
2.5.2	Recharge Enhancement Hydrology .....	2-71
2.5.3	Environmental Issues .....	2-75
2.5.4	Water Quality and Treatability .....	2-80
2.5.5	Engineering and Costing.....	2-80
2.5.6	Implementation Issues .....	2-82
<b>3.0</b>	<b>RECHARGE ENHANCEMENT PROGRAM DEVELOPMENT</b> .....	3-1
<b>3.1</b>	<b>Sizing of Projects in Guadalupe - San Antonio River Basin</b> .....	3-1
<b>3.2</b>	<b>Summary of Recommended Recharge Enhancement Program for</b> <b>Guadalupe - San Antonio River Basins (L-21)</b> .....	3-6
<b>3.3</b>	<b>Combined Projects in Nueces and Guadalupe - San Antonio</b> <b>River Basins (L-18A)</b> .....	3-9

**APPENDICES**

- Appendix A - Recharge Project Evaluation Methodology
- Appendix B - Environmental Report by Paul Price Associates, Inc.
- Appendix C - Hydrogeologic Evaluation by LBG-Guyton Associates

## LIST OF FIGURES

Figure No.		Page
1.0-1	Guadalupe - San Antonio River Basin Map .....	1-2
1.0-2	Location of Potential Recharge Enhancement Projects .....	1-4
2.1-1	Cibolo Creek Project - Site Map .....	2-2
2.1-2	Cibolo Creek Project - Changes in Streamflow .....	2-10
2.1-3	Cibolo Creek Project - Centerline Profile .....	2-14
2.1-4	Cibolo Creek Project - Evaluation Summary .....	2-15
2.1-5	Cibolo Creek Project - Annual Recharge .....	2-16
2.1-6	Cibolo Creek Project - Storage Frequency .....	2-17
2.2-1	Lower Blanco Project - Site Map .....	2-21
2.2-2	Lower Blanco Project - Diversion Pipeline .....	2-23
2.2-3	Lower Blanco Project - Changes in Streamflow .....	2-29
2.2-4	Lower Blanco Project - Centerline Profile .....	2-32
2.2-5	Lower Blanco Project - Evaluation Summary .....	2-34
2.2-6	Lower Blanco Project - Annual Recharge .....	2-36
2.2-7	Lower Blanco Project - Storage Frequency .....	2-37
2.3-1	Upper Blanco Project - Site Map .....	2-41
2.3-2	Upper Blanco Project - Diversion Pipeline .....	2-43
2.3-3	Upper Blanco Project - Centerline Profile .....	2-51
2.3-4	Upper Blanco Project - Evaluation Summary .....	2-53
2.4-1	San Geronimo Creek Project - Site Map .....	2-56
2.4-2	San Geronimo Creek Project - Changes in Streamflow .....	2-61
2.4-3	San Geronimo Creek Project - Centerline Profile .....	2-65
2.4-4	San Geronimo Creek Project - Evaluation Summary .....	2-67
2.4-5	San Geronimo Creek Project - Annual Recharge .....	2-68
2.4-6	San Geronimo Creek Project - Storage Frequency .....	2-69
2.5-1	Northern Bexar/Medina County Sites - Location Map .....	2-73
3.1-1	Recharge Enhancement Program Development - Cost Summary .....	3-4
3.1-2	Recharge Enhancement Program Development - Storage Summary .....	3-5
3.2-1	Edwards Aquifer Recharge - Guadalupe-San Antonio River Basin .....	3-8
3.2-2	Recharge Enhancement Program - Changes in Streamflow at Saltwater Barrier .....	3-10
3.3-1	Recharge Enhancement Program for Combined Basins - Cost Summary .....	3-14
3.3-2	Recharge Enhancement Program for Combined Basins - Storage Summary .....	3-15

## LIST OF TABLES

<b>Table No.</b>		<b>Page</b>
2.1-1	Cibolo Creek Project Cost and Data Summary.....	2-12
2.2-1	Lower Blanco Project (with 24" Diversion) Cost and Data Summary.....	2-31
2.3-1	Upper Blanco Project (with 24" Diversion) Cost and Data Summary .....	2-50
2.4-1	San Geronimo Creek Project Cost and Data Summary .....	2-64
2.5-1	Northern Bexar/Medina County Projects Cost and Data Summary .....	2-81
3.1-1	Guadalupe - San Antonio River Basin Recharge Enhancement Program Development.....	3-3
3.2-1	Summary of Recommended Recharge Enhancement Program for Guadalupe - San Antonio River Basin.....	3-7
3.3-1	Summary of Recharge Enhancement Program for Nueces River Basin.....	3-12
3.3-2	Combined Recharge Enhancement Program for Edwards Aquifer .....	3-13



## 1.0 INTRODUCTION

The Guadalupe - San Antonio River Basin encompasses over 10,100 square miles extending from the headwaters on the Edwards Plateau north and west of San Antonio through the Texas Blackland Prairie and Claypan Area, the Northern Rio Grande Plain, and the Gulf Coast Prairies to the Guadalupe Estuary south of Victoria (see Figure 1.0-1). The Guadalupe - San Antonio River Basin is crossed by at least five aquifer outcrops or recharge zones, including the Edwards, Carrizo-Wilcox, Queen City, Sparta, and Gulf Coast (Goliad). The most transmissive of these recharge zones is associated with the Edwards limestone aquifer, which is generally located along the Balcones Escarpment. The Edwards Aquifer is the principal source of water supply for the City of San Antonio, as well as numerous other communities and agricultural interests throughout Uvalde, Medina, Bexar, Comal, and Hays Counties. The aquifer also supplies Leona, San Pedro, San Antonio, Comal, and San Marcos Springs, creating unique environments and recreational opportunities while providing base flow to the Leona, San Antonio, Guadalupe, and San Marcos Rivers. Over the past several decades, the increasing water demands on the Edwards Aquifer have raised concerns about the ability of the aquifer to meet these demands without causing social, economic, and environmental problems.

An initial phase of the Guadalupe - San Antonio River Basin Recharge Enhancement Study (completed by the Edwards Underground Water District in 1993) concluded that significant potential exists for the enhancement of Edwards Aquifer recharge through the implementation of programs of identified projects in the Guadalupe - San Antonio River Basin. During the Phase I study, a river basin computer model was developed and applied in the calculation of maximum quantities of recharge enhancement or water potentially available which could reasonably be obtained without regard to costs or environmental concerns. In early 1994, the Edwards Underground Water District (EUWD) contracted with HDR Engineering, Inc. (HDR) to perform a Feasibility Assessment, with the principal objective of optimizing the size of each previously identified project on the basis of cost per unit of recharge enhancement, while considering any potentially significant environmental impacts associated with development.

Additional objectives included the development of site specific recharge curves, daily recharge enhancement calculation, and comprehensive flood hydrology for several projects.

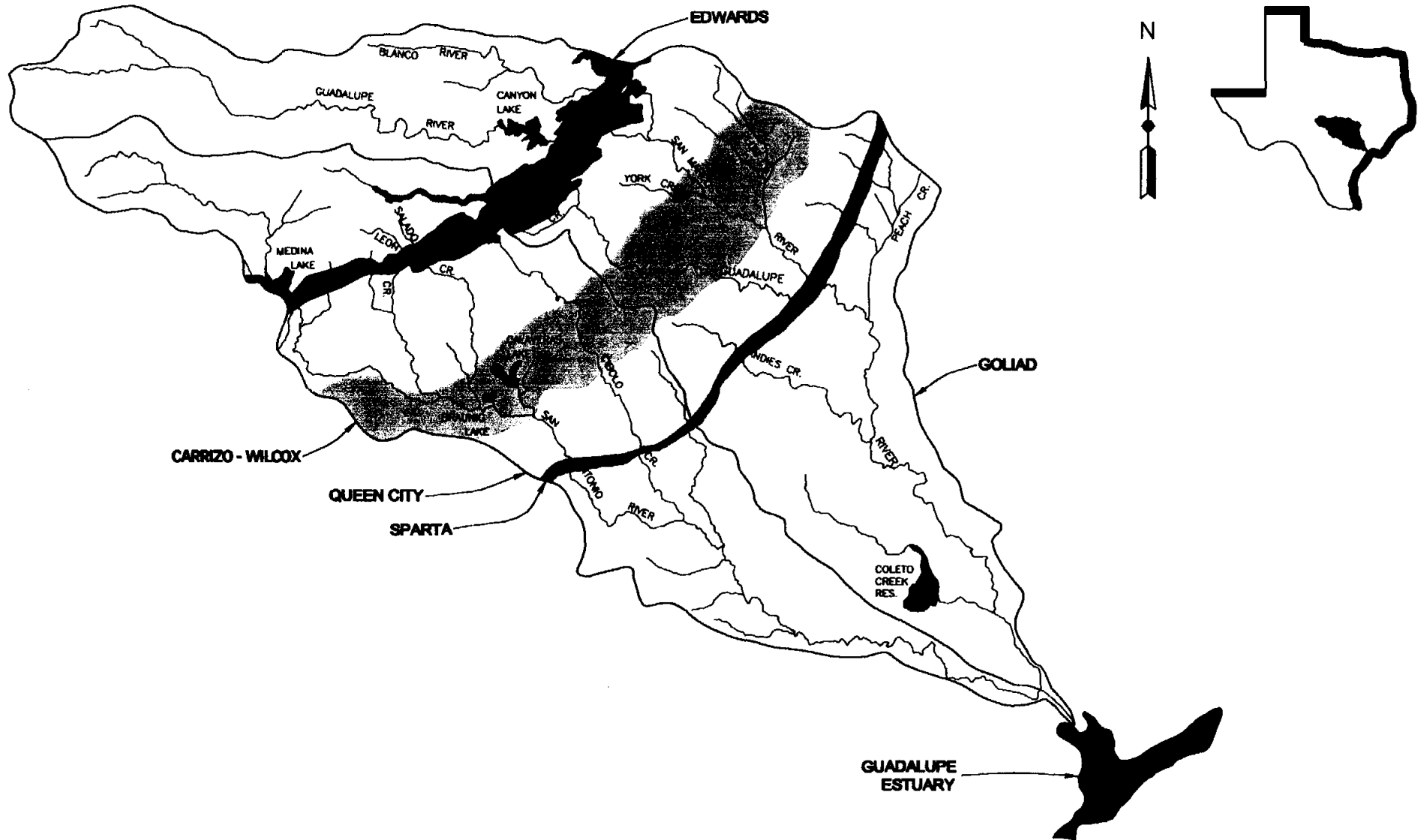

Guadalupe - San Antonio River Basin  
 Recharge Enhancement Study  
 Feasibility Assessment



HDR Engineering, Inc.

TRANS TEXAS WATER PROGRAM/  
 WEST CENTRAL STUDY AREA

**GUADALUPE - SAN ANTONIO  
 RIVER BASIN MAP**

FIGURE 1.0-1

Ultimately, the identified projects were to be ranked and grouped into alternative programs based on acceptable incremental cost criteria. The Edwards Aquifer Authority (EAA) suspended work on the Feasibility Assessment in July, 1996, at which time the work was about two-thirds complete.

Completion of this recharge enhancement study is included as an alternative (L-21) in the West Central Study Area, Phase 2, Trans-Texas Water Program. The tasks necessary to complete the Feasibility Assessment have been performed in a manner consistent with both the original objectives and with other water supply alternatives evaluated in the Trans-Texas Water Program for the West Central Study Area. The Feasibility Assessment has focused on potential structural projects of the types described in Phase I of the Guadalupe - San Antonio River Basin Recharge Enhancement Study. These projects, which are shown on Figure 1.0-2, include:

1. Upper Blanco River (Type 1 structure above Halifax Creek confluence);
2. Lower Blanco River (Type 2 structure west of Kyle);
3. Cibolo Creek (Type 2 structure west of Bracken);
4. San Geronimo Creek (Type 2 structure upstream of existing EAA recharge dam); and
5. Northern Bexar & Medina County (program of five smaller Type 2 projects in the Leon/Helotes/Government Canyon watersheds).

The current scope of work excludes any further analyses of a potential project in the Dry Comal Creek watershed, identified in the original Feasibility Assessment contract with the EUWD, because of very limited recharge enhancement potential (due to small contributing watershed above the project) and past difficulties in obtaining access.

The objective of Alternative L-21 is to develop an appropriate program of recharge enhancement projects in the Guadalupe - San Antonio River Basin by: 1) more accurately computing recharge enhancement to the Edwards Aquifer through site specific evaluations of recharge potential and revisions to the Guadalupe - San Antonio River Basin (GSA Basin) model to employ a daily, rather than a monthly, time step; 2) minimizing costs of project development through comprehensive flood hydrology modeling at the four major projects; and 3) optimizing selected individual recharge projects. Appendix A of this report provides details on the various methodologies applied to calculate recharge enhancement, develop project design floods, and determine various project costs. The unique characteristics of the major recharge enhancement

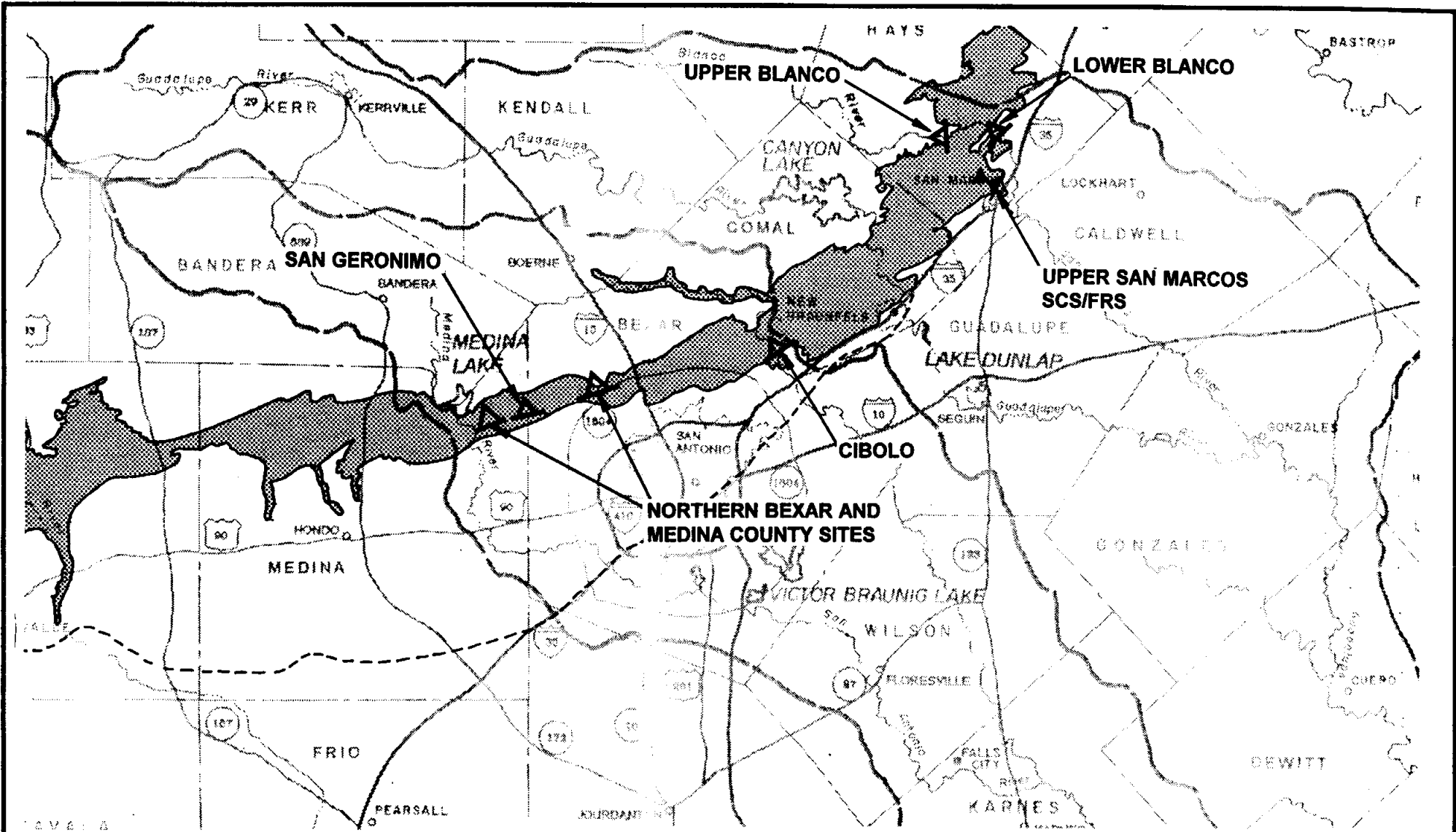

**▲ PROPOSED RECHARGE PROJECT(S)**

**⌘ EXISTING SCS/FRS RESERVOIRS**

**TRANS TEXAS WATER PROGRAM /  
WEST CENTRAL STUDY AREA**

**LOCATION OF POTENTIAL  
RECHARGE ENHANCEMENT  
PROJECTS**



HDR Engineering, Inc.

**FIGURE 1.0-2**

GUADALUPE - SAN ANTONIO RIVER BASIN  
RECHARGE ENHANCEMENT STUDY  
FEASIBILITY ASSESSMENT

projects and the process involved in determining the site optimum size is presented in Section 2. The development of a recommended recharge enhancement program comprised of the individual projects in the Guadalupe - San Antonio River Basin is described in Section 3. Additionally, a composite recharge enhancement program is presented for the Edwards Aquifer considering the results of this study and the recharge enhancement study for the Nueces River Basin completed by the EUWD in June, 1994. An environmental overview of the project area, which encompasses Hays, Comal, Bexar, and Medina Counties, is provided in Appendix B. Site specific environmental issues to be considered in project development are included in the individual project discussions in Section 2 of the report. An assessment of the hydrogeologic setting with respect to direct recharge for the four major project sites is presented in Appendix C.

(This page intentionally left blank)

## 2.0 RECHARGE ENHANCEMENT PROJECTS

### 2.1 Cibolo Creek Project (L-21A)

#### 2.1.1 Description of Alternative

The proposed Cibolo Creek project is located on Cibolo Creek approximately 5.5 miles upstream of the USGS streamflow gauging station at Selma (08185000). The drainage area upstream of Selma is approximately 274 square miles. This project is a Type 2 (direct recharge) project at approximately the same location as one of a series of smaller dams studied by Espey, Huston, and Associates in 1982.<sup>1</sup> The location is shown in Figure 2.1-1. Cibolo Creek in the reach between Boerne and Selma is naturally an efficient recharge reach; however, during large rainfall events flows are periodically sufficient to traverse the recharge zone. The purpose of the proposed structure is to take advantage of the natural ability of Cibolo Creek to recharge large volumes of storm runoff by impounding water that would otherwise flow downstream and allowing it to percolate into the aquifer.

The Cibolo Creek dam site is located within the Edwards Aquifer recharge zone on Cibolo Creek approximately three miles north of Bracken. The proposed dam centerline crosses the creek in an east-west direction and connects Comal County to the east with Bexar County to the west (see Figure 2.1-1). The elevation of the creek bed at the proposed dam centerline is 804 ft-msl. The drainage area above the dam site is 261 square miles.

The dam and proposed recharge pool would be located atop the Kainer Formation of the Edwards Aquifer.<sup>2</sup> The various geologic units of the Kainer Formation exhibit extensive fracturing, jointing, bedding planes and solution features, all of which contribute to the effective recharge of flow in Cibolo Creek to the Edwards Aquifer downstream of Bat Cave Fault. Significant environmental and socioeconomic concern regarding this potential site include the possible effects of the recharge enhancement project on Bracken Bat Cave, the world's largest bat roost, and Natural Bridge Caverns located within two miles of the site. Natural Bridge Caverns receives in excess of 300,000 visitors annually. Concerns regarding the effects of a

---

<sup>1</sup> Espey, Huston & Associates, Inc. (EH&A), "Feasibility Study of Recharge Facilities on Cibolo Creek," Draft Report for Edwards Underground Water District, October, 1982.

<sup>2</sup> Fugro-McClelland (Southwest), Inc., "Geotechnical Consultation - Recharge Enhancement Study, Phase II Guadalupe - San Antonio River Basin," December 23, 1997.

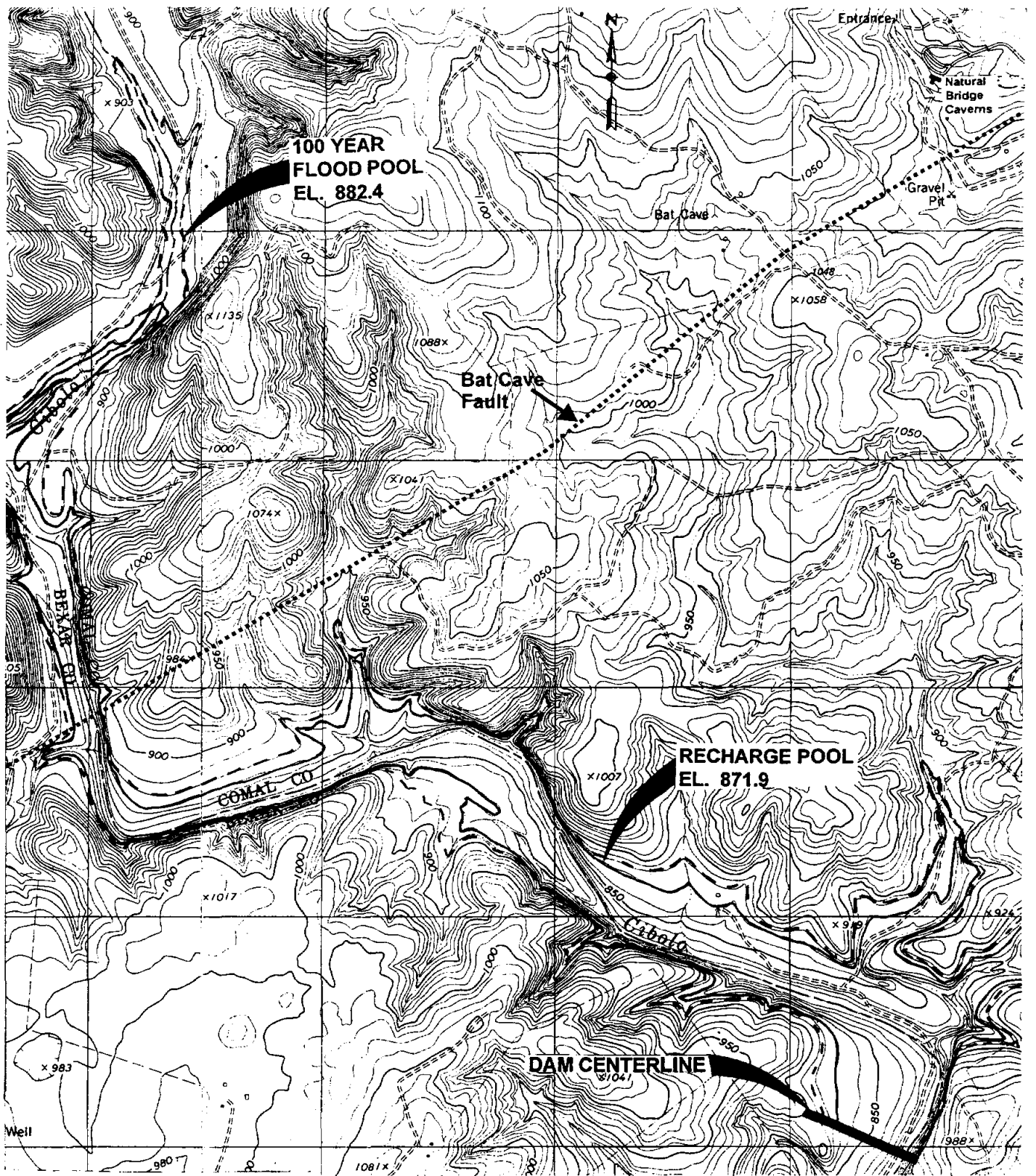

APPROXIMATE SCALE IN FEET



TRANS TEXAS WATER PROGRAM /  
WEST CENTRAL STUDY AREA

GUADALUPE - SAN ANTONIO RIVER BASIN  
RECHARGE ENHANCEMENT STUDY  
FEASIBILITY ASSESSMENT



CIBOLO CREEK PROJECT  
SITE MAP

HDR Engineering, Inc.

FIGURE 2.1-1



proposed recharge project have been raised previously. A study<sup>3</sup> performed for the Edwards Underground Water District cautioned that “it should be very apparent that since the caverns experience water level changes at present, it would be very difficult, without an extensive study and monitoring system, to prove that a recharge structure did not affect those levels.”<sup>4</sup> In recent correspondence, the National Park Service proposes to recommend that Natural Bridge Caverns be listed as a threatened site in the “Damaged and Threatened National Natural Landmarks” report which they prepare annually for Congress.<sup>5</sup>

### 2.1.2 Recharge Enhancement Hydrology

The Cibolo Creek project recharge pool capacities analyzed in this study were operated on a daily timestep, honoring all downstream existing water rights, and assuming original Trans-Texas environmental flow requirements for new reservoirs. A unique recharge rate curve was developed for this site (see Figure A.2-4, in Appendix A) and recharge at the site included natural recharge upstream and downstream of the project and direct percolation in the recharge pool. Details of the recharge reservoir operations, development of the recharge rate curves, and environmental flow requirements used are discussed in Appendix A.

Recharge pool capacities ranging from 1,000 to 50,000 acre-feet (acft) were evaluated for the Cibolo Creek project, and long-term average recharge enhancement (1934-89) ranged from 3,787 acft per year (acft/yr) for the 1,000 acft project to 12,849 acft/yr for the largest recharge pool capacity (50,000 acft). Drought average recharge enhancement (1947-56) was found to be considerably less, ranging from 382 acft per year to 2,469 acft/yr for the smallest and largest sizes, respectively. The 10,000 acft capacity Cibolo Creek project was included in the recommended program of recharge enhancement projects (see Section 3.0) and the long-term and drought average annual recharge enhancements for this size project were found to be 9,733 acft/yr and 1,485 acft/yr, respectively. The reservoir sizes were also analyzed assuming no environmental flow passage criteria and the resulting recharge enhancements at the

---

<sup>3</sup> EH&A, “Feasibility Study of Recharge Facilities on Cibolo Creek,” Draft Report for Edwards Underground Water District, October, 1982.

<sup>4</sup> EH&A, Op. Cit. 1982.

<sup>5</sup> Letter to Reginald Wuest, Vice President, Natural Bridge Caverns from Joe Sovick, U.S. Dept. of Interior, National Park Service, SW Region, Santa Fe, NM, dated August 1, 1995.

recommended size (10,000 acft) showed no increase under drought conditions (1947-56) and only 21 acft/yr additional long-term average enhancement.

### 2.1.3 Environmental Issues

The Cibolo Creek recharge project is a proposed Type 2 (direct recharge) impoundment on Cibolo Creek, which defines the county line between Bexar County to the southwest and Comal County to the northeast. The site is located about three miles north of Bracken, a suburb of San Antonio, where the land is predominantly oak-Ashe juniper wood and is used primarily for cattle ranching. This site has been previously described as a recharge site<sup>6</sup> and the biogeography and geology of the area have been described previously in the context of the Trans-Texas Water Program, West Central Study Area (Section 3.9, Volume 2; Section 3.48, Volume 4).<sup>7</sup>

Bexar County is largely urban and serves as a wholesale, retail, and distribution center for a wide area.<sup>8</sup> San Antonio is the tenth largest city in the nation and third largest city in Texas. Tourism and federal military expenditures represent a significant contribution to the economy of the area. The population density of Comal County is about 10 percent that of Bexar County. Hot, humid summers and variable winters characterize the climate of this subtropical region. The number of days with temperatures over 90° F averages over 110 per year and the growing season averages over 260 days. Thunderstorms, peaking in late spring and early fall, account for much of the rainfall which ranges from 29 to 34 inches in the two county area. For a more detailed description regarding land use and economy, see Appendix B, Section 2.6.

Land uses, habitat types, and wetland occurrences within the study area were identified and evaluated using available literature and a variety of other sources, including the Texas Natural Resources Information System's aerial photography and map database; Texas Highway Department aerial photography; Texas Parks and Wildlife Department (TPWD), Resource Protection Division's data and mapping files for endangered, protected and sensitive resources; Texas Organization for Endangered Species (TOES) listings of endangered, protected and

---

<sup>6</sup> EH&A, "Feasibility Study of Recharge Facilities on Cibolo Creek," Draft Report for Edwards Underground Water District, October, 1982.

<sup>7</sup> HDR. 1995. Trans-Texas Water Program, West Central Study Area-Phase 1 Interim Report. Volume 4. HDR Engineering, Inc. Austin, Texas. November 1995.

<sup>8</sup> Clements, J. 1988. Texas Facts: A Comprehensive Look at Texas Today County by County. Clements Research II, Inc. Dallas, Texas.

sensitive resources; U.S. Fish and Wildlife Service (USFWS) National Wetland Inventory (NWI) maps; information available from the Edwards Aquifer Research and Data Center; USGS library resources; Texas Natural Resource Conservation Commission (TNRCC) publications and library; consultant reports; and the general biological literature, particularly descriptions of the habitat requirements of species listed as Endangered or Threatened by either the U.S. Department of the Interior or the State of Texas. This database, including archeological sites, significant environmental features, state natural areas, protected species and potential wetland areas is maintained at Paul Price Associates, Inc. on USGS 7.5 minutes quadrangles.

The northern half of Bexar County and all of Comal County are within the Edwards Plateau and Blackland Prairies vegetational areas (Appendix B, Section 2.2). The southern half of Bexar County is within the South Texas Plains.<sup>9</sup> The proposed Cibolo Creek recharge project is located within the Edwards Plateau vegetational area, near its southeastern margin, which contacts the Blackland Prairie. Habitat types reported to occur at the proposed recharge site include live oak (*Quercus virginiana*) - Ashe juniper (*Juniperus ashei*) wood, live oak - Ashe juniper park, and live oak - mesquite (*Prosopis glandulosa*) - Ashe juniper park.<sup>10</sup>

The proposed Cibolo Creek site is located in the Balcones Fault Zone, on the Balcones Escarpment, upstream of the Blackland Prairie.<sup>11,12</sup> The Balcones Escarpment is the southern and eastern end of the uplifted Edwards Plateau. It is characterized by a complex of porous, faulted limestones in streambeds, sinkholes, and fractures which allow substantial volumes of water to flow into the Edwards Aquifer (see Appendix B, Section 2.2 Habitats and Biogeography). The Balcones Fault is a transitional zone between the Edwards Plateau and the Blackland Prairie and forms unique habitats favorable to a number of rare and protected species. The common isolated springs and caves favor endemism, where organisms become narrowly adapted to the stable, local environment.

---

<sup>9</sup> Gould, F.W. 1962. Texas Plants - A Checklist and Ecological Summary. Texas Agricultural Experiment Station. MP-585.

<sup>10</sup> McMahan, C.A., R.G. Frye and K.L. Brown. 1984. The Vegetation Types of Texas Including Crop. Wildlife Division, Texas Parks and Wildlife Department, Austin, Texas.

<sup>11</sup> Omernik, J.M. 1987. Ecoregions of the conterminous United States. Annals of the Association of American Geographers 77:11-125.

<sup>12</sup> Gould, F.W. 1962. The grasses of Texas. Texas A&M University Press. College Station, Texas.

The surface geology of the Cibolo Creek site is Cretaceous Edwards and Glen Rose limestone.<sup>13</sup> The soil units that have been deposited in the streambed and floodplain are from the Tarrant Association (gently undulating), Tarrant Association (rolling), Tarrant Association (hilly), Ekrant-Rock Outcrop Complex (steep), Comfort-Rock Outcrop Complex (undulating), Patrick soils (3 to 5 percent slopes), Crawford and Bexar stony soils, and Trinity and Frio soils (frequently flooded).<sup>14,15</sup>

The rough, irregular surface of the plateau is well drained, being dissected by several perennially flowing river systems that have their origin in the large number of springs in this limestone-based region. Because of the many large canyons and rugged terrain, this area is botanically of much interest and has been visited by many botanical collectors. The brush species on the uplands are generally considered to be invaders, however, the steeper canyon slopes have continually supported a dense oak-juniper thicket. Climax vegetation on the plateau is primarily grassland and open savannah. The most important climax grasses of the plateau include switchgrass (*Panicum virgatum*), several species of bluestems and gramas, Indian grass (*Sorghastrum nutans*), Canada wild-rye (*Elymus canadensis*), curly mesquite (*Hilaria belangeri*), and buffalo grass (*Buchloe dactyloides*).

The project area can be characterized as live oak wood and park, or live oak - Ashe juniper wood and park depending on location. The bed of Cibolo Creek in the project area is between approximately 50 to 100 feet wide, dry, and consists of large boulders and gravels. Scattered clumps of brush are found throughout the bed of the creek. The channel is lined with very large live oak trees and a very sparse understory consisting mainly of small Ashe junipers, persimmons (*Diospyros texana*), and frostweed (*Verbesina virginica*). The vegetation, past the large oaks away from the creek bottom, was predominantly oak woodland with a very heavy understory of small Ashe juniper trees. Numerous juniper stumps were also seen throughout this area apparently from years of clearing junipers from the landscape. At the bend in Cibolo Creek just upstream from the proposed damsite, a small tributary channel comes in from the north. The

---

<sup>13</sup> Fisher, W.L. 1983. Geologic Atlas of Texas: San Antonio Sheet. Bureau of Economic Geology. The University of Texas at Austin. Austin, Texas.

<sup>14</sup> Batte, C.D. 1984. Soil Survey of Comal and Hays Counties, Texas. United States Department of Agriculture Natural Resource Conservation Service.

<sup>15</sup> Taylor, F.B., R.B. Hailey, and D.L. Richmond. 1991. Soil Survey of Bexar County, Texas. United States Department of Agriculture Natural Resources Conservation Service.

slope forest leading down to the small tributary channel bottom consists, almost exclusively, of mature Ashe juniper trees. Once in the channel bottom, however, very large live oaks, cedar elms, and junipers provided canopy cover. Small clearings were found scattered throughout the wooded areas that were dominated by prairie coneflowers, small euforbes, and grasses.

Based on the location of the proposed project site, the endangered, threatened, or important species that could occur include Golden-cheeked warbler (*Dendroica chrysoparia*), Black-capped vireo (*Vireo atricapillus*), Texas horned lizard (*Phrynosoma cornutum*), Edwards Plateau Spring Salamander (*Eurycea* sp. 7), and in subterranean karst and springs, the Cascade Cavern salamander (*E. latitans*) and the Comal Blind Salamander (*E. tridentifera*) (Appendix B, Tables 1 and 2). See Appendix B, Section 2.5 for discussions of the potential protected species of the area. Although the TPWD data files show no confirmed reports of any endangered, threatened, or important species within the site of the proposed recharge project, very little information is known about this site and an intensive survey of the project area would be required to accurately describe the habitats within the project area and determine the potential occurrence of any of these species.

Karst surveys of the proposed project area<sup>16</sup> and previous reports have identified numerous caves and karst features found in within and near the proposed recharge site which could be affected by its implementation.<sup>17</sup> The two most notable nearby features are Bracken Bat Cave and Natural Bridge Caverns, which could be affected by the construction and operation of the proposed recharge project.<sup>18</sup> Although none of the important cave invertebrates in Bexar County are listed (Appendix B, Tables 1 and 2) as being reported to occur on the project site, some of the cave invertebrates are known to inhabit caves in the project area. For example, Poison Ivy Pit has been reported to contain an isopod (an unidentified species of the family Trichoniscidae), spiders (*Eidmannella rostrata*, *Modisimus texanus*), harvestmen (*Leiobumum townsendii*), cave crickets (*Ceuthophilus secretus*), and cave beetles including *Rhadina infernalis*. The mouth of Poison Ivy Pit is located at elevation 995 ft-msl, and the bottom is located at 899 ft-msl which is above the proposed recharge pool level of 872 ft-msl.

---

<sup>16</sup> Dr. William Elliott. 1995. Personal Communication.

<sup>17</sup> EH&A, "Feasibility Study of Recharge Facilities on Cibolo Creek," Draft Report for Edwards Underground Water District, October, 1982.

<sup>18</sup> Ibid.

Several springs exist within the project area and may be flooded by the proposed recharge pool level of 872 ft-msl. These include Cherry Spring, Walnut Spring, and Devine Spring. Indian Spring appears to be at or above elevation 1000 ft-msl and would not be affected by the proposed recharge pool. Large numbers of Ranid and cricket frogs inhabit Walnut Spring; fewer numbers of the same species were observed at Devine Spring. Devine Spring is reported to support a population of the Texas salamander (*Eurycea neotenes*). An on-site survey of Devine Springs and Walnut Springs revealed no Texas salamanders, although it was suspected that the water may have been too warm and stagnant and that the salamanders may have retreated down into the springs for refuge.<sup>19</sup> The Texas salamander is endemic to the Balcones Escarpment and adjacent portions of the Edwards Plateau of south central Texas. Although the Texas Salamander is not listed as endangered or threatened by USFWS, TPWD, or TOES, there is concern for this species due to its habitat.

The proposed project would periodically inundate predominantly rocky creek beds on Cibolo, West Fork, and Clear Creeks. The beds of these creeks are classified on National Inventory Wetland maps as riverine, intermittent, and temporarily or seasonally flooded. Based on field observation, aerial photographs, and NWI maps, it was estimated that the project would inundate about 44.5 acres of dry streambed. It is not expected that an instream flow release will be necessary for this proposed project due to the intermittent flow regime in this section of Cibolo Creek. Springs and small spring-fed tributaries support the perennial upstream section. This section extends for about 20 miles from the headwaters to the western edge of the Edwards Aquifer recharge zone. At this point, the stream rapidly drains into the substrate where it supplies water to the aquifer. The middle section, which contains the proposed recharge project site, extends for about 50 miles to the Balcones fault zone and during base flow conditions is completely dry. The downstream section begins near Schertz, in Bexar and Guadalupe Counties, and has perennial flows supported by spring seepage and effluent from the Schertz wastewater treatment facility.

Modeling flows at Selma indicated a decrease in annual average flows from 13,018 acft/yr without the Cibolo Creek recharge enhancement project to 3,261 acft/yr with implementation, a

---

<sup>19</sup> Elliott, W. 1994. Field notes from a visit to the site. Paul Price Associates, Inc. Austin, Texas. September 12, 1995.

74 percent decrease. A plot of the changes in annual flow deciles with and without the project at its recommended size (10,000 acft) is shown in Figure 2.1-2. The decrease in flows in the highest decile (91-100%), due to the project, is approximately 57 percent. Monthly median flows for Cibolo Creek at Selma with and without implementation of the project would be zero based on the historical modeling period of 1934 to 1989. Zero monthly medians indicate that flows through this area of Cibolo Creek come in short intense spate periods. Below the project area Cibolo Creek is perennially sustained by springs and municipal treated effluent to its confluence with the San Antonio River.

A search of the database at the Texas Archeological Research Laboratory (TARL) revealed only one archeological site recorded from within the general area of the proposed recharge project. Prior to inundation, it must be determined if any cultural properties are located within the project area by an on-site survey. Once all cultural properties within the project area are identified, they will undergo preliminary assessment, during the survey, to determine the significance and potential for eligibility in the Register of Historic Places. Because the assessment methods used during the survey are limited in their ability to determine significance potential, some sites may need to be subjected to more extensive test-level investigations before their eligibility can be adequately determined. Once cultural resource properties are determined to be eligible, they must either enter mitigation through avoidance or undergo scientific data recovery (see Appendix B, Section 2.7).

In summary, the environmental concerns associated with this proposed recharge project include evaluation of the oak-Ashe juniper woods and parks within the project area for utilization by protected species, evaluation of the impact of inundation on important habitats such as Bracken Bat Cave and Natural Bridge Caverns, and the evaluation of the historic significance of cultural resources sites, (Appendix B, Table 6). Estimated environmental related costs for the Cibolo Creek recharge project can be found in Appendix B, Table 7. These estimates are based on a recharge pool level of 872 ft-msl. Environmental report costs include baseline surveys, a comprehensive Environmental Assessment, and permit support.

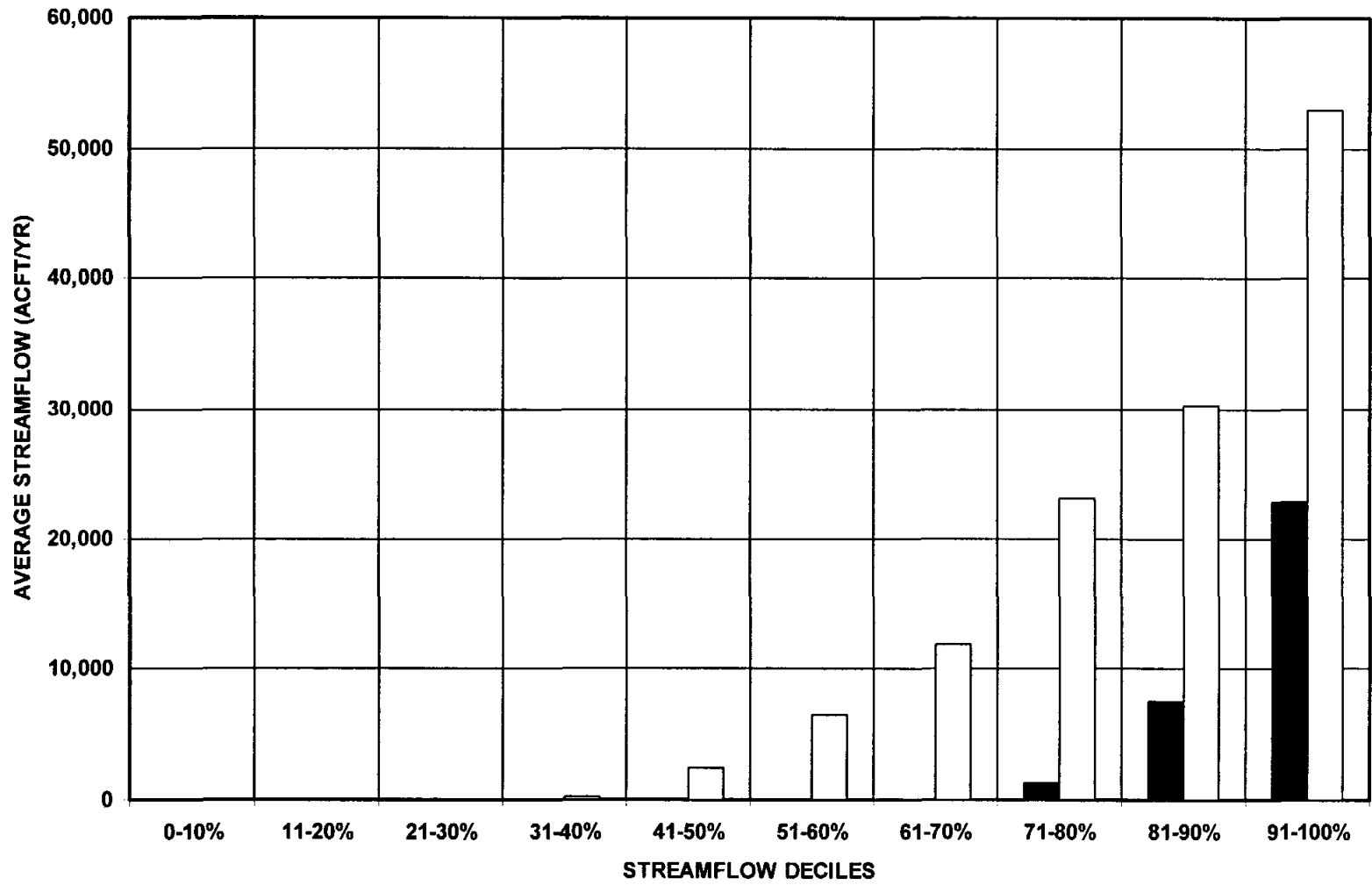

■ WITH PROJECT

□ WITHOUT PROJECT

NOTE: STATISTICS BASED ON 1934-89 HISTORICAL PERIOD.  
MONTHLY MEDIAN STREAMFLOWS WITH AND WITHOUT PROJECT ARE ZERO.

TRANS TEXAS WATER PROGRAM / WEST CENTRAL STUDY AREA  
**CIBOLO CREEK PROJECT**  
CHANGES IN STREAMFLOW  
CIBOLO CREEK AT SELMA



HDR Engineering, Inc.

GUADALUPE - SAN ANTONIO RIVER BASIN  
RECHARGE ENHANCEMENT STUDY  
FEASIBILITY ASSESSMENT

FIGURE 2.1-2



Additional environmental and socioeconomic concerns include the possible effects of the project on Bracken Bat Cave, believed to be the world's largest bat roost, and Natural Bridge Caverns located within two miles of the recharge project. Natural Bridge Caverns receives in excess of 300,000 visitors annually. Concerns regarding the effects of a proposed recharge project on Cibolo Creek have been raised previously.

#### 2.1.4 Water Quality and Treatability

[To be completed in subsequent phases of study.]

#### 2.1.5 Engineering and Costing

Recharge pool capacities ranging from 1,000 to 50,000 acft were evaluated for the Cibolo Creek project. All four conceptual dam designs presented in Appendix A were utilized for the range of capacities examined. Table 2.1-1 provides pertinent physical, hydrologic, and cost data for the five recharge pool capacities evaluated at the proposed Cibolo Creek site. A recharge pool capacity of 1,000 acft impounded by a roller compacted concrete (RCC) channel dam was determined to be the optimum size for the site, based strictly on the minimum unit cost of recharge enhancement under average conditions. The minimum unit cost for drought conditions occurs at a recharge pool capacity of 10,000 acft impounded by a composite RCC/embankment dam. As will be presented later during the recharge enhancement program development in Section 3.0, the recommended project size for the Cibolo Creek site is the 10,000 acft capacity.

The composite dam design is the most cost effective dam/spillway type for the recommended size at the Cibolo Creek site. The left abutment (looking in the downstream direction) is a near-vertical exposed rock bluff (Edwards limestone) with virtually no soil cover. The top of the proposed dam (elevation 900.9 ft-msl) coincides with the top of the bluff at the dam site. The right abutment slopes upward gently and consistently away from the creek. It appears to be coated with a relatively thin layer of alluvium most, if not all, of the way to the top of the dam. At the dam site, there is a terrace about 300 feet wide extending to the right of the creek channel. The terrace is presumed to be about 10 feet thick and likely contains mostly coarse gravel with boulders. On the right side the terrace merges indistinctly with the slope of the right abutment.

**Table 2.1-1  
Cibolo Creek Project Cost and Data Summary**

<b>Physical Data</b>					
Recharge Pool:					
Capacity (acft)	1,000	5,000	10,000	25,000	50,000
Surface Area (ac)	84	269	476	948	1,621
Elevation (ft-msl)	834.4	858.2	871.9	893.6	913.0
Spillway Elevation (ft-msl)	834.4	858.2	871.9	898.6	918.0
Spillway Width (ft)	410	1,000	1,000	900	1,000
25-Year Flood Pool <sup>1</sup> :					
Elevation (ft-msl)	848.4	866.5	880.1	902.9	908.2
Surface Area (ac)	183	389	618	1,287	1,466
50-Year Flood Pool <sup>1</sup> :					
Elevation (ft-msl)	850.3	867.8	881.3	905.2	914.8
100-Year Flood Pool <sup>1</sup> :					
Elevation (ft-msl)	851.9	868.9	882.4	907.2	919.7
Surface Area (ac)	211	429	672	1,435	1,865
Dam Type	RCC Channel	RCC Gravity	Composite	Embankment	Embankment
Top of Dam Elevation (ft-msl)	834.4	887.4	900.9	931.7	948.2
Streambed Elevation (ft-msl)	804.0	804.0	804.0	804.0	804.0
<b>Hydrologic Data</b>					
Recharge Enhancement (acft/yr):					
Drought Conditions	382	932	1,485	2,469	2,469
Average Conditions	3,787	7,925	9,733	12,134	12,849
Median Conditions	1,814	4,085	4,089	4,086	4,086
Drought Average Annual Streamflow Reduction at Saltwater Barrier	129	313	500	834	834
<b>Summary of Project Costs</b>					
Dam, Spillway, and Appurtenant Works	\$1,957,001	\$5,408,578	\$7,621,052	\$12,284,547	\$10,841,326
Road Relocations	\$0	\$0	\$0	\$37,800	\$37,800
Land Acquisition	\$591,000	\$1,277,000	\$2,035,000	\$4,583,000	\$5,616,500
Environmental Mitigation	\$67,853	\$217,291	\$384,500	\$765,769	\$1,309,400
Engineering, Legal, Financial, and Misc.	<u>\$523,171</u>	<u>\$1,380,574</u>	<u>\$2,008,110</u>	<u>\$3,534,223</u>	<u>\$3,561,005</u>
<b>Total Capital Cost</b>	<b>\$3,139,025</b>	<b>\$8,283,443</b>	<b>\$12,048,662</b>	<b>\$21,205,339</b>	<b>\$21,366,031</b>
Annual Capital Cost (25 years @ 8% Interest)	\$294,127	\$776,159	\$1,128,960	\$1,986,940	\$2,001,997
Operations and Maintenance (annual)	\$8,672	\$24,336	\$35,264	\$58,658	\$59,643
Downstream Impacts (annual)	<u>\$387</u>	<u>\$939</u>	<u>\$1,500</u>	<u>\$2,502</u>	<u>\$2,502</u>
<b>Total Annual Cost</b>	<b>\$303,185</b>	<b>\$801,433</b>	<b>\$1,165,724</b>	<b>\$2,048,100</b>	<b>\$2,064,143</b>
Annual Cost/Unit Recharge Enhancement:					
Drought Conditions (\$/acft/yr)	\$794	\$860	\$785	\$830	\$836
Average Conditions (\$/acft/yr)	\$80	\$101	\$120	\$169	\$161

<sup>1</sup>Flood pools based on reservoirs being empty at beginning of flood.

As shown in Figure 2.1-3, the dam centerline geometry is suited to an RCC overflow spillway in the creek channel with an embankment dam connecting the RCC spillway section to the right abutment. A spillway width of 1,000 feet is required to safely pass the probable maximum flood (PMF). This configuration results in the RCC overflow section being about 68 feet high measured from the low point of the creek. The height to the top of dam would be approximately 97 feet. The maximum flood depth through the spillway would be approximately 10 feet during the 100-year flood and 29 feet during the PMF.

Sufficient construction materials appear to be available within the immediate project vicinity to construct the recommended dam type. Aggregates for producing RCC are likely to be present in the alluvium terraces at and upstream of the dam site in the recharge pool area. Additionally, aggregates could be crushed from the abundant Edwards limestones at the site. Earth and rock fill materials for the embankment dam could be secured from the terrace deposits, alluvial materials blanketing the right abutment, required excavations, and/or quarry operation in the recharge pool area. Clay material for the core of the embankment dam may be in limited supply and may need to be imported from sources outside the project area.

The recommended size recharge pool at the Cibolo Creek site would not require any road relocations. The two largest size recharge pool capacities considered at this site would impact an existing residential development beyond the left abutment in a topographic saddle that would be excavated to create an auxiliary spillway.

Much of the data contained in Table 2.1-1 is also presented graphically in Figure 2.1-4. The recommended recharge pool capacity of 10,000 acft results in 9,733 acft/yr of recharge enhancement under average conditions at a unit cost of \$120/acft/yr. Recharge under drought conditions would be increased by 1,485 acft/yr at a unit cost of \$785/acft/yr.

A graph illustrating the annual natural recharge and the recharge enhancement resulting from development of the recommended size Cibolo Creek project is shown in Figure 2.1-5 for the 56-year period of record from 1934 through 1989.

Figure 2.1-6 illustrates the typical performance of direct percolation recharge projects located within the Edwards Aquifer recharge zone. The primary purpose of these recharge projects is to store flood flows and allow the water to percolate over time through cracks and fissures into the aquifer. The figure indicates that, for the historical period simulated, the

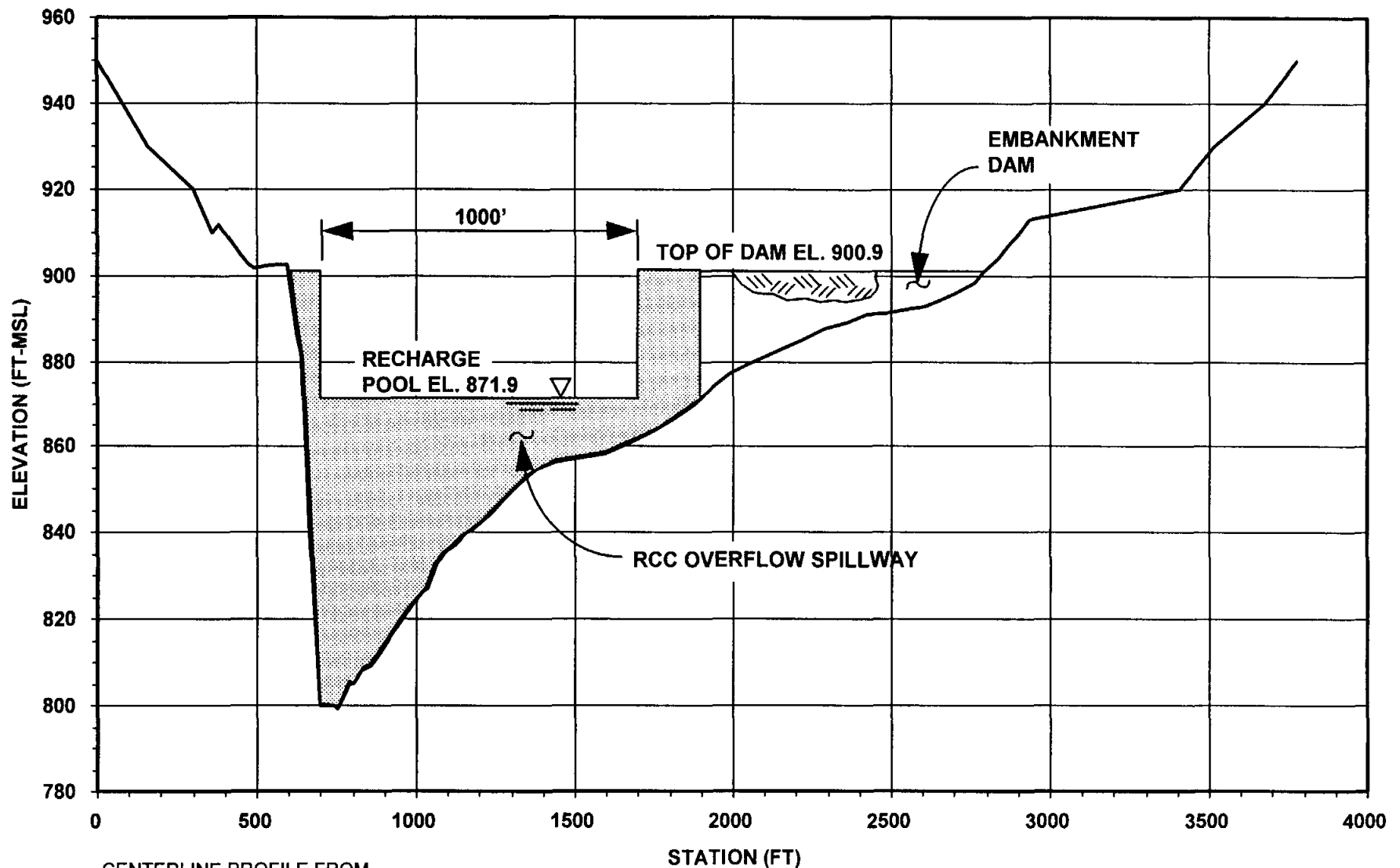

CENTERLINE PROFILE FROM  
 UNITED AERIAL MAPPING, 1994  
 PROFILE IS SHOWN LOOKING DOWNSTREAM

TRANS TEXAS WATER PROGRAM /  
 WEST CENTRAL STUDY AREA

**CIBOLO CREEK PROJECT  
 CENTERLINE PROFILE**

GUADALUPE - SAN ANTONIO RIVER BASIN  
 RECHARGE ENHANCEMENT STUDY  
 FEASIBILITY ASSESSMENT



HDR Engineering, Inc.

FIGURE 2.1-3

RECHARGE ENHANCEMENT SUMMARY

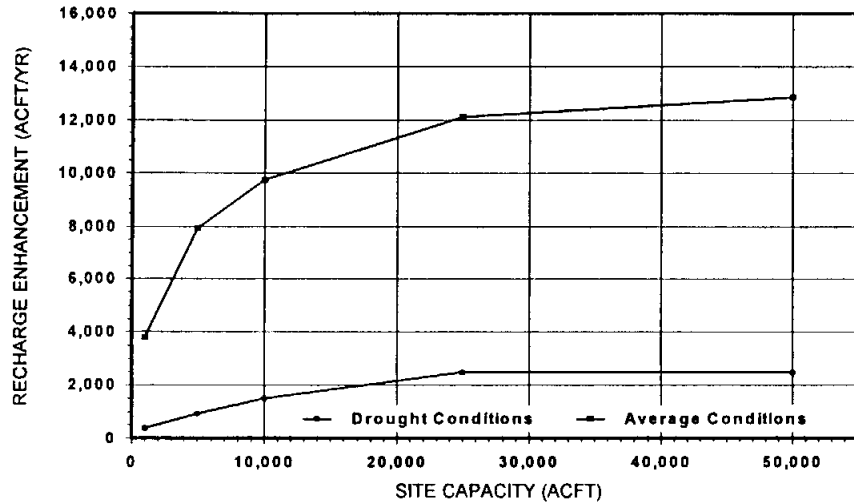

DOWNSTREAM IMPACT SUMMARY

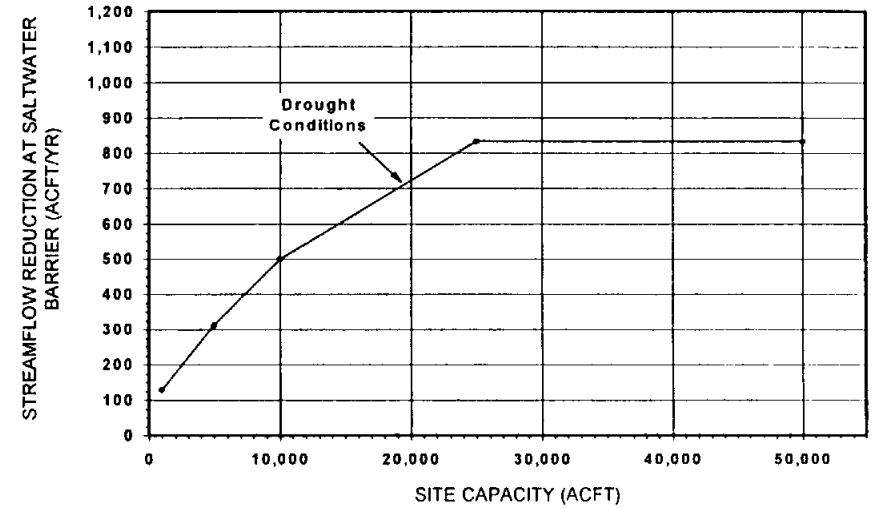

RECHARGE PROJECT COST SUMMARY

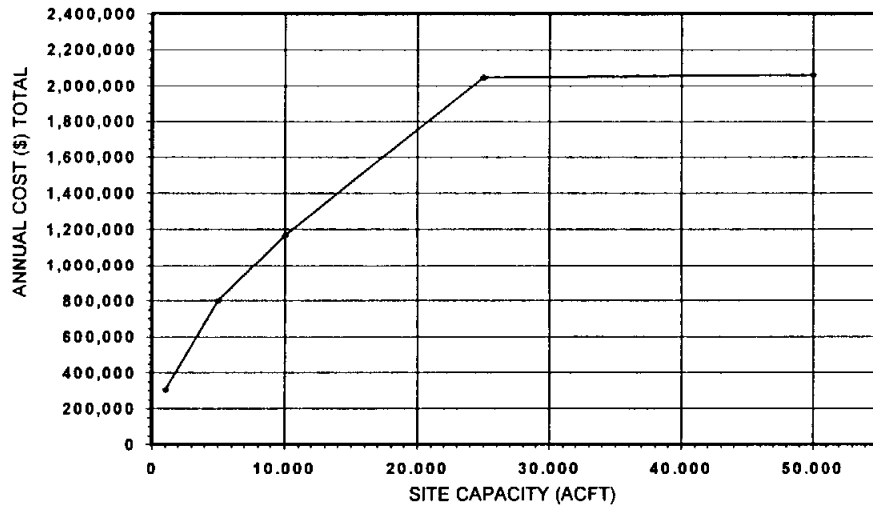

RECHARGE PROJECT OPTIMIZATION SUMMARY

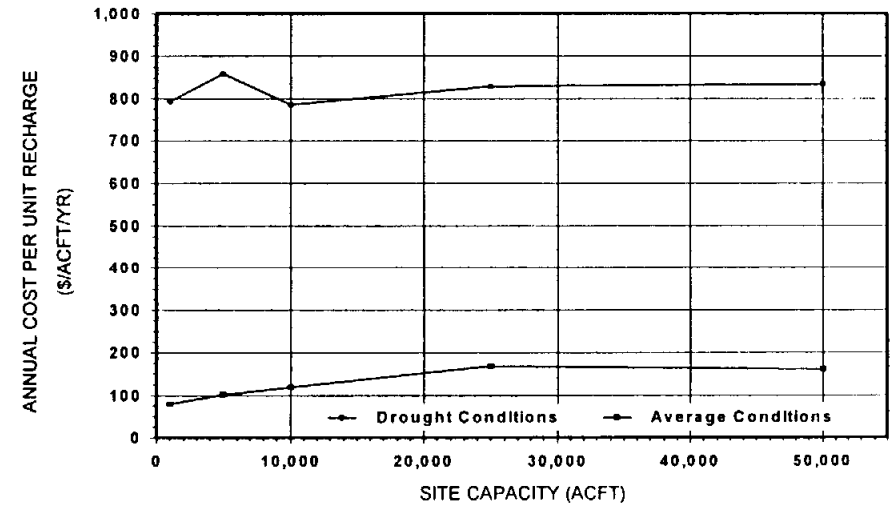

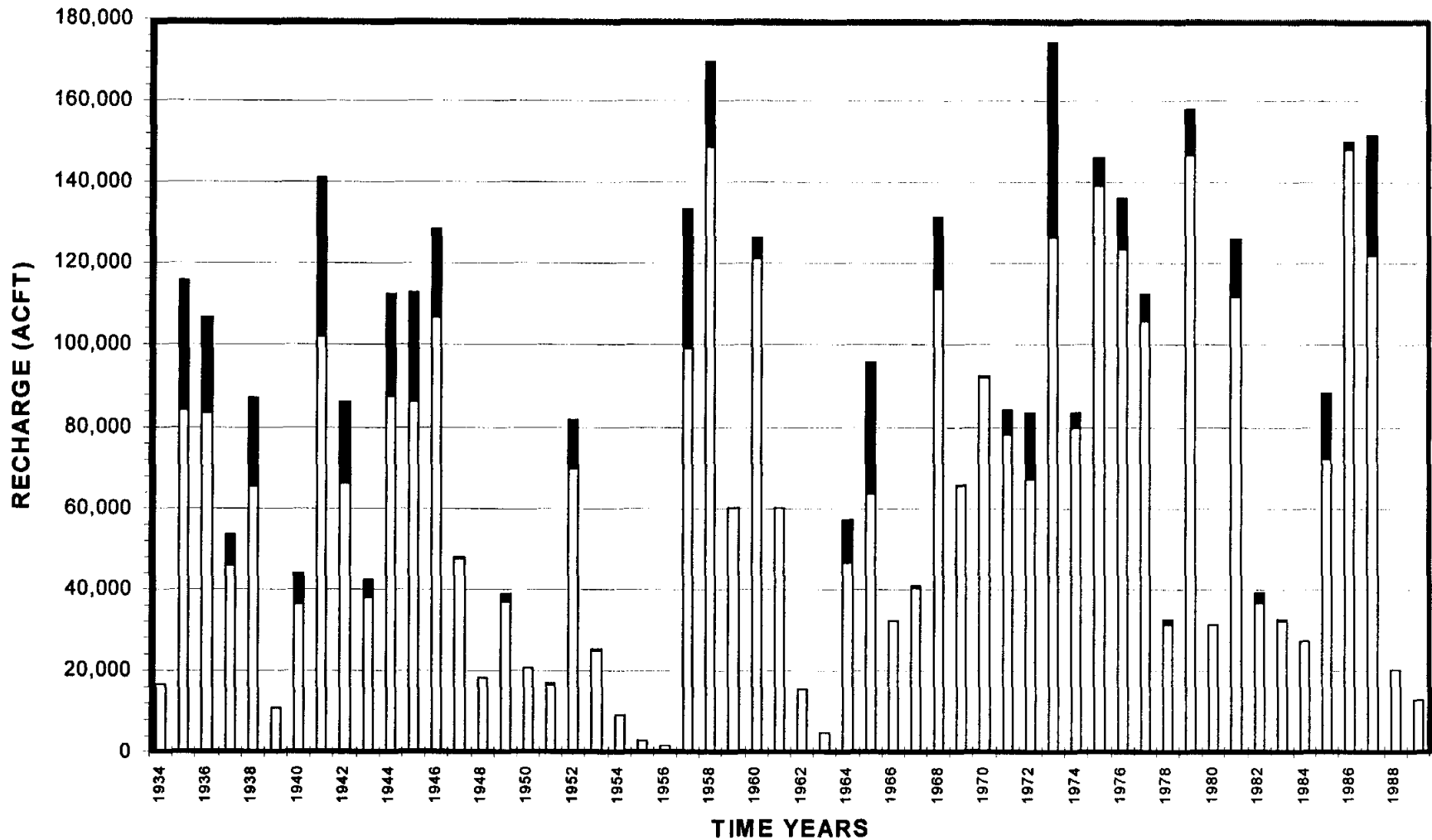

□ NATURAL RECHARGE

■ RECHARGE ENHANCEMENT

TRANS TEXAS WATER PROGRAM /  
WEST CENTRAL STUDY AREA

**CIBOLO CREEK PROJECT  
ANNUAL RECHARGE**

GUADALUPE - SAN ANTONIO RIVER BASIN  
RECHARGE ENHANCEMENT STUDY  
FEASIBILITY ASSESSMENT



HDR Engineering, Inc.

FIGURE 2.1-5

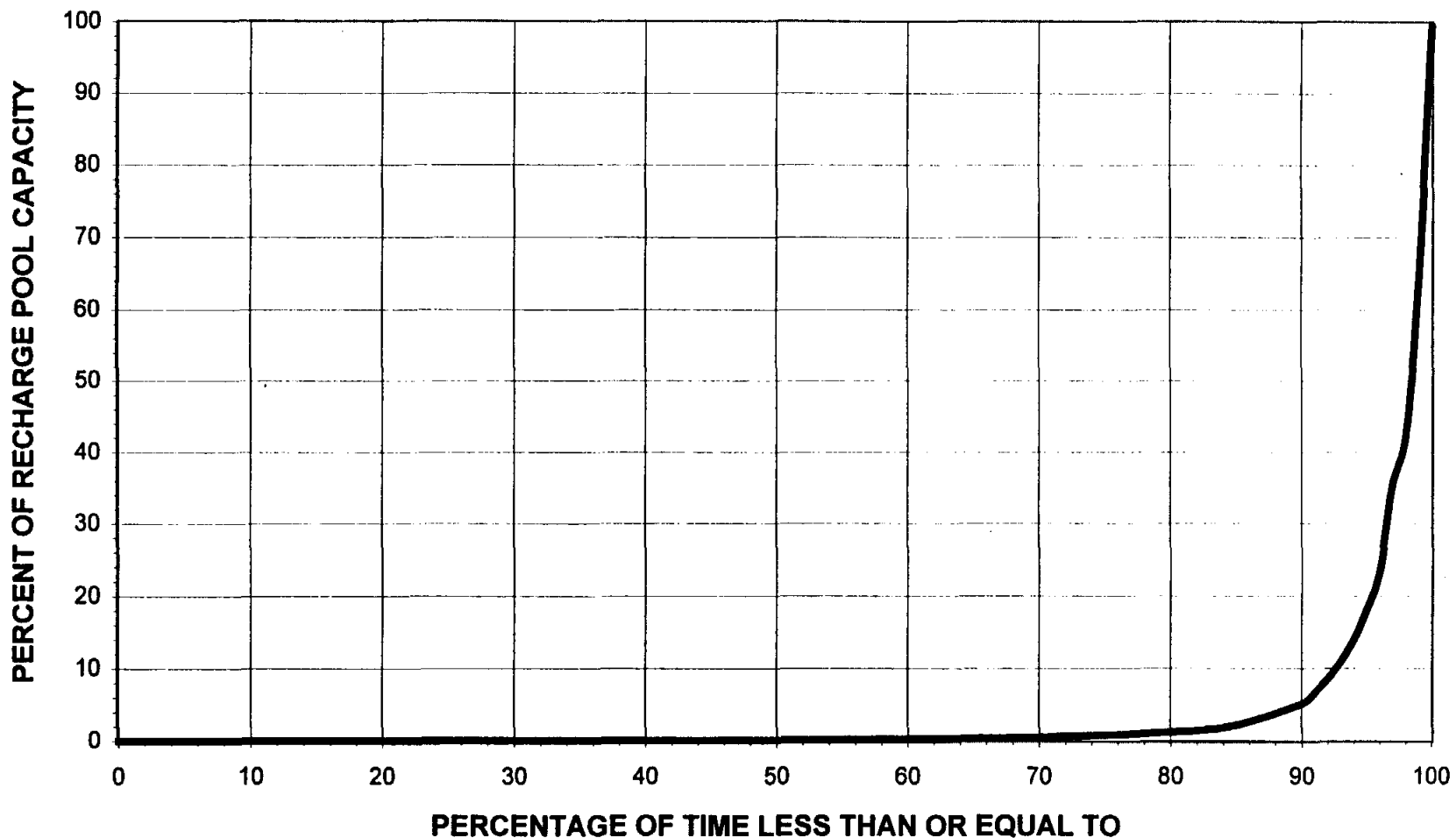

RECHARGE POOL CAPACITY = 10,000 ACFT

TRANS TEXAS WATER PROGRAM /  
WEST CENTRAL STUDY AREA

**CIBOLO CREEK PROJECT  
STORAGE FREQUENCY**

GUADALUPE - SAN ANTONIO RIVER BASIN  
RECHARGE ENHANCEMENT STUDY  
FEASIBILITY ASSESSMENT



HDR Engineering, Inc.

FIGURE 2.1-6

recharge pool would be empty 70 percent of the time. Approximately 98 percent of the time, storage would be less than 50 percent of the design capacity.

### 2.1.6 Implementation Issues

#### Requirements Specific to Surface Recharge Structures

1. It will be necessary to obtain these permits:
  - a. TNRCC Water Right and Storage Permit.
  - b. U.S. Army Corps of Engineers Sections 10 and 404 dredge and fill permits for the reservoir.
  - c. GLO Sand and Gravel Removal permits.
  - d. GLO Easement for use of state-owned lands.
  - e. Coastal Coordination Council review.
  - f. TPWD Sand, Gravel, and Marl permit.
2. Permitting, at a minimum, will require these studies:
  - a. Bay and estuary inflow impact.
  - b. Habitat mitigation plan.
  - c. Environmental studies.
  - d. Cultural resource studies.
  - e. Study of impact on karst geology organisms from sustained recharge.
  - f. Other environmental studies.
3. Land will need to be acquired through either negotiations or condemnation.
4. Detailed field investigation of the reservoir area to determine natural and expected recharge rates. Detailed geohydrological investigations to determine if recharge will significantly affect water levels at Natural Bridge Caverns or Bracken Bat Cave.



## **2.2 Lower Blanco Project with Diversion to Upper San Marcos Watershed (L-21B)**

### **2.2.1 Description of Alternative**

The Lower Blanco project is located on the Blanco River approximately 2.3 miles upstream of the USGS streamflow gaging station at Kyle (08171300). The drainage area upstream of the gaging station is approximately 412 square miles. This project is a Type 2 (direct recharge) project which captures flood flows and recharges the aquifer via direct percolation through the rock fractures and surface soils. Figure 2.2-1 shows the location of the proposed project.

A major component of the recharge enhancement associated with this project is the addition of a pipeline to divert water from the recharge pool west to the upper San Marcos watershed. There are three Soil Conservation Service/Flood Retarding Structures (SCS/FRS) in the upper San Marcos River watershed whose headwaters are in close proximity to the Lower Blanco project. Discussions with land owners adjacent to the SCS/FRS dams and with the local SCS Conservationist indicate that water impounded by these structures drains quickly below their service spillways, recharging the Edwards Aquifer. To take advantage of this recharge capability, simulations of the Lower Blanco project included the diversion of water to three of these SCS/FRS pools. In order to preserve the flood control function of these structures and protect the area downstream, it was assumed that only the sediment pool storage (that volume below the service spillway) would be available for use as a recharge pool. Observations indicate that the sediment pools in these structures drain (recharge) in seven to ten days. Therefore, it was assumed that the maximum volume of water that could be diverted into the three SCS/FRS projects was equal to a volume that would fill the combined sediment pool of the three structures twice in a given month. This resulted in a diversion rate equal to 1,048 acft per month. Figure 2.2-2 shows the approximate locations of the Lower Blanco Project, existing upper San Marcos SCS/FRS sites, and diversion pipeline.

The Lower Blanco site is located near the downstream edge of the Edwards Aquifer recharge zone on the Blanco River approximately three miles west of Kyle in eastern Hays County. The proposed dam centerline is approximately 10,000 feet downstream of a prominent

(This page intentionally left blank.)

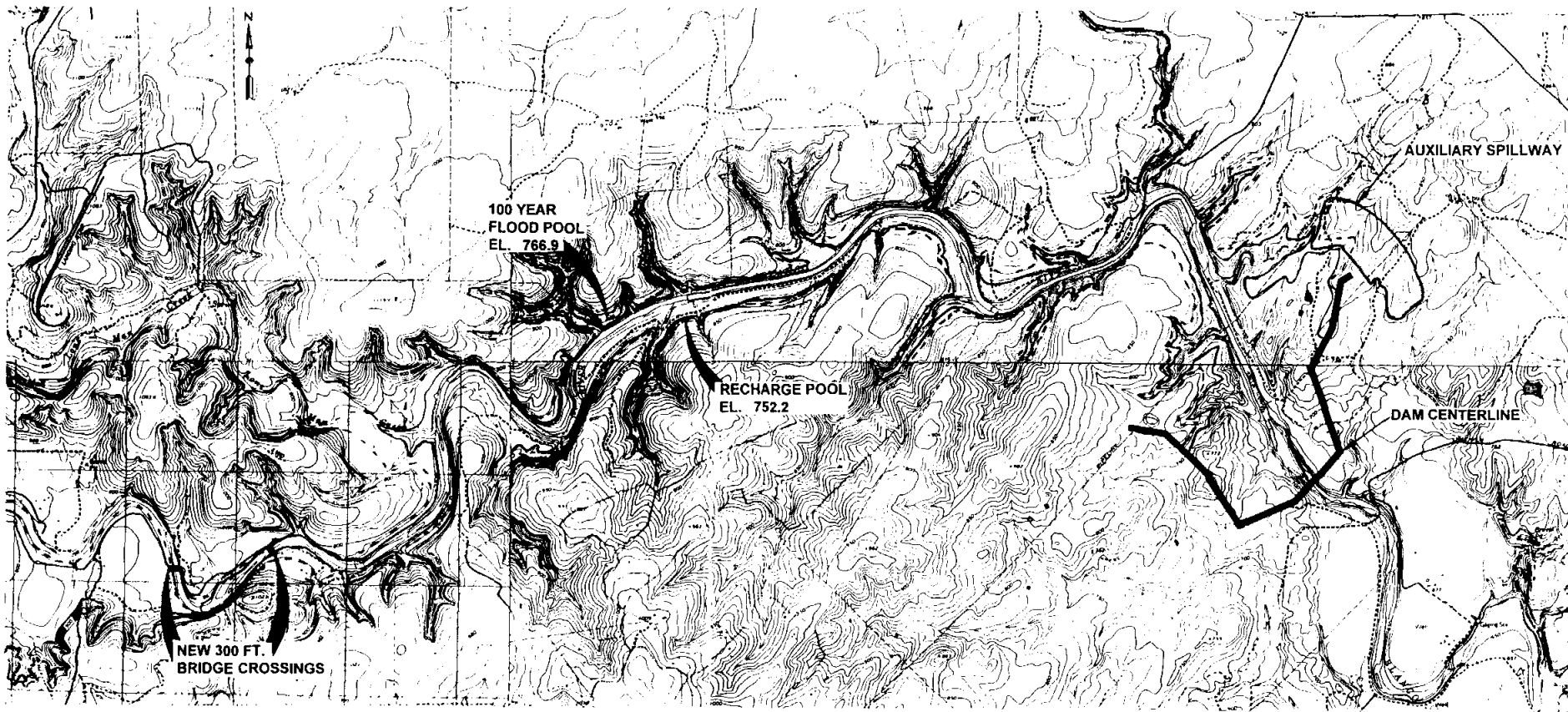

GUADALUPE - SAN ANTONIO RIVER BASIN  
 RECHARGE ENHANCEMENT STUDY  
 FEASIBILITY ASSESSMENT

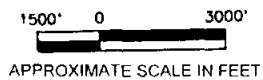

TRANS TEXAS WATER PROGRAM /  
 WEST CENTRAL STUDY AREA





**LOWER BLANCO PROJECT  
 SITE MAP**

HDR Engineering, Inc.

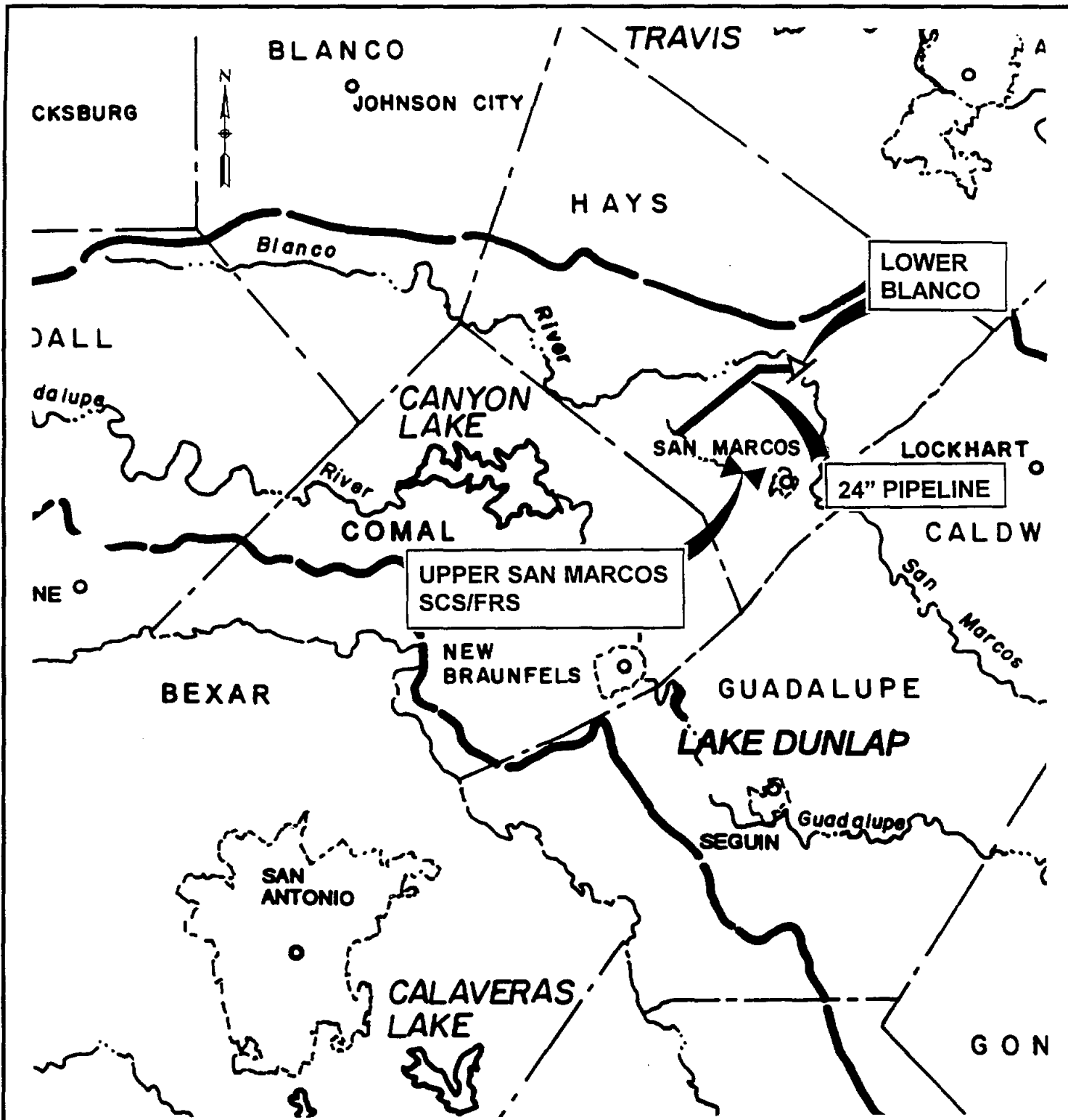
FIGURE 2.2-1



-  PROPOSED RECHARGE PROJECT
-  EXISTING SCS/FRS RESERVOIRS

GUADALUPE - SAN ANTONIO RIVER BASIN  
 RECHARGE ENHANCEMENT STUDY  
 FEASIBILITY ASSESSMENT



HDR Engineering, Inc.

TRANS TEXAS WATER PROGRAM /  
 WEST CENTRAL STUDY AREA

LOWER BLANCO PROJECT  
 DIVERSION PIPELINE

FIGURE 2.2-2

bend in the river where Halifax Creek joins the Blanco River (see Figure 2.2-1). The elevation of the creek bed at the proposed dam centerline is estimated to be 647 ft-msl, based on the USGS 7.5 minute topographic map. The drainage area above the proposed dam site is 409 square miles.

The proposed dam and recharge pool is located entirely on private property; public access is non-existent, with the exception of floating the river during higher flows. Landowner permission to access the proposed dam site was never granted to the Edwards Aquifer Authority (EAA). The feasibility assessment of this proposed recharge project has been performed using available mapping without the benefit of a site reconnaissance by the project team.

### 2.2.2 Recharge Enhancement Hydrology

The Lower Blanco project recharge pool capacities analyzed in this study were operated on a daily timestep, honoring all downstream existing water rights, and assuming environmental flow requirements. A unique recharge rate curve was developed for this site (see Figure A.2-4, in Appendix A) and recharge at the site included natural recharge upstream and downstream of the project, direct percolation in the recharge pool, and recharge of water diverted to the upper San Marcos watershed. Details of the recharge reservoir operations, development of the recharge rate curves, and environmental flow requirements used are discussed in Appendix A.

Recharge pool capacities ranging from 3,500 to 50,000 acft were evaluated for the Lower Blanco project. Two pipeline sizes for diversions to the upper San Marcos watershed were analyzed, a 24-inch and a 36-inch diameter pipe. Long-term average recharge enhancement (1934-89) ranged from 22,129 acft/yr for the 3,500 acft project size to 49,766 acft/yr for the largest size (50,000 acft), assuming a 24-inch diversion pipeline to the upper San Marcos watershed. Drought average recharge enhancement (1947-56) with a 24-inch pipeline was found to range from 9,789 acft/yr to 22,490 acft/yr for the smallest and largest sizes, respectively. The 24-inch pipeline was assumed to deliver 1,048 acft per month at a steady, continuous rate to the upper San Marcos watershed. The 36-inch pipeline, while only one-foot larger in diameter, could deliver twice as much water in a month. Therefore, the larger pipeline may offer some operational flexibility in the management of diversions to the adjacent watershed. Analyses in this study showed that when a maximum monthly diversion limitation of 1,048 acft per month is enforced, the additional enhancement gained from a 36-inch pipeline (as compared to a 24-inch)

is minimal. For the 50,000 acft storage capacity Lower Blanco project (the size included in the recommended program of recharge enhancement projects presented in Section 3.0), the additional long-term average recharge enhancement gained by operating a 36-inch pipeline is only 52 acft/yr (0.1 percent). The long-term and drought average annual recharge enhancements for the 50,000 acft project size with a 24-inch diversion pipeline were found to be 49,766 acft per year and 22,490 acft per year, respectively. This includes long-term and drought average annual diversion of 10,936 acft/yr and 7,924 acft/yr, respectively, to the upper San Marcos watershed. The recharge pool sizes were also analyzed assuming no environmental flow passage criteria. The resulting recharge enhancement for the 50,000 acft project size increased 2,651 acft/yr (11.8 percent) under drought conditions and 1,915 acft/yr (3.8 percent) under long-term conditions.

### 2.2.3 Environmental Issues

The Lower Blanco project is a proposed Type 2 (direct recharge) impoundment on the Blanco River. The dam centerline would be located downstream of the Halifax Creek confluence in Hays County. The Blanco River and its tributaries in this reach are deeply incised into rocky canyons that dissect the rolling Edwards Plateau upland. The upland portions of this site are predominantly covered with live oak-Ashe juniper parks and woods, while pecan and bald cypress mark a narrow floodplain and riparian corridor. The surrounding area is primarily used for cattle ranching.

The Lower Blanco project is located in the Balcones Fault Zone, on the Balcones Escarpment, upstream of the Blackland Prairie.<sup>20,21</sup> The Balcones Escarpment is the southern and eastern end of the uplifted Edwards Plateau. It is characterized by a complex of porous, faulted limestones in streambeds, sinkholes, and fractures which allow substantial volumes of water to flow into the Edwards Aquifer (see Appendix B, Section 2.2 Habitats and Biogeography). The Balcones Fault is a transitional zone between the Edwards Plateau and the Blackland Prairie and forms unique habitats favorable to a number of rare and protected species. The common isolated

---

<sup>20</sup> Omernik, J.M. 1987. Ecoregions of the conterminous United States. *Annals of the Association of American Geographers* 77:11-125.

<sup>21</sup> Gould, F.W. 1962. *The Grasses of Texas*. Texas A&M University Press. College Station, Texas.

springs and caves favor endemism, where organisms become narrowly adapted to the stable, local environment.

The surface geology of the Lower Blanco site is Cretaceous Fredericksburg Group and Fluvial Terrace deposits.<sup>22</sup> The soil units that have been deposited in the streambed and floodplain are from the Tarrant Association (gently undulating), Doss Silty Clay (1 to 5 percent slopes), Ekrant-Rock Outcrop Complex (steep), Comfort-Rock Outcrop Complex (undulating), Boerne Fine Sandy Loam (1 to 3 percent slopes), Rumble-Comfort association (undulating), Lewisville Silty Clay (1 to 3 percent slopes), and Medlin-Ekrant Association (hilly), and Krum Complex.<sup>23</sup>

Land uses, habitat types, and wetland occurrences within the study area were identified and evaluated using available literature and a variety of other sources, including the Texas Natural Resources Information System's aerial photography and map database; Texas Highway Department aerial photography; Texas Parks and Wildlife Department (TPWD), Resource Protection Division's data and mapping files for endangered, protected and sensitive resources; Texas Organization for Endangered Species (TOES) listings of endangered, protected and sensitive resources; U.S. Fish and Wildlife Service (USFWS) National Wetland Inventory (NWI) maps; information available from the Edwards Aquifer Research and Data Center; USGS library resources; Texas Natural Resource Conservation Commission (TNRCC) publications and library; consultant reports; and the general biological literature, particularly descriptions of the habitat requirements of species listed as Endangered or Threatened by either the U.S. Department of the Interior or the State of Texas. This database, including archeological sites, significant environmental features, state natural areas, protected species and potential wetland areas is maintained at Paul Price Associates, Inc. on USGS 7.5 minute quadrangles.

The land located within the proposed project area is predominantly used for rangeland and wildlife habitat, although there are small areas that can be used for pasture and cropland.<sup>24</sup> Hays County ranked 196th in 1985 in agricultural receipts, of which 77 percent were derived from

---

<sup>22</sup> Fisher, W.L. 1974. Geologic Atlas of Texas: Austin Sheet. Bureau of Economic Geology. The University of Texas at Austin. Austin, Texas.

<sup>23</sup> Batte, C.D. 1984. Soil Survey of Comal and Hays Counties, Texas. United States Department of Agriculture Natural Resource Conservation Service.

<sup>24</sup> Price, P. 1994. Field notes from a visit to the site. Paul Price Associates, Inc. Austin, Texas. August 1-2, 1994.

livestock and livestock products including beef cattle, sheep, wool, angora goats, and mohair.<sup>25</sup> About 8 percent of the agricultural land is used for harvested crops and less than 1 percent is irrigated. Primary crops include hay, sorghum, and corn for feed. Primary vegetables, fruits, and nuts include tomatoes and potatoes. In 1987, Hays County ranked 37th in the state in retail sales volume. The businesses and industries employing the most people included restaurants, manufacturing, contract construction, health services, and finance. Non-farm income in 1986 totaled \$6.7 million.

Since the proposed Upper and Lower Blanco project sites are within a few miles of each other, it can be assumed that similar vegetation exists on both sites. Due to a lack of landowner permission, the Lower Blanco project site has not been surveyed. It should contain vegetation similar to that found on the Upper Blanco project site: cypress (*Taxodium distichum*), cottonwoods (*Populus deltoides*), and pecan (*Carya illinoensis*) trees in the bottomland adjacent to the river, changing to an oak (*Quercus* spp.) and cedar elm (*Ulmus crassifolia*) canopy upslope from the first river terrace on the left bank and Ashe juniper (*Juniperus ashei*), American elm (*U. americana*), live oaks (*Q. virginiana*), box elder (*Acer negundo*), and hackberry (*Celtis laevigata*) dominating the right bank canopy. The area for the proposed project size examined contains 351.5 acres of woods, 344.0 acres of parks, 162.3 acres of brush and 73.1 acres of grassland (Appendix B, Table 4). Wetlands cover 145.1 acres of the project area. The wetlands are all classified open water or diked lower perennial riverine habitat (Appendix B, Table 4).

Based on the location of the proposed project site, the endangered, threatened, or important species that might occur in the proposed project site could include Cagle's map turtle (*Graptemys caglei*), Black-capped vireo (*Vireo atricapillus*), Golden-cheeked warbler (*Dendroica chrysoparia*), various *Eurycea* species (*E. sp. 7*, *E. pterophila*), and in subterranean karst and springs, the Blanco blind salamander (*E. robusta*) which was found in the Blanco River only once during a gravel quarry operation (Appendix B, Tables 1 and 2). See Appendix B, Section 2.5 for discussions of the potential protected species of the area. TPWD data files show that the Guadalupe bass, a TOES Watch List species, is the only important species reported in or near the proposed Lower Blanco site (Appendix B, Table 5). Because of very limited site

---

<sup>25</sup> Clements, J. 1988. Texas Facts: A Comprehensive Look at Texas Today County by County. Clements Research II, Inc. Dallas, Texas.



information, an intensive survey of the project area would be required to accurately describe the habitats within the project area and determine the presence of any associated endangered, threatened or important species. The nature of the geology of the area also requires the characterization of karst features by a karst biologist to determine the presence or absence of any associated protected or endangered species (see Appendix B, Sections 2.2 and 2.3 for karst discussions).

Modeling flows of the Blanco River at Kyle indicated that the 50,000 acft recharge project would decrease the annual average flow from 90,218 acft/yr without the project to 38,640 acft/yr with implementation, a 57 percent decrease. Monthly median flows, without project implementation, ranged from 1,328 acft in August to 7,150 acft in May, while monthly median flows with the project ranged from 174 acft in August to 2,692 acft in May (see Figure 2.2-3). Monthly median decreases ranged from 58 to 90 percent. Decreases in median flows were distributed fairly evenly throughout the months of the year, with the greatest percentage decreases generally being in low flow months. The considerable reductions in projected streamflow below the recharge project may adversely affect some biological communities downstream, especially during low flow months.

A search of the database at the Texas Archeological Research Laboratory (TARL) revealed numerous archeological sites recorded within the general area of the proposed recharge project site, although none were within the proposed periodic inundation area. A total of 19 sites are located in the vicinity of the project area including: 8 lithic procurement areas, 7 open camps, 1 rock shelter, 1 19th century homestead and 2 sites of unknown use. Prior to inundation, it must be determined if any cultural properties are located within the project area by an on-site survey. Once all cultural properties within the project area are identified, they will undergo preliminary assessment, during the survey, to determine the significance and potential for eligibility in the Register of Historic Places. Because the assessment methods used during the survey are limited in their ability to determine significance potential, some sites may need to be subjected to more extensive test-level investigations before their eligibility can be adequately determined. Once cultural resource properties are determined to be eligible, they must either enter mitigation through avoidance or undergo scientific data recovery (see Appendix B, Section 2.7).

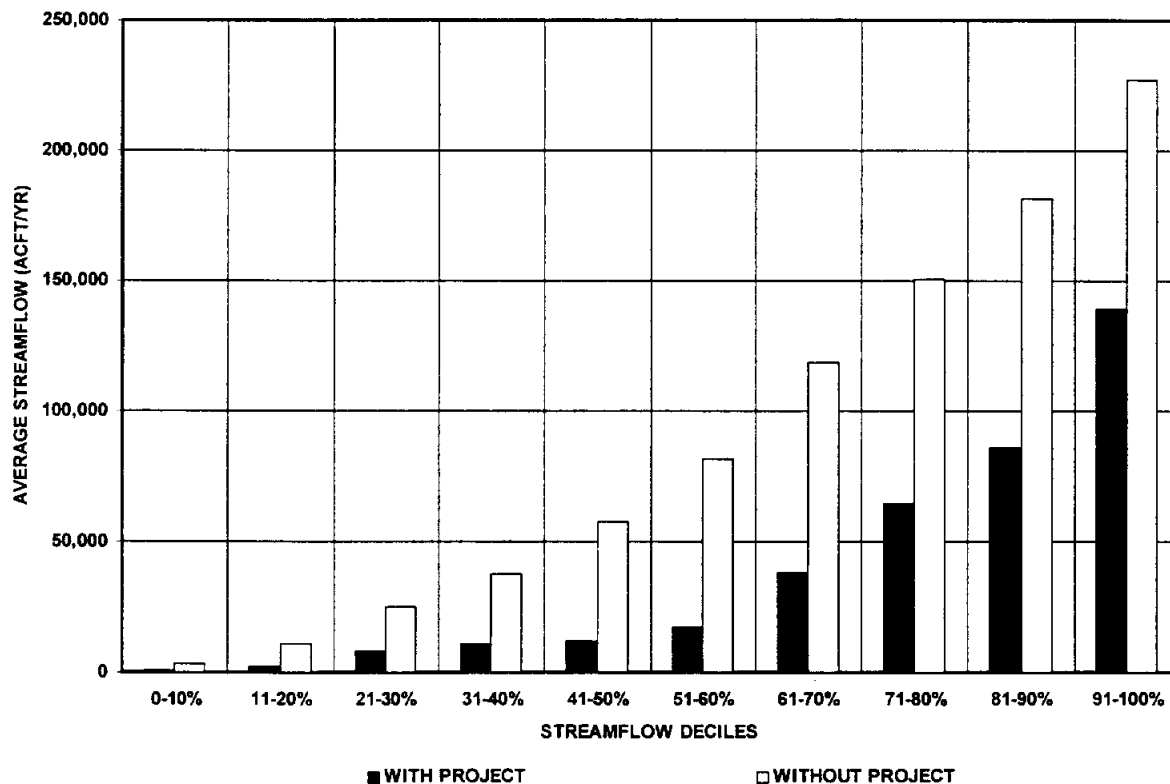
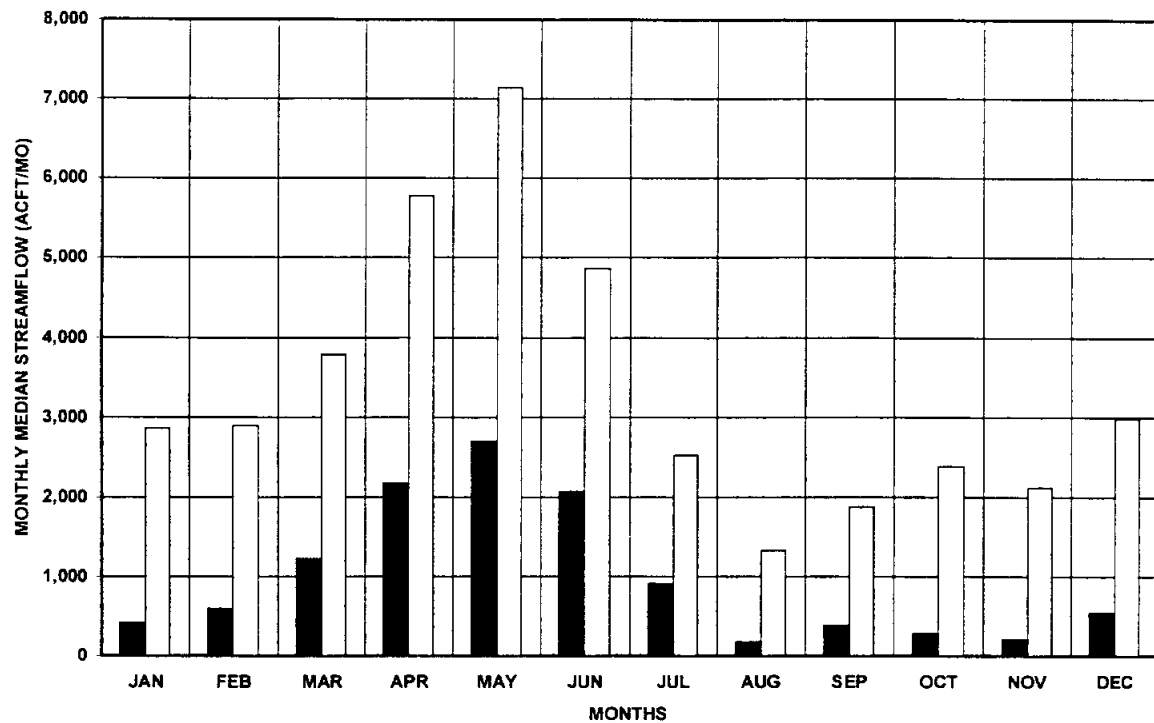

NOTE: STATISTICS BASED ON  
1934-89 HISTORICAL PERIOD

GUADALUPE - SAN ANTONIO RIVER BASIN  
RECHARGE ENHANCEMENT STUDY  
FEASIBILITY ASSESSMENT



HDR Engineering, Inc.

TRANS TEXAS WATER PROGRAM /  
WEST CENTRAL STUDY AREA

**LOWER BLANCO PROJECT  
CHANGES IN STREAMFLOW**  
BLANCO RIVER AT KYLE

FIGURE 2.2-3

In summary, the environmental concerns associated with this proposed recharge project include evaluation of the oak-Ashe juniper woods and parks within the project area for utilization by protected species, evaluation of the impact of inundation of Guadalupe bass habitat on this TOES species of concern, evaluation of the historic significance of cultural resources sites, and evaluation of the possible impacts of changing streamflows in the perennial lower Blanco River (Appendix B, Table 6). Estimated environmental related costs for the Lower Blanco project can be found in Appendix B, Table 7. These estimates are based on a recharge pool level of 740 ft-msl. Environmental report costs include baseline surveys, a comprehensive Environmental Assessment, and support for necessary permitting.

#### 2.2.4 Water Quality and Treatability

[To be completed in subsequent phases of study.]

#### 2.2.5 Engineering and Costing

Recharge pool capacities ranging from 3,500 to 50,000 acft were evaluated for the Lower Blanco project. Three of the four conceptual dam designs presented in Appendix A were utilized for the range of capacities examined. Table 2.2-1 provides pertinent physical, hydrologic, and cost data for the five recharge pool capacities evaluated at the proposed Lower Blanco site. A recharge pool capacity of 3,500 acft impounded by a roller compacted concrete (RCC) channel dam was determined to be the optimum size for the site, based strictly on the minimum unit cost of recharge enhancement under average conditions. However, a second low point in the unit cost of recharge enhancement occurs at the 35,000 acft capacity. As will be presented later during the recharge enhancement program development in Section 3.0, the recommended project size for the Lower Blanco site is the 50,000 acft capacity. This size represents the maximum practical capacity of the site.

The embankment dam and side channel auxiliary spillway is the most cost effective dam and spillway configuration for the recommended size project at the Lower Blanco site. The proposed dam centerline forms a U-shape that stretches nearly three miles across a broad, relatively flat valley near the Balcones Escarpment to connect topographic high points to the northeast and southwest (see Figures 2.2-1 and 2.2-4). For the recommended project, a side-

**Table 2.2-1  
Lower Blanco Project (with 24" Diversion) Cost and Data Summary**

<b>Physical Data</b>					
<b>Recharge Pool:</b>					
Capacity (acft)	3,500	10,000	17,500	35,000	50,000
Surface Area (ac)	253	487	700	1,073	1,408
Elevation (ft-msl)	689.4	707.3	720.0	739.9	752.2
Spillway Elevation (ft-msl)	689.4	707.3	720.0	744.9	757.2
Spillway Width (ft)	1,241	1,400	1,350	1,800	1,500
<b>25-Year Flood Pool<sup>1</sup>:</b>					
Elevation (ft-msl)	697.9	715.7	728.6	751.9	763.5
Surface Area (ac)	355	625	849	1,397	1,811
<b>50-Year Flood Pool<sup>1</sup>:</b>					
Elevation (ft-msl)	699.0	716.9	729.8	753.2	765.2
<b>100-Year Flood Pool<sup>1</sup>:</b>					
Elevation (ft-msl)	700.1	718.2	731.1	754.6	766.9
Surface Area (ac)	383	669	894	1,498	1,932
Dam Type	RCC Channel	Composite	Composite	Embankment	Embankment
Top of Dam Elevation (ft-msl)	689.4	736.2	749.5	771.6	787.0
Streambed Elevation (ft-msl)	647.0	647.0	647.0	647.0	647.0
<b>Hydrologic Data</b>					
<b>Recharge Enhancement (acft/yr):</b>					
Drought Conditions	9,789	13,260	15,485	19,292	22,490
Average Conditions	22,129	28,477	33,555	42,904	49,766
Median Conditions	24,733	33,463	40,124	50,394	57,581
Drought Average Annual Streamflow Reduction at Saltwater Barrier	6,628	8,629	9,731	11,151	12,364
<b>Summary of Project Costs</b>					
Dam, Spillway, and Appurtenant Works	\$5,368,548	\$11,721,491	\$16,896,784	\$17,199,662	\$25,364,443
Pump Station and Pipeline	\$3,613,737	\$3,613,737	\$3,613,737	\$3,613,737	\$3,613,737
Road Relocations	\$0	\$0	\$0	\$516,000	\$1,032,000
Land Acquisition	\$3,865,167	\$6,965,167	\$8,612,667	\$12,467,667	\$15,547,667
Environmental Mitigation	\$1,603,492	\$2,943,049	\$4,162,390	\$6,297,667	\$8,215,409
Engineering, Legal, Financial, and Misc.	\$3,259,436	\$5,417,936	\$7,026,363	\$8,388,194	\$11,123,898
<b>Total Capital Cost</b>	<b>\$17,710,380</b>	<b>\$30,661,380</b>	<b>\$40,311,940</b>	<b>\$48,482,927</b>	<b>\$64,897,155</b>
Annual Capital Cost (25years @ 8% interest)	\$1,659,463	\$2,872,971	\$3,777,229	\$4,542,850	\$6,080,863
Operations and Maintenance (annual)	\$620,510	\$648,266	\$671,101	\$676,050	\$712,065
Downstream Impacts (annual)	\$19,884	\$25,887	\$29,193	\$33,453	\$37,092
<b>Total Annual Cost</b>	<b>\$2,299,856</b>	<b>\$3,547,124</b>	<b>\$4,477,523</b>	<b>\$5,252,353</b>	<b>\$6,830,020</b>
<b>Annual Cost/Unit Recharge Enhancement:</b>					
Drought Conditions (\$/acft/yr)	\$235	\$268	\$289	\$272	\$304
Average Conditions (\$/acft/yr)	\$104	\$125	\$133	\$122	\$137

<sup>1</sup>Flood pools based on reservoirs being 50% full at beginning of flood.

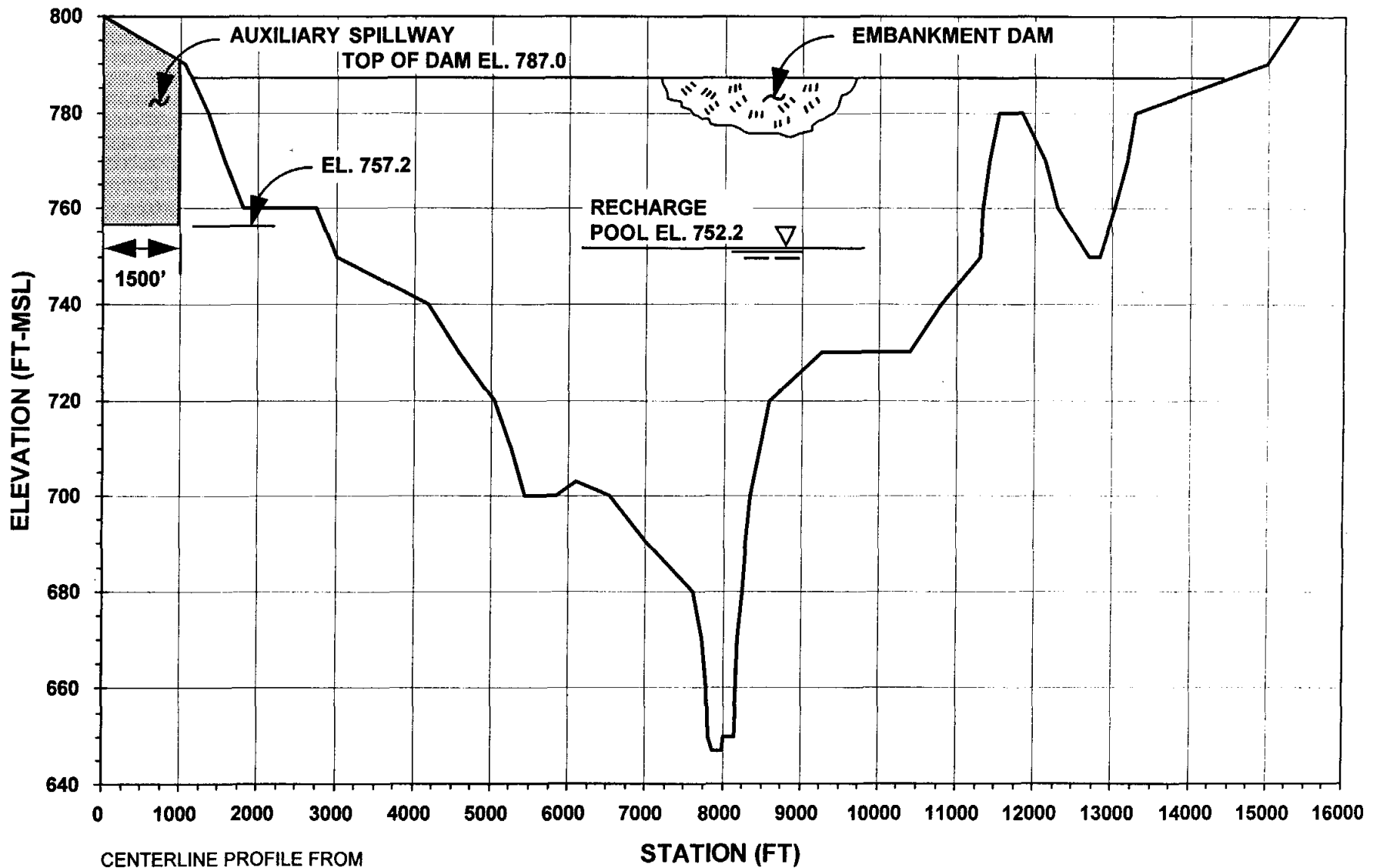

CENTERLINE PROFILE FROM  
 UNITED AERIAL MAPPING, 1994  
 PROFILE IS SHOWN LOOKING DOWNSTREAM

TRANS TEXAS WATER PROGRAM /  
 WEST CENTRAL STUDY AREA

**LOWER BLANCO PROJECT  
 CENTERLINE PROFILE**



HDR Engineering, Inc.

FIGURE 2.2-4

channel auxiliary spillway would be excavated beyond the left (looking downstream) abutment. A spillway width of 1,500 feet was selected to: a) safely pass the probable maximum flood (PMF); and b) provide materials for construction of the embankment dam. This spillway width results in the top of dam being approximately 140 feet above the low point in the river (estimated from USGS topography). The maximum flow depth through the spillway would be approximately 10 feet during the 100-year flood and 30 feet during the PMF.

Sufficient construction materials were assumed to be available within the immediate project vicinity to construct the recommended dam type. Earth and rock fill materials for the embankment dam would be secured from the spillway excavation, terrace deposits which likely exist along the river, and other required excavations for the dam foundation. Aggregates for concrete and filter/drain zones within the dam would be processed from alluvial terrace deposits or imported from off-site commercial sources. Suitable clay material for the core of the embankment dam may be in limited supply, but was assumed to be available from sources within reasonable haul distances from the site.

The recommended Lower Blanco project would require minimal road relocations. It was assumed that the two existing low-water crossings at the far upper end of the recharge pool would need to be replaced with highway bridges, each spanning 300 feet across the river to remain above the 50-year flood pool level (see Figure 2.2-1).

Although the Lower Blanco site is located near the downstream edge of the Edwards Aquifer recharge zone, flows may be stored in the reservoir for extended periods because of the limited natural infiltration rate. In order to more efficiently utilize the water stored in the reservoir for recharge, it was assumed that 1,048 acft per month would be diverted approximately 4.5 miles via a 24-inch diameter pipeline to the southeast to the upper San Marcos River watershed. Once released near the watershed divide, the diverted water would enter the dead pool storage of three existing SCS/FRS reservoirs located in the Edwards Aquifer recharge zone upstream of San Marcos (see Figure 2.2-2). The pipeline diversion rate of 1,048 acft per month was selected based on the assumption that the total dead pool storage of the three reservoirs (524 acft) would recharge twice per month.

Much of the data contained in Table 2.2-1 is also presented graphically in Figure 2.2-5. The recommended recharge pool capacity of 50,000 acft results in 49,766 acft/yr of recharge

RECHARGE ENHANCEMENT SUMMARY

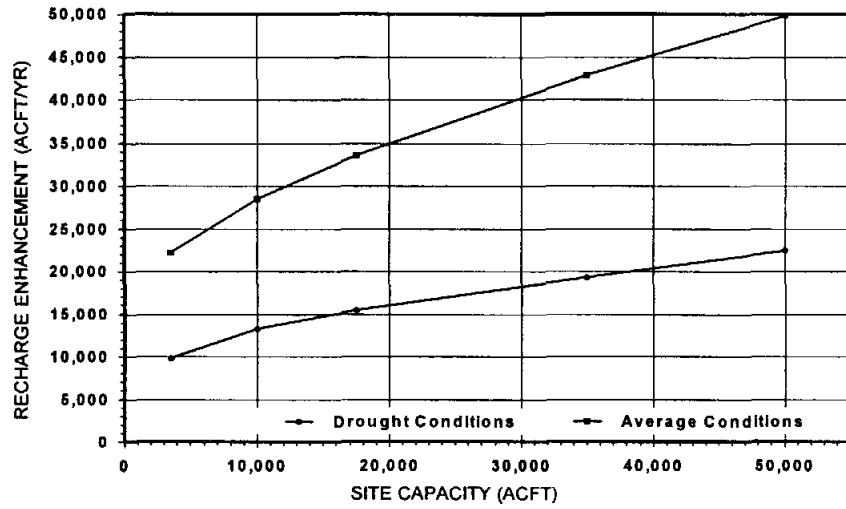

DOWNSTREAM IMPACT SUMMARY

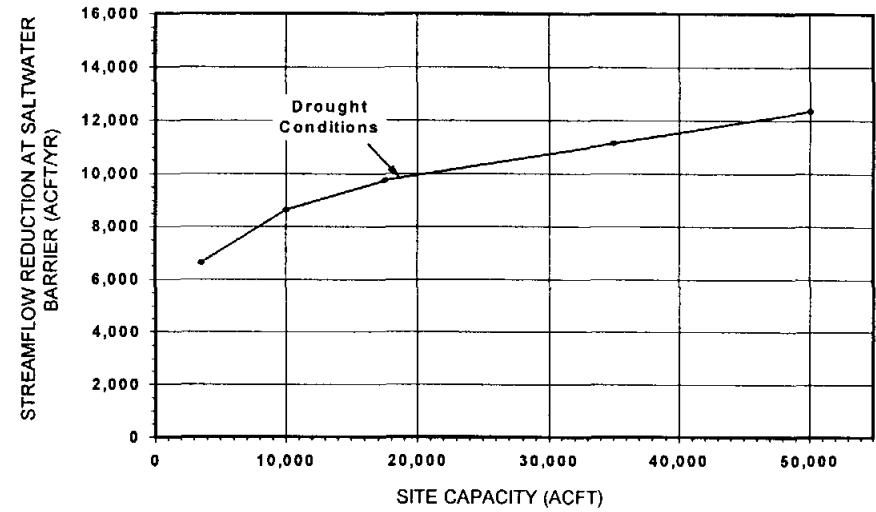

RECHARGE PROJECT COST SUMMARY

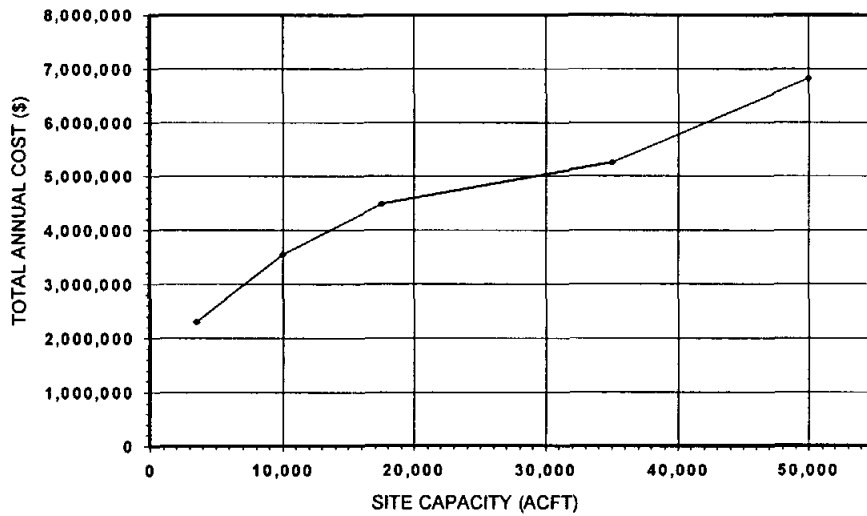

RECHARGE PROJECT OPTIMIZATION SUMMARY

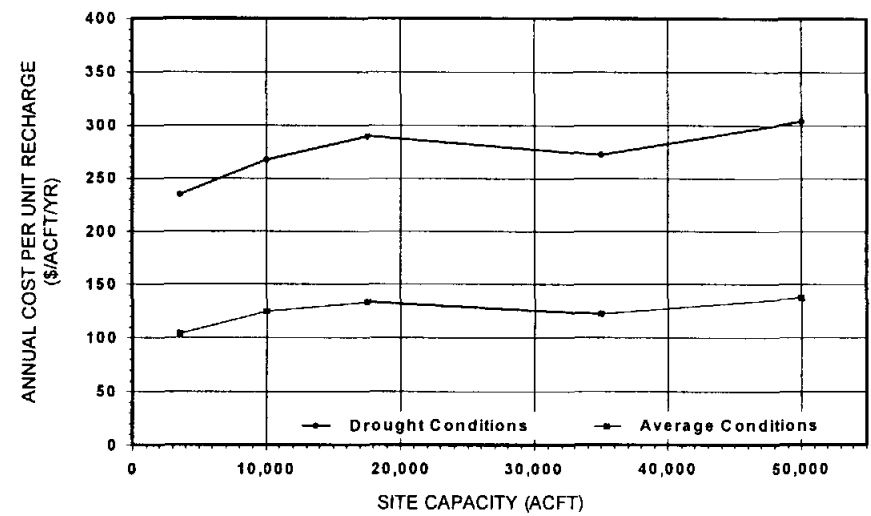

TRANS TEXAS WATER PROGRAM /  
WEST CENTRAL STUDY AREA

LOWER BLANCO PROJECT  
EVALUATION SUMMARY

FIGURE 2.2-5

enhancement under average conditions at a unit cost of \$137/acft/yr. Recharge under drought conditions would be increased by 22,490 acft/yr at a unit cost of \$304/acft/yr.

A graph illustrating the annual natural recharge and the recharge enhancement resulting from development of the recommended size Lower Blanco project is shown in Figure 2.2-6 for the 56-year period of record from 1934 through 1989.

Figure 2.2-7 shows the frequency of various storage levels for the recommended size project. It indicates that, for the historical period, the recharge pool would be empty less than 20 percent of the time. It also shows that approximately 15 percent of the time, the reservoir would be full. This graph helps to illustrate the tremendous potential this project has for recharging the Edwards Aquifer through the storage and diversion of water captured in the Blanco River basin.

The calculation of potential recharge enhancement and, therefore, the unit cost of enhancement is a function of the natural percolation rate used for the recharge pool in the model. Uncertainties exist regarding the natural percolation rate and subsequent movement of ground water at the Lower Blanco site. Work required to address these uncertainties is beyond the scope of this study. Further geologic and hydrogeologic investigations are recommended to obtain a better understanding of these issues and determine the most beneficial and cost effective means of developing this potentially significant water source.

## 2.2.6 Implementation Issues

### Requirements Specific to Surface Recharge Structures

1. It will be necessary to obtain these permits:
  - a. TNRCC Water Right and Storage Permit.
  - b. U.S. Army Corps of Engineers Sections 10 and 404 dredge and fill permits for the reservoir.
  - c. GLO Sand and Gravel Removal permits.
  - d. GLO Easement for use of state-owned lands.
  - e. Coastal Coordination Council review.
  - f. TPWD Sand, Gravel, and Marl permit.
2. Permitting, at a minimum, will require these studies:
  - a. Bay and estuary inflow impact.
  - b. Habitat mitigation plan.
  - c. Environmental studies.
  - d. Cultural resource studies.



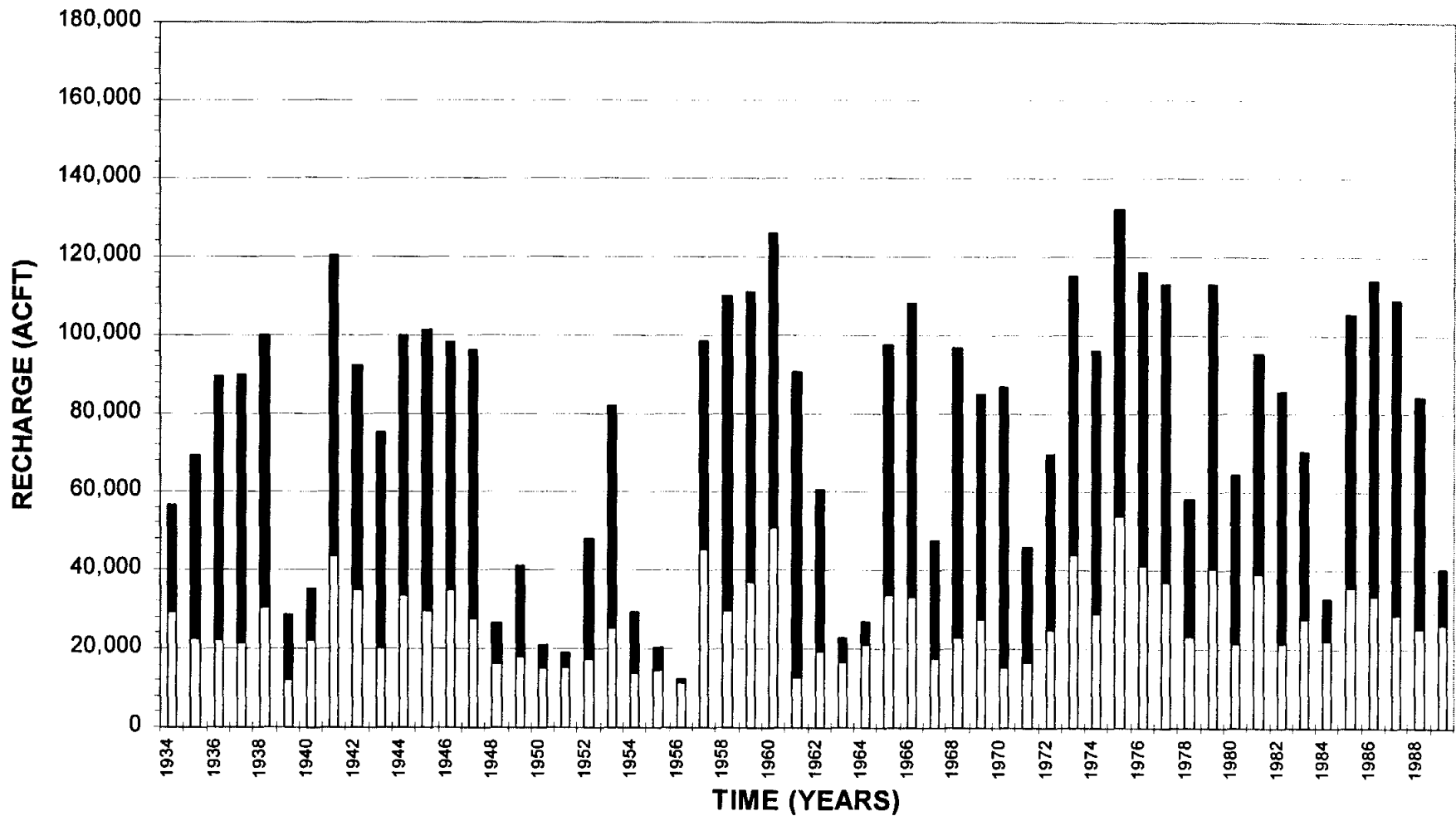

□ NATURAL RECHARGE

■ RECHARGE ENHANCEMENT

TRANS TEXAS WATER PROGRAM /  
WEST CENTRAL STUDY AREA

LOWER BLANCO PROJECT  
ANNUAL RECHARGE



HDR Engineering, Inc.

GUADALUPE - SAN ANTONIO RIVER BASIN  
RECHARGE ENHANCEMENT STUDY  
FEASIBILITY ASSESSMENT

FIGURE 2.2-6

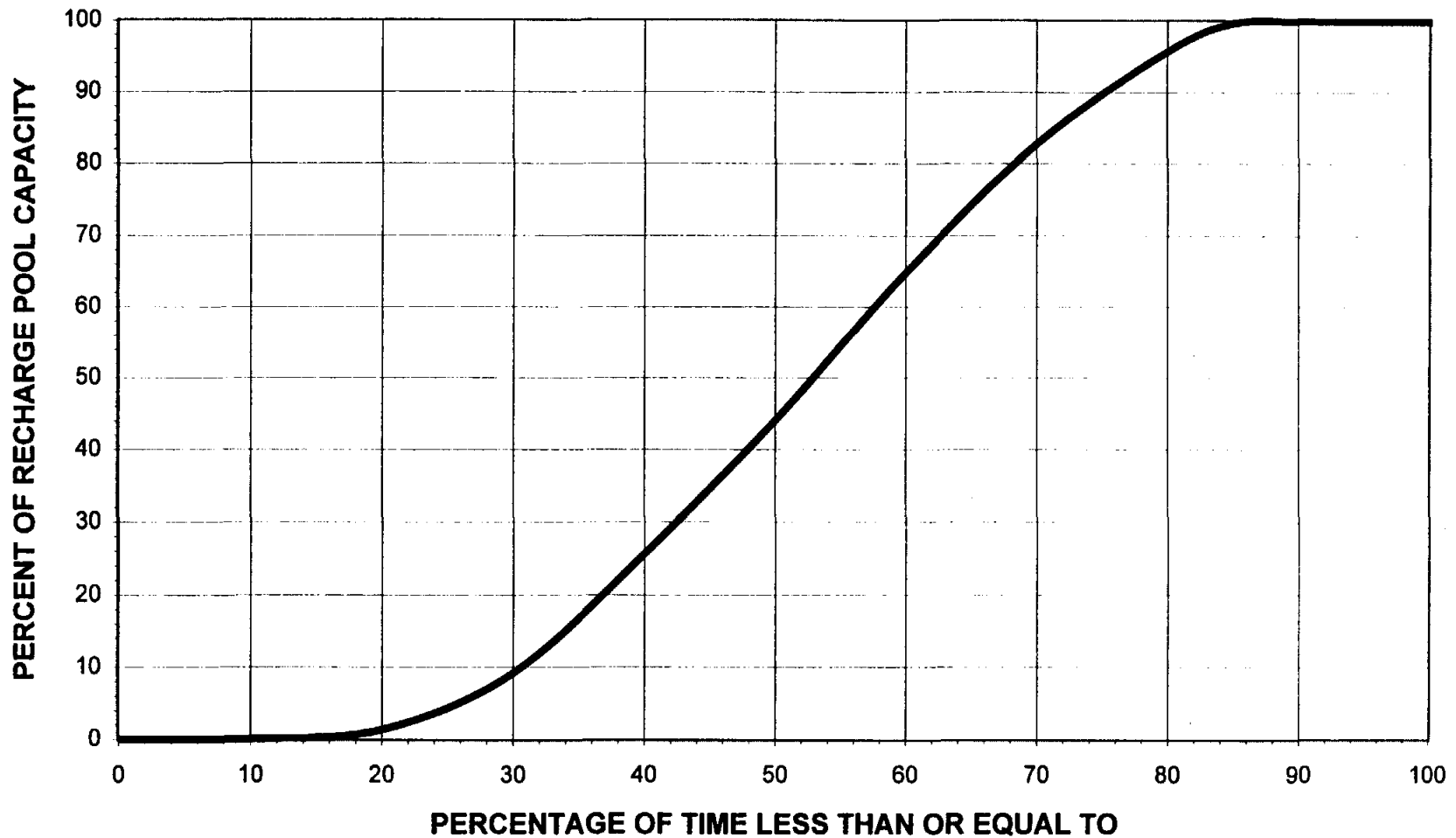

**RECHARGE POOL CAPACITY = 50,000 ACFT**

**TRANS TEXAS WATER PROGRAM /  
WEST CENTRAL STUDY AREA**

**LOWER BLANCO PROJECT  
STORAGE FREQUENCY**

*GUADALUPE - SAN ANTONIO RIVER BASIN  
RECHARGE ENHANCEMENT STUDY  
FEASIBILITY ASSESSMENT*



HDR Engineering, Inc.

**FIGURE 2.2-7**

- e. Study of impact on karst geology organisms from sustained recharge.
- f. Other environmental studies.
- 3. Land will need to be acquired through either negotiations or condemnation.
- 4. Detailed geologic and hydrogeologic investigations of the reservoir area to determine natural and expected recharge rates and the subsequent movement of ground water from the site.

Requirements Specific to Diversion Pipeline

- 1. Necessary permits:
  - a. U.S. Army Corps of Engineers Sections 10 and 404 dredge and fill permits for stream crossings.
  - b. GLO Sand and Gravel Removal permits.
  - c. Coastal Coordination Council review.
  - d. TPWD Sand, Gravel, and Marl permit.
- 2. Right-of-Way and easement acquisition:
- 3. Crossings:
  - a. Highways and railroads.
  - b. Creeks and rivers.
  - c. Other utilities.

## 2.3 Upper Blanco Project with Diversion to Upper San Marcos Watershed (L-21C)

### 2.3.1 Description of Alternative

The proposed Upper Blanco project is located just upstream of the Edwards Aquifer recharge zone on the Blanco River upstream of the Halifax Creek confluence. This project is the only Type 1 recharge project analyzed in this study. Type 1 projects are located upstream of the recharge zone and enhance recharge downstream by capturing the flood flow peaks and releasing water over an extended period of time, thereby increasing the percentage of flood water that is recharged. These structures are often referred to as “catch and release” projects and maintain a more constant pool level than the Type 2 direct recharge projects. The Upper Blanco project replaces the Cloptin Crossing project analyzed in previous recharge enhancement studies.<sup>26</sup> In addition to releasing flows to the Blanco River for recharge, this project also includes a pipeline that would divert water from the reservoir west to the upper San Marcos River watershed. Figures 2.3-1 and 2.3-2 show the approximate locations of the Upper Blanco project, existing upper San Marcos SCS/FRS sites, and diversion pipeline.

The Upper Blanco dam site is located approximately five miles west of Kyle in eastern Hays County. The proposed dam centerline is approximately 2,500 feet upstream of where Halifax Creek joins the Blanco River (see Figure 2.3-1). The elevation of the creek bed at the proposed dam site is approximately 668 ft-msl. The drainage area above the dam site is 392 square miles.

Geologic mapping shows the proposed dam site occupies the upper part of the lower member (Kainer Formation) of the Edwards limestone. The mapping also indicates that several potential faults may underlie the dam site. Several photo-lineaments have also been noted at the proposed site, indicating enhanced bedrock porosity and permeability in the vicinity of the dam. This and other sag-like depressions observed during the site reconnaissance may suggest possible dissolution along these possible fracture zones, which could pose structural problems with placement of the dam.<sup>27</sup> Although not considered to be a “fatal” flaw, it appears from the cursory

---

<sup>26</sup> HDR Engineering, Inc. (HDR), “Guadalupe - San Antonio River Basin Recharge Enhancement Study,” Vols. 1,2, and 3, Edwards Underground Water District, September, 1993.

<sup>27</sup> Fugro-McClelland (Southwest), Inc., “Geotechnical Consultation - Recharge Enhancement Study, Phase II Guadalupe - San Antonio River Basin,” December 23, 1997.

(This page intentionally left blank.)

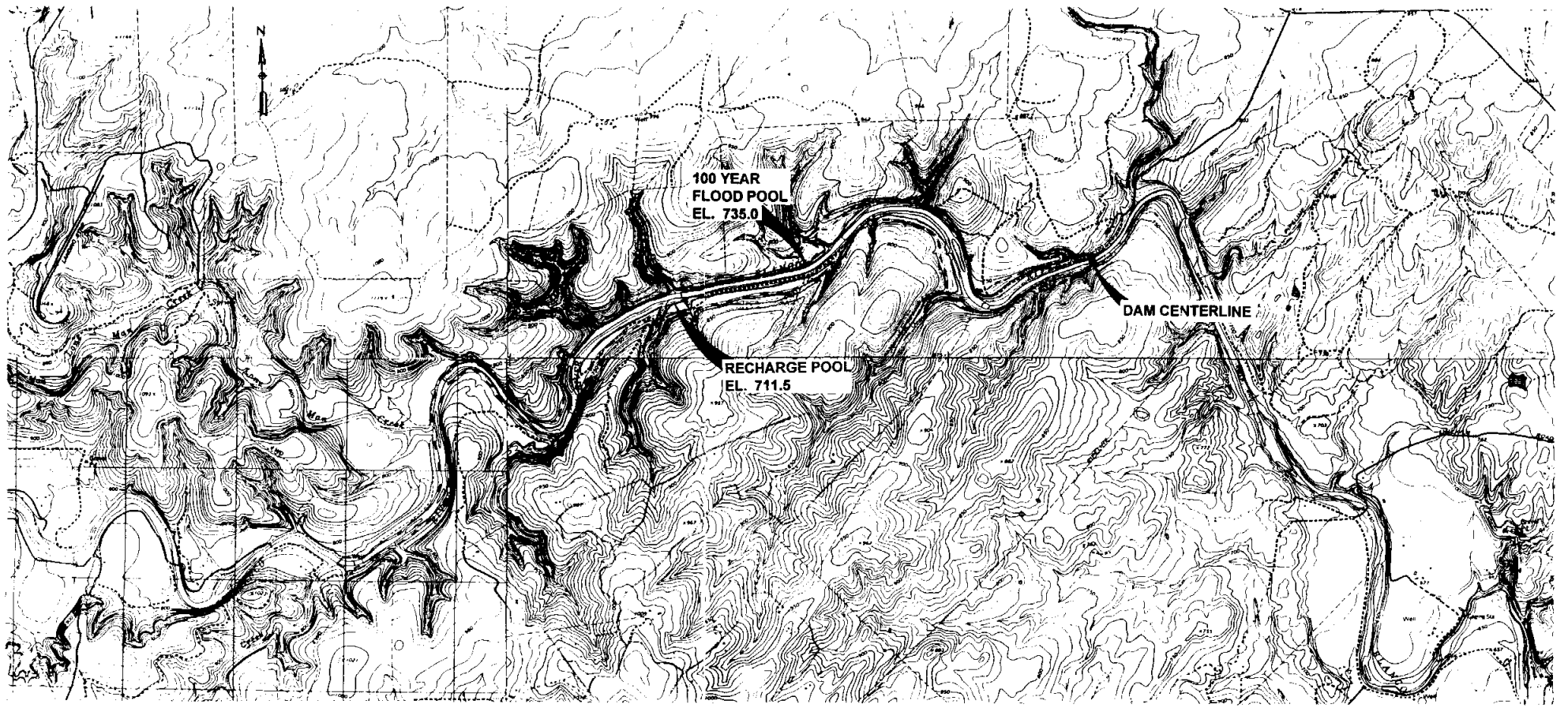

GUADALUPPE - SAN ANTONIO RIVER BASIN  
RECHARGE ENHANCEMENT STUDY  
FEASIBILITY ASSESSMENT

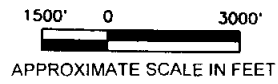

TRANS TEXAS WATER PROGRAM /  
WEST CENTRAL STUDY AREA



UPPER BLANCO PROJECT  
SITE MAP

HDR Engineering, Inc.

FIGURE 2.3-1

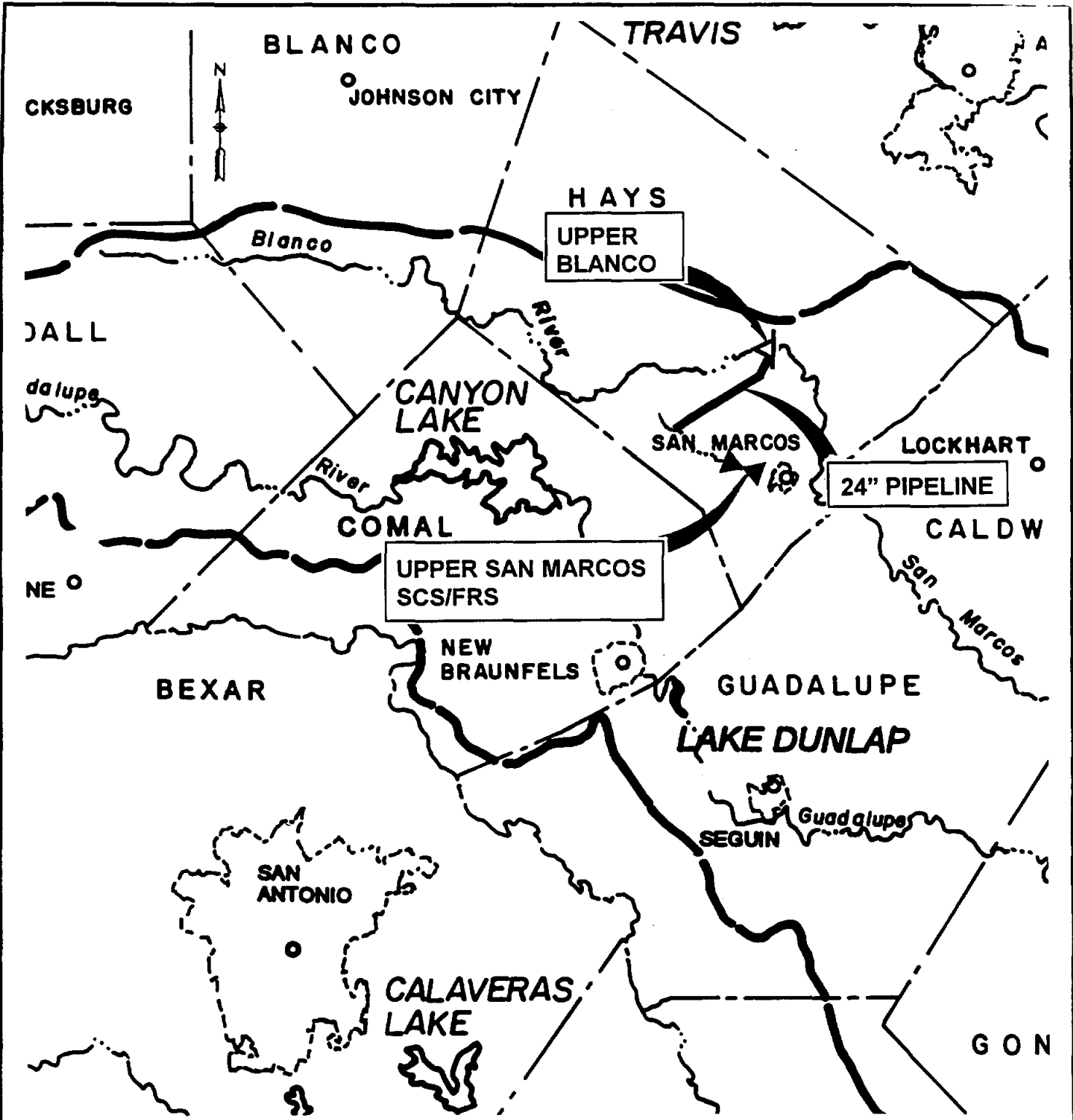

-  PROPOSED RECHARGE PROJECT
-  EXISTING SCS/FRS RESERVOIRS

GUADALUPE - SAN ANTONIO RIVER BASIN  
 RECHARGE ENHANCEMENT STUDY  
 FEASIBILITY ASSESSMENT



HDR Engineering, Inc.

TRANS TEXAS WATER PROGRAM /  
 WEST CENTRAL STUDY AREA

**UPPER BLANCO PROJECT  
 DIVERSION PIPELINE**

FIGURE 2.3-2

mapping efforts to date that foundation exploration, design, and construction considerations could be extensive for a dam at the proposed site.

### 2.3.2 Recharge Enhancement Hydrology

The Upper Blanco project recharge pool capacities analyzed in this study were operated on a daily timestep, honoring all downstream existing water rights, and assuming environmental flow requirements. Direct percolation recharge was not a component at this site because the project is located upstream of the Edwards Aquifer recharge zone. Total recharge included natural recharge downstream of the project, recharge from releases made from the reservoir downstream to the Blanco River, and recharge of water diverted to the upper San Marcos watershed. Details of the recharge reservoir operations and environmental flow requirements used are discussed in Appendix A.

Recharge pool capacities ranging from 3,000 to 30,000 acft were evaluated for the Upper Blanco project. Two pipeline sizes for diversions to the upper San Marcos watershed were analyzed, a 24-inch and a 36-inch diameter pipe. Long-term average recharge enhancement (1934-89) ranged from 9,755 acft/yr for the 3,000 acft project size to 11,177 acft/yr for the largest size (30,000 acft), assuming a 24-inch diversion pipeline to the upper San Marcos watershed. Drought average recharge enhancement (1947-56) with a 24-inch pipeline was found to range from 5,406 acft/yr to 11,043 acft/yr for the smallest and largest sizes, respectively. As with the Lower Blanco project, the 24-inch pipeline can deliver 1,048 acft per month to the upper San Marcos watershed operating at a steady, continuous rate, and the 36-inch pipeline offers some operational flexibility since it can deliver twice as much water in a month. Analyses in this study showed that when a maximum monthly diversion limitation of 1,048 acft per month is enforced, the additional average annual enhancement gained from a 36-inch (as compared to a 24-inch) pipeline is minimal. For the 30,000 acft capacity Upper Blanco project, the additional recharge enhancement gained by operating a 36-inch pipeline is only 10 acft per year (0.1 percent). As will be presented later in Section 3.0, the Upper Blanco project was not included in the recommended recharge enhancement program.



### 2.3.3 Environmental Issues

The Upper Blanco project is a proposed Type 1 (catch and release) impoundment on the Blanco River. The dam centerline would be located upstream of the residential compound on the Halifax Ranch in Hays County. The Blanco River and its tributaries in this reach are deeply incised into rocky canyons that dissect the rolling Edwards Plateau upland. The upland portions of this site are predominantly covered with live oak-Ashe juniper parks and woods, while pecan and bald cypress mark a narrow floodplain and riparian corridor. The surrounding area is primarily used for cattle ranching.

The Upper Blanco project is located on the Central Texas Plateau,<sup>28</sup> also known as the Edwards Plateau, just upstream of the Balcones Fault Zone and Blackland Prairie.<sup>29,30</sup> The Central Texas Plateau is a deeply dissected, rapidly drained, rocky plain with broad, flat divides (see Appendix B, Section 2.2 Habitats and Biogeography). The uplands are typically savannahs with invading brush species. The steep canyon slopes typically support oak-Ashe juniper thickets. The side canyons in this area are unique mesic habitats typically exhibiting numerous seeps and spring-fed rivulets and perennial pools which emerge from the base of the Edwards limestone.

The surface geology of the Upper Blanco site is Cretaceous Fredericksburg Group and Glen Rose Limestones.<sup>31</sup> The soil units that have formed over these limestones are predominantly thin soils from the Ekrant-Rock Outcrop Complex (steep), Comfort - Rock Outcrop Complex (undulating), Boerne Fine Sandy Loam (1 to 3 percent slopes), Rumble - Comfort association (undulating), Lewisville silty clay (1 to 3 percent slopes), and Seawillow Clay Loam (3 to 8 percent slopes).<sup>32</sup> The dominant soil unit found within the proposed recharge site is the Ekrant - Rock Outcrop complex.

Land uses, habitat types and wetland occurrences within the study area were identified and evaluated using available literature and a variety of other sources, including the Texas Natural

---

<sup>28</sup> Omernik, J.M. 1987. Ecoregions of the conterminous United States. *Annals of the Association of American Geographers* 77:11-125.

<sup>29</sup> Ibid.

<sup>30</sup> Gould, F.W. 1962. *The Grasses of Texas*. Texas A&M University Press. College Station, Texas.

<sup>31</sup> Fisher, W.L. 1974. *Geologic Atlas of Texas: Austin Sheet*. Bureau of Economic Geology. The University of Texas at Austin. Austin, Texas.

<sup>32</sup> Batte, C.D. 1984. *Soil Survey of Comal and Hays Counties, Texas*. United States Department of Agriculture Natural Resource Conservation Service.

Resources Information System's aerial photography and map database; Texas Highway Department aerial photography; Texas Parks and Wildlife Department (TPWD), Resource Protection Division's data and mapping files for endangered, protected and sensitive resources; Texas Organization for Endangered Species (TOES) listings of endangered, protected and sensitive resources; U.S. Fish and Wildlife Service (USFWS) National Wetland Inventory (NWI) maps; information available from the Edwards Aquifer Research and Data Center; USGS library resources; Texas Natural Resource Conservation Commission (TNRCC) publications and library; consultant reports; and the general biological literature, particularly descriptions of the habitat requirements of species listed as Endangered or Threatened by either the U.S. Department of the Interior or the State of Texas. This database, including archeological sites, significant environmental features, state natural areas, protected species and potential wetland areas is maintained at Paul Price Associates, Inc. on USGS 7.5 minute quadrangles.

The land located within the proposed project area is predominantly used for rangeland and wildlife habitat, although there are small areas that can be used for pasture and cropland.<sup>33</sup> Hays County ranked 196th in 1985 in agricultural receipts, of which 77 percent were derived from livestock and livestock products including beef cattle, sheep, wool, angora goats, and mohair.<sup>34</sup> About 8 percent of the agricultural land is used for harvested crops and less than 1 percent is irrigated. Primary crops include hay, sorghum, and corn for feed. Primary vegetables, fruits, and nuts include tomatoes and potatoes. In 1987, Hays County ranked 37th in the state in retail sales volume. The businesses and industries employing the most people included restaurants, manufacturing, contract construction, health services, and finance. Non-farm income in 1986 totaled \$6.7 million.

The left overbank terrace adjacent to the river is bottomland with bald cypress (*Taxodium distichum*), cottonwoods (*Populus deltoides*), and pecan (*Carya illinoensis*) trees providing overstory for the manicured lawn. Upslope from the river on the left bank, above the first overbank terrace, the canopy changes to mostly oaks (*Quercus* spp.) and cedar elm (*Ulmus crassifolia*). The right bank of the river was lined with cottonwoods, cypress, and pecan. Ashe juniper (*Juniperus ashei*), American elm (*U. americana*), live oaks (*Q. virginiana*), box elder

---

<sup>33</sup> Price, P. 1994. Field notes from a visit to the site. Paul Price Associates, Inc. Austin, Texas. August 1-2, 1994.

(*Acer negundo*) and hackberry (*Celtis laevigata*) dominate the vegetational community moving upslope. The area for the proposed project size examined contains 331.9 acres of woods, 283.3 acres of parks, 139.3 acres of brush and 40.2 acres of grassland (Appendix B, Table 4). Wetlands cover 140.3 acres of the project area. The wetlands are classified in order of predominance as temporarily flooded, palustrine habitat forested with broad-leafed deciduous trees, open water or diked lower perennial riverine habitat, temporarily flooded intermittent riverine habitat or streambed and seasonally flooded unconsolidated shore of lower perennial riverine habitat (Appendix B, Table 4). Personal observations revealed a river of approximately 55 to 100 feet wide with a substrate of exposed bedrock and gravel.<sup>35</sup> If inundated, these wetlands will likely need to be mitigated. Typically this is done through purchase and preservation of similar wetlands outside the project area.

Based on the location of the proposed project site, the endangered, threatened, or important species that might occur in the proposed project site could include Cagle's map turtle (*Gratemys caglei*), Black-capped vireo (*Vireo atricapillus*), Golden-cheeked warbler (*Dendroica chrysoparia*), various *Eurycea* species (*E. sp. 7*, *E. pterophila*), and in subterranean karst and springs, the Blanco blind salamander (*E. robusta*) which was found in the Blanco River only once during a gravel quarry operation (Appendix B, Tables 1 and 2). See Appendix B, Section 2.5 for discussions of the potential protected species of the area. TPWD data files show that the Guadalupe bass, a TOES Watch List species, is the only important species reported in or near the proposed Upper Blanco site (Appendix B, Table 5). Because of very limited site habitat information, an intensive survey of the project area would be required to accurately describe the habitats within the project area and determine the presence of any associated endangered, threatened or important species. The nature of the geology of the area also requires the characterization of karst features by a karst biologist to determine the presence or absence of any associated protected or endangered species (see Appendix B, Sections 2.2 and 2.3 for karst discussions).

A search of the database at the Texas Archeological Research Laboratory (TARL) revealed numerous archeological sites recorded within the general area of the proposed recharge

---

<sup>34</sup> Clements, J. 1988. Texas Facts: A Comprehensive Look at Texas Today County by County. Clements Research II, Inc. Dallas, Texas.

site, although none were within the proposed inundation area. A total of 15 archeological sites are located in the vicinity of the project area including: seven burned rock middens (three of the mid-late archaic period), one quarry, four archaic open camps, one nineteenth century homestead and two sites of unknown use and date. Prior to inundation, it must be determined if any cultural properties are located within the project area by an on-site survey. Once all cultural properties within the project area are identified, they will undergo preliminary assessment, during the survey, to determine the significance and potential for eligibility in the Register of Historic Places. Because the assessment methods used during the survey are limited in their ability to determine significance potential, some sites may need to be subjected to more extensive test-level investigations before their eligibility can be adequately determined. Once cultural resource properties are determined to be eligible, they must either enter mitigation through avoidance or undergo scientific data recovery.

In summary, the environmental concerns associated with this proposed recharge include evaluation of the oak-Ashe juniper woods and parks within the project area for utilization by protected species, evaluation of the impact of inundation of Guadalupe bass habitat on this TOES species of concern, evaluation of the historic significance of cultural resources sites, and evaluation of the possible impacts of changing streamflows and loss of shallow, lotic headwater habitat to the aquatic inhabitants of the perennial upper Blanco River (Appendix B, Table 6). Estimated environmental related costs for the Upper Blanco recharge project can be found in Appendix B, Table 7. These estimates are based on a normal recharge level of 766 ft-msl. Environmental report costs include baseline surveys, a comprehensive Environmental Assessment and support for necessary permitting.

#### 2.3.4 Water Quality and Treatability

[To be completed in subsequent phases of study.]

#### 2.3.5 Engineering and Costing

Recharge pool capacities ranging from 3,000 to 30,000 acre-feet (acft) were evaluated for the Upper Blanco project. Three of the four conceptual dam designs presented in Appendix A

---

<sup>35</sup> Price, P. 1994. Field notes from a visit to the site. Paul Price Associates, Inc. Austin, Texas. August 1-2, 1994.

were utilized for the range of capacities examined. Table 2.3-1 provides pertinent physical, hydrologic, and cost data for the five recharge pool capacities evaluated at the proposed Lower Blanco site. A recharge pool capacity of 3,000 acft impounded by a roller compacted concrete (RCC) channel dam was determined to be the optimum size for the site, based strictly on the minimum unit cost of recharge enhancement under average conditions. However, as will be presented later during the recharge enhancement program development in Section 3.0, the Upper Blanco project is not recommended for further consideration.

The RCC channel dam is the most cost effective dam/spillway type for the optimum size reservoir at the Upper Blanco site. The left abutment (looking in the downstream direction) is a near-vertical exposed rock bluff (Edwards limestone) with virtually no soil cover for a height of about 90 feet. The right abutment slopes steeply and consistently away from the river for a height of roughly 120 feet and appears to be coated with a thin to non-existent cover of residual soil over in-place rock. At the dam site, there is a terrace less than 100 feet wide extending to the left of the river channel. The terrace is capped with a surficial layer of clay and is presumed to be about 20 feet thick.

As shown in Figure 2.3-3, the dam centerline geometry is suited to an RCC channel dam. At the optimum dam crest elevation of 711.5 ft-msl, the dam crest length needed to span the canyon is less than about 400 feet. The RCC channel dam is approximately 44 feet high measured from the low point of the creek. The 100-year flood flow at the site would overtop the channel dam by about 23 feet.

Sufficient construction materials appear to be available within the immediate project vicinity to construct the RCC channel dam. Aggregates for producing RCC are likely to be present in the alluvium terraces observed upstream of the dam site in the reservoir area. Additionally, aggregates could be crushed from the abundant Edwards limestones in the vicinity of the project site.

**Table 2.3-1  
Upper Blanco Project (with 24" Diversion) Cost and Data Summary**

<b>Physical Data</b>				
Recharge Pool:				
Capacity (acft)	3,000	7,500	15,000	30,000
Surface Area (ac)	182	343	534	951
Elevation (ft-msl)	711.5	728.8	746.1	766.7
Spillway Elevation (ft-msl)	711.5	728.8	746.1	766.7
Spillway Width (ft)	388	452	538	800
25-Year Flood Pool <sup>1</sup> :				
Elevation (ft-msl)	730.0	745.4	760.4	778.2
Surface Area (ac)	355	524	809	1,202
50-Year Flood Pool <sup>1</sup> :				
Elevation (ft-msl)	732.5	747.6	762.2	779.8
100-Year Flood Pool <sup>1</sup> :				
Elevation (ft-msl)	735.0	749.9	764.1	781.5
Surface Area (ac)	405	593	892	1,308
Dam Type	RCC Channel	RCC Channel	RCC Channel	Composite
Top of Dam Elevation (ft-msl)	711.5	728.8	746.1	806.7
Streambed Elevation (ft-msl)	668.0	668.0	668.0	668.0
<b>Hydrologic Data</b>				
Recharge Enhancement (acft/yr):				
Drought Conditions	5,406	6,836	8,655	11,043
Average Conditions	9,755	10,277	10,770	11,177
Median Conditions	11,826	11,799	11,764	11,897
Drought Average Annual Streamflow Reduction at Saltwater Barrier	3,791	4,699	5,672	6,995
<b>Summary of Project Costs</b>				
Dam, Spillway, and Appurtenant Works	\$2,685,222	\$4,871,622	\$7,946,732	\$8,811,265
Pump Station and Pipeline	\$3,664,541	\$3,664,541	\$3,664,541	\$3,664,541
Road Relocations	\$0	\$0	\$0	\$860,000
Land Acquisition	\$3,937,742	\$5,675,242	\$8,540,242	\$11,627,742
Environmental Mitigation	\$1,222,591	\$2,160,149	\$3,272,408	\$5,700,742
Engineering, Legal, Financial, and Misc.	\$2,672,296	\$3,644,587	\$5,055,061	\$6,503,134
<b>Total Capital Cost</b>	<b>\$14,182,391</b>	<b>\$20,016,141</b>	<b>\$28,478,984</b>	<b>\$37,167,424</b>
Annual Capital Cost (25years @ 8% interest)	\$1,328,890	\$1,875,512	\$2,668,481	\$3,482,588
Operations and Maintenance (annual)	\$592,200	\$602,529	\$616,707	\$624,265
Downstream Impacts (annual)	\$11,385	\$14,745	\$19,038	\$23,868
<b>Total Annual Cost</b>	<b>\$1,932,475</b>	<b>\$2,492,786</b>	<b>\$3,304,226</b>	<b>\$4,130,721</b>
Annual Cost/Unit Recharge Enhancement:				
Drought Conditions (\$/acft/yr)	\$357	\$365	\$382	\$374
Average Conditions (\$/acft/yr)	\$198	\$242	\$307	\$369

<sup>1</sup>Flood pools based on reservoirs being full at beginning of flood.

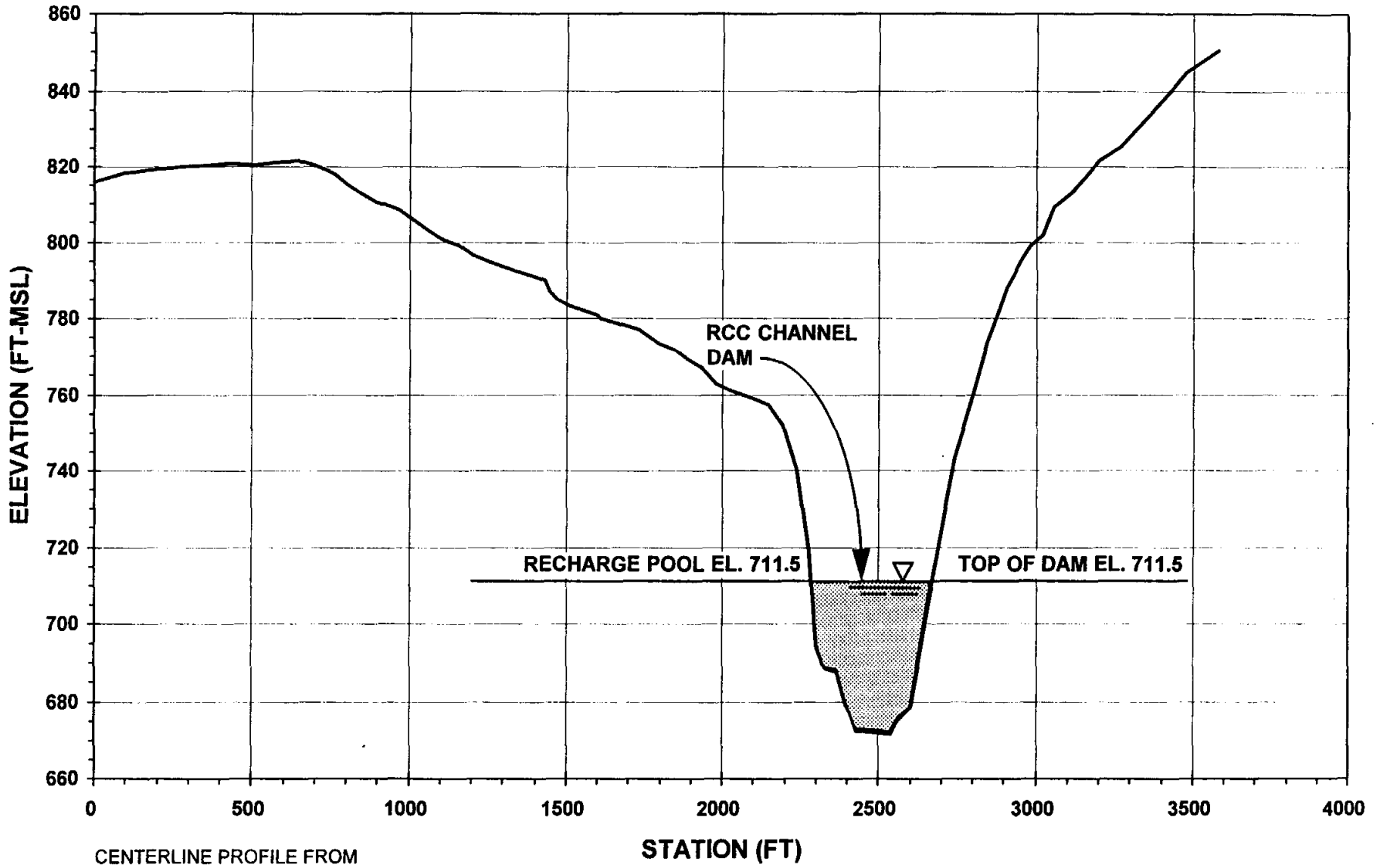

CENTERLINE PROFILE FROM  
 UNITED AERIAL MAPPING, 1994  
 PROFILE IS SHOWN LOOKING DOWNSTREAM

TRANS TEXAS WATER PROGRAM /  
 WEST CENTRAL STUDY AREA

UPPER BLANCO PROJECT  
 CENTERLINE PROFILE



HDR Engineering, Inc.

FIGURE 2.3-3

The optimum size recharge pool at the Upper Blanco site would not require any road relocations. Larger size storage capacities considered at this site would have significant impact on roads and development upstream along the Blanco River.

In order to more efficiently utilize the water stored in the reservoir for recharge, it was assumed that 1,048 acft per month would be diverted approximately 4.7 miles via a 24-inch diameter pipeline to the southeast to the upper San Marcos River watershed. Once released near the watershed divide, the diverted water would enter the dead pool storage of three existing SCS/FRS reservoirs located in the Edwards Aquifer recharge zone upstream of San Marcos (see Figure 2.3-3). The pipeline diversion rate of 1,048 acft per month was selected based on the assumption that the total dead pool storage of the three reservoirs (524 acft) would recharge twice per month.

Much of the data contained in Table 2.3-1 is also presented graphically in Figure 2.3-4. The optimum reservoir capacity of 3,000 acft results in 9,755 acft/yr of recharge enhancement under average conditions at a unit cost of \$198/acft/yr. Recharge under drought conditions would be increased by 5,406 acft/yr at a unit cost of \$357/acft/yr. These unit costs are higher than those computed for every recharge pool capacity evaluated at the proposed Lower Blanco project site.

### 2.3.6 Implementation Issues

#### Requirements Specific to Surface Recharge Structures

1. It will be necessary to obtain these permits:
  - a. TNRCC Water Right and Storage Permit.
  - b. U.S. Army Corps of Engineers Sections 10 and 404 dredge and fill permits for the reservoir.
  - c. GLO Sand and Gravel Removal permits.
  - d. GLO Easement for use of state-owned lands.
  - e. Coastal Coordination Council review.
  - f. TPWD Sand, Gravel, and Marl permit.
2. Permitting, at a minimum, will require these studies:
  - a. Bay and estuary inflow impact.
  - b. Habitat mitigation plan.
  - c. Environmental studies.
  - d. Cultural resource studies.



- e. Study of impact on karst geology organisms from sustained recharge.
- f. Other environmental studies.
- 3. Land will need to be acquired through either negotiations or condemnation.
- 4. Detailed field investigation of the dam foundation and abutments to study faulting and possible dissolution of fracture zones beneath the dam.

Requirements Specific to Diversion Pipeline

- 1. Necessary permits:
  - a. U.S. Army Corps of Engineers Sections 10 and 404 dredge and fill permits for stream crossings.
  - b. GLO Sand and Gravel Removal permits.
  - c. Coastal Coordination Council review.
  - d. TPWD Sand, Gravel, and Marl permit.
- 2. Right-of-Way and easement acquisition:
- 3. Crossings:
  - a. Highways and railroads.
  - b. Creeks and rivers.
  - c. Other utilities.

RECHARGE ENHANCEMENT SUMMARY

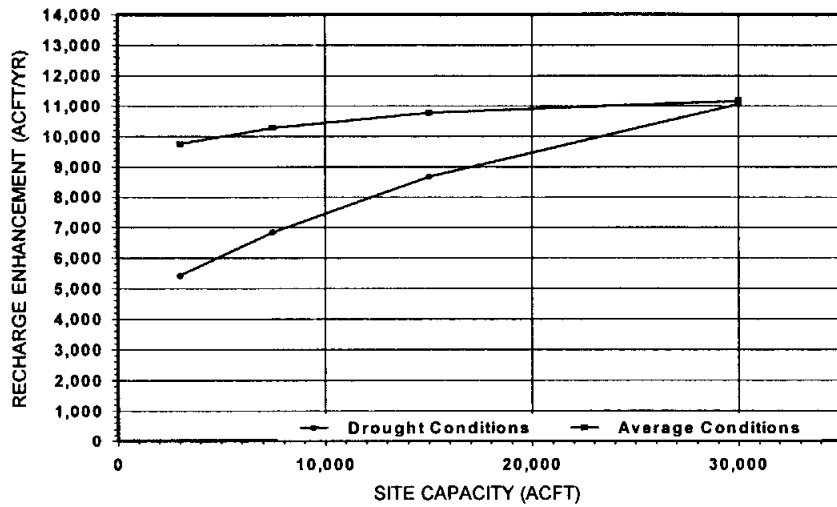

DOWNSTREAM IMPACT SUMMARY

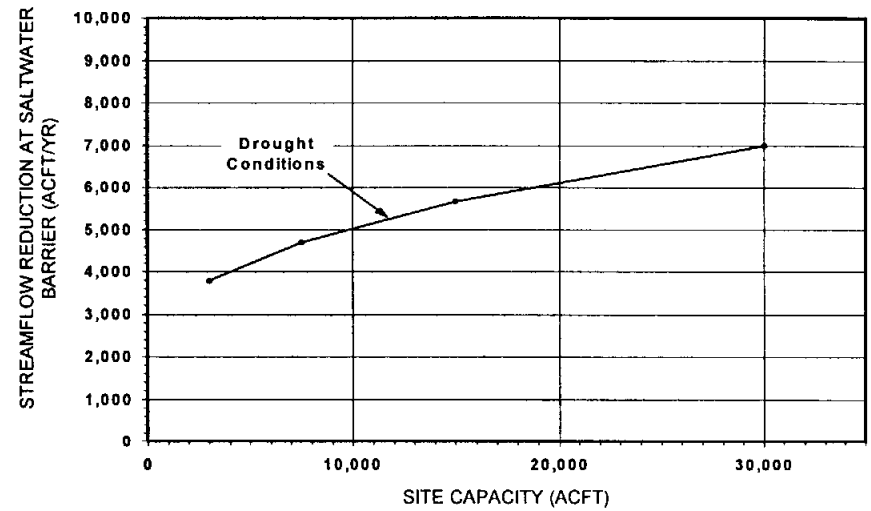

RECHARGE PROJECT COST SUMMARY

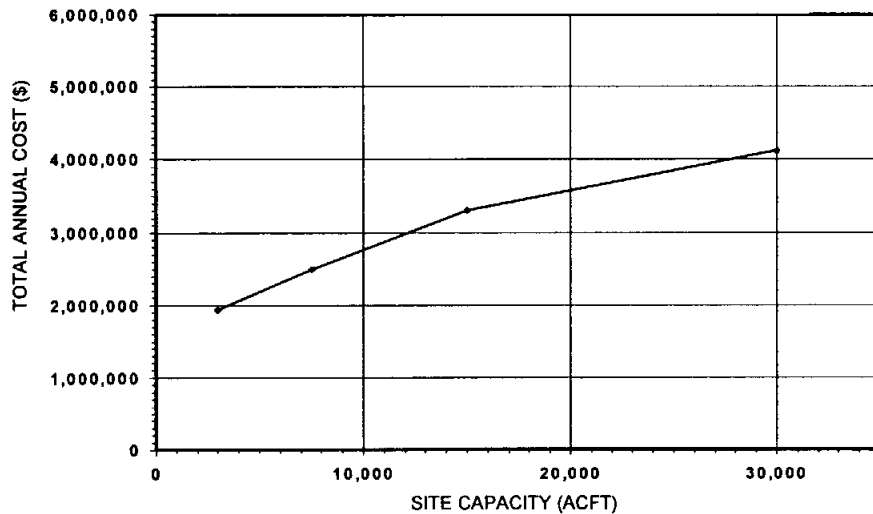

RECHARGE PROJECT OPTIMIZATION SUMMARY

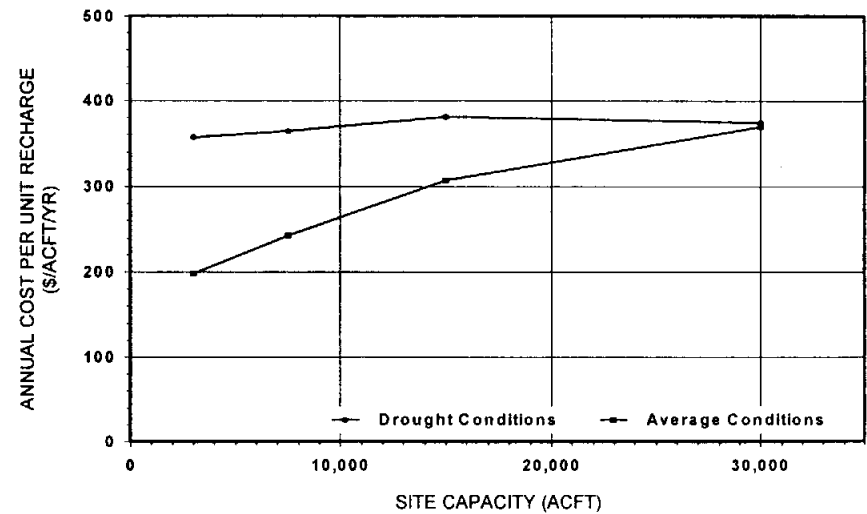

TRANS TEXAS WATER PROGRAM /  
WEST CENTRAL STUDY AREA

UPPER BLANCO PROJECT  
EVALUATION SUMMARY

FIGURE 2.3-4

## 2.4 San Geronimo Creek (L-21D)

### 2.4.1 Description of Alternative

The San Geronimo Creek project is located on San Geronimo Creek just upstream of the existing recharge project owned and operated by the Edwards Aquifer Authority (EAA). This project is a Type 2 (direct recharge) project and was chosen to take greater advantage of the relatively large watershed above the small existing San Geronimo Dam. Operation of the proposed structure would include releasing sufficient quantities of water in order to take advantage of the recharge potential of the existing structure as well. The approximate location of the proposed new recharge project is shown in Figure 2.4-1.

The San Geronimo Creek dam site is located within the Edwards Aquifer recharge zone approximately six miles east of Medina Lake in eastern Medina County. The proposed dam centerline crosses the creek in a north-south direction approximately 1,000 feet upstream of a new bridge for State Highway FM 211. The existing EAA recharge structure is located approximately one creek mile downstream of the proposed site. Because of a hairpin turn in the creek, the existing dam is about 2,000 feet southeast of the proposed dam. The elevation of the creek bed at the proposed dam centerline is 1,030 ft-msl. The drainage area above the dam site is 53 square miles.

The proposed dam site is located on the basal nodular member of the Edwards. This member corresponds to the Walnut Formation elsewhere in Central Texas, and it suggests that the dam site is located at or near the bottom of the Edwards section. This member consists of burrowed, fossiliferous, nodular limestone that shows considerable cavitation along the right (looking downstream) abutment. Several shallow caverns exist in the right abutment, with ceilings as much as 10 to 12 feet high and extending as deep as 15 to 20 feet into the bluff. A few smaller tunnels ranging from several inches to almost two feet in diameter extend an unknown distance into the bluff from the backside of the caverns. Three of the caverns explored contain natural bridges. The cavern development is partly due to past lateral undercutting of the outcropping limestone by the creek, and also by associated karst processes. However, there appears to be another, unknown process in which ablation of the rock surface is occurring in a

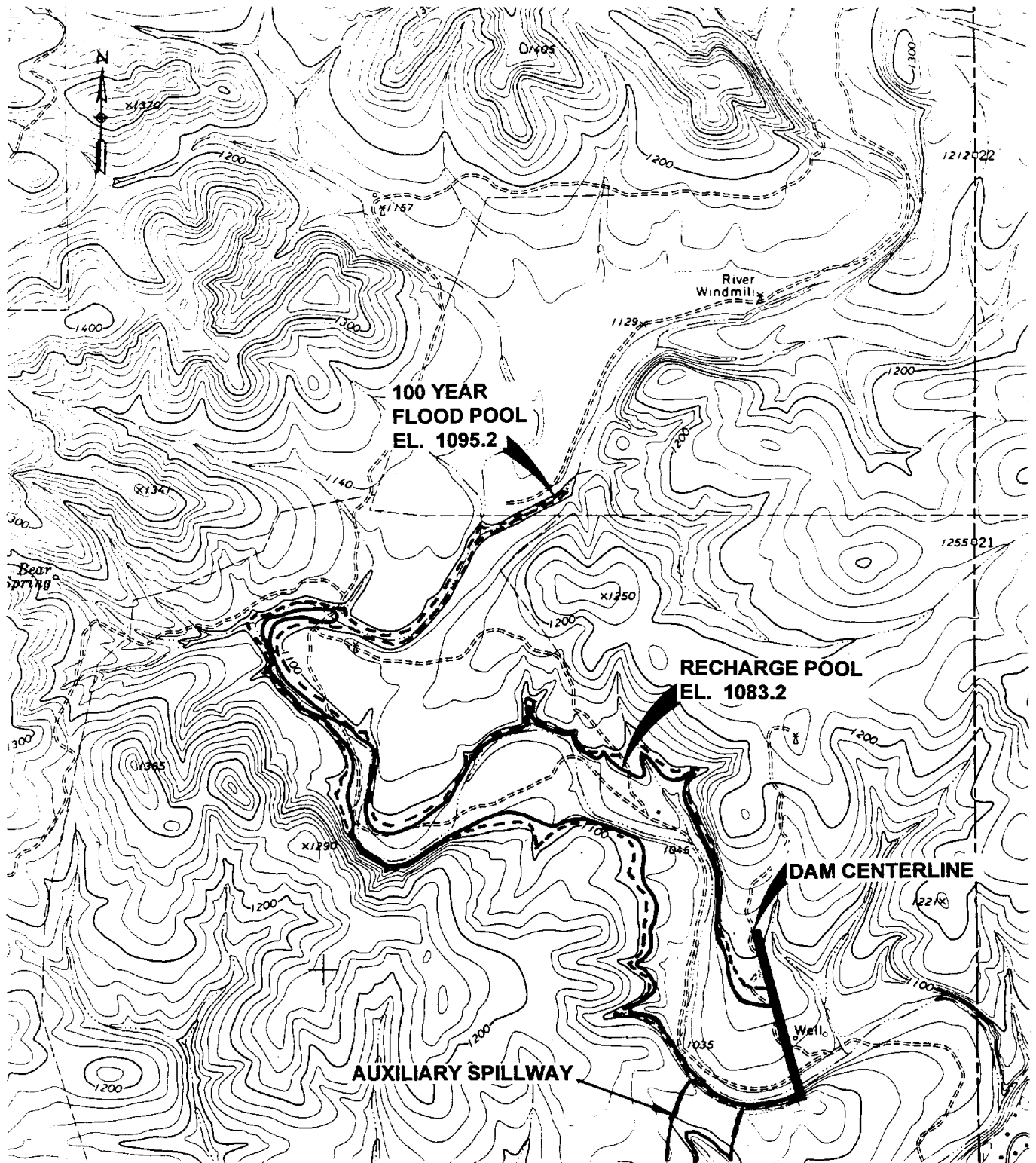

APPROXIMATE SCALE IN FEET

1000' 0 2000'



GUADALUPE - SAN ANTONIO RIVER BASIN  
RECHARGE ENHANCEMENT STUDY  
FEASIBILITY ASSESSMENT



HDR Engineering, Inc.

TRANS TEXAS WATER PROGRAM /  
WEST CENTRAL STUDY AREA

**SAN GERONIMO CREEK PROJECT  
SITE MAP**

FIGURE 2.4-1

dry state.<sup>36</sup> Engineering design of the dam abutments will need to address this unknown process and the apparent surficial weakness of these materials.

Another geologic feature of the site that will require further significant study is the topographic ridge that forms the right abutment. This ridge is very narrow because the creek makes a hairpin turn to the right (south) about 2,500 feet downstream of the proposed dam site. One of the main faults that marks the coastward edge of the exposed Cretaceous sediments along the Balcones Escarpment is located about 1,800 feet south-southeast of the dam, on the opposite side of the narrow ridge that forms the right abutment of the dam. With a recharge pool impounded by the proposed dam, significant hydraulic gradients will exist through this narrow ridge between the pool and the creek and an unnamed tributary on the south side of the ridge (see Figure 2.4-1). The potential for leakage through the ridge into the creek downstream of both the recharge zone and the existing recharge dam will need to be considered in future studies of this site.<sup>37</sup>

#### 2.4.2 Recharge Enhancement Hydrology

The San Geronimo Creek project recharge pool capacities analyzed in this study were operated on a daily timestep, honoring all downstream existing water rights, and assuming environmental flow requirements. In modeling this structure, all inflows to the new reservoir were passed until the old San Geronimo recharge reservoir was full. A unique recharge rate curve was developed for the new site (see Figure A.2-4 in Appendix A) and recharge at the site included natural recharge upstream and downstream of the project (including recharge in the existing old San Geronimo project) and direct percolation in the new recharge pool. Details of the recharge reservoir operations, development of the recharge rate curves, and environmental flow requirements used are discussed in Appendix A.

Recharge pool capacities ranging from 350 to 14,000 acft were evaluated for the San Geronimo Creek project. Long-term average recharge enhancement (1934-89) ranged from 2,375 acft/yr for the 350 acft project size to 3,231 acft/yr for the largest size (14,000 acft).

---

<sup>36</sup> Fugro-McClelland (Southwest), Inc., "Geotechnical Consultation - Recharge Enhancement Study, Phase II Guadalupe - San Antonio River Basin," December 23, 1997.

<sup>37</sup> Fugro-McClelland (Southwest), Inc., Op. Cit., 1997.

Drought average recharge enhancement (1947-56) was found to be considerably less, ranging from 528 acft/yr to 661 acft/yr for the smallest and largest sizes, respectively. The 3,500 acft capacity San Geronimo Creek project was included in the recommended program of recharge enhancement projects (see Section 3.0). The long-term and drought average annual recharge enhancements for this size project were found to be 3,128 acft/yr and 645 acft/yr, respectively. Analysis of the recharge pool capacities for the San Geronimo project with and without environmental flow passage criteria were the same, since the computed flow statistics for this location indicate no flow release requirements (i.e. mean and median streamflows are zero).

### 2.4.3 Environmental Issues

The San Geronimo Creek project is a proposed Type 2 (direct recharge) impoundment on San Geronimo Creek in Medina County, immediately upstream of an existing recharge project, near the county line with Bexar County to the east. The site is located about five miles west from Helotes, a suburb of San Antonio, where the land is predominantly oak-Ashe juniper wood and is used primarily for cattle ranching.

Medina County ranked 64th in 1985 in state agricultural receipts, of which 58 percent were in livestock and livestock products.<sup>38</sup> In 1985, about 83 percent of the total 852 thousand acres of land were in farms or ranches. About 16 percent of the agricultural land were in harvested cropland and 6 percent was irrigated. The primary livestock and products are beef and dairy cattle, sheep, wool, angora goats, and mohair. The primary crops are feed sorghum and corn, and wheat. Fruits and vegetables, including peaches, pecans, carrots, potatoes, and cabbages are locally important. Tourism travel expenditures in 1986 generated about 122 jobs and \$1.7 million in payroll.

The proposed San Geronimo Creek site is located in the Balcones Fault Zone, on the Balcones Escarpment, upstream of the South Texas Plains.<sup>39,40</sup> The Balcones Escarpment forms the southern and eastern boundary of the uplifted Edwards Plateau. It is characterized by a complex of porous, faulted limestones in streambeds, sinkholes, and fractures which allow

---

<sup>38</sup> Clements, J. 1988. Texas Facts: A Comprehensive Look at Texas Today County by County. Clements Research II, Inc. Dallas, Texas.

<sup>39</sup> Omernik, J.M. 1987. Ecoregions of the conterminous United States. *Annals of the Association of American Geographers* 77:11-125.

<sup>40</sup> Gould, F.W. 1962. *The grasses of Texas*. Texas A&M University Press. College Station, Texas.

substantial volumes of water to flow into the Edwards Aquifer (see Appendix B, Section 2.2 Habitats and Biogeography). The Balcones Fault is a transitional zone between the Edwards Plateau and the South Texas Plains and forms unique habitats favorable to a number of rare and protected species. The common isolated springs and caves favor endemism, where organisms become narrowly adapted to the stable, local environment.

The surface geology of the San Geronimo Creek site is Cretaceous Edwards and Glen Rose limestone.<sup>41</sup> The soil units that have been deposited in the streambed and floodplain are from the Tarrant – Rock Outcrop Association (hilly), Tarrant – Outcrop Association (undulating), Speck Association (undulating), and Orif Complex.<sup>42</sup>

Land uses, habitat types, and wetland occurrences within the study area were identified and evaluated using available literature and a variety of other sources, including the Texas Natural Resources Information System's aerial photography and map database; Texas Highway Department aerial photography; Texas Parks and Wildlife Department (TPWD), Resource Protection Division's data and mapping files for endangered, protected and sensitive resources; Texas Organization for Endangered Species (TOES) listings of endangered, protected and sensitive resources; U.S. Fish and Wildlife Service (USFWS) National Wetland Inventory (NWI) maps; information available from the Edwards Aquifer Research and Data Center; USGS library resources; Texas Natural Resource Conservation Commission (TNRCC) publications and library; consultant reports; and the general biological literature, particularly descriptions of the habitat requirements of species listed as Endangered or Threatened by either the U.S. Department of the Interior or the State of Texas. This database, including archeological sites, significant environmental features, state natural areas, protected species and potential wetland areas is maintained at Paul Price Associates, Inc. on USGS 7.5 minute quadrangles.

Although the vegetation of the area has been characterized oak - juniper woods, the land located within the proposed project area was observed to be predominantly an oak – Ashe juniper - Mesquite park.<sup>43</sup> The left bank of the creek apparently was cleared of the oak-juniper woods in

---

<sup>41</sup> Fisher, W.L. 1983. Geologic Atlas of Texas: San Antonio Sheet. Bureau of Economic Geology. The University of Texas at Austin. Austin, Texas.

<sup>42</sup> Dittmar, G.W., M.L. Dieke, and D.L. Richmond. 1977. Soil Survey of Medina County, Texas. United States Department of Agriculture Natural Resource Conservation Service.

<sup>43</sup> Price, P. 1994. Field notes from a visit to the site. Paul Price Associates, Inc. Austin, Texas. August 1-2, 1994.

the past, leaving only large oak trees. Substantial brushy re-growth has occurred and was dominated by Mesquite. The brushy growth, for the most part, was relatively tall and provided very little closed canopy cover. The habitat of the right bank of the creek consisted of a large cliff with shallow caves running parallel to the creek channel. Driftwood was found within these shallow caves indicating that they are periodically inundated. San Geronimo Creek within this reach is identified as an intermittent riverine habitat that is temporarily flooded. Habitats within the area of the proposed project size examined include about 14.5 acres of woods, 83.8 acres of park, 53.3 acres of brush, and 31.5 acres of wetland area (Appendix B, Table 4).

Based on the location of the proposed project site, the endangered, threatened, or important species that could occur include the Frio Pocket Gopher (*Geomys texensis bakeri*), Black-capped vireo (*Vireo atricapillus*), Golden-cheeked warbler (*Dendroica chrysoparia*), Texas indigo snake (*Drymarchon corais erebennus*), Texas Tortoise (*Gopherus berlandieri*), Texas horned lizard (*Phrynosoma cornutum*), Edwards Plateau spring salamander (*Eurycea* sp. 7), and the Valdina Farms sinkhole salamander (*E. troglodytes*) (Appendix B, Tables 1 and 2). See Appendix B, Section 2.5 for discussions of the potential protected species of the area. Although the TPWD data files show no confirmed reports of any endangered, threatened, or important species within the vicinity of the proposed recharge project, the information is based on a limited amount of survey data and an intensive survey of the project area would be required to accurately describe the habitats within the project area and determine the possibility of any associated threatened or endangered species. Also, the nature of the geology of the area requires the characterization of karst features by a karst biologist to determine the presence or absence of any associated protected or endangered species (see Appendix B, Sections 2.2 and 2.3 for karst discussions).

Modeling flows on San Geronimo Creek indicated that the 3,500 acft recharge project would decrease the annual average flows from 4,284 acft/yr without implementation to 1,156 acft/yr with implementation of the project. Figure 2.4-2 shows monthly median flows with and without the project. Analysis indicates that monthly medians without the project ranged from zero (in all months but May and June) to 51 acft in June and 130 acft in May. With project implementation, medians will decrease to 52 acft in May and 24 acft in June (with all other months remaining zero). Zero monthly medians indicate that flows through this area of San



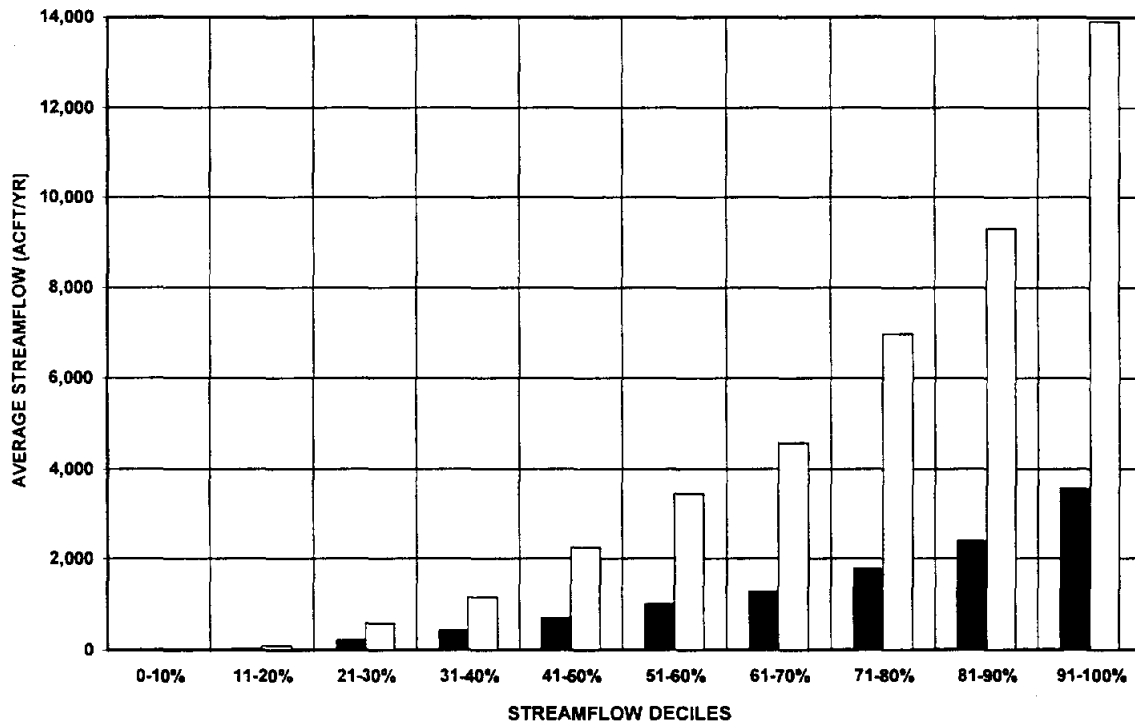
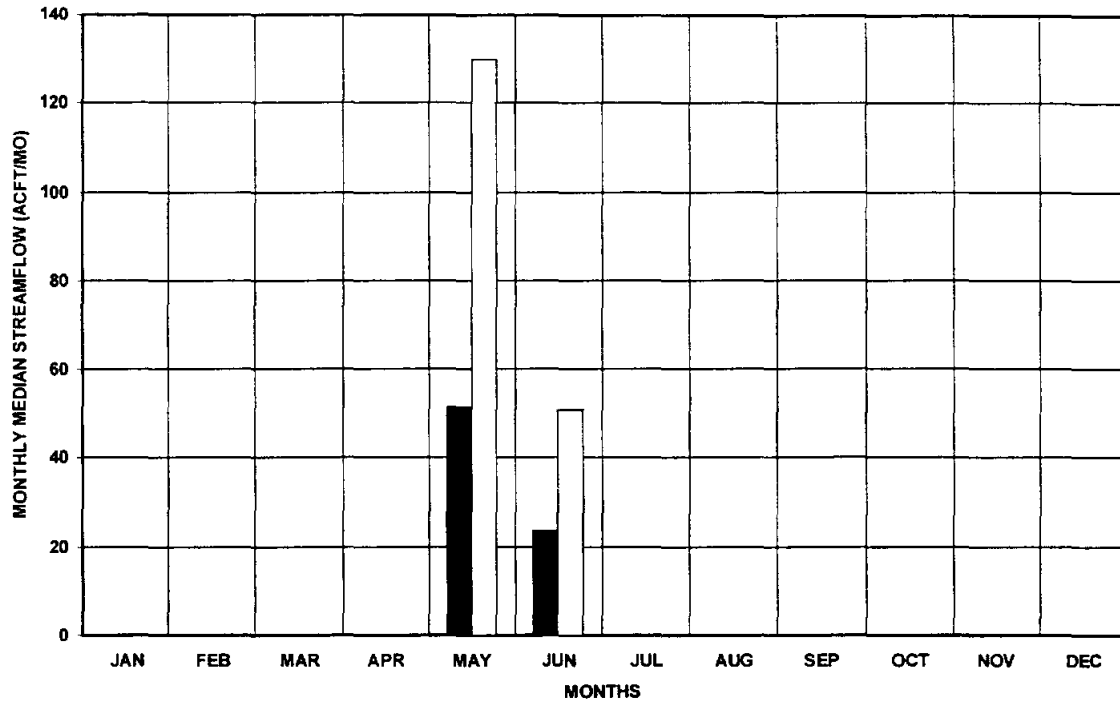

■ WITH PROJECTS    □ WITHOUT PROJECTS

NOTE: STATISTICS BASED ON  
1934-89 HISTORICAL PERIOD

GUADALUPE - SAN ANTONIO RIVER BASIN  
RECHARGE ENHANCEMENT STUDY  
FEASIBILITY ASSESSMENT



HDR Engineering, Inc.

TRANS TEXAS WATER PROGRAM /  
WEST CENTRAL STUDY AREA  
**SAN GERONIMO CREEK PROJECT**  
**CHANGES IN STREAMFLOW**  
SAN GERONIMO CREEK AT DOWNSTREAM  
EDGE OF EDWARDS OUTCROP  
FIGURE 2.4-2

Geronimo Creek come in short, intense spate periods. The modeled reductions in flow for San Geronimo Creek may have some effect upon the biological communities downstream, but it is not expected to be significant due to the already intermittent nature of the creek downstream of the recharge project.

A search of the database at the Texas Archeological Research Laboratory (TARL) revealed only a few archeological sites recorded from within the general area of the proposed recharge project. Prior to inundation, it must be determined if any cultural properties are located within the project area by an on-site survey. Once all cultural properties within the project area are identified, they will undergo preliminary assessment, during the survey, to determine the significance and potential for eligibility in the Register of Historic Places. Because the assessment methods used during the survey are limited in their ability to determine significance potential, some sites may need to be subjected to more extensive test-level investigations before their eligibility can be adequately determined. Once cultural resource properties are determined to be eligible, they must either enter mitigation through avoidance or undergo scientific data recovery (see Appendix B, Section 2.7).

In summary, the environmental concerns associated with this proposed recharge project include the evaluation of oak - Ashe juniper woods and oak - Ashe juniper - mesquite parks within the project area for utilization by protected species, evaluation of the impact of inundation on important habitats, karst surveys, and the evaluation of the historic significance of cultural resources sites, (Appendix B, Table 6). Estimated environmental related costs for the San Geronimo Creek recharge project can be found in Appendix B, Table 7. These estimates are based on a recharge pool level of 1,083 ft-msl. Environmental report costs include baseline surveys, a comprehensive Environmental Assessment, and permit support.

#### 2.4.4 Water Quality and Treatability

[To be completed in subsequent phases of study.]

#### 2.4.5 Engineering and Costing

Recharge pool capacities ranging from 350 to 14,000 acre-feet (acft) were evaluated for the San Geronimo Creek project. Given the favorable site topography for a side-channel spillway and availability of materials, only two of the conceptual dam designs presented in

Appendix A were appropriate for the range of capacities examined. A roller compacted concrete (RCC) channel dam was utilized for the smallest capacity, while an embankment dam with side-channel spillway was utilized for all other capacities evaluated. Table 2.4-1 provides pertinent physical, hydrologic, and cost data for the five recharge pool capacities evaluated at the proposed San Geronimo Creek site. A recharge pool capacity of 350 acft impounded by the RCC channel dam was determined to be the optimum size for the site, based strictly on the minimum unit cost of recharge enhancement under average conditions. As will be presented later during the recharge enhancement program development in Section 3.0, the recommended project size for the San Geronimo Creek site is the 3,500 acft capacity.

The embankment dam and side channel auxiliary spillway is the most cost effective dam and spillway configuration for the recommended size project at the San Geronimo Creek site. As shown in Figure 2.4-3, the dam centerline geometry is suited to an embankment dam with a side-channel spillway excavated in the topographic saddle along the right abutment ridge. A spillway width of 850 feet was selected to provide sufficient materials for the embankment dam and to safely pass the probable maximum flood (PMF). This spillway width results in the top of dam being approximately 79 feet above the low point in the creek. The maximum flow depth through the spillway would be approximately 7 feet during the 100-year flood and 20 feet during the PMF.

Sufficient construction materials are available within the immediate project vicinity to construct the recommended dam type. Earth and rock fill materials for the embankment dam would be secured from the spillway excavation, terrace deposits which exist in the recharge pool area, and other required excavations for the dam foundation. Aggregates for concrete and filter/drain zones within the dam would be processed from alluvial terrace deposits or imported from off-site commercial sources. Suitable clay material for the core of the embankment dam may be in limited supply, but is likely to be available from sources within reasonable haul distances from the site if the quantity of clay material overlying the alluvial terrace deposits at the site is not sufficient. The recommended size recharge pool at the San Geronimo Creek site would not require any road relocations.

**Table 2.4-1  
San Geronimo Creek Project Cost and Data Summary**

<b>Physical Data</b>					
Recharge Pool:					
Capacity (acft)	350	1,000	3,500	7,000	14,000
Surface Area (ac)	39	82	183	291	496
Elevation (ft-msl)	1,053.2	1,064.2	1,083.2	1,098.2	1,116.4
Spillway Elevation (ft-msl)	1,053.2	1,069.2	1,088.2	1,103.2	1,121.4
Spillway Width (ft)	773	500	850	1,300	1,500
25-Year Flood Pool <sup>1</sup> :					
Elevation (ft-msl)	1,058.9	1,077.9	1,093.0	1,104.3	1,105.7
Surface Area (ac)	58	155	248	344	361
50-Year Flood Pool <sup>1</sup> :					
Elevation (ft-msl)	1,059.5	1,079.0	1,094.2	1,105.6	1,111.0
100-Year Flood Pool <sup>1</sup> :					
Elevation (ft-msl)	1,060.1	1,080.0	1,095.2	1,106.8	1,116.2
Surface Area (ac)	63	167	265	375	493
Dam Type	RCCChannel	Embankment	Embankment	Embankment	Embankment
Top of Dam Elevation (ft-msl)	1,053.2	1,098.6	1,108.8	1,118.8	1,135.3
Streambed Elevation (ft-msl)	1,030.0	1,030.0	1,030.0	1,030.0	1,030.0
<b>Hydrologic Data</b>					
Recharge Enhancement (acft/yr):					
Drought Conditions	528	630	645	651	661
Average Conditions	2,375	2,880	3,128	3,203	3,231
Median Conditions	1,641	2,015	2,045	2,058	2,083
Drought Average Annual Streamflow Reduction at Saltwater Barrier	147	159	162	164	167
<b>Summary of Project Costs</b>					
Dam, Spillway, and Appurtenant Works	\$2,697,607	\$3,395,518	\$3,552,239	\$4,713,246	\$12,046,699
Road Relocations	\$0	\$0	\$0	\$0	\$0
Land Acquisition	\$160,500	\$261,000	\$356,500	\$459,500	\$596,000
Environmental Mitigation	\$36,869	\$77,519	\$173,000	\$275,098	\$468,896
Engineering, Legal, Financial, and Misc.	\$578,995	\$746,807	\$816,348	\$1,089,569	\$2,622,319
<b>Total Capital Cost</b>	<b>\$3,473,971</b>	<b>\$4,480,845</b>	<b>\$4,898,087</b>	<b>\$6,537,413</b>	<b>\$15,733,914</b>
Annual Capital Cost (25years @ 8% interest)	\$325,511	\$419,855	\$458,951	\$612,556	\$1,474,268
Operations and Maintenance (annual)	\$11,180	\$14,402	\$16,039	\$21,763	\$53,147
Downstream Impacts (annual)	\$444	\$474	\$486	\$492	\$501
<b>Total Annual Cost</b>	<b>\$337,136</b>	<b>\$434,731</b>	<b>\$475,476</b>	<b>\$634,811</b>	<b>\$1,527,916</b>
Annual Cost/Unit Recharge Enhancement:					
Drought Conditions (\$/acft/yr)	\$639	\$690	\$737	\$975	\$2,312
Average Conditions (\$/acft/yr)	\$142	\$151	\$152	\$198	\$473

<sup>1</sup>Flood pools based on reservoirs being empty at beginning of flood.

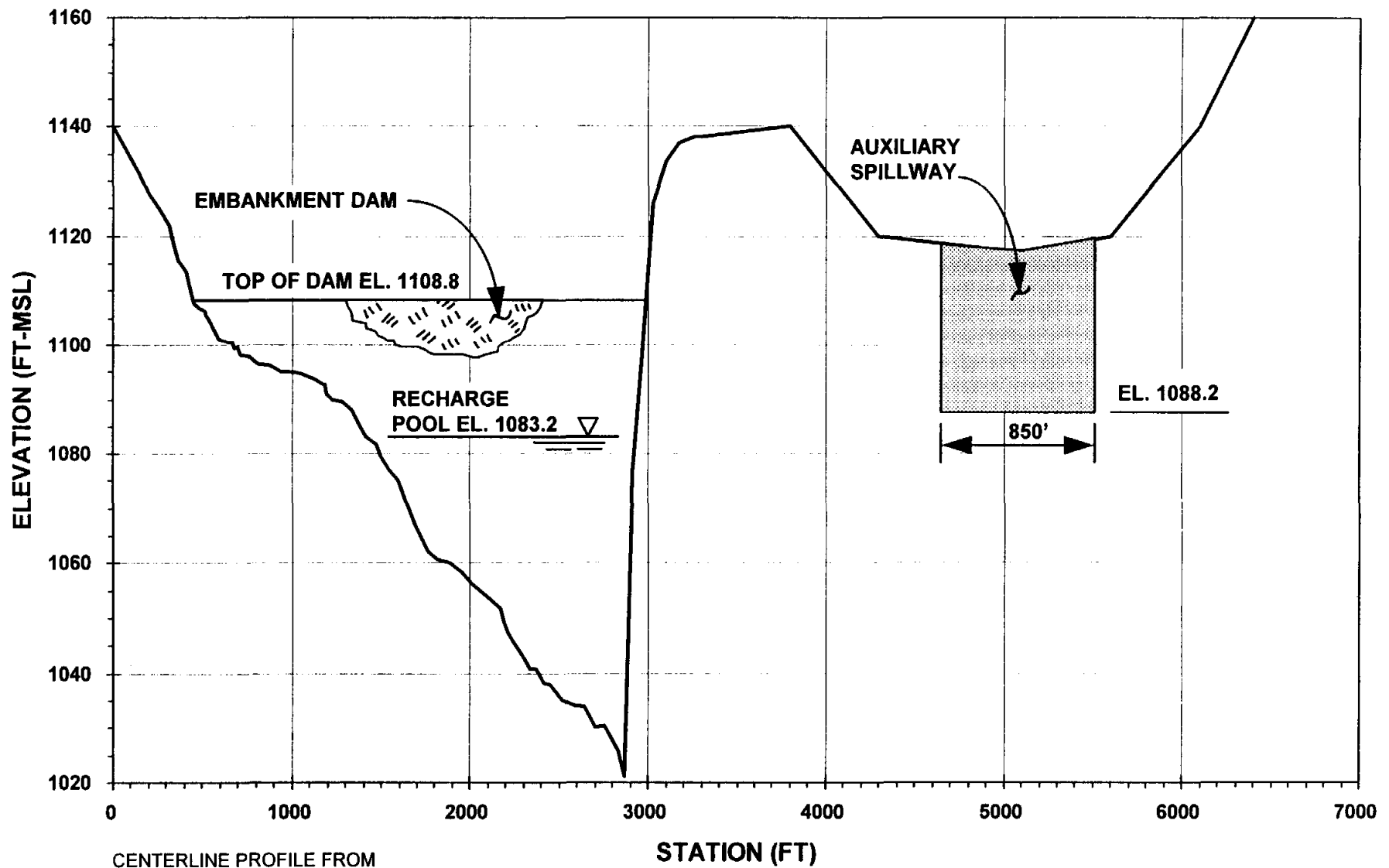

CENTERLINE PROFILE FROM  
 UNITED AERIAL MAPPING, 1994  
 PROFILE IS SHOWN LOOKING DOWNSTREAM

TRANS TEXAS WATER PROGRAM /  
 WEST CENTRAL STUDY AREA

**SAN GERONIMO PROJECT  
 CENTERLINE PROFILE**

GUADALUPE - SAN ANTONIO RIVER BASIN  
 RECHARGE ENHANCEMENT STUDY  
 FEASIBILITY ASSESSMENT



HDR Engineering, Inc.

FIGURE 2.4-3

Much of the data contained in Table 2.4-1 is also presented graphically in Figure 2.4-4. The recommended recharge pool capacity of 3,500 acft results in 3,128 acft/yr of recharge enhancement under average conditions at a unit cost of \$152/acft/yr. Recharge under drought conditions would be increased by 645 acft/yr at a unit cost of \$737/acft/yr.

A graph illustrating the natural recharge and the recharge enhancement resulting from development of the recommended size San Geronimo Creek project is shown in Figure 2.4-5 for the 56-year period of record from 1934 through 1989.

Figure 2.4-6 illustrates the typical performance of direct percolation recharge projects located within the Edwards Aquifer recharge zone. The primary purpose of these recharge projects is to store flood flows and allow the water to percolate over time through cracks and fissures into the aquifer. The figure indicates that, on the average, the recharge pool would be empty 96 percent of the time. Less than 1 percent of the time, storage would be greater than 7 percent of the design capacity.

#### 2.4.6 Implementation Issues

##### Requirements Specific to Surface Recharge Structures

1. It will be necessary to obtain these permits:
  - a. TNRCC Water Right and Storage Permit.
  - b. U.S. Army Corps of Engineers Sections 10 and 404 dredge and fill permits for the reservoir.
  - c. GLO Sand and Gravel Removal permits.
  - d. GLO Easement for use of state-owned lands.
  - e. Coastal Coordination Council review.
  - f. TPWD Sand, Gravel, and Marl permit.
2. Permitting, at a minimum, will require these studies:
  - a. Bay and estuary inflow impact.
  - b. Habitat mitigation plan.
  - c. Environmental studies.
  - d. Cultural resource studies.
  - e. Study of impact on karst geology organisms from sustained recharge.
  - f. Other environmental studies.
3. Land will need to be acquired through either negotiations or condemnation.
4. Detailed field investigations of the right abutment to:
  - a) determine the cause of the rock ablation that is occurring; and
  - b) evaluate the potential for leakage through the narrow ridge.

RECHARGE ENHANCEMENT SUMMARY

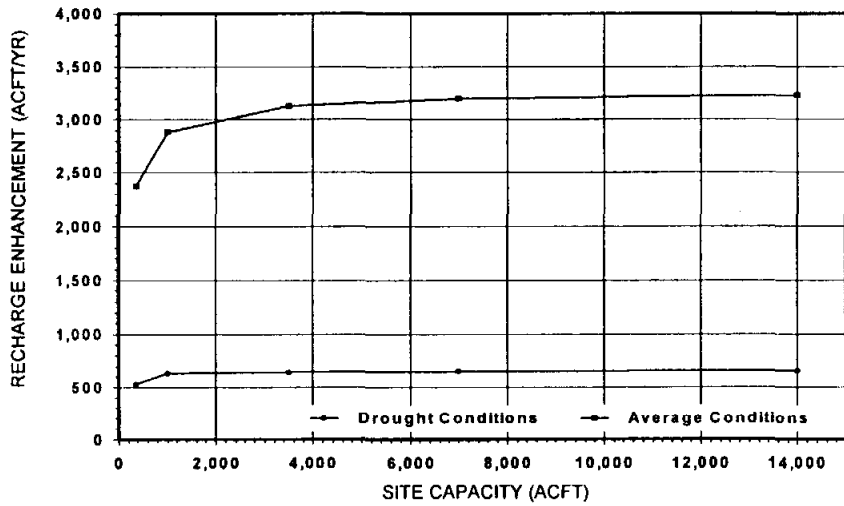

DOWNSTREAM IMPACT SUMMARY

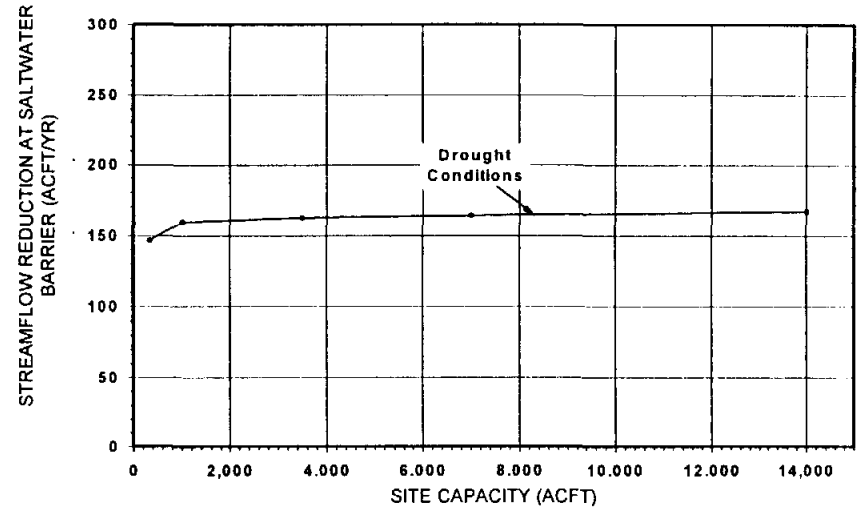

RECHARGE PROJECT COST SUMMARY

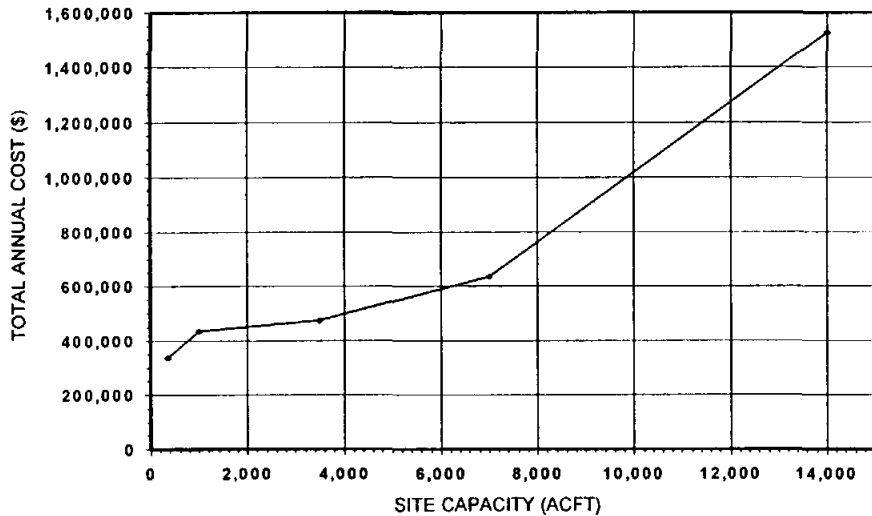

RECHARGE PROJECT OPTIMIZATION SUMMARY

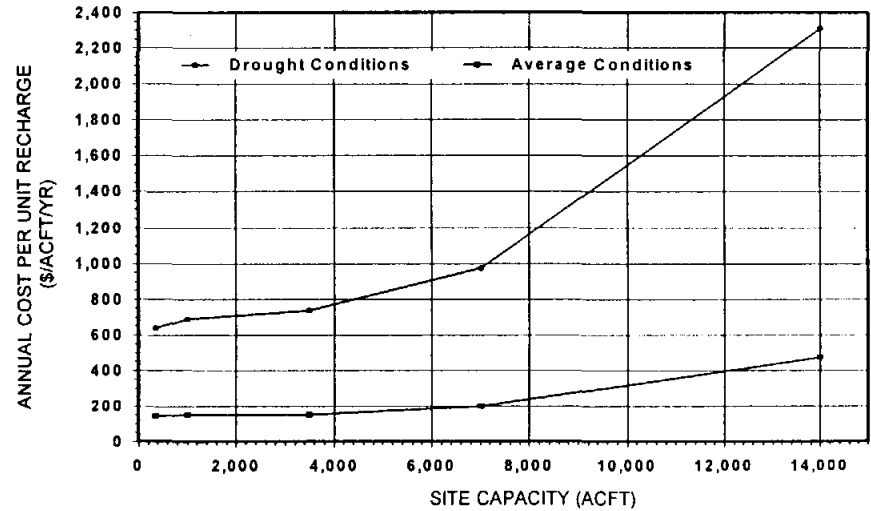

TRANS TEXAS WATER PROGRAM /  
WEST CENTRAL STUDY AREA

**SAN GERONIMO CREEK  
PROJECT EVALUATION  
SUMMARY**



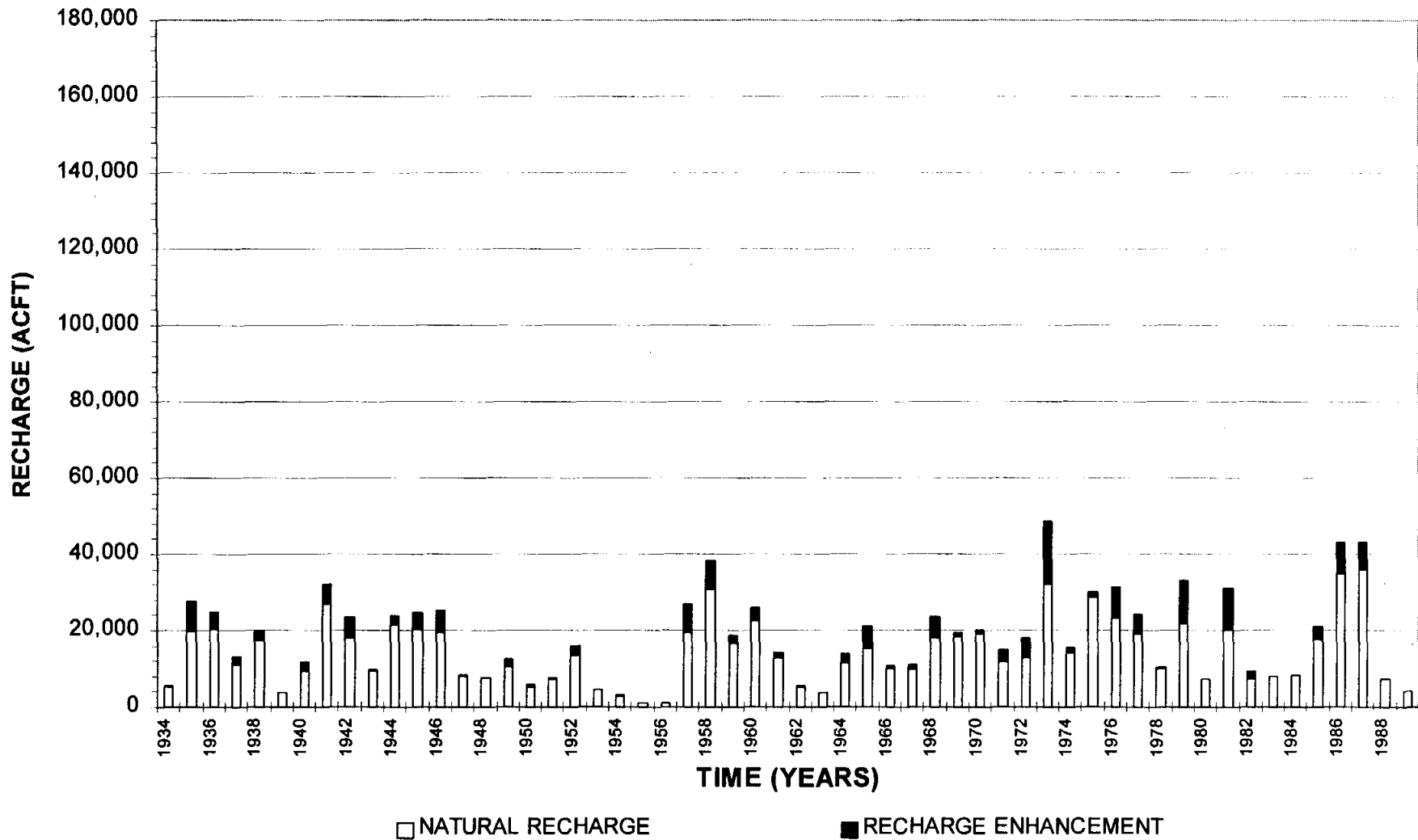

TRANS TEXAS WATER PROGRAM /  
WEST CENTRAL STUDY AREA

**SAN GERONIMO CREEK PROJECT  
ANNUAL RECHARGE**



HDR Engineering, Inc.

GUADALUPE - SAN ANTONIO RIVER BASIN  
RECHARGE ENHANCEMENT STUDY  
FEASIBILITY ASSESSMENT

FIGURE 2.4-5



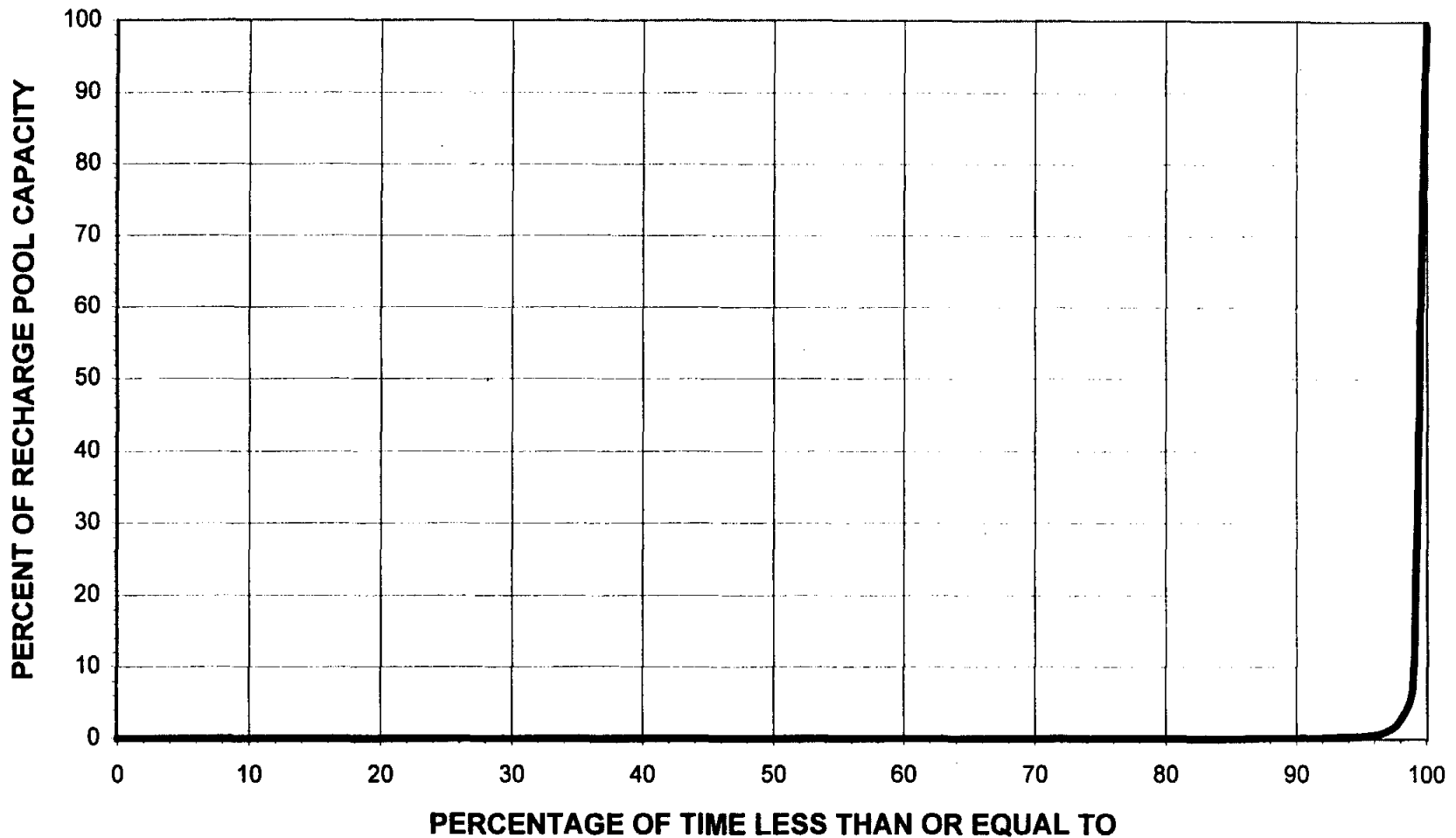

**RECHARGE POOL CAPACITY = 3,500 ACFT**

*GUADALUPE - SAN ANTONIO RIVER BASIN  
RECHARGE ENHANCEMENT STUDY  
FEASIBILITY ASSESSMENT*



HDR Engineering, Inc.

**TRANS TEXAS WATER PROGRAM /  
WEST CENTRAL STUDY AREA  
SAN GERONIMO CREEK  
PROJECT  
STORAGE FREQUENCY**

**FIGURE 2.4-6**

(This page intentionally left blank.)

## 2.5 Northern Bexar / Medina County Sites (L-21E)

### 2.5.1 Description of Alternative

Previous studies<sup>44</sup> proposed the development of a number of small, Type 2 direct recharge projects in the western part of the Guadalupe - San Antonio (GSA) River Basin. Eleven sites were initially identified as part of this study, however, field reconnaissance indicated that only five were viable. The others were ruled out because of their proximity to urban development and/or other constraints (such as reports of limited recharge rates).

The five smaller projects, located in northwestern Bexar County and northeastern Medina County, were evaluated for their recharge enhancement potential as a group. The five proposed projects are, from east to west: Salado No. 3, Culebra, Government Canyon, Limekiln, and Deep Creek (see Figure 2.5-1). Each of the proposed dams is located near the downstream edge of the Edwards Aquifer recharge zone, and was sized based on its ability to store a volume of water equal to the volume of runoff from a 100-year flood event. The elevation of the creek bed at the proposed dams ranges from 958 ft-msl at Salado No. 3 to 1,051 ft-msl at Culebra. The combined drainage area controlled by the dam sites is approximately 30 square miles.

### 2.5.2 Recharge Enhancement Hydrology

The Northern Bexar / Medina County projects were operated on a monthly timestep, honoring all downstream existing water rights. The GSA River Basin Model calculates recharge in the basins that include SCS/FRS projects, assuming that 100 percent and 70 percent of the volume of water impounded in the respective normal and active pools of the SCS/FRS is recharged. The volume of water draining to these structures is computed using the ratio of the watershed controlled by the structures to the total watershed area at the model control point where natural streamflows are tabulated. The new projects in this study were analyzed in a similar fashion with one exception. For the new projects, it was assumed that there would be no

---

<sup>44</sup> HDR, "Guadalupe - San Antonio River Basin Recharge Enhancement Study," Vols. 1,2, and 3, Edwards Underground Water District, September, 1993.

(This page intentionally left blank.)

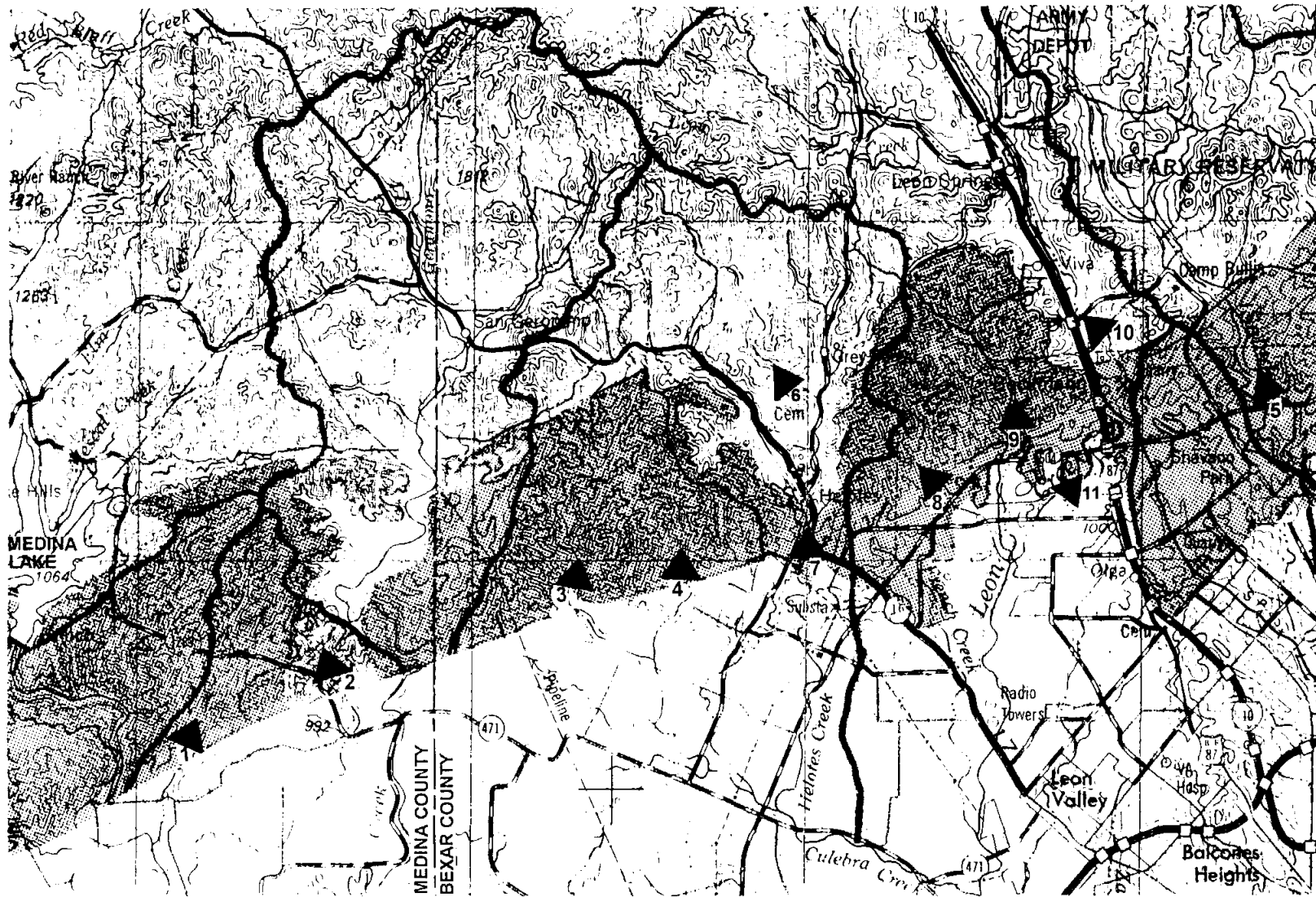

**LEGEND:**

- ▲ SITES SELECTED FOR STUDY
- 1 - Deep Creek \*
- 2 - Limekiln \*
- 3 - Government Canyon
- 4 - Culebra \*
- 5 - Salado Creek Site No. 3 \*
  
- △ SITES NOT RECOMMENDED FOR STUDY
- 6 - Chimenea (Type 1)
- 7 - Helotes Gravel Pit
- 8 - Huesta
- 9 - Babcock
- 10 - Upper Leon (Type 1)
- 11 - Lower Leon

\* Sites not observed

active pool, and 100 percent of the water captured in the reservoir in a given month was structures. Total recharge for the model control point watersheds in which these projects are located include natural recharge upstream and downstream of the projects and water captured and recharged in the projects.

A combined storage capacity of 12,409 acft for all five reservoirs was simulated. The range of recharge pool capacities for the individual projects is 490 acft for the Limekiln project to 4,977 for the Government Canyon site. The projects also include a 767 acft site on Culebra Creek, a 1,983 acft site on Deep Creek, and a 4,192 acft site in the Salado Creek watershed (previously identified by the SCS as Site No. 3 of their SCS/FRS Program for the Salado Creek Watershed). Long-term average recharge enhancement (1934-89) for the combined projects was 2,429 acft/yr and drought average recharge enhancement (1947-56) was computed to be 501 acft/yr.

### 2.5.3 Environmental Issues

The five Northern Bexar and Medina County projects are located along the Balcones escarpment in northwestern Bexar County and northeastern Medina County. The land within these Counties is described predominantly as live oak – Ashe juniper woods and primarily used for cattle ranching.

All of the proposed project sites are located on small intermittent headwater streams in the Balcones Fault Zone, on the Balcones Escarpment, upstream of the Blackland Prairies and South Texas Plains.<sup>45,46</sup> The Balcones Escarpment forms the southern and eastern boundary of the uplifted Edwards Plateau. It is characterized by a complex of porous, faulted limestones in streambeds, sinkholes, and fractures which allow substantial volumes of water to flow into the Edwards Aquifer (see Appendix B, Section 2.2 Habitats and Biogeography for a description of the typical vegetation found within each of the vegetational areas). The Balcones Fault is a transitional zone between the Edwards Plateau, Blackland Prairies, and South Texas Plains and forms unique habitats favorable to a number of rare and protected species. The common isolated

---

<sup>45</sup> Omernik, J.M. 1987. Ecoregions of the conterminous United States. *Annals of the Association of American Geographers* 77:11-125.

<sup>46</sup> Gould, F.W. 1962. *The grasses of Texas*. Texas A&M University Press. College Station, Texas.

springs and caves favor endemism where organisms become narrowly adapted to the stable, local environment.

The surface geology of the five sites is similar in that all sites are located on Cretaceous Glen Rose and Edwards limestones.<sup>47</sup> Although slight variations may occur between sites, the soil units that have formed over these limestones and that occur within the proposed recharge pools are predominantly Tarrant associations and Tarrant – Rock Outcrop associations.<sup>48</sup> These soils are described as very shallow to shallow, well drained upland soils with rapid surface runoff that are typically suited for wildlife habitat and rangeland.

Land uses, habitat types, and wetland occurrences within the study area were identified and evaluated using available literature and a variety of other sources, including the Texas Natural Resources Information System's aerial photography and map database; Texas Highway Department aerial photography; Texas Parks and Wildlife Department (TPWD), Resource Protection Division's data and mapping files for endangered, protected and sensitive resources; Texas Organization for Endangered Species (TOES) listings of endangered, protected and sensitive resources; U.S. Fish and Wildlife Service (USFWS) National Wetland Inventory (NWI) maps; information available from the Edwards Aquifer Research and Data Center; USGS library resources; Texas Natural Resource Conservation Commission (TNRCC) publications and library; consultant reports; and the general biological literature, particularly descriptions of the habitat requirements of species listed as Endangered or Threatened by either the U.S. Department of the Interior or the State of Texas. This database, including archeological sites, significant environmental features, state natural areas, protected species and potential wetland areas is maintained at Paul Price Associates, Inc. on USGS 7.5 minute quadrangles.

Bexar County is largely urban and serves as a wholesale, retail, and distribution center for a wide area.<sup>49</sup> San Antonio is the tenth largest city in the nation and second largest city in Texas. Tourism and federal military expenditures represent a significant contribution to the economy of the area. Within Medina County, economy is based on agribusiness, tourism, oil, and

---

<sup>47</sup> Fisher, W.L. 1983. Geologic Atlas of Texas: San Antonio Sheet. Bureau of Economic Geology. The University of Texas at Austin. Austin, Texas.

<sup>48</sup> Taylor, F.B., R.B. Hailey, and D.L. Richmond. 1991. Soil Survey of Bexar County, Texas. United States Department of Agriculture Natural Resources Conservation Service.

<sup>49</sup> Clements, J. 1988. Texas Facts: A Comprehensive Look at Texas Today County by County. Clements Research II, Inc. Dallas, Texas.

manufacturing and agriculture is primarily centered upon cattle ranching and feeding.<sup>50</sup> The population density of Medina County is about 25 percent that of Bexar County. The climate of this subtropical region is characterized by hot, humid summers with variable winters. The number of days with temperatures over 90° F averages over 110 per year and the growing season averages over 260 days. Thunderstorms, peaking in late spring and early fall, account for much of the rainfall which ranges from 29 to 34 inches in the two county area. For a more detailed description regarding land use and economy, see Appendix B, Section 2.6.

The vegetational type of the proposed Bexar and Medina Counties sites is described as live oak – Ashe juniper parks<sup>51</sup> with land cover predominantly shrubs, brush, park, and grass based on the soils surveys of Bexar and Medina Counties (See Appendix B, Table 4 for estimated acreages of each proposed recharge site).<sup>52</sup> The habitat types on only the Government Creek site have been verified by on-site inspection. The proposed recharge project sites on Deep Creek, Limekiln Creek, Culebra Creek, and Salado Creek have not been verified by on-site surveys. It is suspected, however, due to the close proximity of all proposed sites and the similarity of the geology and soils, that the habitats and land uses will be similar to that of Government Creek. On-site surveys will be needed to accurately characterize the landuse and habitats found within each proposed recharge project site.

The actual creek bottom of the Government Creek site itself is about 60 feet wide and composed predominantly of gravel and cobble.<sup>53</sup> The terraces along both sides of the creek bottom are heavily wooded with some very large oaks (*Quercus* spp.) and cedar elms (*Ulmus crassifolia*). Chinaberry (*Melia azedarach*) was found growing within the stream channel. The downslopes of the canyon are heavily canopied with what appears to be an oak – Ashe juniper wood habitat. Upstream from the proposed damsite, a large depression was observed. This depression would be a deep pool, if there were any water in the creek. It is suspected that this

---

<sup>50</sup> NFIB. 1987. The Climates of Texas Counties. Natural Fibers Information Center. The University of Texas. Austin, Texas.

<sup>51</sup> McMahan, C.A., R.G. Frye and K.L. Brown. 1984. The Vegetation Types of Texas Including Crop. Wildlife Division, Texas Parks and Wildlife Department, Austin, Texas.

<sup>52</sup> Taylor, F.B., R.B. Hailey, and D.L. Richmond. 1991. Soils Survey of Bexar County, Texas. United States Department of Agriculture, Natural Resources Conservation Service.

<sup>53</sup> Price, P. 1994. Field notes from a visit to the site. Paul Price Associates, Inc. Austin, Texas. August 1-2, 1994.



pool does not hold water for a long period of time. A thin algal crust was seen on the rock slabs that made up the pool.

Wetland areas affected by the periodic inundation to the recharge pool levels proposed are presented in Table 4 of Appendix B. Approximately 3.1 and 7.2 acres of intermittent, temporarily flooded riverine habitat will be affected at the proposed Deep Creek and Salado Creek sites, respectively. Less than one acre of intermittent headwater drainages, not classified by NWI maps would be periodically inundated at each of the Limekiln Creek, Government Creek, and Culebra Creek sites.

Appendix B, Table 5 presents the endangered and threatened species and important habitats reported as occurring within or near each of the proposed project sites. Most of the reported sightings are associated with Government Creek, which is located within Government Canyon State Park. Within the proposed Government Creek site, Golden-cheeked Warblers (*Dendroica chrysoparia*) have been reported, as well as the important habitats of the Texas Oak Series and Ashe juniper – Oak Series. Other important species from the area of the proposed Government Creek site include the Texas Salamander (*Eurycea neotenes*), Texas Amorphia (*Amorpha roemeriana*) as well as the important habitat of Government Canyon Bat Cave. The Comal blind salamander, a TPWD and TOES threatened species has been reported within two miles of the proposed Salado Creek recharge site, and the TOES Category V listed Bracted twistflower (*Strepanthos bractatus*) has been reported from the proposed Deep Creek site.

Because no on-site surveys of the recharge sites, with the exception of Government Creek, have been performed and there have been numerous reported endangered, threatened, and important species from the area, intensive surveys of the project sites will be needed to accurately describe the habitats to determine the possibility of any associated threatened, endangered, or important species or important habitats. The nature of the geology of the area requires the characterization of karst features by a karst biologist to determine the presence or absence of any associated protected or endangered species (see Appendix B, Sections 2.2 and 2.3 for karst discussions). Other important species that might occur in the recharge project sites may include Cave myotis (*Myotis velifer*), Black-capped vireo (*Vireo atricapillus*), Timber rattlesnake (*Crotalus horridus*), Texas indigo snake (*Drymarchon corais erebennus*), Texas tortoise

(*Gopherus berlandieri*), and various amphibians and invertebrates associated with karst and spring environments (Appendix B, Tables 1 and 2).

One special area of interest is the approximately 5,860-acre area surrounding the proposed Government Creek recharge. This area is Government Canyon State Park. In 1993, a 4,379-acre tract of land was purchased by TPWD with an additional 1,121 acres purchased in 1996.<sup>54</sup> Current plans for the park include camping, trail use, and a proposed interpretive vegetation center, to be developed in cooperation with the City of San Antonio, Edwards Aquifer Authority, and San Antonio Water System. Numerous studies have taken place within the park to determine vegetational habitats, endangered species surveys, cultural resources surveys, and karst feature surveys. These surveys have found numerous karst features located within the property, mostly at the higher elevations<sup>55</sup>, numerous cultural resources sites, and areas of oak – Ashe juniper habitat suitable for Golden-cheeked warblers, as well as sightings of these warblers. Although Black-capped vireos are listed as found within the area of Bexar County, none have been sighted within Government Canyon State Park for over 20 years.<sup>56</sup> The only permanent disturbance expected to this site will be the impoundment structure.

A search of the database at the Texas Archeological Research Laboratory (TARL) revealed numerous archeological sites recorded from within the general area of the proposed project sites. Cultural properties have been recorded from within two of the sites, Government Creek and Salado Creek, as a result of studies that have been performed on these sites. Prior to inundation it must be determined if any cultural properties, other than the ones recorded, are located within the project area by an on-site survey. Once all cultural properties within the project area are identified, they will undergo preliminary assessment, during the survey, to determine the significance and potential for eligibility in the Register of Historic Places. Because the assessment methods used during the survey are limited in their ability to determine significance potential, some sites may need to be subjected to more extensive test-level investigations before their eligibility can be adequately determined. Once cultural resource

---

<sup>54</sup> Beckom, C. 1997. Personal Communication.

<sup>55</sup> Hulsey, D. 1994. Field notes from karst survey to the site. Paul Price Associates, Inc. Austin, Texas. September 3, 1994.

<sup>56</sup> Beckom, C. 1997. Personal Communication.

properties are determined to be eligible, they must either enter mitigation through avoidance or undergo scientific data recovery (see Appendix B, Section 2.7).

In summary, the environmental concerns associated with the five small proposed recharge projects include intensive field surveys to determine the presence and evaluation of the oak-Ashe juniper woods and parks within the project areas for utilization by protected species, evaluation of the impact of inundation on important habitats such as Government Canyon Bat Cave, and the evaluation of the historic significance of cultural resources sites (Appendix B, Table 6). Estimated environmental related costs for the Northern Bexar and Medina County projects can be found in Appendix B, Table 7. These estimates are based on each respective recharge pool levels shown in Appendix B, Table 4. Environmental report costs include baseline surveys, a comprehensive Environmental Assessment, and permit support.

#### 2.5.4 Water Quality and Treatability

[To be completed in subsequent phases of study.]

#### 2.5.5 Engineering and Costing

The five proposed recharge dams were sized to contain the 100-year flood event prior to engaging the auxiliary spillway, as was done for the numerous SCS/FRS projects that exist throughout Bexar, Comal, and Hays Counties. Recharge pool capacities (100-year flood volumes) for the five proposed sites range from 490 to 4,977 acre-feet (acft). The combined recharge pool capacity is 12,409 acft. Table 2.5-1 provides pertinent physical, hydrologic, and cost data for the five recharge enhancement projects evaluated.

The embankment dam with side-channel spillway design, presented in Appendix A, was utilized for each site. Sufficient construction materials were assumed to be available from the side-channel spillway excavations and from sources within a reasonable haul distance from the project vicinity. Spillway widths ranging from 100 to 300 feet would be required to safely pass the probable maximum flood (PMF) calculated at each project. Dam heights range from 60 to 120 feet, and flow depths through the side-channel spillways range from 13 to 25 feet to pass the PMF. No road relocations were required at the proposed sites.

**Table 2.5-1  
Northern Bexar/Medina County Projects Cost and Data Summary**

	Deep Creek	Culebra	Government Canyon	Limekiln	Salado #3
<b>Physical Data</b>					
Recharge Pool:					
Capacity (acft)	1,983	767	4,977	490	4,192
Surface Area (ac)	65	49	216	28	247
Elevation (ft-msl)	1,065.0	1,093.1	1,075.5	1,094.0	1,018.3
Spillway Elevation (ft-msl)	1,065.0	1,093.1	1,075.5	1,094.0	1,018.3
Spillway Width (ft)	150	100	300	100	600
Dam Type	Embankment	Embankment	Embankment	Embankment	Embankment
Top of Dam Elevation (ft-msl)	1,087.8	1,110.8	1,099.6	1,107.2	1,042.8
Streambed Elevation (ft-msl)	968.0	1,051.0	1,015.0	1,047.0	958.0
<b>Hydrologic Data<sup>1</sup></b>					
Recharge Enhancement (acft/yr):					
Drought Conditions			501		
Average Conditions			2,429		
Median Conditions			1,377		
Drought Average Annual Streamflow Reduction at Saltwater Barrier			243		
<b>Summary of Project Costs</b>					
Dam, Spillway, and Appurtenant Works	\$2,699,340	\$1,340,101	\$4,295,857	\$946,984	\$3,275,130
Road Relocations	\$0	\$0	\$0	\$0	\$0
Land Acquisition	\$65,000	\$147,000	\$648,000	\$28,000	\$741,000
Environmental Mitigation	\$165,100	\$163,600	\$190,500	\$162,200	\$183,000
Engineering, Legal, Financial, and Misc.	\$585,888	\$330,140	\$1,026,871	\$227,437	\$839,826
<b>Total Capital Cost</b>	<b>\$3,515,328</b>	<b>\$1,980,841</b>	<b>\$6,161,228</b>	<b>\$1,364,621</b>	<b>\$5,038,956</b>
Annual Capital Cost (25 years @ 8% interest)	\$329,386	\$185,605	\$577,307	\$127,865	\$472,150
Operations and Maintenance (annual)	\$11,447	\$5,850	\$19,343	\$4,068	\$15,571
Site Total Annual Cost	<u>\$340,834</u>	<u>\$191,455</u>	<u>\$596,651</u>	<u>\$131,933</u>	<u>\$487,721</u>
Downstream Impacts (annual) <sup>1</sup>			<u>\$729</u>		
<b>Total Annual Cost<sup>1</sup></b>			<b>\$1,749,322</b>		
Annual Cost/Unit Recharge Enhancement <sup>1</sup> :					
Drought Conditions (\$/acft/yr)			\$3,492		
Average Conditions (\$/acft/yr)			\$720		

<sup>1</sup>Hydrologic data, downstream impacts, total annual cost, and unit costs shown for all five projects combined.

The combined recharge pool capacity of 12,409 acft results in only 2,429 acft/yr of recharge enhancement under average conditions at a very high unit cost of \$720/acft/yr. Recharge under drought conditions would be increased by only 501 acft/yr at an extremely high unit cost of \$3,492/acft/yr. Although the recharge enhancement potential for these projects as studied appears to be minimal and expensive, other significant benefits, such as flood control, may be derived by developing these projects. The projects may also be utilized as discharge locations for water diverted from other sources to enhance recharge of the Edwards Aquifer.

#### 2.5.6 Implementation Issues

##### Requirements Specific to Surface Recharge Structures

1. It will be necessary to obtain these permits:
  - a. TNRCC Water Right and Storage Permit.
  - b. U.S. Army Corps of Engineers Sections 10 and 404 dredge and fill permits for the reservoir.
  - c. GLO Sand and Gravel Removal permits.
  - d. GLO Easement for use of state-owned lands.
  - e. Coastal Coordination Council review.
  - f. TPWD Sand, Gravel, and Marl permit.
2. Permitting, at a minimum, will require these studies:
  - a. Bay and estuary inflow impact.
  - b. Habitat mitigation plan.
  - c. Environmental studies.
  - d. Cultural resource studies.
  - e. Study of impact on karst geology organisms from sustained recharge.
  - f. Other environmental studies.

### **3.0 RECHARGE ENHANCEMENT PROGRAM DEVELOPMENT**

A range of storage capacities was examined for each proposed recharge enhancement project (except the Northern Bexar / Medina County projects) in order to determine an optimum size. In determining the range of storage capacities to evaluate, consideration was given to several factors including watershed area, site topography, and known site constraints that would increase project costs, such as major road relocations and inundation of structures. Five different storage capacities were evaluated for each of the four major recharge projects. For the five smaller projects in Northern Bexar and Medina County, the recharge pool volumes were set equal to the 100-year flood volume computed for each site.

The optimum size storage capacity for each major project was selected on the basis of the minimum unit cost of recharge enhancement under long-term (1934-1989) average conditions. Applying this criteria, the smallest storage capacity evaluated at each of the major projects was determined to be the optimum size.

During the individual project evaluations, it became apparent that the unit cost of recharge enhancement at the Upper Blanco site is considerably more expensive than that for the Lower Blanco site. Although the topography of the Upper Blanco site is very favorable for construction of a dam, the amount of water that could be recharged via releases across the downstream recharge zone and diversion from the reservoir to the Upper San Marcos watershed structures was significantly less than recharge enhancement at the Lower Blanco site. This resulted in unit costs for recharge enhancement, under both average and drought conditions, that were significantly higher than unit costs at the Lower Blanco site for all storage capacities evaluated. Given this, the Upper Blanco site was eliminated from consideration in the development of the recharge enhancement program for the Guadalupe - San Antonio River Basin. It should be noted, however, that the Upper Blanco project may have indirect water supply benefits such as more definitive control (with respect to timing) of the water to be used for recharge enhancement.

#### **3.1 Sizing of Projects in Guadalupe - San Antonio River Basin**

On the basis of this study, the Cibolo Creek, Lower Blanco, and San Geronimo Creek recharge enhancement projects are believed to be ready to move forward to a preliminary design

and permitting phase at this time. The recommended size of each major project was determined by examining the unit cost of recharge enhancement under average conditions for each of the storage capacities evaluated. The sizing procedure began by selecting the storage capacity of each project having the lowest unit cost (i.e., optimum size) and continued by enlarging the projects up to the maximum storage capacity considered.

Table 3.1-1 illustrates this process. The Cibolo Creek project at its optimum size represents the lowest unit cost of recharge enhancement of the three (Upper Blanco excluded) major projects. The next most cost effective quantity of recharge enhancement is obtained by developing the Lower Blanco project at its optimum size. The third most cost effective increment of recharge enhancement is obtained by enlarging the storage capacity of the Cibolo Creek project from 1,000 to 5,000 acft. The San Geronimo Creek project at its optimum (smallest) size enters the program ranked fourth. The program development continues by evaluating the incremental cost to enlarge each project up to the maximum storage capacity considered for each of the projects.

Graphical presentations of the recharge program development are shown in Figures 3.1-1 and 3.1-2. The points on the graphs correspond to the unit or incremental cost rankings as presented in Table 3.1-1. A fairly well defined break point occurs in the program development process at the 11th ranked project. This point represents the Lower Blanco project developed to its full potential storage capacity of 50,000 acft. Beyond this point, the unit cost of recharge enhancement begins to increase sharply, as relatively small amounts of additional recharge enhancement are added to the program. Figure 3.1-2 illustrates that virtually no additional recharge enhancement during the 10-year drought period (1947-1956) is added beyond the 11th ranked project.

The 12th step in the program development represents enlarging the storage capacity at the Cibolo Creek project from 10,000 to 50,000 acft. Detailed geohydrological investigations will be necessary for this larger size to determine if the potential environmental and socioeconomic impacts to Bracken Bat Cave and Natural Bridge Caverns<sup>1</sup> are worth the relatively small

---

<sup>1</sup> Natural Bridge Caverns. Various letters to U.S. National Park Service and San Antonio River Authority, April 4, 1995 to April 2, 1996.

**Table 3.1-1**  
**Guadalupe-San Antonio River Basin**  
**Recharge Enhancement Program Development**

Cost Ranking <sup>1</sup>	Average Unit or Incremental Cost to Enlarge (\$/acft/yr)	Project	Optimum or Enlarged Storage Capacity (acft)	Recharge Enhancement (acft/yr)	
				Average Conditions	Drought Conditions
1	80	Cibolo Creek	1,000	3,787	382
2	104	Lower Blanco	<u>3,500</u>	<u>22,129</u>	<u>9,789</u>
		Subtotals	4,500	25,916	10,171
3	120	Cibolo Creek	<u>5,000</u>	<u>4,138</u>	<u>550</u>
		Subtotals	8,500	30,054	10,721
4	142	San Geronimo	<u>350</u>	<u>2,375</u>	<u>528</u>
		Subtotals	8,850	32,429	11,249
5	193	San Geronimo	<u>1,000</u>	<u>505</u>	<u>102</u>
		Subtotals	9,500	32,934	11,351
6	164	San Geronimo	<u>3,500</u>	<u>248</u>	<u>15</u>
		Subtotals	12,000	33,182	11,366
7	196	Lower Blanco	<u>10,000</u>	<u>6,348</u>	<u>3,471</u>
		Subtotals	18,500	39,530	14,837
8	183	Lower Blanco	<u>17,500</u>	<u>5,078</u>	<u>2,225</u>
		Subtotals	26,000	44,608	17,062
9	83	Lower Blanco	<u>35,000</u>	<u>9,349</u>	<u>3,807</u>
		Subtotals	43,500	53,957	20,869
10	201	Cibolo	<u>10,000</u>	<u>1,808</u>	<u>553</u>
		Subtotals	48,500	55,765	21,422
11	230	Lower Blanco	<u>50,000</u>	<u>6,862</u>	<u>3,198</u>
		Subtotals	63,500	62,627	24,620
12	288	Cibolo Creek	<u>50,000</u>	<u>3,116</u>	<u>984</u>
		Subtotals	103,500	65,734	25,604
13	720	Bexar/Medina Sites	<u>12,409</u>	<u>2,429</u>	<u>501</u>
		Subtotals	115,909	68,172	26,105
14	2,124	San Geronimo	<u>7,000</u>	<u>75</u>	<u>6</u>
		Subtotals	119,400	68,247	26,111
15	31,897	San Geronimo	<u>14,000</u>	<u>28</u>	<u>10</u>
		Subtotals	126,409	68,275	26,121

<sup>1</sup>Ranking is based on unit or incremental cost of recharge enhancement for average conditions.



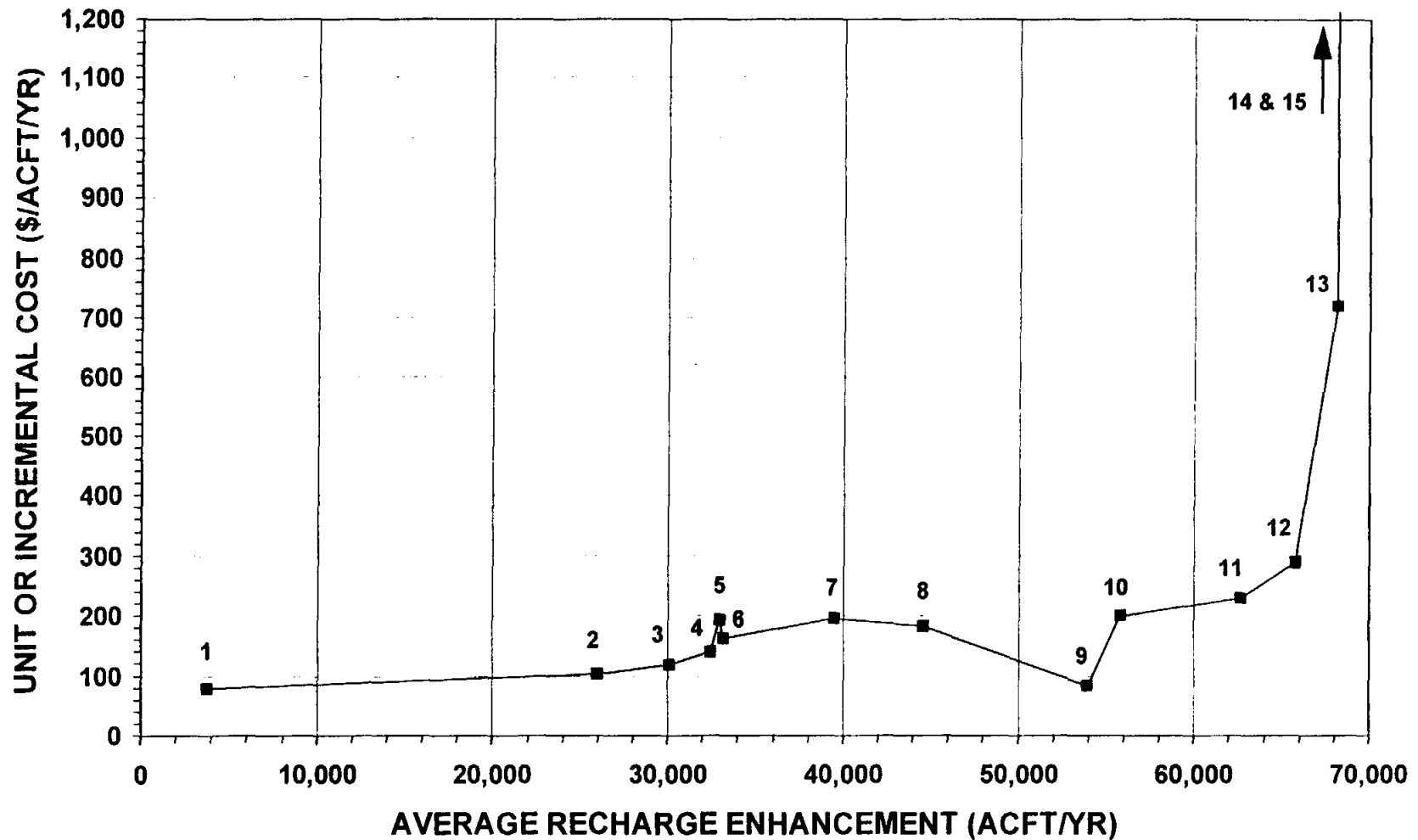

TRANS TEXAS WATER PROGRAM /  
WEST CENTRAL STUDY AREA

**RECHARGE ENHANCEMENT  
PROGRAM DEVELOPMENT  
COST SUMMARY**



HDR Engineering, Inc.

GUADALUPE - SAN ANTONIO RIVER BASIN  
RECHARGE ENHANCEMENT STUDY  
FEASIBILITY ASSESSMENT

FIGURE 3.1-1

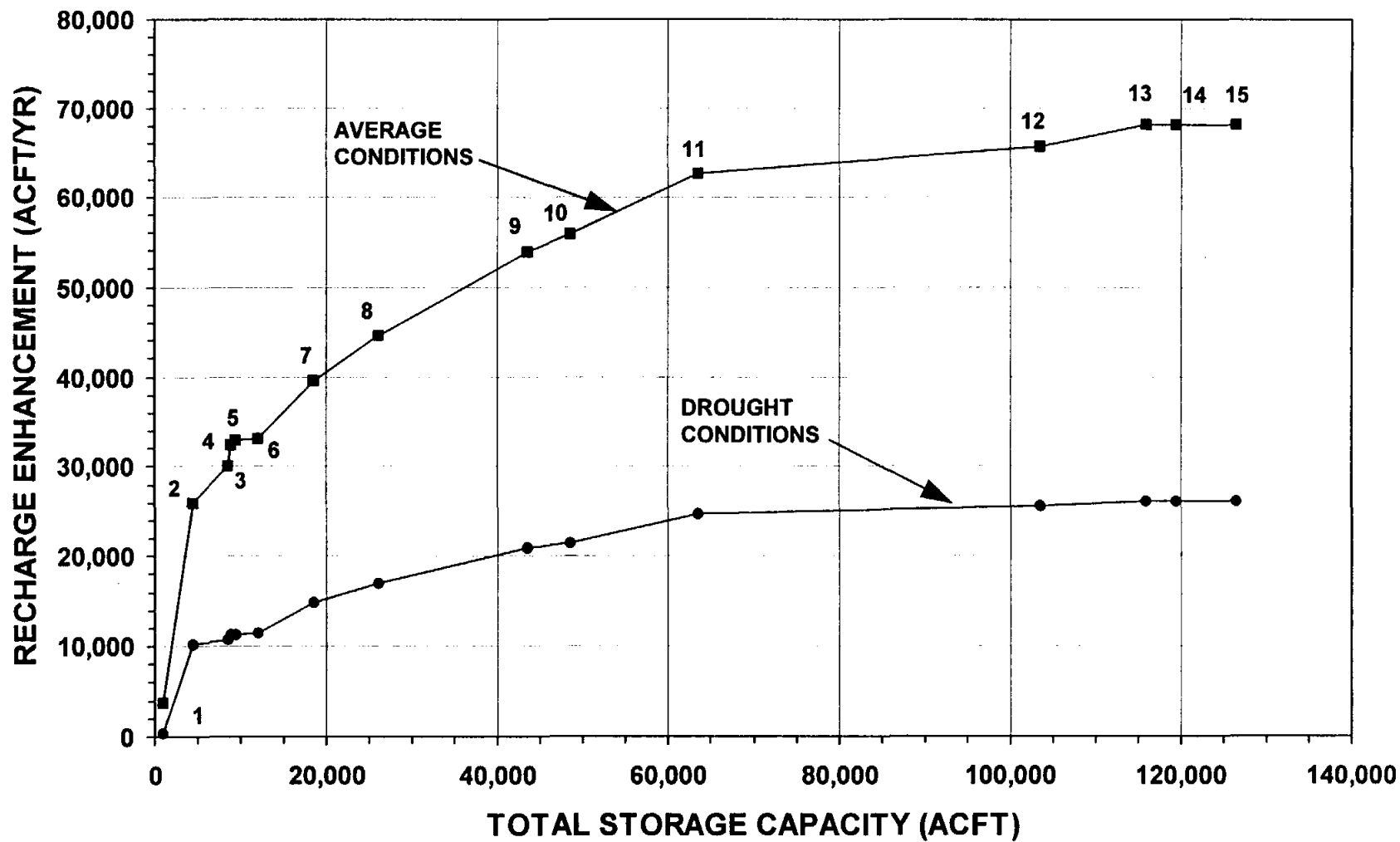

TRANS TEXAS WATER PROGRAM /  
WEST CENTRAL STUDY AREA

**RECHARGE ENHANCEMENT  
PROGRAM DEVELOPMENT  
STORAGE SUMMARY**



HDR Engineering, Inc.

FIGURE 3.1-2

amounts of additional average and drought recharge enhancement obtained by enlarging the project. Other potential benefits, although not addressed by this study, may exist for an enlarged project. These may include flood control and use of the enlarged recharge pool as a discharge location for imported water.

The group of five smaller Northern Bexar / Medina County projects enters the program ranked 13th, with a unit cost for recharge enhancement of \$720/acft/yr under average conditions, as shown in Table 3.1-1. Although the cost of recharge enhancement appears to be very high for these smaller projects, other benefits such as flood control, may be derived from the development of these projects in the growing northwestern suburbs of San Antonio. These projects may also be utilized as discharge locations for water imported to enhance recharge and/or recirculation of Edwards Aquifer springflow.

### **3.2 Summary of Recommended Recharge Enhancement Program for Guadalupe - San Antonio River Basins (L-21)**

The recommended recharge enhancement program is comprised of the Cibolo Creek project sized at 10,000 acft, Lower Blanco at 50,000 acft with diversion to the Upper San Marcos watershed flood retardation structures, and San Geronimo Creek at 3,500 acft. A summary of the recommended program is presented in Table 3.2-1. Development of this program would provide 62,627 acft/yr of recharge enhancement under average conditions at an average unit cost of \$135/acft/yr (\$0.41 per 1,000 gallons). Recharge enhancement under drought conditions would be 24,620 acft/yr at an average unit cost of \$344/acft/yr (\$1.06 per 1,000 gallons). The total capital cost of the recommended recharge enhancement program is estimated to be \$81.8 million and the total annual cost for this program would be about \$8.5 million.

A graph showing how the annual recharge to the Edwards Aquifer occurring in the Guadalupe - San Antonio River Basin would be affected by implementation of the recommended program is presented in Figure 3.2-1. This figure illustrates natural recharge to the Edwards Aquifer and recharge enhancement resulting from development of the recommended program. Recharge to the Guadalupe - San Antonio River Basin portion of the Edwards Aquifer would be increased by approximately 20 percent under average conditions and 16 percent under drought conditions with the implementation of the recommended recharge enhancement program.

Table 3.2-1 Summary of Recommended Recharge Enhancement Program for Guadalupe-San Antonio River Basin								
Rank*	Project	Capacity (acft)	Surface Area (ac)	Annual Cost (\$)	Average Conditions		Drought Conditions	
					Recharge Enhancement (acft/yr)	Cost/Unit Recharge Enhancement (\$/acft/yr)	Recharge Enhanceme nt (acft/yr)	Cost/Unit Recharge Enhancement (\$/acft/yr)
1	Cibolo Creek	10,000	476	1,165,724	9,733	120	1,485	785
2	Lower Blanco	50,000	1,408	6,830,020	49,766	137	22,490	304
3	San Geronimo	<u>3,500</u>	<u>183</u>	<u>475,476</u>	<u>3,128</u>	152	<u>645</u>	737
	Total	63,500	2,067	8,471,220	62,627		24,620	
	Average					135		344

\*Rank is based on cost/unit recharge enhancement for average conditions.

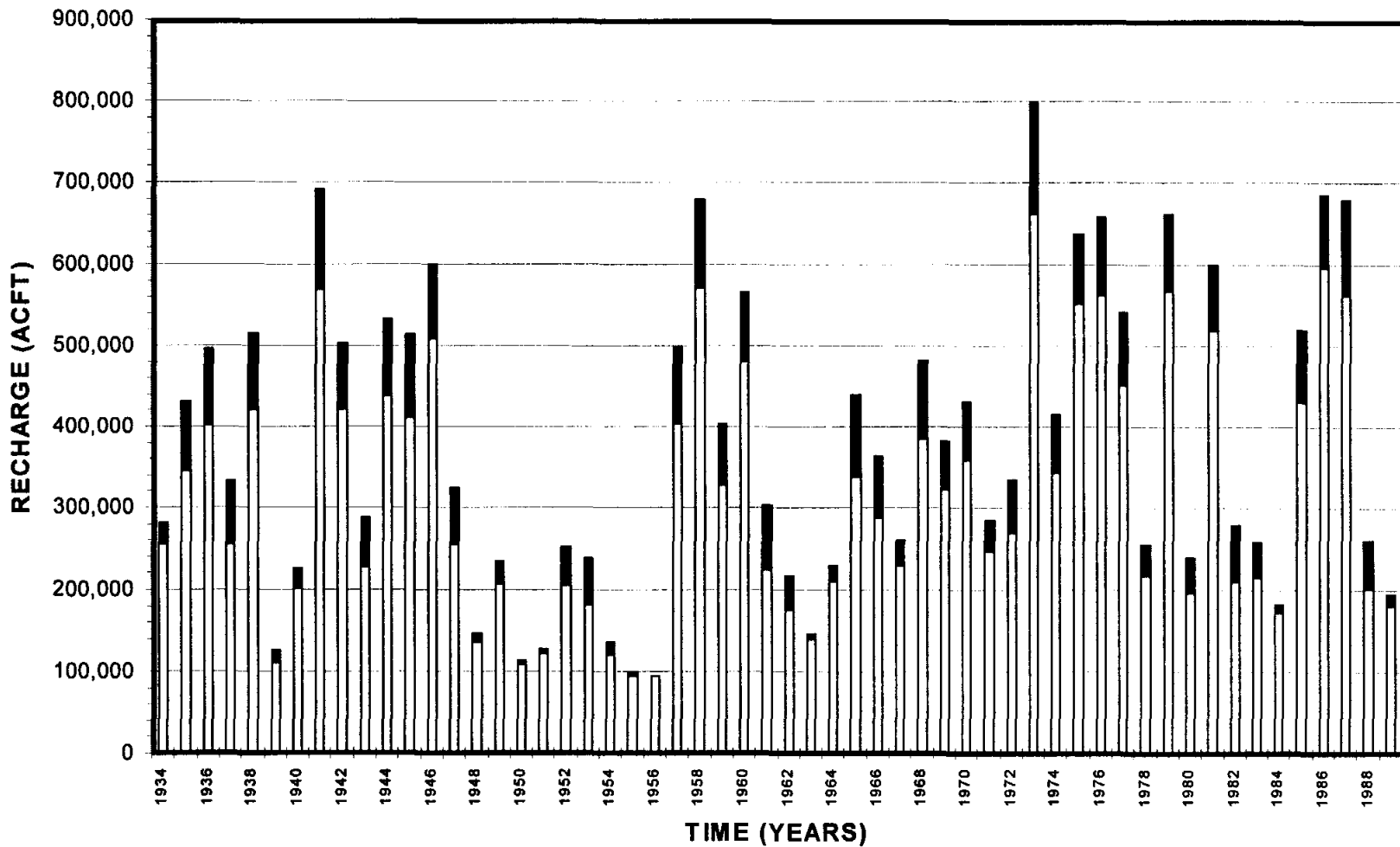

NATURAL RECHARGE       RECHARGE ENHANCEMENT W/ RECOMMENDED PROGRAM

TRANS TEXAS WATER PROGRAM /  
WEST CENTRAL STUDY AREA

EDWARDS AQUIFER RECHARGE  
GUADALUPE-SAN ANTONIO  
RIVER BASIN



HDR Engineering, Inc.

FIGURE 3.2-1

GUADALUPE - SAN ANTONIO RIVER BASIN  
RECHARGE ENHANCEMENT STUDY  
FEASIBILITY ASSESSMENT

Cumulative downstream impacts associated with the program are represented by changes in streamflow at the Saltwater Barrier, as presented in Figure 3.2-2. Based on the minimal reduction in estuarine inflow, potential impacts to fisheries harvest, salinity fluctuations, and nutrient/sediment loadings are likely to be insignificant as a result of development of the recommended recharge enhancement program in the Guadalupe - San Antonio River Basin. Long-term average annual streamflows at the Saltwater Barrier would decrease approximately 2.5 percent from 1,625,115 acft/yr without recharge enhancement to 1,585,088 acft/yr with the three recommended projects. This represents a maximum upper limit of impact, since enhanced springflows resulting from the additional recharge will reduce these impacts. Median monthly flow changes with the projects range from a maximum decrease due to the projects of 4,855 acft per month (7 percent) in April to a minimum decrease of 272 acft per month (0.3 percent) in June.

### **3.3 Combined Program for Nueces and Guadalupe - San Antonio River Basins (L-18A)**

A recharge enhancement study for the Nueces River Basin was completed by the EUWD in June, 1994.<sup>2</sup> The recommended recharge enhancement program resulting from that study consisted of four projects, each constructed at its optimum size. These projects included, from east to west, the Lower Verde, Hondo, Sabinal, and Frio Projects. As discussed in Section 3.1 for the Cibolo Creek and Bexar/Medina County projects in the Guadalupe — San Antonio Basin, the recharge projects in the Nueces River Basin could be enlarged to obtain additional flood control benefits and/or to facilitate recharge of imported water. For comparison purposes in this study, capital costs for the recommended Nueces River Basin projects were updated from mid-1994 to the first quarter 1996 level using U.S. Bureau of Reclamation Construction Cost Indices (USBR CCI) for earth or concrete dams (as appropriate) and for secondary road relocations. Land acquisition costs were held constant and environmental mitigation costs were inflated by seven percent over the 21-month period. Total capital costs were annualized using an interest rate of eight percent for 25 years. The total capital cost of the Nueces River Basin

---

<sup>2</sup> HDR Engineering, Inc., "Nueces River Basin Edwards Aquifer Recharge Enhancement Project, Phase IVA," Edwards Underground Water District, June, 1994.

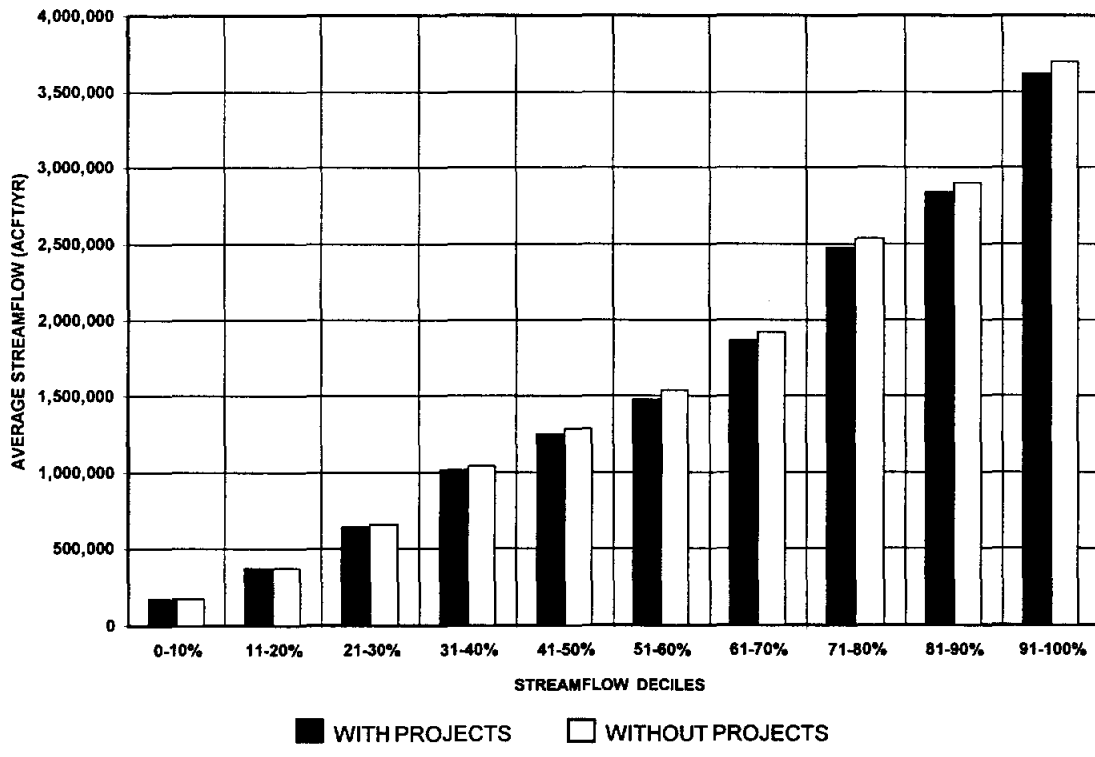
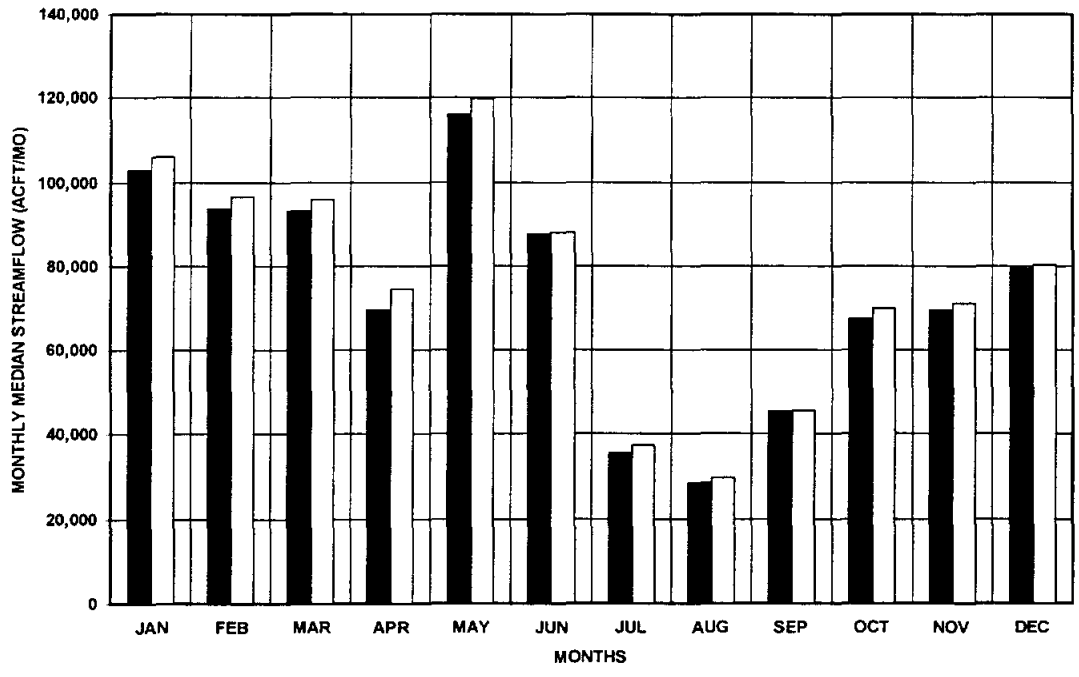

GUADALUPE - SAN ANTONIO RIVER BASIN  
 RECHARGE ENHANCEMENT STUDY  
 FEASIBILITY ASSESSMENT

TRANS TEXAS WATER PROGRAM /  
 WEST CENTRAL STUDY AREA

**RECHARGE ENHANCEMENT PROGRAM  
 CHANGES IN STREAMFLOW  
 AT SALT WATER BARRIER**



HDR Engineering, Inc.

FIGURE 3.2-2

recharge enhancement program is estimated to be \$60.0 million and the total annual cost for this program would be about \$7.0 million.

A summary of the recommended recharge enhancement program for the Nueces River Basin is presented in Table 3.3-1. Development of this program would provide 45,135 acft/yr of recharge enhancement under average conditions at an average unit cost of \$156/acft/yr (\$0.48 per 1,000 gallons). Recharge enhancement under drought conditions would be 9,250 acft/yr at an average unit cost of \$760/acft/yr (\$2.33 per 1,000 gallons). Costs to mitigate impacts to the Choke Canyon Reservoir / Lake Corpus Christi System yield and reductions in fresh water inflows to the Nueces Estuary were included in the development of project costs.

A combined recharge enhancement program for the Edwards Aquifer has been developed by ranking the recommended projects in the Nueces and Guadalupe - San Antonio River Basins based on the unit cost of recharge enhancement under average conditions. The combined recharge enhancement program is presented in Table 3.3-2. Graphical presentations of this program are shown in Figures 3.3-1 and 3.3-2. Development of this combined program could provide 107,762 acft/yr of recharge enhancement under average conditions at an average unit cost of \$144/acft/yr (\$0.44 per 1,000 gallons). Recharge enhancement under drought conditions would be 33,870 acft/yr at an average unit cost of \$458/acft/yr (\$1.41 per 1,000 gallons). The total capital cost of the combined Edwards Aquifer recharge enhancement program is estimated to be \$141.8 million and the total annual cost for this program would be about \$15.5 million.

As shown in Table 3.3-2, the Lower Blanco project represents a significant portion of the recharge enhancement under both long-term and drought average conditions. The calculation of potential recharge enhancement and, therefore, the unit cost of enhancement is a function of the natural percolation rate used for the recharge pool in the model. Detailed geologic and hydrogeologic investigations of the Lower Blanco reservoir area will be necessary to determine natural and expected recharge rates and the subsequent movement of ground water from the site. A similar conclusion was reached for the proposed Indian Creek project on the Nueces River in the 1994 Nueces River Basin recharge enhancement study.

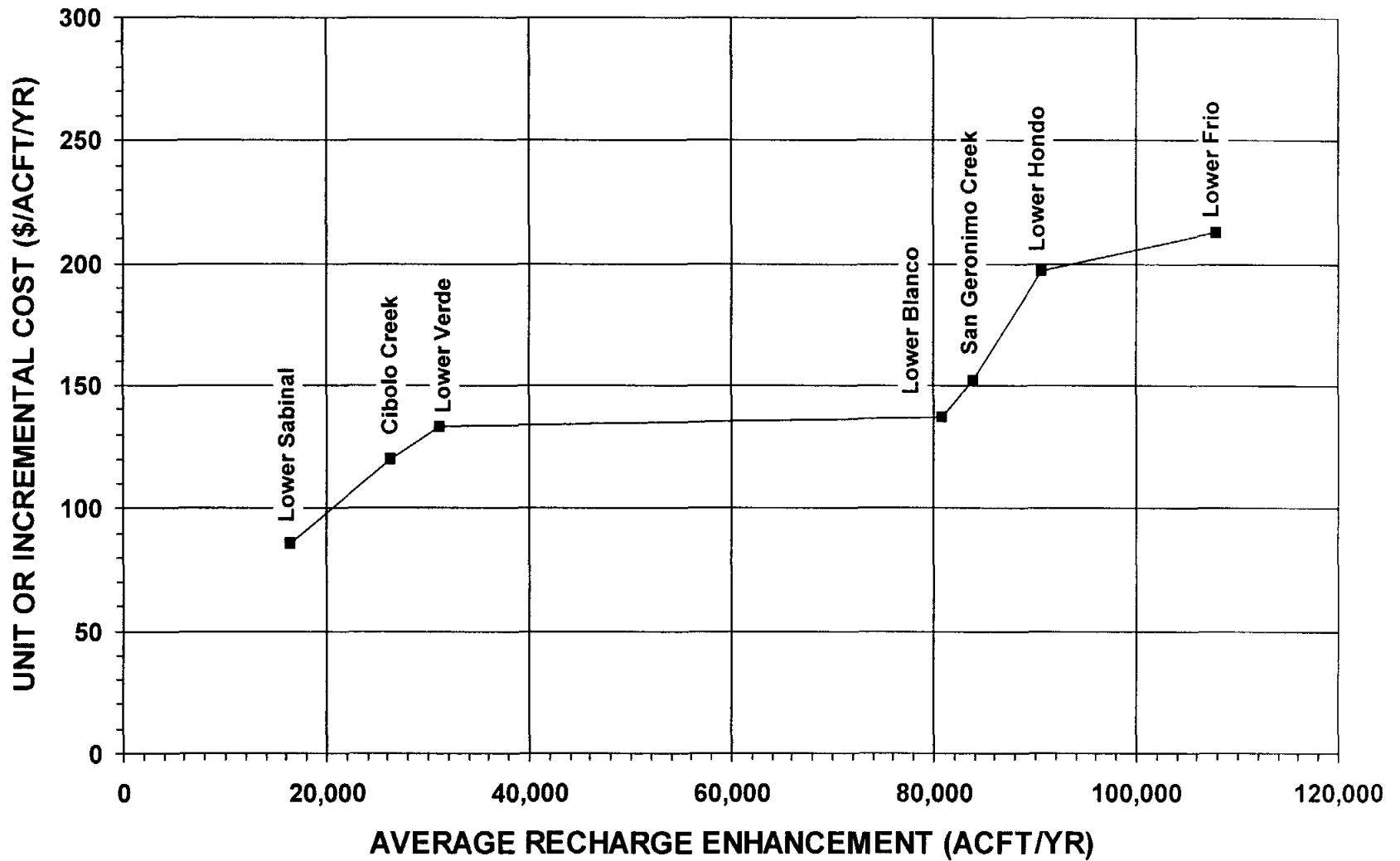

Table 3.3-1 Summary of Recharge Enhancement Program for Nueces River Basin								
Rank*	Project	Capacity (acft)	Surface Area (ac)	Annual Cost (\$)	Average Conditions		Drought Conditions	
					Recharge Enhancement (acft/yr)	Cost/Unit Recharge Enhancement (\$/acft/yr)	Recharge Enhancement (acft/yr)	Cost/Unit Recharge Enhancement (\$/acft/yr)
1	Lower Sabinal	8,750	454	1,420,829	16,442	86	2,358	603
2	Lower Verde	3,600	334	647,148	4,850	133	1,719	376
3	Lower Hondo	2,800	232	1,335,515	6,779	197	1,193	1,119
4	Lower Frio	<u>17,500</u>	<u>1,099</u>	<u>3,628,170</u>	<u>17,064</u>	213	<u>3,980</u>	912
	Total	32,650	2,119	7,031,662	45,135		9,250	
	Average					156		760

\*Rank is based on cost/unit recharge enhancement for average conditions.

Table 3.3-2 Combined Recharge Enhancement Program for Edwards Aquifer								
Rank*	Project	Capacity (acft)	Surface Area (ac)	Annual Cost (\$)	Average Conditions		Drought Conditions	
					Recharge Enhancement (acft/yr)	Cost/Unit Recharge Enhancement (\$/acft/yr)	Recharge Enhancement (acft/yr)	Cost/Unit Recharge Enhancement (\$/acft/yr)
1	Lower Sabinal	8,750	454	1,420,829	16,442	86	2,358	603
2	Cibolo Creek	10,000	476	1,165,724	9,733	120	1,485	785
3	Lower Verde	3,600	334	647,148	4,850	133	1,719	376
4	Lower Blanco	50,000	1,408	6,830,020	49,766	137	22,490	304
5	San Geronimo	3,500	183	475,476	3,128	152	645	737
6	Lower Hondo	2,800	232	1,335,515	6,779	197	1,193	1,119
7	Lower Frio	<u>17,500</u>	<u>1,099</u>	<u>3,628,170</u>	<u>17,064</u>	213	<u>3,980</u>	912
	Total	96,150	4,186	15,502,882	107,762		33,870	
	Average					144		458

\*Rank is based on cost/unit recharge enhancement for average conditions.



TRANS TEXAS WATER PROGRAM /  
WEST CENTRAL STUDY AREA

**RECHARGE ENHANCEMENT  
PROGRAM FOR COMBINED  
BASINS - COST SUMMARY**



HDR Engineering, Inc.

FIGURE 3.3-1

Development of the Lower Blanco recharge project would likely result in sustained increases in flow from San Marcos Springs. These additional flows could be recaptured from the Guadalupe River below the San Marcos River confluence and diverted back to the Edwards Aquifer via a pipeline to the recharge zone. Conceptual studies on springflow recirculation (Alternatives L-22 and L-23) indicate that water diverted below Comal and or San Marcos Springs and introduced to the aquifer in northern Bexar County significantly benefits Comal Springs discharge thereby allowing more sustained pumpage during drought. Transferring water further west into Medina and/or Uvalde Counties could further elevate long-term storage levels in the aquifer, also increasing reliability of both pumpage and springflows during drought. Implementation of the recharge enhancement projects identified in this study is a key component in the overall management of the Edwards Aquifer.

To fully evaluate the potential benefits of implementing the recommended recharge program, it is recommended that the TWDB's GWSIM4 Model be used to evaluate the effects on increased aquifer pumpage and/or springflows. A systematic incremental analysis in which the enhanced recharge volumes produced by each recharge structure are incorporated into the groundwater model would clearly demonstrate the beneficial effects of each structure on aquifer pumpage and/or springflows. Additionally, this analysis should consider the combined benefits of implementing the recommended recharge program in combination with springflow recirculation.

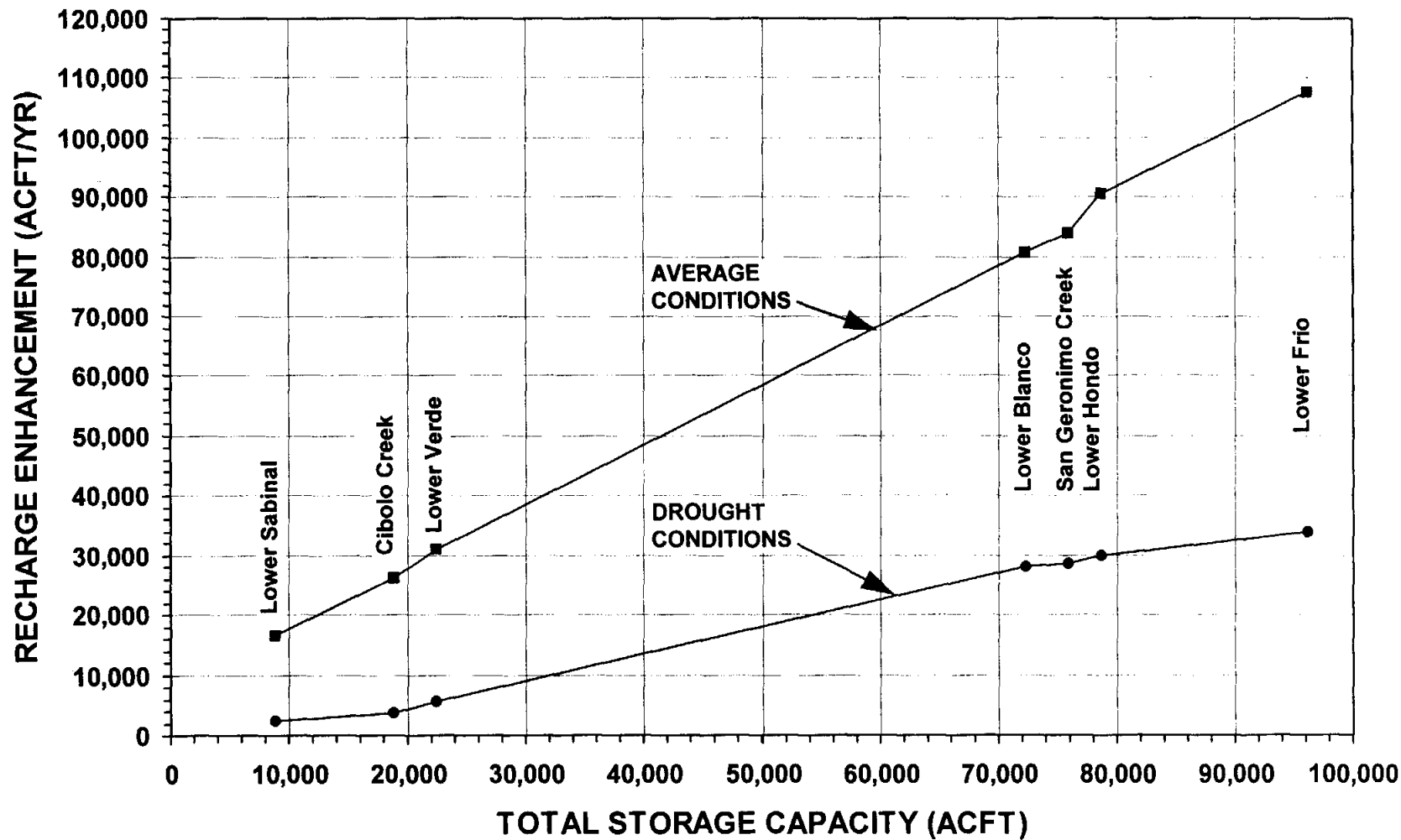

TRANS TEXAS WATER PROGRAM /  
WEST CENTRAL STUDY AREA

**RECHARGE ENHANCEMENT  
PROGRAM FOR COMBINED  
BASINS - STORAGE SUMMARY**

FIGURE 3.3-2



**APPENDIX A**

**RECHARGE PROJECT EVALUATION METHODOLOGY**

**APPENDIX A**

**RECHARGE PROJECT EVALUATION METHODOLOGY**

**APPENDIX A  
RECHARGE PROJECT EVALUATION METHODOLOGY**

**TABLE OF CONTENTS**

<b>Section</b>	<b>Page</b>
<b>A.1 Site Reconnaissance</b> .....	A.1-1
<b>A.2 Recharge Enhancement Hydrology</b> .....	A.2-1
A.2.1 Guadalupe - San Antonio Basin Model .....	A.2-1
A.2.2 Recharge Enhancement Computation Methodology .....	A.2-5
A.2.3 Recharge Reservoir Operations .....	A.2-10
A.2.4 Water Rights Considerations .....	A.2-12
A.2.5 Recharge Rate Curves.....	A.2-12
A.2.6 Environmental Flow Criteria .....	A.2-17
<b>A.3 Flood Hydrology</b> .....	A.3-1
A.3.1 History of Flooding.....	A.3-3
A.3.2 Flood Hydrology Model .....	A.3-4
A.3.3 Historical Flood Calibrations.....	A.3-8
A.3.4 Model Development.....	A.3-15
A.3.5 Model Results .....	A.3-17
<b>A.4 Project Feasibility Designs and Cost Estimates</b> .....	A.4-1
A.4.1 Dam, Spillway, and Appurtenant Works .....	A.4-1
A.4.2 Road Relocations .....	A.4-11
A.4.3 Land Acquisition.....	A.4-11
A.4.4 Environmental Mitigation.....	A.4-12
A.4.5 Downstream Impacts Mitigation.....	A.4-13
A.4.6 Miscellaneous Project Costs .....	A.4-13



## LIST OF FIGURES

<b>Figure No.</b>		<b>Page</b>
A.1-1	Location of Potential Recharge Enhancement Projects .....	A.1-2
A.2-1	River Basin Model Flowchart .....	A.2-4
A.2-2	Typical Gaged Watershed With Recharge Enhancement Project .....	A.2-7
A.2-3	Recharge Reservoir Contents Simulation .....	A.2-11
A.2-4	Recharge Rate Curves for Potential Projects .....	A.2-13
A.2-5	Comparison of Computed and Observed Recharge Rates at Existing Recharge Projects.....	A.2-16
A.3-1	Historical Flood Calibration Watersheds .....	A.3-10
A.3-2	Representative Observed and Computed Hydrographs .....	A.3-12
A.3-3	Regional Lag Time Relationship .....	A.3-14
A.4-1	Embankment Dam Profile.....	A.4-2
A.4-2	Embankment Dam Section .....	A.4-3
A.4-3	Composite Dam Profile.....	A.4-4
A.4-4	RCC Gravity Dam Section.....	A.4-5
A.4-5	RCC Gravity Dam Profile.....	A.4-6
A.4-6	RCC Channel Dam Profile.....	A.4-7
A.4-7	RCC Channel Dam Section .....	A.4-8

## LIST OF TABLES

<b>Table No.</b>		<b>Page</b>
A.2-1	Summary of Streamflow Losses Across the Recharge Zone .....	A.2-9
A.2-2	Summary of Instream Flow Passage Requirements Used in Environmental Assessments for Cibolo Project .....	A.2-18
A.2-3	Summary of Flow Statistics Used in Environmental Assessments of Upper and Lower Blanco Projects .....	A.2-20
A.2-4	Summary of Instream Flow Passage Requirements Used in Environmental Assessments for Upper Blanco Project .....	A.2-21
A.2-5	Summary of Instream Flow Passage Requirements Used in Environmental Assessments for Lower Blanco Project.....	A.2-22
A.3-1	TNRCC Hydrologic Criteria for Dams.....	A.3-2
A.3-2	Flood History Summary.....	A.3-5
A.3-3	Design Storm Summary.....	A.3-16
A.3-4	Summary of Flood Hydrology Model Parameters.....	A.3-18
A.3-5	Flood Hydrology Summary .....	A.3-19
A.4-1	Unit Cost Data.....	A.4-10
A.4-2	Land Prices.....	A.4-12

(This page intentionally left blank)

## APPENDIX A

### RECHARGE PROJECT EVALUATION METHODOLOGY



Key components of this study include site-specific evaluations of recharge characteristics, development of comprehensive flood hydrology, an initial assessment of environmental characteristics, and a visual assessment of the site geology and construction material availability for the four major potential recharge enhancement projects. These include Cibolo Creek, Lower Blanco, Upper Blanco, and San Geronimo Creek Projects. A program of five smaller potential recharge enhancement projects in the Leon/Helotes/Government Canyon watersheds in Northern Bexar and Medina Counties were studied as a group. The locations of these projects are shown in Figure A.1-1. The following subsections summarize the physical considerations and the technical methodologies applied to estimate recharge enhancement, develop flood hydrology models, and determine the related costs of dam and spillway construction, road relocations, land acquisition, water rights mitigation, environmental mitigation, permitting, and engineering.

#### **A.1 Site Reconnaissance**

Two site reconnaissance trips were conducted during the course of the study to gather key data. An initial site reconnaissance was conducted in August, 1994, at potential smaller recharge enhancement projects in the Leon/Helotes/Government Canyon watersheds. San Geronimo Creek, Cibolo Creek, and Upper Blanco. Participants in the August, 1994, site reconnaissance included HDR staff, EUWD staff, Greg Rothe (Project Coordinator for the EUWD at the time), and Paul Price of Paul Price Associates (PPA). This site reconnaissance was fast-paced, with the primary objective being to screen and identify up to six potential smaller projects in the Leon/Helotes/Government Canyon watersheds for inclusion in the recharge enhancement study.

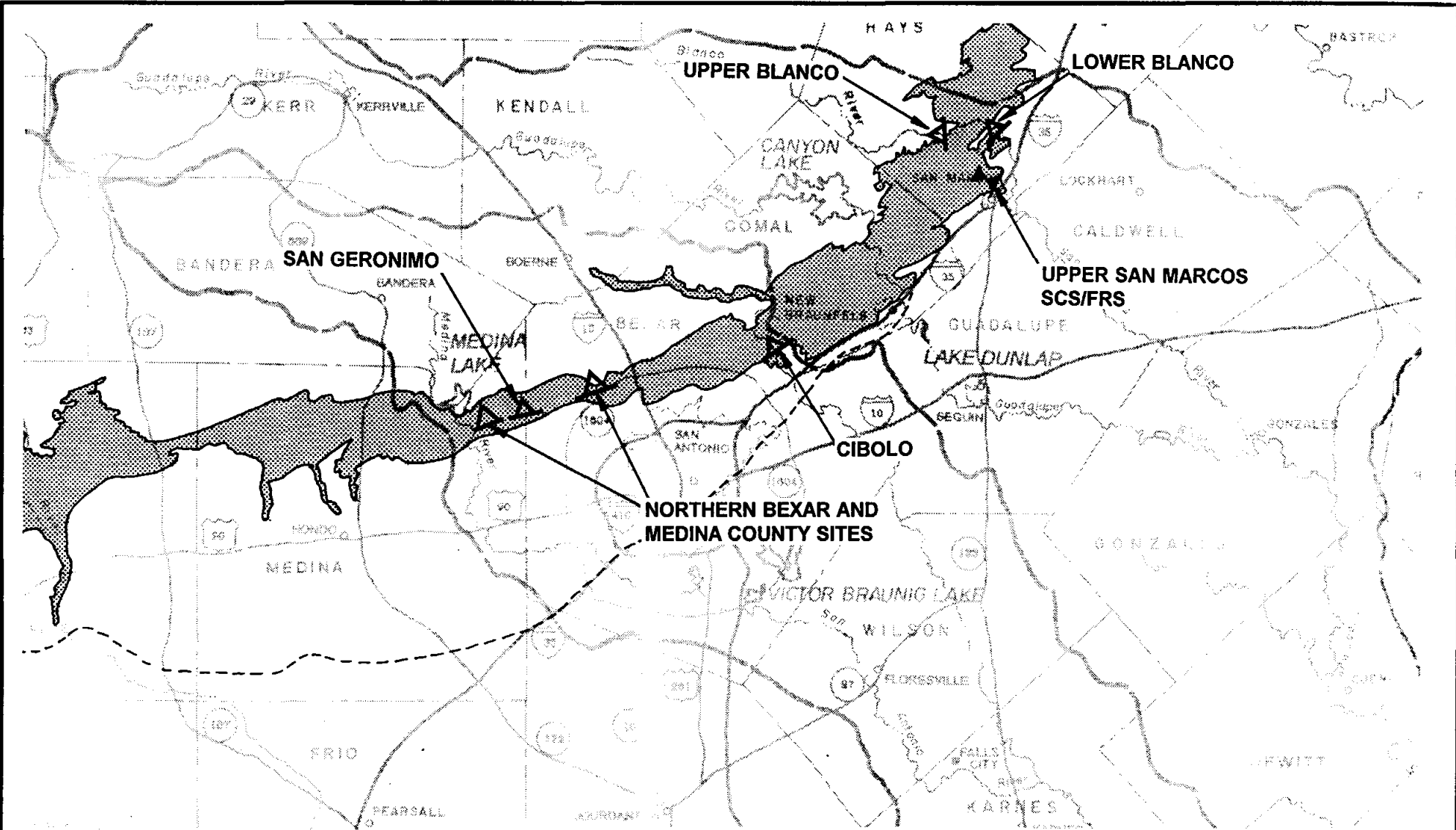
A second and more detailed site reconnaissance was conducted at Cibolo Creek, Upper Blanco, and San Geronimo Creek in October, 1994. It is important to note that landowner permission to access the Lower Blanco project site was never obtained and, therefore, a reconnaissance of this site by the project team has not been performed. Participants in the October, 1994, site reconnaissance included HDR staff, EUWD staff, Greg Rothe, and subconsultants to HDR, including Fugro-McClelland (Southwest), Inc. (F-M). LBG-Guyton



-  PROPOSED RECHARGE PROJECT(S)
-  EXISTING SCS/FRS RESERVOIRS

TRANS TEXAS WATER PROGRAM /  
WEST CENTRAL STUDY AREA

**LOCATION OF POTENTIAL  
RECHARGE ENHANCEMENT  
PROJECTS**

FIGURE A.1-1

GUADALUPE - SAN ANTONIO RIVER BASIN  
RECHARGE ENHANCEMENT STUDY  
FEASIBILITY ASSESSMENT



HDR Engineering, Inc.

Associates (LBG), United Aerial Mapping (IAM), and Paul Price Associates (PPA). Each project team member served a key role during the site reconnaissance and for the study as follows:

<u>Team Member</u>	<u>Role</u>
HDR Engineering, Inc.	Hydrology and Dam Design
Fugro-McClelland (SW), Inc.	Site Geology and Geotechnical Engineering
LBG-Guyton Associates	Geohydrology
United Aerial Mapping	Surveying
Paul Price Associates	Environmental Assessment

HDR's primary objectives during the site reconnaissance were to gather information concerning the dam site and upstream watershed for each project. Working in conjunction with F-M and their geologic subconsultant (Dr. Charles Woodruff, Jr.), HDR selected potential dam and spillway alignments, assisted with the development of geotechnical considerations for design, and scouted potential sources of locally available construction materials at each project. Additionally, HDR staff examined the upstream watershed characteristics to facilitate developing parameters for flood hydrology modeling.

The primary objectives of F-M and Dr. Woodruff during the site visits were to conduct a geologic "fatal flaw" assessment for construction of a dam and spillway, develop geotechnical considerations for project design, assist with selection of dam and spillway alignments, and delineate locally available construction materials. Although the geology at each site examined is complex, no fatal geologic or geotechnical flaws were evident during the site reconnaissance that would prohibit development of the proposed recharge projects.<sup>1</sup>

During the site reconnaissance, LBG staff examined the streambed and reservoir areas of the Cibolo Creek, Upper Blanco, and San Geronimo projects. The purpose of this work was to develop: 1) an understanding of geohydrologic conditions which affect and control ground water movement at each site; 2) a basis for comparative evaluation of sites with respect to potential for recharge; and 3) a ranking of the sites in terms of their relative recharge potential. LBG developed a numerical rating system, called the Hydrogeologic Setting Index (HSI), to compare the relative recharge potential of each major site. The HSI is used as a composite description of

---

<sup>1</sup> Fugro-McClelland (Southwest), Inc., "Geotechnical Consultation - Recharge Enhancement Study, Phase II Guadalupe - San Antonio River Basin, December 23, 1997.

eight key geologic and hydrogeologic factors which are believed to affect and control recharge to the Edwards Aquifer. A matrix of these factors and the computed HSI for each of the four major projects is provided in a report prepared by LBG which is included in Appendix C.

UAM participated in the site reconnaissance to stake the dam centerline and become familiarized with property restrictions, access locations, and the physical conditions at each site. Following the site visits, UAM performed ground control surveying and aerial photographic mapping to develop a dam centerline profile for each major site (except Lower Blanco) which was used to more accurately compute dam and spillway construction quantities. Dam centerline profiles for the Lower Blanco site and the group of five smaller projects in Northern Bexar and Medina Counties were obtained from USGS 7.5 minute topographic maps.

PPA participated in the site reconnaissance to assess various environmental features and identify any "fatal" (or very expensive) environmental issues. Environmental features examined include land uses, recreational activity, habitat types and values, cultural resources potential, wetland occurrences, and evidence of karstic features. Research on site specific information concerning the presence, or potential presence, of threatened and endangered species was also conducted by PPA. Environmental concerns that may constitute a fatal flaw and prohibit development of the proposed recharge projects were not evident during the site visits, although development of either of the Blanco River projects is anticipated to be a very difficult and expensive process. Specific potential environmental impacts and mitigation requirements are discussed in a report prepared by PPA which is included in Appendix B.

## **A.2 Recharge Enhancement Hydrology**

### **A.2.1 Guadalupe - San Antonio Basin Model**

The original computer model of the Guadalupe - San Antonio River Basin (GSA River Basin Model) and the associated input databases were developed as a part of the Guadalupe - San Antonio River Basin Recharge Enhancement Study<sup>2</sup> completed in 1993 and sponsored by the Edwards Underground Water District (EUWD). It was created specifically to evaluate recharge enhancement projects with respect to potential impacts on water availability downstream and employs a monthly time step proceeding with flow calculations in an upstream to downstream order simulating recharge, channel losses, spring flows, water rights, and reservoir operations at 38 control points for a 56-year (1934 to 1989) period of record. The original basin model was capable of simulating the complex operations of Canyon Lake including the release of water for hydropower, downstream senior water rights, and downstream wholesale water customers.

In the performance of the Guadalupe - San Antonio River Basin Recharge Enhancement Study, the GSA River Basin Model was used to determine recharge enhancement under average and drought conditions associated with the implementation of each of eight potential projects. Of the eight original projects evaluated, six of the projects involved the construction of major new facilities. These projects included:

- Cibolo Dam No. 1 on Cibolo Creek near Selma.
- Lower Blanco project on the Blanco River near Kyle.
- Cloptin Crossing project on the Blanco River near Wimberley.
- Enlargement of the existing San Geronimo Creek Recharge Dam and/or development of additional storage upstream.
- Development of a program of small Soil Conservation Service/Flood Retarding Structures (SCS/FRS) in the Leon, Helotes, and Government Creek watersheds similar to that in the Salado Creek watershed.
- One additional SCS/FRS in the Dry Comal Creek watershed.

---

<sup>2</sup> HDR Engineering, Inc. (HDR), "Guadalupe - San Antonio River Basin Recharge Enhancement Study," Vols. 1, 2, and 3, Edwards Underground Water District, September, 1993.



In addition to these six, two projects were investigated which would not involve extensive construction of new facilities. Those projects were:

- Acquisition of irrigation rights at Medina and Diversion Lakes for diversion and injection to the Edwards Aquifer.
- Modification or closure of SCS/FRS outlets in the Salado Creek, Dry Comal Creek, and upper San Marcos River watersheds.

Five of the original eight potential recharge enhancement projects were carried forward for further analysis in this phase of the Trans-Texas Water Program. These five projects include:

- Cibolo Dam No. 1;
- Lower Blanco;
- Upper Blanco (replaces Cloptin Crossing);
- San Geronimo Creek; and
- Leon/Helotes/Government Creek watersheds (program of up to five smaller projects).

Although the model version used in the original studies was adequate for comparison of the relative merits of potential projects over a range of recharge pool capacities, the accuracy of recharge enhancement and downstream impact estimates was limited by the following assumptions:

- 1) Projects were simulated at identified control points and/or streamflow gage sites;
- 2) Project inflow and storage were evaluated on a monthly timestep;
- 3) Streamflows impounded in Type 2 (direct percolation) projects were assumed to recharge within one month;
- 4) Net evaporation from Type 2 recharge reservoirs was neglected; and
- 5) Outlet conduits at recharge enhancement projects were assumed to be capable of passing any amount of water theoretically required.

Accuracy of recharge enhancement and downstream impact estimates is believed to have improved significantly in the current study as a result of the synthesis of new methodologies and incorporation of the following modifications to the river basin models:

- 1) Projects are simulated at actual sites located between existing control points.
- 2) A daily computational timestep is employed to more accurately simulate recharge at and below the proposed projects. Using a daily timestep, the simultaneous occurrence of inflow and recharge at the proposed projects can be simulated, accounting for the incremental recharge. In the previous version of the basin model, any monthly inflow in excess of the recharge pool volume would have been spilled without having an opportunity to contribute to recharge.
- 3) Measured channel loss rates across the Edwards Aquifer recharge zone<sup>3,4,5</sup> are used in the computation of natural and enhanced recharge.
- 4) Recharge rate curves based on the previously cited measured channel loss rates, soil permeability characteristics,<sup>6,7,8</sup> and depth to the water table, which were calibrated to observations at the Parkers Creek and Middle Verde recharge projects, are used to evaluate daily recharge as a function of average storage.
- 5) Daily net evaporation from each recharge reservoir is computed as a function of average storage.
- 6) Passage of water for mitigation of impacts to downstream water rights is based on outlet characteristics and daily average storage.

The derivation and application of these methodologies and model modifications are described in the following subsections.

Computation of daily recharge at each of the proposed projects while minimizing adverse impacts on downstream water availability is accomplished in the GSA River Basin Model using the three-pass process presented in Figure A.2-1. In the first pass, recharge without the new project is computed, monthly flows are simulated at all control points, and any shortages or failures to satisfy downstream diversion rights are tabulated. In the second pass, the new project is included and any downstream shortages are tabulated assuming full impoundment and/or diversion of inflows considering recharge and evaporation on a daily timestep at the new project.

---

<sup>3</sup> Espey, Huston & Associates, Inc. (EH&A), "Feasibility Study of Recharge Facilities on Cibolo Creek," Draft Report for Edwards Underground Water District, October, 1982.

<sup>4</sup> U.S. Geological Survey (USGS), "Guadalupe and Blanco Rivers, Texas, Seepage Investigations," in cooperation with the Texas State Board of Water Engineers, Open File Report No. 52, October 1955.

<sup>5</sup> USGS, "Streamflow Losses Along the Balcones Fault Zone, Nueces River Basin, Texas," Water-Resources Investigations Report 83-4368, Austin, Texas, 1983.

<sup>6</sup> Soil Conservation Service (SCS), "Soil Survey of Bexar County, Texas," USDA, Reissued, June, 1991.

<sup>7</sup> SCS, "Soil Survey of Comal and Hays Counties, Texas," USDA, June, 1984.

<sup>8</sup> SCS, "Soil Survey of Medina County, Texas," USDA, August, 1977.

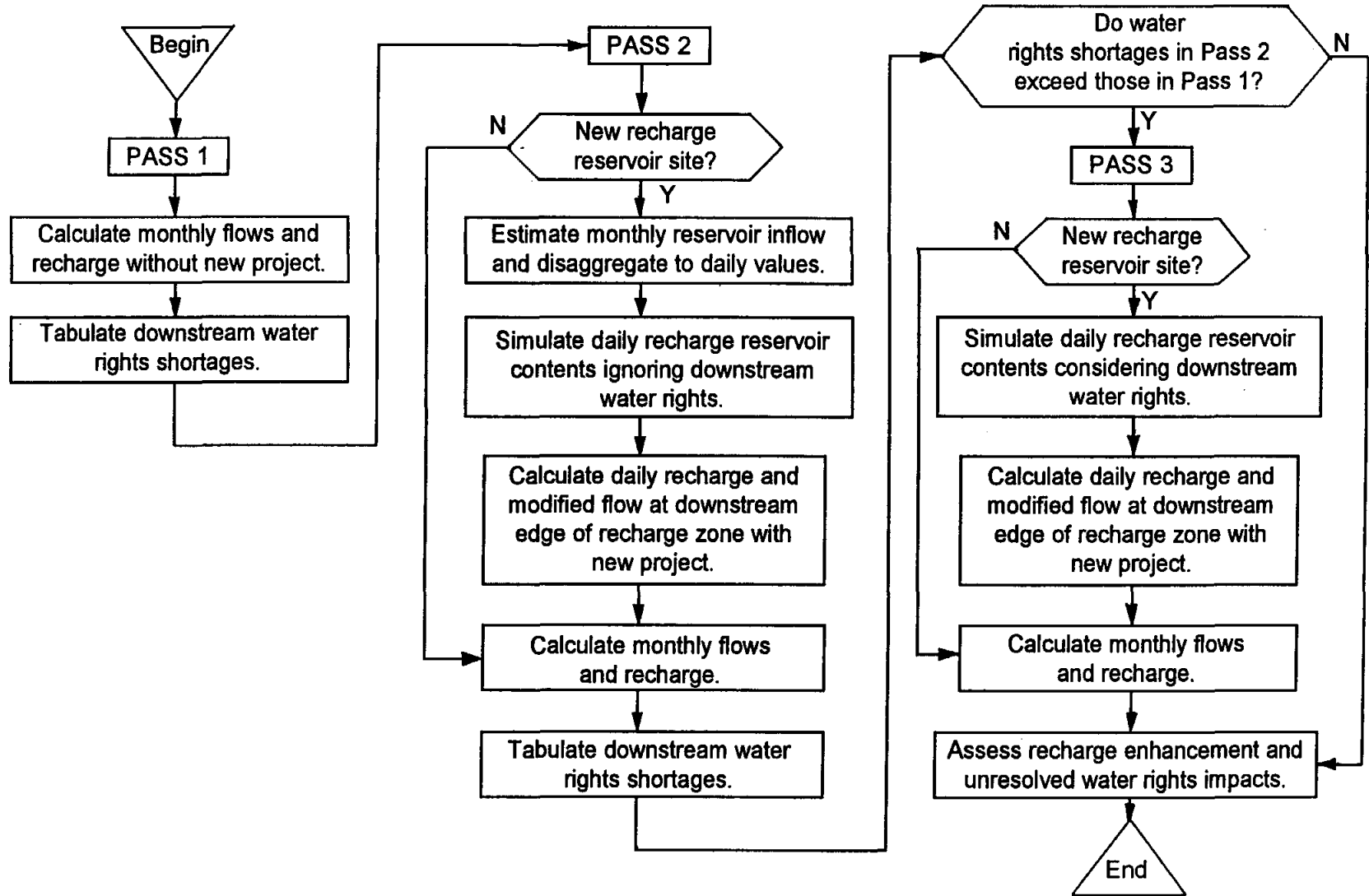

TRANS TEXAS WATER PROGRAM /  
WEST CENTRAL STUDY AREA

**RIVER BASIN MODEL  
FLOWCHART**



If shortages in the second pass exceed those in the first pass, the monthly flow volume required to eliminate the additional shortages is computed for the next control point below the new project. In the third and final pass, recharge, evaporation, and water rights releases at the new project are computed on a daily basis and modified monthly flows are simulated at all control points. The change in flows at the Saltwater Barrier on the Guadalupe River are tabulated and used to indicate potential impacts of the proposed projects on freshwater inflows to the Guadalupe Estuary.

In order to quantify the recharge enhancement of these potential recharge projects, the Guadalupe - San Antonio (GSA) River Basin Model<sup>9</sup> was modified to simulate the four major projects on a daily timestep. In addition to these modifications, the following assumptions were made regarding the operation of the GSA River Basin Model.

- 400,000 acft/yr Edwards Aquifer pumpage;
- Full water rights use;
- No Applewhite Reservoir;
- 47,000 acft/yr yield of Canyon Lake (600 cfs hydro); and
- CP&L 300 cfs water right at Victoria honored.

These assumptions are consistent with previous studies performed in the region and provided for a consistent basis of comparison for all the projects analyzed and discussed in Section 2.0.

#### A.2.2 Recharge Enhancement Computation Methodology

An improved methodology employing a daily computational timestep for the estimation of monthly Edwards Aquifer recharge enhancement associated with proposed projects was developed in the Nueces River Basin Edwards Aquifer Recharge Enhancement Project, Phase IVA<sup>10</sup> and used in this study. The daily timestep was applied in the simulation of both recharge reservoir contents and delivery of spills and releases to the next downstream control point located near the downstream edge of the recharge zone. The procedure applied for recharge

---

<sup>9</sup> HDR, op. cit., September, 1993.

<sup>10</sup> HDR, "Nueces River Basin, Edwards Aquifer Recharge Enhancement Project - Phase IVA," Edwards Underground Water District, June, 1994.

enhancement computation using the GSA River Basin Model is outlined in the following paragraphs. A typical gaged watershed, including a proposed project is shown in Figure A.2-2.

Recharge enhancement is defined as the difference between recharge with and without a new project. Hence, the first step in the computation of enhanced recharge is the estimation of baseline monthly recharge without the proposed project. As described in previous reports,<sup>11,12</sup> monthly recharge in a typical gaged watershed traversing the recharge zone may be estimated using the following equation:

$$R_0 = Q_1 + QI - Q_2$$

where:

- $R_0$  = Recharge without project;
- $Q_1$  = Flow at upstream control point;
- $QI$  = Potential intervening runoff; and
- $Q_2$  = Flow at downstream control point.

Flows at the upstream and downstream control points reflect adjustments for monthly water rights diversions. With knowledge of the baseline recharge, as well as the portions of the intervening area and the typical instream loss rates both upstream and downstream of the project, monthly inflow to the Type 2 (direct percolation) projects is estimated using the following equation:

$$QD = Q_2 - QI \left( \frac{A_C}{(A_B + A_C)} \right) + R_0 \left( \frac{L_C}{(L_B + L_C)} \right)$$

where:

- $QD$  = Monthly project inflow;
- $A_C$  = Intervening area downstream of project;
- $A_B$  = Intervening area upstream of project;
- $L_C$  = Loss rate for reach downstream of project; and
- $L_B$  = Loss rate for reach upstream of project.

As is apparent in this equation, potential runoff is prorated above and below the project based on subwatershed area, while baseline recharge is prorated based on measured instream loss rates since the majority of recharge occurs through the bed and banks of the stream.

---

<sup>11</sup> HDR, "Nueces River Basin Regional Water Supply Planning Study-Phase I," Vols. 1, 2, and 3, Nueces River Authority, May, 1991.

<sup>12</sup> HDR, op. cit., September, 1993.

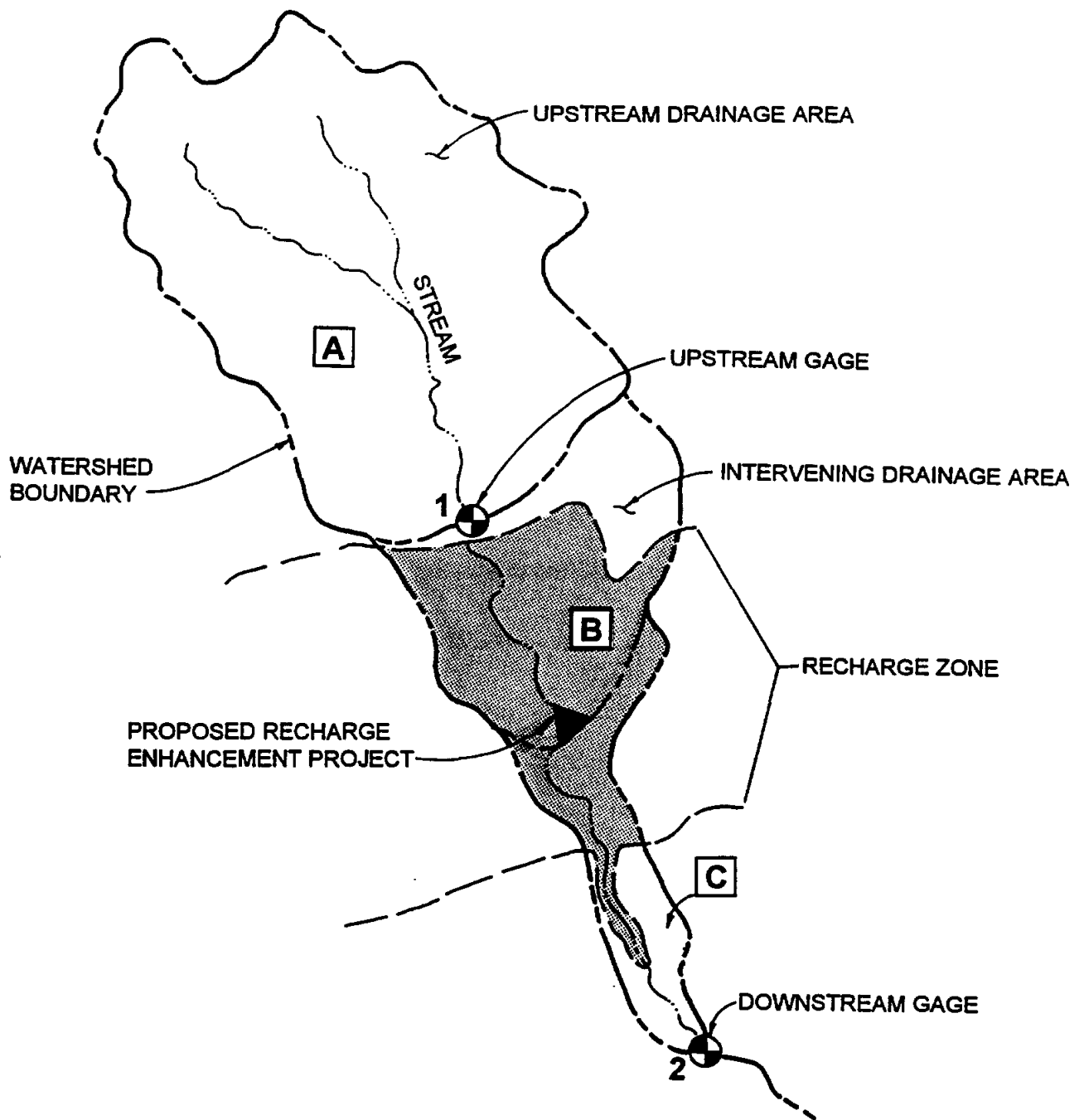

GUADALUPE - SAN ANTONIO RIVER BASIN  
 RECHARGE ENHANCEMENT STUDY  
 FEASIBILITY ASSESSMENT



HDR Engineering, Inc.

TRANS TEXAS WATER PROGRAM /  
 WEST CENTRAL STUDY AREA

TYPICAL GAGED WATERSHED WITH  
 RECHARGE ENHANCEMENT PROJECT

FIGURE A.2-2

Monthly inflow to the Type 1 (catch and release) project analyzed in this study was estimated using a slightly different equation:

$$QD = Q_1 + QI \left( \frac{A_B}{(A_B + A_C)} \right)$$

This equation demonstrates that for Type 1 projects none of the recharge occurs upstream of the project. Therefore, the potential runoff at the project site is the flow that passes the upstream gage plus the prorated intervening runoff that occurs below the gage and above the project. This proration is based on a drainage area ratio of the total intervening potential flow.

In the first applications of this methodology in the Nueces River Basin,<sup>13</sup> detailed low-flow channel loss measurement studies<sup>14</sup> performed for the creeks and rivers intersecting the Edwards Aquifer Recharge Zone were critical in the development of the methodology. In the Guadalupe - San Antonio River Basin, however, no such consistent data is available. Therefore, the channel loss rates for the projects studied in this analysis were derived from a number of sources. Table A.2-1 summarizes the channel loss data used in this study.

Monthly estimates of project inflow were disaggregated to daily values using available gaged streamflow records in the watershed of interest or, if necessary, in an adjacent watershed by one of the following procedures, listed in order of preference:

- 1) Daily project inflows based on the daily percentage of gaged monthly streamflow as recorded at the next downstream control point identified with the number 2 in Figure A.2-2.
- 2) Daily project inflows based on the daily percentage of the sum of gaged daily streamflows as recorded at the next upstream control point identified with the number 1 in Figure A.2-2, which are in excess of the loss rate for the reach upstream of the project.
- 3) Obtain an estimate of daily streamflow at the next downstream control point based on the daily percentage of gaged monthly streamflow in the nearest adjacent watershed.

Importation of water to a recharge reservoir can be considered simply by adding imported flows to the daily inflows originating in the local watershed.

---

<sup>13</sup> HDR, op. cit., June, 1994.

<sup>14</sup> USGS, op. cit., 1983.

<b>Table A.2-1</b>		
<b>Summary of Streamflow Losses Across the Recharge Zone</b>		
<b>Potential Project</b>	<b>Channel Loss Rate (cfs/mile)</b>	<b>Information Source</b>
Upper and Lower Blanco River	2.1	Stream loss analysis using USGS streamflow gage records for Gage No. 08171000 (Blanco River at Wimberley, TX.) and Gage No. 08171300 (Blanco River near Kyle, TX.). Results consistent with previous USGS low flow study. <sup>1</sup>
Cibolo Creek	6.0 <sup>2</sup> 1.2	EH&A, "Feasibility Study of Recharge Facilities on Cibolo Creek," Draft Report for Edwards Underground Water District, October 1982.
San Geronimo Creek	9.9	No actual channel loss measurement data available. Site assumed to be similar to Verde Creek in Nueces River Basin and used average channel loss in the vicinity of the proposed Lower Verde Creek Project. <sup>3</sup>
<b>Notes:</b>		
<sup>1</sup> USGS, "Guadalupe and Blanco Rivers, Texas, Seepage Investigations," in cooperation with the Texas State Board of Water Engineers, Open File Report No. 52, October 1955.		
<sup>2</sup> EH&A report indicates that part of the Cibolo Creek reach over the recharge zone appears to be gaining. Therefore in this analysis, the gaining reaches were considered to be negligible and stream loss rates were computed for two reaches: Reach 1 - the USGS streamflow gage at Boerne to the FM 1863 crossing was found to have an average loss rate of 1.2 cfs/mile; and Reach 2 - the confluence of Clear Fork, West Fork and Cibolo Creek to the USGS streamflow gage at Selma was found to have an average loss rate of 6.0 cfs/mile.		
<sup>3</sup> USGS, "Streamflow Losses Along the Balcones Fault Zone, Nueces River Basin, Texas." Water-Resources Investigations Report 83-4368, Austin, Texas, 1983.		

Using the daily project inflow estimates, recharge reservoir contents are simulated in accordance with the methodology detailed in Section A.2.3. Daily recharge through direct percolation is based on project-specific relationships between recharge rate and average reservoir storage (expressed in terms of inundated surface area) presented in Section A.2.5. Diversion from the proposed project for recharge, such as those from the Blanco River projects to the upper San Marcos River, are user-specified.

Total monthly recharge with the proposed project is computed using the following equation:

$$R = \left[ Q_1 + QI \left( \frac{A_B}{(A_B + A_C)} \right) - QD \right] + \sum RD_i + \sum D_i + \sum RC_i$$

where:

- R = Monthly recharge with project;
- $\sum RD_i$  = Sum of daily recharge estimates of direct percolation from project;
- $\sum D_i$  = Sum of daily recharge estimates of diversion from project; and
- $\sum RC_i$  = Sum of daily recharge estimates downstream of project.



Note that the first term in this equation is essentially the natural monthly recharge occurring upstream of the project, while the remaining terms are affected either directly ( $\Sigma RD_t$ ,  $\Sigma D_t$ ) or indirectly ( $\Sigma RC_t$ ) by reservoir storage.

The recharge computation methodology and its incorporation in the GSA River Basin Model was verified in part by performance of simulations assuming zero project storage capacity, in which case  $\Sigma RD_t$  and  $\Sigma D_t$  became zero and recharge with the "project" (R) was essentially equal to recharge without the project ( $R_0$ ). Further verification of all model simulation capabilities was accomplished through extensive manual checking of intermediate computations and final output summaries.

### A.2.3 Recharge Reservoir Operations

Simulation of recharge reservoir operations in the GSA River Basin Model is governed by the integral equation of continuity,<sup>15</sup> as expressed in Figure A.2-3, in which the various volume fluxes affecting storage are identified. A simultaneous solution for these fluxes is necessary to obtain an accurate estimate of end-of-day storage, as recharge, net evaporation, and water rights releases are dependent upon the water surface area or elevation associated with the average storage ( $\bar{S}$ ) for a given day. This solution is obtained in the basin model using the Half-Interval Method,<sup>16</sup> the application of which to reservoir contents simulation is described in detail in previous studies.<sup>17</sup>

Monthly net evaporation rates used in this study for the 1940-89 period were calculated from TWDB quadrangle data<sup>18</sup> using a standard inverse distance ratio procedure to convert values typical of the centroids of adjacent quadrangles to values representative of a specific reservoir site. Net evaporation rates for the 1934 to 1939 period were computed from available pan evaporation records<sup>19</sup> adjusted by pan coefficients recommended by the TWDB<sup>20</sup> and by coincident measured precipitation. Daily estimates of net evaporation were obtained by dividing

---

<sup>15</sup> Chow, Ven Te, D.R. Maidment, and L.W. Mays, Applied Hydrology, McGraw-Hill Book Co., 1988.

<sup>16</sup> Carnahan, B. and Wilkes, J.O., Digital Computing and Numerical Methods, John Wiley and Sons, Inc., 1973.

<sup>17</sup> HDR, op. cit., September, 1993.

<sup>18</sup> Texas Water Development Board (TWDB), "Monthly Reservoir Evaporation Rates in Texas, 1940 through 1965," Report 64, October, 1967.

<sup>19</sup> TWDB, "Evaporation Data in Texas, Compilation Report, January 1907 - December 1970," Report 192, June, 1975.

<sup>20</sup> TWDB, op. cit., October, 1967.

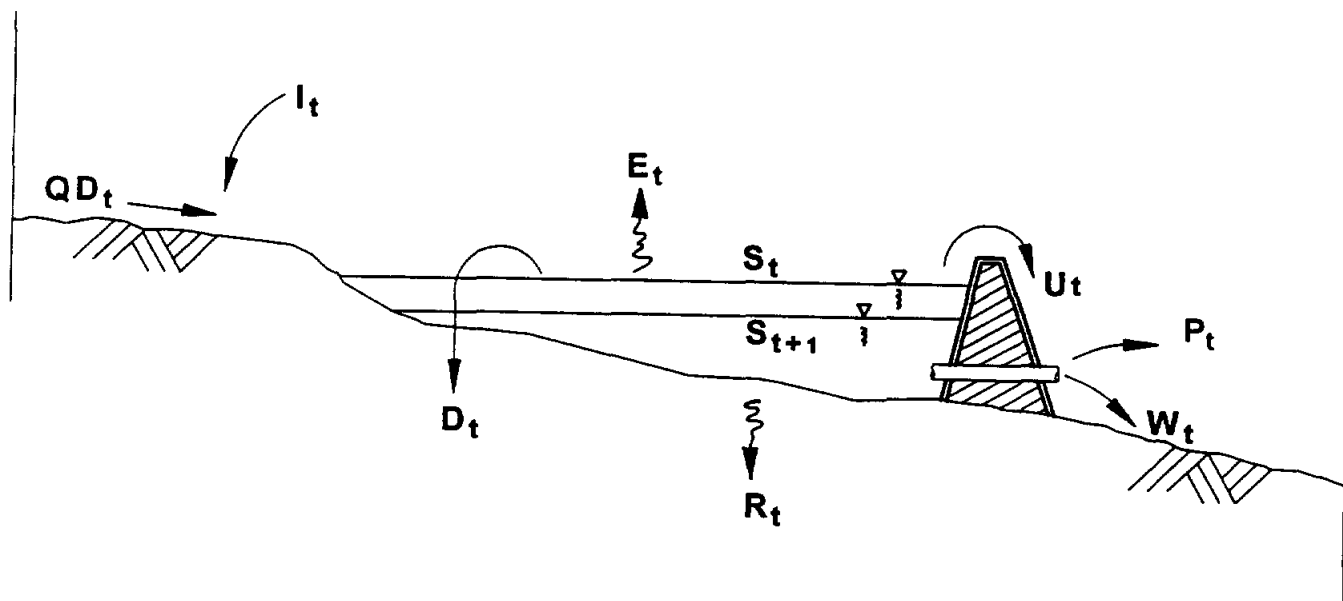

$$S_{t+1} = S_t + QD_t + I_t - E_t - R_t - D_t - W_t - U_t - P_t$$

- WHERE:
- |           |                              |   |
|-----------|------------------------------|---|
| $S_{t+1}$ | = END-OF-DAY STORAGE         | } $\bar{S} = \frac{S_t + S_{t+1}}{2}$         |
| $S_t$     | = BEGINNING-OF-DAY STORAGE   |   |
| $QD_t$    | = RESERVOIR INFLOW           | → COMPUTED                                    |
| $I_t$     | = IMPORTED INFLOW            | → USER SPECIFIED                              |
| $E_t$     | = NET EVAPORATION            | → $f(\bar{S}, \text{TWDB DATA})$              |
| $R_t$     | = DIRECT RECHARGE            | → $f(\bar{S}, \text{RECHARGE CURVE})$         |
| $D_t$     | = DIVERSION FOR RECHARGE     | → USER SPECIFIED                              |
| $W_t$     | = WATER RIGHTS RELEASE       | → $f(\bar{S}, \text{OUTLET CHARACTERISTICS})$ |
| $U_t$     | = SPILLS                     | → COMPUTED                                    |
| $P_t$     | = ENVIRONMENTAL PASS-THROUGH | → $f(QD_t, \text{CRITERIA})$                  |

\* THE HALF-INTERVAL METHOD WAS USED TO SOLVE FOR  $S_{t+1}$  USING  $E_t$ ,  $R_t$ ,  $P_t$  AND  $W_t$  BASED ON  $\bar{S}$ .

GUADALUPE - SAN ANTONIO RIVER BASIN  
RECHARGE ENHANCEMENT STUDY  
FEASIBILITY ASSESSMENT

**HDR**

HDR Engineering, Inc.

TRANS TEXAS WATER PROGRAM /  
WEST CENTRAL STUDY AREA

RECHARGE RESERVOIR  
CONTENTS SIMULATION

FIGURE A.2-3

the monthly rate by the number of days in the month, and multiplying by the surface area associated with average daily storage.

The relationship between water surface elevation, surface area, and storage capacity (E-A-C) was established for each project using a polar planimeter to measure surface area from successive elevation contours on available USGS 7.5-minute topographic maps. Storage volume calculations were generally performed using the average end area method.

#### A.2.4 Water Rights Considerations

In order to minimize the impact to existing senior water rights downstream of these potential projects, the outlet conduit at each recharge enhancement project was sized to pass the greater of the following: 1) Sufficient flow to traverse the remainder of the recharge zone, suffer downstream channel losses, and deliver peak monthly demand under water rights on the mainstem in 7 days with an average of 10 feet of head on the conduit; or 2) Sufficient flow to meet the monthly instream flow requirement in 30 days. Selected conduit sizes in this study ranged from a minimum of 48 inches in diameter at the Cibolo Creek and San Geronimo Creek projects to 60 inches in diameter at the Blanco River project sites. The GSA River Basin Model attempts to satisfy all of these run-of-the-river diversion rights to the extent they would have been satisfied without the proposed recharge enhancement project. In each month when additional shortages occur, a desired monthly flow volume is established for the next control point downstream of the project and daily releases dependent on reservoir stage and conduit size continue until the desired volume has been delivered, the reservoir drains completely, or the end of the month arrives.

#### A.2.5 Recharge Rate Curves

Recharge rate curves based on site-specific geologic characteristics were developed for the San Geronimo, Cibolo, and Lower Blanco projects. These curves relate an estimated direct percolation rate to the surface area associated with average daily storage in each recharge reservoir (see Figure A.2-4). The recharge rate curves provide a basis for computation of the daily recharge flux, which generally comprises the greatest portion of the water leaving the reservoir. The methodologies applied in the development and verification of these curves are

RECHARGE RATE FOR LOWER BLANCO SITE

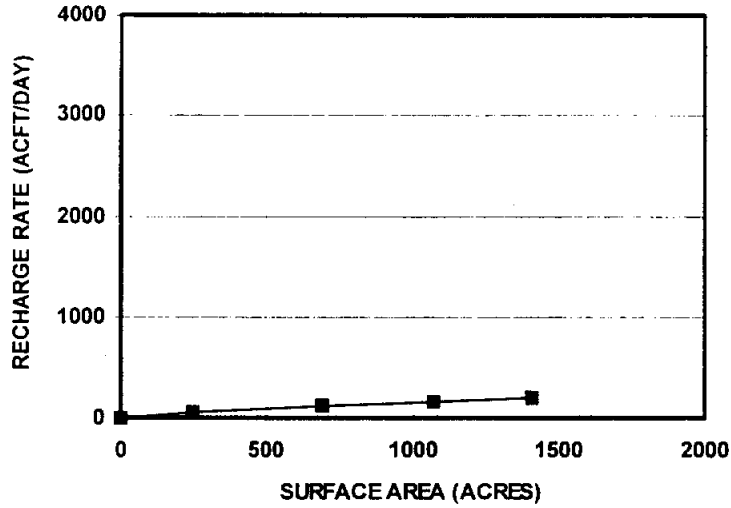

RECHARGE RATE FOR LOWER CIBOLO SITE

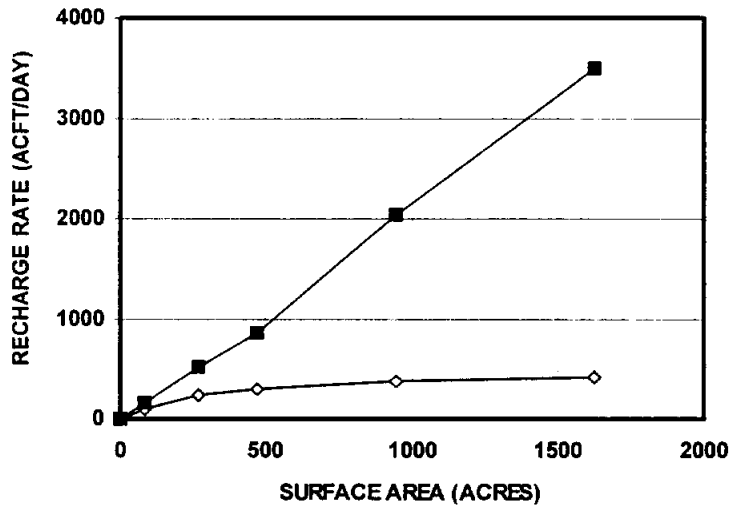

RECHARGE RATE FOR SAN GERONIMO SITE

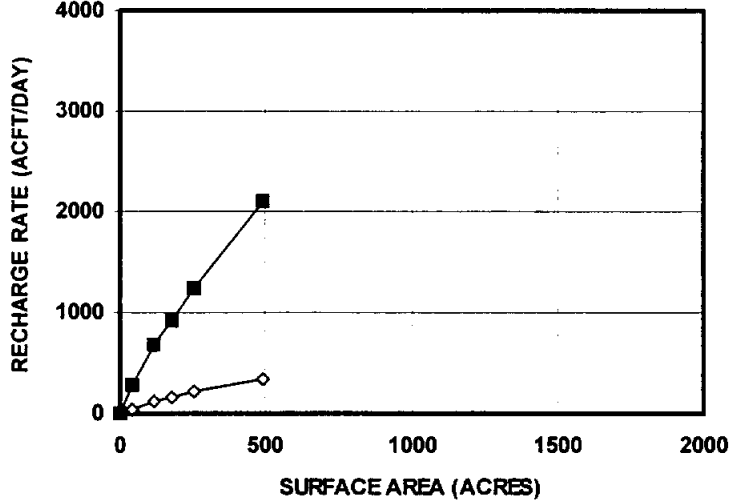

■ TOTAL RECHARGE    ◇ CHANNEL RECHARGE

GUADALUPE - SAN ANTONIO RIVER BASIN  
RECHARGE ENHANCEMENT STUDY  
FEASIBILITY ASSESSMENT



HDR Engineering, Inc.

TRANS TEXAS WATER PROGRAM /  
WEST CENTRAL STUDY AREA

RECHARGE RATE CURVES  
FOR POTENTIAL PROJECTS

FIGURE A.2-4

described in the following paragraphs and were developed as part of the Nueces River Basin, Phase IVA Study.<sup>21</sup>

The recharge rate curves are based on the sum of two assumed components of recharge which include that occurring in the main channel and that occurring in the periodically inundated overbank areas. As is apparent in Figure A.2-4, the overbank component dominates the estimated total daily recharge rate. The overbank recharge component for each project was derived from soil mapping and permeability rates published by the Soil Conservation Service.<sup>22,23,24</sup> Weighted average permeability rates for a range of recharge pool sizes at each project site were based on the average of the high and low published permeabilities and on the aerial concentration of mapped soil types.

The main channel component of the daily recharge rate was based on the assumption that the hydraulic characteristics of the fissures and solution cavities in the bed of the channel could be approximated by an orifice equation of the theoretical form:

$$Q = A\sqrt{2gH}$$

where:

- Q = Flow (cubic feet per second);
- A = Cross-sectional area of openings (square feet);
- g = Acceleration of gravity ( 32.2 feet per second squared); and
- H = Depth of water over the openings or head (feet).

Using this equation, an approximate area of openings in the channel bed (A) was computed based on average measured loss rates<sup>25,26</sup> for the stream reaches potentially inundated by the recharge reservoir, along with an assumed depth of flow coincident with these measurements. The main channel recharge rate was then computed for the range of recharge pool capacities using the area of openings and the average depth of water in the reservoir.

Calibration and/or verification of the overbank and main channel components of the recharge curves was accomplished in the Nueces River Basin Phase IVA Study<sup>27</sup> by preparation

---

<sup>21</sup> HDR, op. cit., June, 1994.

<sup>22</sup> SCS, op. cit., June, 1991.

<sup>23</sup> SCS, op. cit., June, 1984.

<sup>24</sup> SCS, op. cit., August, 1977.

<sup>25</sup> EH&A, op. cit., October, 1982.

<sup>26</sup> USGS, op. cit., 1983.

<sup>27</sup> HDR, op. cit., June, 1994.

of recharge rate curves for the existing Parkers Creek and Middle Verde Recharge Projects and comparing them to observed recharge rates at these projects. These comparisons are presented in Figure A.2-5. As reported in the previous study, the calculated recharge rate seems to correlate well with the observed recharge rate at the Parkers Creek Project, which lacks a defined channel and is assumed typical of overbank areas near the major streams on which the proposed recharge enhancement projects will be located. Due to variability in the soil permeability data, it was decided that average, rather than high, soil permeabilities would be used to develop the overbank component of the recharge rate curves. Calculated and observed recharge rates at the Middle Verde Project, the recharge pool of which is essentially confined to the main channel of Verde Creek, also correlate well and validate the application of a theoretical orifice equation. While comparisons with observed recharge rates tend to support the adopted recharge rate curve methodology, it is important to remember that the existing recharge projects are much smaller than the proposed projects.

The recharge rate curves for projects in the Guadalupe - San Antonio River Basin were reviewed by geohydrologists with LBG-Guyton and Associates, Inc. (LBG-Guyton) who supported their applicability at all sites with the exception of the Lower Blanco project (see Appendix C). LBG-Guyton's support was based, in part, on their assessment of hydraulic conductivity within the Edwards Aquifer near the existing and proposed recharge projects. This assessment concluded that recharge rates, in most cases, would more likely be controlled by soil cover and surface openings than by the ability of the Edwards formation to transmit water away from the point of recharge.

An alternative recharge rate curve was developed for the Lower Blanco project, however, because of the geohydrological assessment prepared by LBG-Guyton. The recharge rates in the Blanco River watershed are at times limited by near-surface water levels in the Edwards Aquifer and the close proximity of the San Marcos Springs. If large quantities of local recharge enhancement are applied to the aquifer in the region of the Lower Blanco project, it is believed that a large portion of this recharge will not percolate into the deep part of the aquifer, but will in fact "short circuit" the deep aquifer and discharge at San Marcos Springs rather quickly. Therefore, the recharge rate curve for the Lower Blanco project was based on local transmissivity of the aquifer, the depth to water in the region underlying the Blanco River, and an empirical

MIDDLE VERDE RECHARGE PROJECT

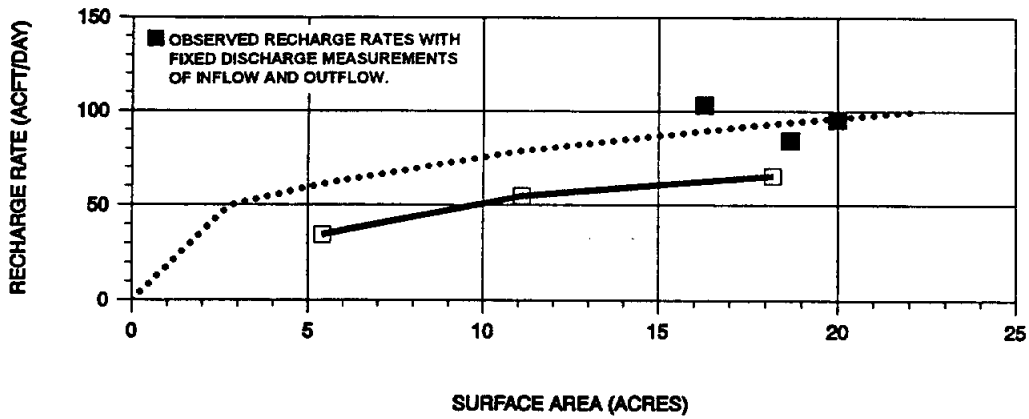

PARKERS CREEK RECHARGE PROJECT

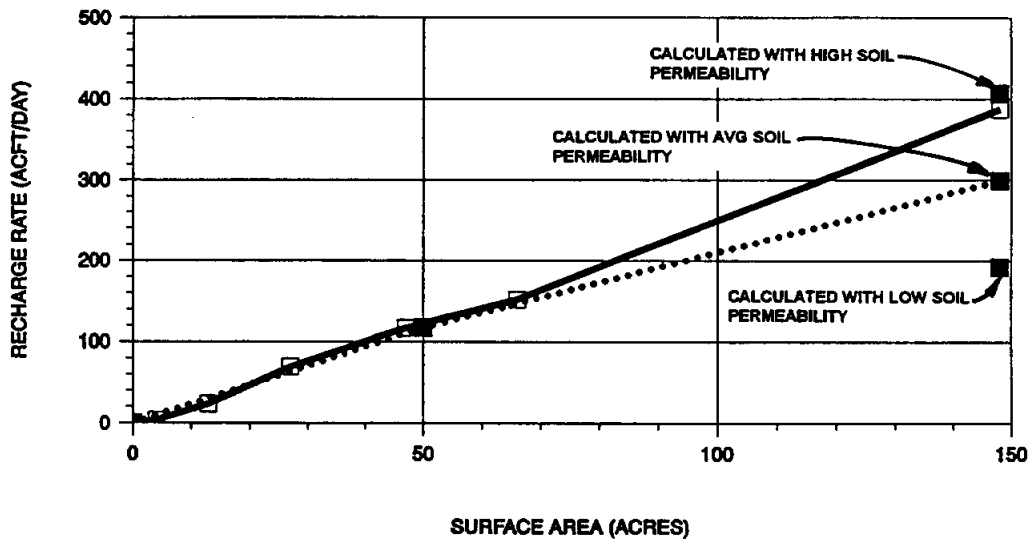

LEGEND

- OBSERVED RECHARGE RATE (ASSUMING NO INFLOW)
- CALCULATED RECHARGE RATE

GUADALUPE - SAN ANTONIO RIVER BASIN  
 RECHARGE ENHANCEMENT STUDY  
 FEASIBILITY ASSESSMENT



HDR Engineering, Inc.

TRANS TEXAS WATER PROGRAM /  
 WEST CENTRAL STUDY AREA

COMPARISON OF COMPUTED AND  
 OBSERVED RECHARGE RATES AT  
 EXISTING RECHARGE PROJECTS

FIGURE A.2-5

equation used in groundwater hydrology relating transmissivity to well production/injection capacity. The resulting recharge rate curve is considerably less than the one developed using the previously detailed methodology.

A recharge rate curve was not developed for the Upper Blanco project because it would be a Type 1 (catch and release) project and not located over the aquifer recharge zone. The smaller SCS/FRS type structures in the Leon, Helotes, and Government Creek watersheds were not modeled on a daily timestep, hence, recharge rate curves were not necessary for these structures.

#### A.2.6 Environmental Flow Criteria

In accordance with environmental strategies in place when this study was first initiated, the larger projects, Upper and Lower Blanco, Cibolo, and San Geronimo, were all evaluated with and without the original Trans-Texas Environmental Criteria. Under this criteria, whenever the project reservoir pools are at 60 percent of capacity or greater, at the beginning of the month, environmental flows must be passed through the project to protect the downstream riverine system. Inflows up to the mean monthly flow in April through June and August through October and inflows up to the monthly median in the remaining months of the year must be passed. When the reservoir is below 60 percent capacity, drought contingency measures are taken and the projects must pass inflows up to the median daily flow for the stream observed during the historical drought of record (assumed to be January, 1954 through December, 1956).

The Cibolo Creek project was evaluated with and without the aforementioned Trans-Texas Environmental Criteria for new reservoirs, and the associated streamflow statistics used in this criteria were computed using natural streamflows developed for the USGS Streamflow Gage on Cibolo Creek at Selma (08185000).<sup>28</sup> The pertinent monthly flow statistics are reported in Table A.2-2.

No environmental flow passage requirements were simulated for the San Geronimo Creek project because there are no gage data from which to compute the statistics. The flows

---

<sup>28</sup> HDR, *op. cit.*, September, 1993.



used in the GSA Basin Model for this watershed are estimated using rainfall runoff modeling techniques.

<b>Table A.2-2</b> <b>Summary of Instream Flow Passage Requirements</b> <b>Used in Environmental Assessments</b> <b>Cibolo Project</b>		
<b>Cibolo Creek at Selma, Texas<sup>1</sup></b>		
<b>Month</b>	<b>Normal Conditions Instream Flow Passage Requirement<sup>2</sup> (acft/month)</b>	<b>Drought Conditions Instream Flow Passage Requirement<sup>3</sup> (acft/month)</b>
January	0	0
February	0	0
March	0	0
April	1,110	0
May	2,654	0
June	3,139	0
July	0	0
August	249	0
September	1,184	0
October	921	0
November	0	0
December	0	0

<sup>1</sup> Based on natural flows for Cibolo Creek at Selma, Tx., USGS Gage No. 08185000, for 1934-89.  
<sup>2</sup> Based on the following flow statistics: monthly mean flows for April through June and August through October and monthly median flows for the remaining months.  
<sup>3</sup> Based on median flows for the drought of record (1954-56).

For the Blanco River projects, a slightly different approach was taken for environmental flow passage requirements due to the fact that the Blanco River, unlike most of the other creeks and rivers intersecting the Edwards Aquifer recharge zone, often times has enough flow to make it to the downstream limit of the recharge zone without going dry. Under the original Trans-Texas Environmental Criteria for new dams detailed above, drought flow passage requirements

would be equal to the drought median flow, which, for the Blanco River, is minimal. Therefore, in order to minimize the number of times the river downstream of the Upper and Lower Blanco projects dries up, an alternative environmental criteria was used for these projects.

The following is a summary of the environmental release rules used for the Blanco River projects. Under these rules, releases are triggered by the previous month flows at the USGS Streamflow Gage at Wimberley, TX (08171000), and environmental flow statistics are computed based the Wimberley gage. The rule is as follows:

1. If the flow passing the Wimberley gage in the previous month was greater than or equal to the historical 15<sup>th</sup>-percentile flow for the previous month and the project is not currently in Drought Mode, the project is considered to be in Normal Mode and will pass inflows up to the full instream flow requirement (40 or 60 percent of the median) for the current month.
2. If the flow passing the Wimberley gage in the previous month was less than the historical 15<sup>th</sup>-percentile flow for the previous month, the project is considered to be in Drought Mode and will pass inflows up to the drought median flow.
3. If the flow passing the Wimberley gage in the previous month was greater than the full instream flow requirement for the previous month (40 or 60 percent of the median) and the project is in Drought Mode, the project is considered to be in Normal Mode and will pass inflows as per Item 1 above.

Under these environmental release rules, a variety of flow statistics are needed for the historical flows at the Wimberley gage. The statistics used in this analysis were computed based on natural flow sets developed for the Guadalupe - San Antonio River Basin Model (GSA River Basin Model) during previous studies.<sup>29</sup> These statistics are summarized in Table A.2-3.

---

<sup>29</sup> HDR, op. cit., September, 1993.

**Table A.2-3**  
**Summary of Flow Statistics Used in Environmental Assessments**  
**of Upper and Lower Blanco Projects**

Month	Blanco River at Wimberley, Texas <sup>1</sup>		
	Monthly Median (acft)	Monthly 15 <sup>th</sup> -Percentile (acft)	Monthly Drought Median (acft)
January	3,408	908	571
February	3,458	1,150	571
March	4,410	1,090	571
April	6,373	1,558	571
May	7,408	1,453	571
June	5,690	1,281	571
July	3,622	861	571
August	2,510	697	571
September	2,863	784	571
October	3,788	856	571
November	3,028	869	571
December	3,450	948	571

<sup>1</sup> Based on natural flows for the Blanco River at Wimberley, Tx., USGS Gage No. 08171000, for 1934-89.

The streamflows at the Wimberley Gage were also used to determine the environmental flow passage minima at the Upper Blanco project for each month for both normal and drought conditions. These statistics are summarized in Table A.2-4.

<b>Table A.2-4</b>		
<b>Summary of Instream Flow Passage Requirements</b>		
<b>Used in Environmental Assessments</b>		
<b>Upper Blanco Project</b>		
	<b>Blanco River at Wimberley, Texas<sup>1</sup></b>	
<b>Month</b>	<b>Normal Conditions Instream Flow Passage Requirement <sup>2</sup> (acft/month)</b>	<b>Drought Conditions Instream Flow Passage Requirement <sup>3</sup> (acft/month)</b>
January	1,363	571
February	1,383	571
March	2,646	571
April	3,824	571
May	4,445	571
June	3,414	571
July	2,173	571
August	1,506	571
September	1,718	571
October	1,515	571
November	1,211	571
December	1,380	571

<sup>1</sup> Based on natural flows for Blanco River at Wimberley, Tx., USGS Gage No. 08171000, for 1934-89.  
<sup>2</sup> Based on the following flow statistics: 60 percent of monthly median flows for March through September and 40 percent of monthly median flows for the remaining months.  
<sup>3</sup> Based on median flows for the drought of record (1954-56).

The streamflows at the Kyle Gage were used to determine the environmental flow passage minima at the Lower Blanco project for each month for both normal and drought conditions. These statistics are summarized in Table A.2-5.

<b>Table A.2-5</b> <b>Summary of Instream Flow Release Requirements</b> <b>Used in Environmental Assessments</b> <b>Lower Blanco Project</b>		
	<b>Blanco River at Kyle, Texas<sup>1</sup></b>	
<b>Month</b>	<b>Normal Conditions Instream Flow Release Requirement<sup>2</sup> (acft/month)</b>	<b>Drought Conditions Instream Flow Release Requirement<sup>3</sup> (acft/month)</b>
January	985	0
February	1,112	0
March	1,933	0
April	3,265	0
May	4,255	0
June	2,981	0
July	1,586	0
August	805	0
September	1,141	0
October	966	0
November	834	0
December	1,175	0

<sup>1</sup> Based on natural flows for Blanco River at Kyle, Tx., USGS Gage No. 08171300, for 1934-89.

<sup>2</sup> Based on the following flow statistics: 60 percent of monthly median flows for March through September and 40 percent of monthly median flows for the remaining months.

<sup>3</sup> Based on median flows for the drought of record (1954-56).

### **A.3 Flood Hydrology**

Flood hydrology is the primary factor affecting the cost of many of the recharge enhancement projects as the results of the hydrologic analyses determine dam height and spillway size along with land acquisition and road relocation requirements. The Texas Natural Resource Conservation Commission (TNRCC) has promulgated dam design flood criteria, summarized in Table A.3-1, specifying the applicable percentage of the probable maximum flood (PMF) each structure must pass based on dam hazard potential and size classification. The PMF is defined as the flood that can be expected from the most severe combination of meteorological and hydrologic conditions that are reasonably possible in a region and was assumed to be the design flood event for the structures considered in this study. The PMF is commonly used in the design of projects such as dams and spillways for which virtually complete security from a flood induced failure is required.

The PMF is an extreme event. The magnitude of the PMF was computed for the recharge projects using storm events with 24-hour rainfall totals ranging as high as 35 inches, producing peak discharges that average about four times greater than any previously known event. Use of the PMF in the design of dams is principally based on risk. The potential for severe damage and loss of life due to a dam failure, along with the economic loss of the structure itself, dictate the criteria for a low level of risk in the design of dams and spillways. For structures with a design life of 100 years and sized to safely pass up to the 100-year return interval flood event, the risk of failure during the design life would be 63 percent, a rather high risk for a multi-million dollar structure with potential devastating impacts downstream. In order to achieve a risk of failure of 1 percent during the design life, the structure would be required to be designed for the 10,000 year return interval flood event. This highlights the fact that a low level of risk requires designing for a very rare and extreme event. Significant uncertainty exists in the estimation of even the 100-year return interval event using a gaged record of 40 to 50 years, thus any analysis of extreme events such as a 10,000 year flood would be extremely unreliable. Therefore, the PMF is commonly required as the design flood event in order to represent the physical upper limit of flood severity.

**Table A.3-1  
Texas Natural Resource Conservation Commission  
Hydrologic Criteria for Dams**

<b>Hazard Classification</b>	<b>Size Classification</b>	<b>Design Flood Event</b>
Low Hazard	Small Intermediate Large	¼ PMF ¼ PMF to ½ PMF PMF
Significant Hazard	Small Intermediate Large	¼ PMF to ½ PMF ½ PMF to PMF PMF
High Hazard	Small Intermediate Large	PMF PMF PMF

**Notes:**

**Hazard Classification:**

- Low hazard dams are defined as those dams where failure may damage farm buildings, limited agricultural improvements, and county roads. For low hazard dams, no loss of human life would be expected.
- Significant hazard dams are defined as those dams where failure would not be expected to cause loss of human life, but may cause damage to isolated homes, secondary highways, minor railroads, or cause interruption of service or use of relatively important public utilities.
- High hazard dams are defined as those dams where failure would be expected to cause loss of human life, extensive damage to agricultural, industrial, or commercial facilities, important public utilities, main highways, or railroads.

**Size Classification:**

- Small size dams are classified as those dams which have a total height less than 40 feet and have a total reservoir storage at top of dam of less than 1,000 acre-feet.
- Intermediate size dams are classified as those dams which have a total height between 40 feet and 100 feet and a total reservoir storage at top of dam between 1,000 acre-feet and 50,000 acre-feet.
- Large dams are classified as those dams which have a total height in excess of 100 feet and have a total reservoir storage at top of dam greater than 40,000 acre-feet.

### A.3.1 History of Flooding

Several major storm events have occurred in the region which have resulted in severe flooding for each of the streams considered in this study. Climate and physiography are the two primary contributing factors to the chronic floods that occur in the region.

The dominant physiographic element of the region is the Balcones Escarpment which separates the deeply dissected limestone terrain of the Edwards Plateau from the gently sloping, undulating clay and sand terrain of the Coastal Plain. Studies have shown that significant rainfall events occur as a result of convective thunderstorm activity and the movement of moisture-laden air along the established tropical Gulf storm tract.<sup>30</sup> These storms have produced some astonishing amounts of rainfall, including both national and world records for a given storm duration. The western edge of the Balcones fault zone is characterized by a relative steep, high escarpment at generally right angles to the direction of storm winds. The situation is ideal for lift-convective storms to produce heavy rainfall. This results from the moisture-laden air being lifted as it moves northward from the Gulf, and from thunderstorms being initiated where moist air is forced to rise.<sup>31</sup> One of the most spectacular cloudburst-type thunderstorms on record occurred on May 31, 1935, when a tongue of moist air protruded from the Gulf of Mexico to the vicinity of D'Hanis, Texas. The lift effect of this convectively unstable air at the Balcones Escarpment resulted in the production of 22 inches of rainfall in 2 hours 45 minutes.<sup>1</sup>

Weather disturbances of tropical origin have generated some of the greatest storms in Texas. The meteorology of such storms is characterized by easterly waves which pick up large quantities of moisture from passage over thousands of miles of warm tropical seas. As a result of weather conditions in the Caribbean, stable easterly waves are most likely to occur in the month of September. If an especially vigorous wave reaches the orographic barrier of the Balcones Escarpment, long-duration, heavy rains may result. This happened in the great Thrall, Texas storm (located northeast of the study area) of September 9–10, 1921, which produced locally 36.4 inches of rainfall in 18 hours and 38.2 inches of rainfall in 24 hours. This storm was

---

<sup>30</sup> Baker, Victor R., "Flood Hazards along the Balcones Escarpment in Central Texas, Alternative Approaches to their Recognition, Mapping, and Management", Bureau of Economic Geology, Geologic Circular 75-5, University of Texas at Austin, 1975.

<sup>31</sup> U.S. Dept. of Commerce, Weather Bureau, "The Climate of Central and Coastal Watersheds", Asheville, North Carolina, January, 1961.



considered to be the greatest of all continental United States rainstorms. Another example is the storm of September 9–10, 1952, which was the result of the near simultaneous arrival over Texas of a pressure surge from the northeast and the easterly wave trough. The warm easterly tropical air current decreased in stability while lifting over the Balcones Escarpment and ascended rain-cooled air that developed over the Edwards Plateau region. Storm totals of 20 to 26 inches were concentrated in small centers over the upper Pedernales and Guadalupe Rivers.

Flooding along the Edwards Aquifer recharge zone originating from the Edwards Plateau area is caused in part by the extreme storm events that occur in the area and also by physical characteristics of the drainage basins and stream channels. Very rapid runoff in the Edwards Plateau area is promoted by sparse scrub vegetation and bare limestone slopes. Steep slopes dominate the headwaters of the major streams which generate rapidly moving flood waves, producing significant flow depths. Some of the largest floods that have occurred in the streams in the study area have produced stages in excess of 30 feet to 40 feet. Table A.3-2 provides a summary of some of the largest floods that have occurred in the upper Guadalupe-San Antonio River Basin at selected gaging stations.

### A.3.2 Flood Hydrology Model

Dam height and spillway requirements are principally based on the volume and magnitude of the design flood event. The design flood event, which is most often the probable maximum flood event for large dams and high hazard dams, is determined using a computer model that simulates a watershed's response to precipitation. The HEC-1 Flood Hydrograph Package<sup>32</sup>, developed by the U.S. Army Corps of Engineers, was utilized to compute the design flood event at each dam site. The HEC-1 model is designed to simulate the surface runoff response of a watershed to precipitation by representing the watershed as a system of hydrologic and hydraulic components. Each component models an aspect of the precipitation-runoff process. Representation of a component involves specification of a set of parameters which describe the characteristics of the component and the mathematical relations which describe the physical process. The result is the computation of a streamflow hydrograph at each dam site.

---

<sup>32</sup> Hydrologic Engineering Center, "HEC-1 Flood Hydrograph Package", U.S. Army Corps of Engineers, Davis, CA, September, 1990.

**Table A.3-2  
Flood History Summary**

Gage Location	Gage Records Since <sup>1</sup>	Largest Flood for Period of Record <sup>2</sup>			Largest Flood Outside Period of Record <sup>3</sup>			Largest Flood Since <sup>4</sup>
		Peak Flow (cfs)	Peak Stage (ft)	Date	Peak Flow (cfs)	Peak Stage (ft)	Date	
<u>Blanco River</u> at Wimberley, 355 sq.mi.	1928	113,000	31.1	5/28/1929	N/A	25.0	7/1869	1869
near Kyle, 412 sq.mi.	1956	75,400	34.0	4/24/1957	139,000	40.0	5/28/1929	1882
<u>Johnson Creek</u> near Ingram, 114 sq.mi.	1960	95,900	24.3	10/14/1960	138,000	35.0	7/02/1932	1852
<u>Guadalupe River</u> at Hunt, 288 sq.mi.	1965	107,800	28.8	7/17/1987	206,000	36.6	7/2/1932	1900
at Kerrville, 510 sq.mi.	1986	141,000	37.7	7/17/1987	196,000	39.0	7/2/1932	N/A
at Comfort, 839 sq.mi.	1939	240,000	40.9	8/02/1978	N/A	42.3	7/1869	1848
<u>Cibolo Creek</u> at Boerne, 68.4 sq.mi.	1962	36,400	19.2	9/27/1964	25,600	16.3	9/10/1952	N/A
near Selma, 274 sq.mi.	1946	69,600	N/A	6/21/1997	N/A	26.0	1889	1869
<u>Medina River</u> at Bandera, 427 sq.mi.	1983	55,800	24.9	6/3/1987	N/A	46.2	8/02/1978	1880

Notes:

1. Published records based on an established USGS streamflow gaging station.
2. Largest flood since published records were available.
3. Largest flood known to have occurred outside of period of published record. Usually based on information from local residents.
4. Indicates the largest flood known, either during or outside of the period of record, is the largest flood to have occurred since at least this time.

Surface runoff is computed for the design flood event with the primary component being a precipitation hyetograph. Precipitation excess is computed by subtracting infiltration and surface detention losses based on a particular soil water infiltration rate function. Rainfall and infiltration are assumed to be uniform over the entire watershed being modeled. The resulting rainfall excesses are then routed using the unit hydrograph method to the downstream outlet of the watershed. A HEC-1 model for a single watershed can therefore be defined by four basic components. These are:

- 1) watershed area;
- 2) precipitation hyetograph;
- 3) precipitation losses; and
- 4) unit hydrograph routing parameters.

The watershed area is a known parameter that is determined based on available topographic mapping. The precipitation hyetograph, which is the primary component of the model, describes the volume and pattern of rainfall that occurs across the watershed for a particular storm event. The last two components, precipitation losses and unit hydrograph routing parameters, present the primary unknowns in the development of the rainfall-runoff model. Precipitation losses are determined in HEC-1 using a loss rate function. The loss rate function selected as the most appropriate for the watersheds considered in this study was the initial and uniform loss rate function, which is commonly used to represent the average precipitation losses for large watersheds. Precipitation losses are defined by two parameters in the initial and uniform loss rate function. The first parameter, the initial loss, represents the amount of rainfall that occurs before any runoff will begin. This term generally reflects the land surface interception of precipitation on vegetation, both trees and grass, and depression storage on the ground surface as water accumulates in hollows, cracks, and crevices or in any area where water is not free to move as overland flow. The second term, uniform loss rate, describes the infiltration of precipitation into the soil which is assumed to occur at a uniform rate over the duration of the storm event. In HEC-1, precipitation losses are assumed to be lost from the system and do not contribute to the runoff process.

The unit hydrograph method is the component in the rainfall-runoff model that transforms the rainfall excess into a surface runoff hydrograph. The unit hydrograph is a typical hydrograph

for a watershed. Since the physical characteristics of a watershed (i.e. shape, size, slope, etc.) are generally constant, it is expected that considerable similarity in the shape of runoff hydrographs from storms of similar rainfall characteristics would result. The unit hydrograph for a watershed is defined as a direct runoff hydrograph resulting from 1 inch of excess rainfall generated uniformly over the drainage area at a constant rate for an effective duration.<sup>33</sup> Snyder's unit hydrograph method was utilized in the HEC-1 model to develop a unit hydrograph for each watershed at the proposed dam locations. Snyder's method relates hydrograph characteristics to the physical characteristics of the watershed. Two basic parameters, basin lag time and Snyder's peaking coefficient, are required to define the unit hydrograph using Snyder's method.

The basin lag time is defined as the time between the center of mass of the rainfall excess for a specified storm to the peak rate of runoff. Snyder found the basin lag time to be a function of basin size and shape expressed by:

$$t_p = C_t(L L_c)^{0.3}$$

where

- $t_p$  = basin lag time (hours),
- $C_t$  = coefficient depending on the basin properties,
- $L$  = the main stream distance from the outlet to the divide (miles),
- $L_c$  = the main stream distance from the outlet to a point opposite the basin centroid (miles).

The use of  $L$  and  $L_c$  accounts for the watershed shape and size and  $C_t$  is considered to account for wide variations in topography, from plains to mountainous regions. Values of  $C_t$  have been found to range from 0.4 for the steep regions of Southern California to 8.0 along the Gulf of Mexico. Linsley<sup>34</sup> proposed a modified form of Snyder's equation:

$$t_p = C_L \left( \frac{L L_c}{\sqrt{s}} \right)^{0.3}$$

where  $s$  is the average watershed slope (ft./ft.) and  $C_L$  is the coefficient dependent on basin properties reflecting the inclusion of slope in the equation. Known values of basin lag time can

<sup>33</sup> Chow, Ven Te, et al., op. cit., 1988.

<sup>34</sup> Linsley, Ray K., Jr., M.A. Kohler, and J.L.H. Paulhus, Hydrology for Engineers, McGraw-Hill Book Co., Third Edition, 1982.

be correlated to the watershed characteristics ( $L L_c / S^{1/2}$ ) for watersheds with similar hydrologic characteristics in order to define a regional relationship for  $C_L$ .

Snyder's peaking coefficient is used to compute the peak discharge of the unit hydrograph. The peak discharge in Snyder's unit hydrograph is expressed by the following equation:

$$Q_p = \frac{640 C_p A}{t_p}$$

where

- $Q_p$  = peak discharge of the unit hydrograph (cfs),
- $C_p$  = Snyder's peaking coefficient,
- $A$  = watershed size (sq.mi.), and
- $t_p$  = basin lag time (hours).

Snyder's peaking coefficient accounts for flood wave and storage conditions. It is a function of lag time, duration of storm producing runoff, effective drainage area contributing to the peak flow, and watershed size. Values of  $C_p$  range from 0.4 to 0.8 and generally indicate the retention or storage capacity of the watershed. Larger values of  $C_p$  are generally associated with smaller values of  $C_L$ .<sup>35</sup>

### A.3.3 Historic Flood Calibrations

The parameters,  $t_p$  and  $C_p$ , which are required to define the unit hydrograph using Snyder's method are specific to a given watershed and can be derived by an evaluation of these parameters for the study area. This is accomplished by calibrating the unit hydrograph parameters for flood events measured at gaged locations in the region. Model calibration is accomplished by simulating historical storm events and comparing the computed runoff hydrograph to the measured runoff hydrograph at a streamflow gaging station. The individual parameters are optimized in order to compute a runoff hydrograph that is comparable to the measured runoff hydrograph from the historical storm event.

Data required for model calibration includes both precipitation to describe the storm event and streamflow to describe the runoff hydrograph. A review of gage records for the region revealed several major flood events where adequate data was available for model calibration.

---

<sup>35</sup> Viesman, Warren, Jr., J.W. Knapp, G.L. Lewis, and T.E. Harbaugh, Introduction to Hydrology, Harper & Row, Second Edition, 1977.



The flood events used in the model calibrations were usually some of the larger flood events on record. A total of 46 flood events were calibrated. Data from over 70 rainfall gaging stations and 16 streamflow gaging stations were used to perform the model calibrations. The locations of the watersheds for which historical flood calibrations were performed are identified in Figure A.3-1.

For each flood event, daily, hourly, and 15-minute interval rainfall gages were identified and plotted on a watershed map. Rainfall gage data was obtained from a variety of sources, including the National Weather Service, U.S. Geological Survey (USGS), Edwards Underground Water District, and Texas Water Development Board. In general, rainfall data recorded every 15 minutes were only available at a few select gages activated in 1990, hence, hourly gages were relied upon heavily to obtain the temporal distribution of rainfall for each storm event. Obtaining rainfall data that could be used to accurately describe the storm event, especially those storm events prior to the 1980's, proved to be the primary challenge in calibration of historical flood events.

Once the rainfall gages were identified for a storm event, the Thiessen polygon procedure was employed to compute the basin average storm total rainfall. This procedure provides a method to determine the weight of each rainfall gaging station that should be applied relative to its location to the watershed area. Once the storm total rainfall was computed, the rainfall gages which could be used to describe the temporal rainfall pattern were selected. For several of the storm events, this was based on the closest hourly or 15-minute gaging station. However, for some storm events where information was available at more than one hourly or 15-minute gaging station, the data at each of the gaging stations was used to describe the pattern of rainfall.

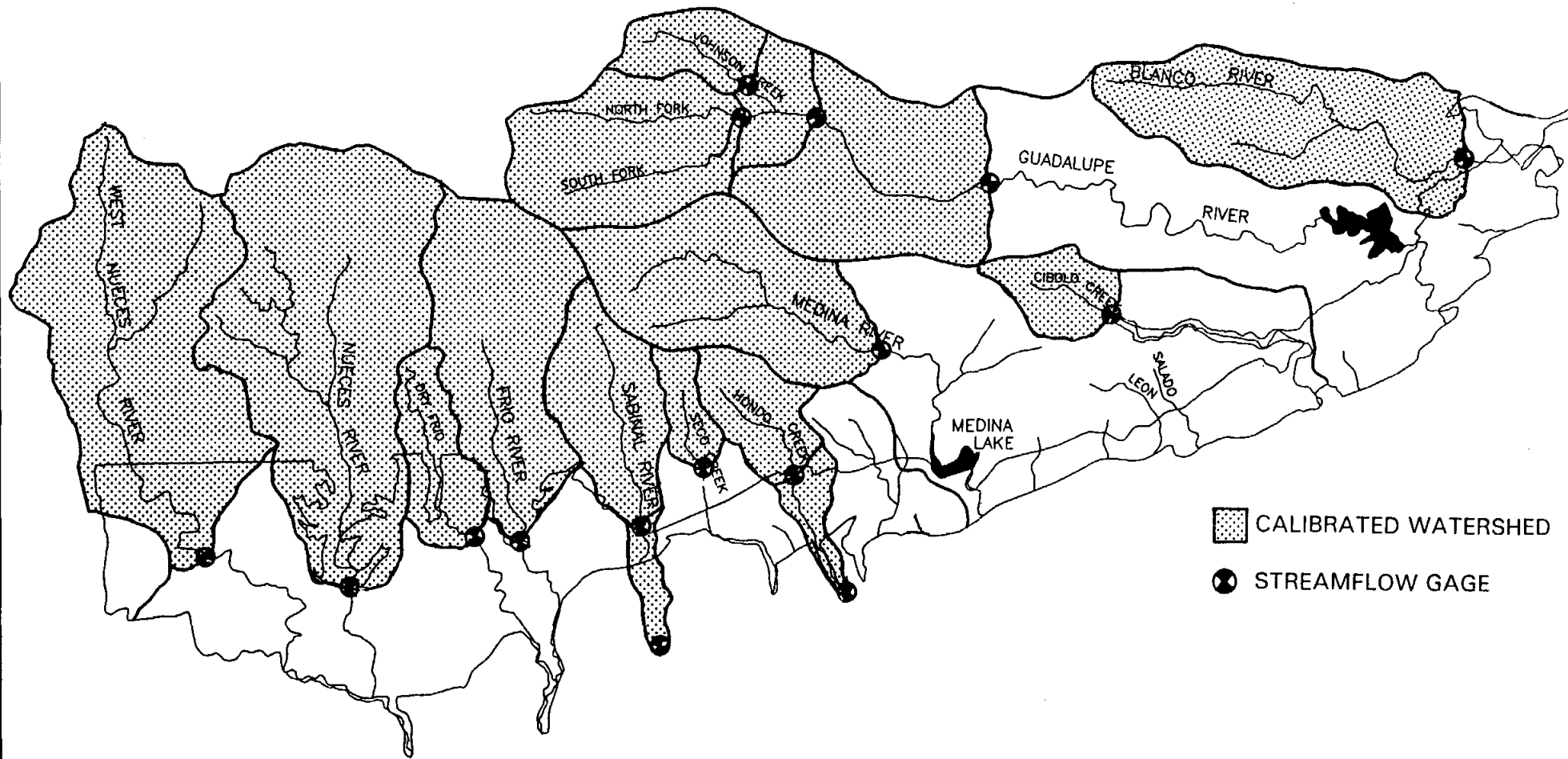
The runoff hydrograph at the streamflow gaging station used in each calibration was determined from USGS records. Data for historical flood events were usually provided by the USGS in the form of a time-stage series. The discharge for each time interval, usually one or two hours, was determined using the appropriate stage-discharge rating table for the gaging station at the time of the flood event. The baseflow component of the streamflow hydrograph was separated from the runoff component of the flood event, although it was generally found to be a relatively minor component in comparison to the volume and magnitude of the flood.



-  CALIBRATED WATERSHED
-  STREAMFLOW GAGE

GUADALUPE - SAN ANTONIO RIVER BASIN  
 RECHARGE ENHANCEMENT STUDY  
 FEASIBILITY ASSESSMENT

**HDR**  
 HDR Engineering, Inc.

TRANS TEXAS WATER PROGRAM /  
 WEST CENTRAL STUDY AREA

**HISTORICAL FLOOD  
 CALIBRATION WATERSHEDS**

FIGURE A.3-1

Calibration of flood events was accomplished by optimizing the unit hydrograph parameters and loss rate parameters until, after a number of iterations, the computed peak flow, runoff volume, and hydrograph shape closely matched the observed runoff event. The calibrations involved varying the basin lag time ( $t_p$ ), peaking coefficient ( $C_p$ ), initial loss ( $L_1$ ), and uniform loss rate ( $L_U$ ). The steep rise in the observed hydrographs, which is typical of the region, resulted in the adoption of the peaking coefficient of 0.80, the largest value HEC-1 will effectively accept. Thus, only the remaining three parameters were optimized. Since the peak of the design inflow hydrograph is of principal concern in dam and spillway designs, calibration of the peak flow for historical flood events was given the highest priority. In addition, the parameters were also calibrated to correlate the runoff volume and shape of the runoff hydrograph. The basin lag time is the primary parameter affecting the peak flow of the computed runoff hydrograph. Although the initial loss and uniform loss rate parameters also affect the computation of peak flow, they are primarily used to correlate the runoff volume. The calibration results generally showed that the peak discharge, runoff volume and shape of the runoff hydrograph, could be simulated well. Figure A.3-2 shows representative comparisons of observed runoff hydrographs and computed runoff hydrographs using calibrated model parameter for selected flood events.

In addition to the historical flood calibrations performed in this study, the U.S. Army Corps of Engineers (USCE) has also performed a number of other historical flood calibrations in the hill country region. These studies were conducted by the USCE in association with the evaluation of various flood control and water supply projects in the Nueces and Guadalupe River Basins.<sup>36</sup> A total of 16 historical flood calibrations performed by the USCE were reviewed and ultimately included in the regional data set. Overall the regional data set was comprised of 62 historical flood calibrations at 16 different locations in the region.

A range in the results of the model parameters will typically occur due to the many variables and components involved in the flood hydrograph calibrations. In order to derive the parameters to be used in computing the design inflow hydrographs for various projects, the calibrated parameters for the individual watersheds were considered on a regional basis. A

---

<sup>36</sup> U.S. Army Corps of Engineers, "Survey Report on Edwards Underground Reservoir, Guadalupe, San Antonio, and Nueces Rivers and Tributaries, Texas," Appendix II, Hydrology and Hydraulic Design, 1965.



BLANCO RIVER AT WIMBERLEY (1710)  
FLOOD OF JUNE, 1981

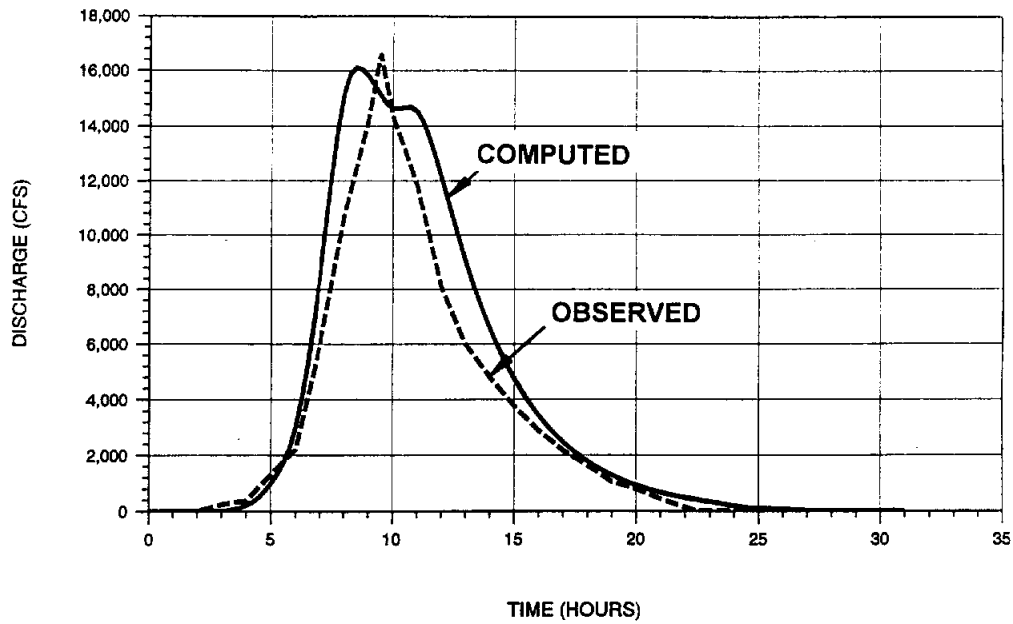

GUADALUPE RIVER AT HUNT (1655)  
FLOOD OF DECEMBER, 1984

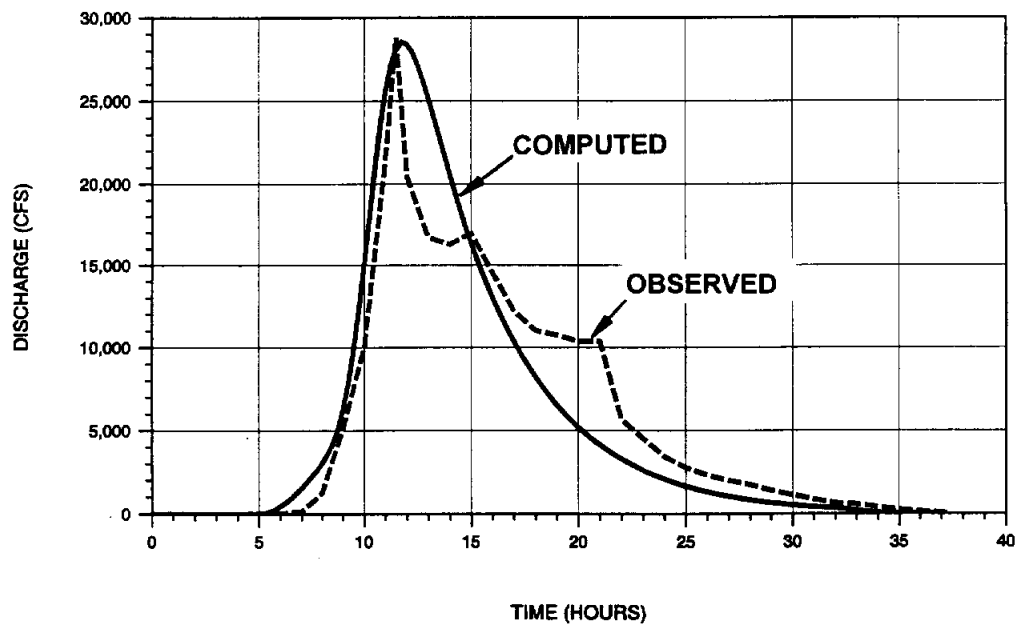

GUADALUPE - SAN ANTONIO RIVER BASIN  
RECHARGE ENHANCEMENT STUDY  
FEASIBILITY ASSESSMENT



HDR Engineering, Inc.

TRANS TEXAS WATER PROGRAM /  
WEST CENTRAL STUDY AREA

REPRESENTATIVE OBSERVED AND  
COMPUTED HYDROGRAPHS

FIGURE A.3-2

regional relationship provides a sound basis for selection of appropriate parameters for various locations in the region where projects are being considered, especially those locations which are ungauged or where little or no data exists.

The basin lag time is the primary unit hydrograph parameter that determines the design flood peak inflow and ultimately the height and size of the dam and spillway. The basin lag time can be correlated to the physical parameters of the watershed using the relationship:

$$t_p = C_L \left( \frac{L \cdot L_c}{\sqrt{S}} \right)^n$$

The length (L), length to centroid (L<sub>c</sub>), and average watershed slope (s) were computed for each of the watersheds used in the calibrations. Representative basin lag times were selected for each of the 16 watersheds after evaluating the individual calibrations and eliminating any obvious outliers. Using standard multiple linear regression techniques, the best-fit estimates of C<sub>L</sub> and n were found to be 0.15 and 0.34, respectively. The coefficient of determination (r<sup>2</sup>) for this regression was 0.68 indicating that 68 percent of the variation in basin lag time could be explained by the regression. A plot of the resulting regional lag time relationship is shown in Figure A.3-3 along with the basin lag times for each of the 16 watersheds evaluated.

The initial loss and uniform loss rate parameters calibrated for the individual floods were highly variable. The initial loss and uniform loss rate parameters are highly sensitive to the antecedent moisture condition of the watershed prior to the storm event and to the volume and pattern of the storm event. Large values of initial loss and uniform loss rates were found for many of the storm events analyzed. Due to the precipitation data being the weakest element in the historical flood calibrations, the initial and uniform loss rate parameters provide an adjustment to the basin average rainfall data in addition to representing interception, storage, and infiltration losses. Selection of appropriate parameters for use in the computation of design flood events involves engineering judgment, considering both the calibrated parameters and design parameters typically used in the region.

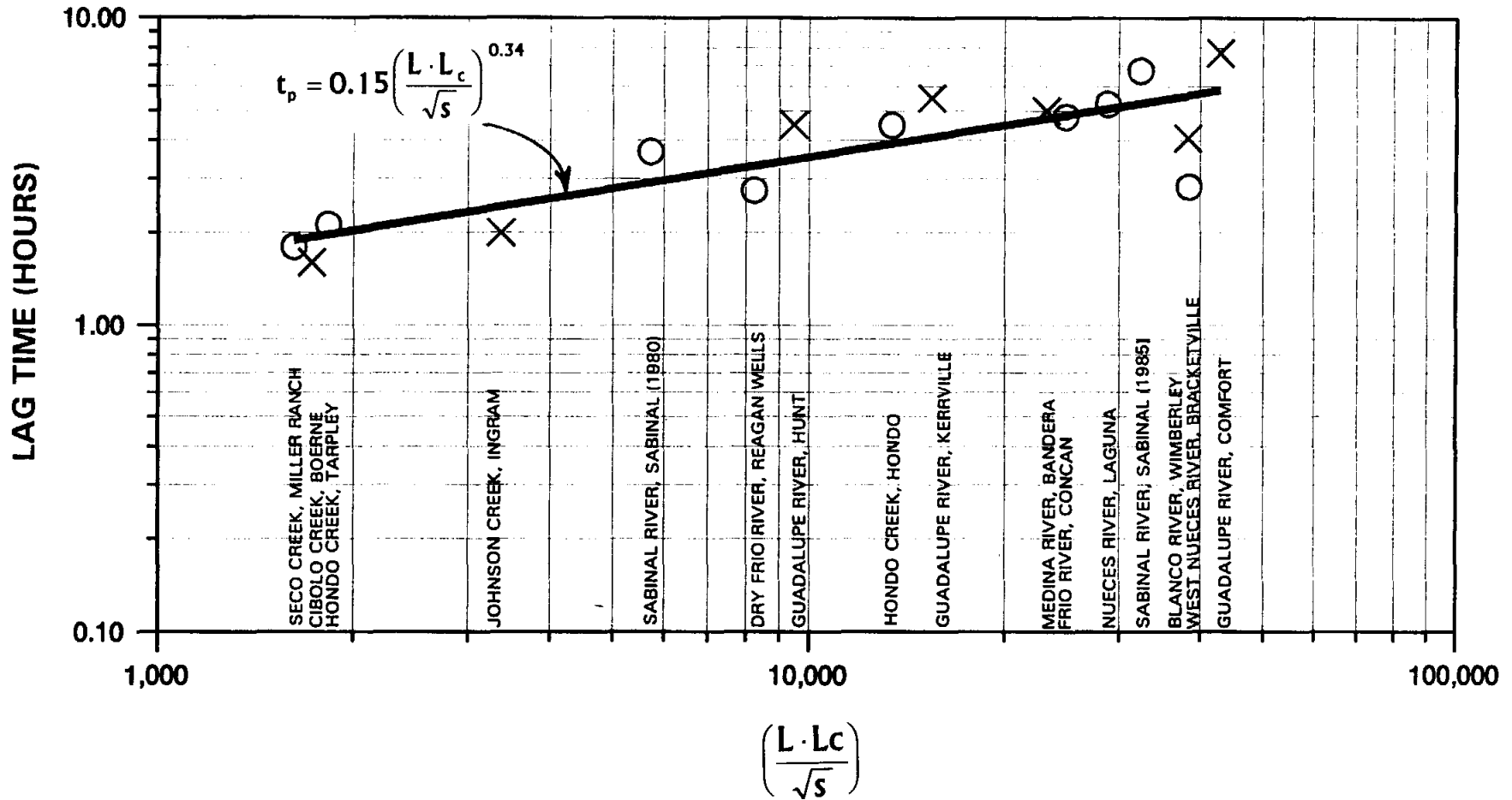

**LEGEND**

- REGIONAL LAG TIME CURVE
- X GUADALUPE-SAN ANTONIO RIVER BASIN
- O NUECES RIVER BASIN

TRANS TEXAS WATER PROGRAM /  
WEST CENTRAL STUDY AREA

**REGIONAL LAG TIME  
RELATIONSHIP**



HDR Engineering, Inc.

GUADALUPE - SAN ANTONIO RIVER BASIN  
RECHARGE ENHANCEMENT STUDY  
FEASIBILITY ASSESSMENT

FIGURE A.3-3

#### A.3.4 Model Development

An HEC-1 flood hydrology model was developed for each watershed at each recharge project location. The individual models were developed to compute the runoff hydrographs for various design flood events including the 25-year, 50-year, 100-year, and probable maximum flood events.

Design storm events were used in the HEC-1 model to generate the corresponding runoff hydrograph for each flood event. The probable maximum storm (PMS) is used in the HEC-1 model to compute the probable maximum flood. Probable maximum precipitation (PMP), which is the basis for deriving a PMS, is defined as the greatest depth of precipitation physically possible for a given set of conditions. The conditions include a given duration, area, and season. In the study area, PMP estimates are furnished by the National Oceanic and Atmospheric Administration (NOAA) in Hydrometeorological Report No. 51 (HMR No. 51)<sup>37</sup>. This publication provides PMP estimates for various combinations of storm areas and durations which are applicable to all seasons. National Weather Service criteria for developing a PMS from PMP estimates in HMR No. 51 are specified in Hydrometeorological Report No. 52.<sup>38</sup> The criteria require determination of four conditions that will produce the maximum peak discharge at a given location. These conditions are the location of the storm center, the size of the storm area, storm orientation, and the temporal arrangement of precipitation amounts. These four conditions are determined using a trial-and-error procedure that has been incorporated into the computer program HMR52. Probable maximum storms, with a total duration of 72 hours, were computed for each watershed using HMR No. 51 and HMR52 and used as input to the HEC-1 model to compute the PMF for each recharge project.

In order to compute runoff hydrographs for various return interval events (i.e., 25-year, 50-year, 100-year floods), rainfall amounts that correspond to each of these return interval events were modeled using HEC-1. Rainfall amounts for each storm event were obtained from National

---

<sup>37</sup> National Oceanic and Atmospheric Administration, "Probable Maximum Precipitation Estimates, United States East of the 105th Meridian," Hydrometeorological Report No. 51, June, 1978.

<sup>38</sup> Hydrologic Engineering Center, "HMR52 Probable Maximum Storm (Eastern United States) Users Manual", U.S. Army Corps of Engineers, March, 1984.

Weather Service TP-40<sup>39</sup> and National Weather Service HYDRO-35.<sup>40</sup> These values were used in HEC-1 to develop 24-hour duration design storms for determining runoff hydrographs for the corresponding return interval flood events. The storm rainfall was distributed using the "balanced storm" procedure in HEC-1, which creates a triangular shaped hyetograph from the given rainfall depths. Aerial rainfall reduction factors were used in the model to reduce the point rainfall amounts from TP-40 and HYDRO-35 to an average depth for the larger watersheds. HEC-1 reduces the point rainfall amounts according to recommendations in TP-40. A 24-hour rainfall depth summary for each recharge project is provided in Table A.3-3.

<b>Recharge Project</b>	<b>Watershed Area (sq.mi.)</b>	<b>24-Hour Storm Totals<sup>1</sup></b>		
		<b>25-year Storm Rainfall (inches)</b>	<b>100-year Storm Rainfall (inches)</b>	<b>Probable Maximum Storm Rainfall<sup>2</sup> (inches)</b>
Upper Blanco	392	6.99	8.92	27.29
Lower Blanco	409	6.99	8.92	27.05
Cibolo	261	7.02	8.97	28.61
San Geronimo	53	7.24	9.24	34.51
Government Canyon	11.7	7.51	9.58	39.35
Deep Creek	4.7	7.57	9.66	39.36
Culebra	1.8	7.60	9.70	39.37
Lime Kiln	1.2	7.61	9.70	39.38
Salado Creek Site No. 3	27.9 <sup>3</sup>	7.52	9.59	39.16

**Notes:**

1. 24-hour storm totals include the application of areal rainfall reduction factors.
2. 72-hour storm used to compute the PMF. Maximum basin average 24-hour storm total listed for comparison purposes.
3. Watershed area shown for Salado Creek Site No. 3 is total watershed area. Approximately 17.0 sq. mi. of the upstream watershed is controlled.

<sup>39</sup> National Weather Service, "Rainfall Frequency Atlas of the United States for Durations from 30 Minutes to 24 Hours and Return Periods from 1 to 100 Years," Technical Paper No. 40, U.S. Department of Commerce, May, 1961.

<sup>40</sup> National Weather Service, "Five- to 60-Minute Precipitation Frequency for the Eastern and Central United States," NOAA Technical Memorandum NWS Hydro-35, Office of Hydrology, Silver Spring, MD, June, 1977.

The unit hydrograph parameters required by the HEC-1 model for Snyder's method include the basin lag time ( $t_p$ ) and peaking coefficient ( $C_p$ ). The peaking coefficient was set to 0.80, the maximum value allowed in HEC-1, in order to simulate the rapid rise of the runoff hydrographs typical of the region. The basin lag time for the watershed of each recharge project was determined using the regional relationship derived from the historical flood calibrations expressed as

$$t_p = 0.15 \left( \frac{L L_c}{\sqrt{s}} \right)^{0.34}$$

The watershed length ( $L$ ), length to centroid ( $L_c$ ), and average slope ( $s$ ) were computed for each project and the resulting lag time was computed from the above equation.

The initial and uniform loss rate function was used in HEC-1 to represent precipitation losses. The initial loss and uniform loss rate parameters were selected based on engineering judgment considering the results of the historic flood calibrations and values typically used for design storms in the region. Selection of the initial and uniform loss rate parameters depend on the flood event being analyzed. For the probable maximum flood, hydrologic parameters are used which would maximize the runoff for the watershed. Saturated watershed conditions are usually assumed when simulating the PMF. For flood events less in magnitude than the PMF (i.e., 25-year, 50-year, 100-year floods), parameters are generally selected which represent average or normal runoff conditions. Table A.3-4 provides a summary of the unit hydrograph and initial and uniform loss rate parameters used in the flood hydrology models for each recharge project.

### A.3.5 Model Results

Execution of the HEC-1 flood hydrology models provide the necessary data to determine the dam height and spillway requirements for each recharge project. The results are in the form of a runoff hydrograph for each simulated storm event which serves as inflow to the recharge project site. A summary of the peak discharge and total runoff volume for the 25-year, 100-year, and probable maximum flood events is provided in Table A.3-5 along with a comparison with the maximum recorded historical flood event, if available, for each stream.

**Table A.3-4  
Summary of Flood Hydrology Model Parameters**

Recharge Project	Watershed Characteristics				Unit Hydrograph Parameters		Initial and Uniform Loss Rate Parameters			
	A (sq.mi.)	L miles	L <sub>c</sub> miles	s ft/ft	t <sub>p</sub> hours	C <sub>p</sub>	Flood Events Less than PMF		PMF	
							L <sub>i</sub> inches	L <sub>U</sub> in/hr	L <sub>i</sub> inches	L <sub>U</sub> in/hr
Upper Blanco	392	72.6	37.1	0.0026	6.1	0.8	2.0	0.2	0.0	0.15
Lower Blanco	409	75.0	38.7	0.0026	6.2	0.8	2.0	0.2	0.0	0.15
Cibolo	261	61.1	35.5	0.0026	5.6	0.8	2.0	0.2	0.0	0.15
San Geronimo	53	18.5	11.4	0.0051	2.3	0.8	2.0	0.2	0.0	0.15
Government Canyon	11.7	7.4	4.0	0.0135	1.0	0.8	N/A	N/A	0.0	0.15
Culebra	1.8	2.3	1.3	0.0369	0.4	0.8	N/A	N/A	0.0	0.15
Lime Kiln	1.2	1.5	0.9	0.0521	0.3	0.8	N/A	N/A	0.0	0.15
Salado Creek Site No. 3	27.9	10.7	6.3	0.0080	1.4	0.8	N/A	N/A	0.0	0.15
Deep Creek	4.7	4.5	2.7	0.0155	0.7	0.8	N/A	N/A	0.0	0.15

Notes:

A	watershed area	t <sub>p</sub>	basin lag time
L	watershed length	C <sub>p</sub>	peaking coefficient
L <sub>c</sub>	watershed length to centroid	L <sub>i</sub>	initial loss
s	average watershed slope	L <sub>U</sub>	uniform loss rate

**Table A.3-5  
Flood Hydrology Summary**

Recharge Enhancement Project	Watershed Area (sq.mi.)	25-Year Flood		100-Year Flood		PMF		Historic Records			
		24-hr Rainfall (inches)	Peak Flow (cfs)	24-hr Rainfall (inches)	Peak Flow (cfs)	24-hr Rainfall (inches)	Peak Flow (cfs)	Maximum Peak Flow (cfs)	Year	Station and Watershed Area	Period of Record (years)
Upper Blanco	392	6.99	100,000	8.92	146,000	27.29	638,000	139,000	1929	081713000 412 sq.mi.	70
Lower Blanco	409	6.99	104,000	8.92	151,000	27.05	656,000	139,000	1929	081713000 412 sq.mi.	70
Cibolo	261	7.02	73,000	8.97	105,000	28.61	476,000	69,600	1997	08185000 274 sq.mi.	52
San Geronimo	53	7.24	35,000	9.24	48,000	34.51	212,000	N/A	N/A	N/A	N/A
Government Canyon <sup>2</sup>	11.7	N/A	N/A	N/A	N/A	39.16	92,000	N/A	N/A	N/A	N/A
Culebra <sup>2</sup>	1.8	N/A	N/A	N/A	N/A	39.37	19,000	N/A	N/A	N/A	N/A
Lime Kiln <sup>2</sup>	1.2	N/A	N/A	N/A	N/A	39.38	13,000	N/A	N/A	N/A	N/A
Salado Creek Site 3 <sup>2,3</sup>	27.9	N/A	N/A	N/A	N/A	39.16	189,000	N/A	N/A	N/A	N/A
Deep Creek <sup>2</sup>	4.7	N/A	N/A	N/A	N/A	39.36	43,000	N/A	N/A	N/A	N/A

Notes:

- 72-hour storm used to compute the PMF. Maximum basin 24-hr storm total listed for comparison purposes.
- Government Canyon, Culebra, Lime Kiln, Salado Creek Site 3, and Deep Creek site were sized to provide storage for the 100-year flood runoff. Peak inflow for the 25-year and 100-year floods were not computed. Dam height and spillway width were sized to pass the PMF.
- Salado Creek Site 3 was sized to provide storage for the 100-year flood runoff for the uncontrolled area (10.9 sq.mi.). Approximately 17.0 sq.mi. is controlled upstream of Site 3. The total watershed area (27.9 sq.mi.) was used for computation of the PMF for Site 3.



(This page intentionally left blank)

## **A.4 Project Feasibility Designs and Cost Estimates**

### **A.4.1 Dam, Spillway, and Appurtenant Works**

Four different dam and spillway configurations were considered for the recharge projects examined in this study. These include: 1) an embankment dam with a relatively thin, central-clay core, rockfill shells, and a side-channel rock cut auxiliary spillway (see Figures A.4-1 and A.4-2); 2) a composite dam consisting of a roller compacted concrete (RCC) gravity dam with overflow section connected to each abutment with embankment dams as previously described (see Figures A.4-3 and A.4-4); 3) a RCC gravity dam with overflow section spanning the entire valley (see Figures A.4-5 and A.4-4); and 4) a RCC channel dam (see Figures A.4-6 and A. 4-7).

The selection and conceptual design of these dam types are based on the following key observations/assumptions regarding the project sites: 1) the availability of clayey material for use in a dam core appears to be limited and of marginal quality; 2) an abundance of material suitable for use in constructing random fill and rockfill outer shells of an embankment dam could be obtained from the excavation of a side channel auxiliary spillway; 3) foundation strengths appear to be adequate to support an RCC gravity dam and/or the relatively steep slopes of a rockfill dam; and 4) sufficient quantities of aggregate for manufacturing RCC can be derived from local terrace deposits and/or quarried and processed rock.

The overflow spillway crest elevation was set at the recharge pool elevation for the three dam types that utilize RCC for the spillway. Properly designed and constructed RCC can withstand frequent overtopping flows without jeopardizing the structural integrity of the spillway. For the embankment dam alternative, the side-channel rock cut auxiliary spillway was set five feet above the recharge pool elevation. Depending on the integrity of the natural materials in which this type of spillway is excavated, it is typically desirable to minimize the frequency of flows through this type of spillway to reduce the potential for erosion damage. Because of the higher crest elevation and hydraulic inefficiencies relative to an RCC overflow section, a higher dam crest elevation is needed for the embankment dam alternative to safely pass the probable maximum flood (PMF) without overtopping.

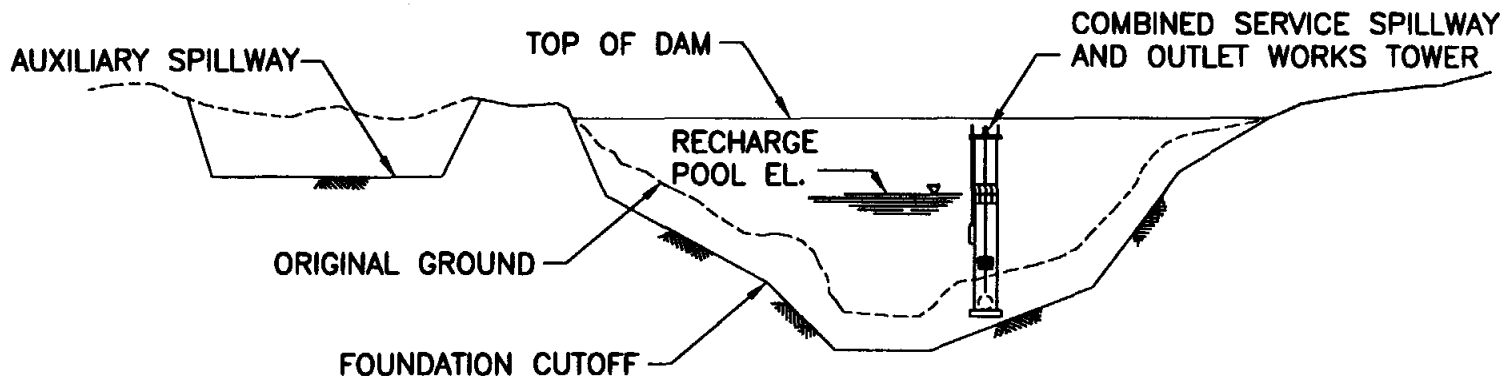

**EMBANKMENT DAM WITH SIDE CHANNEL AUXILIARY SPILLWAY**

TRANS TEXAS WATER PROGRAM /  
WEST CENTRAL STUDY AREA

**EMBANKMENT DAM PROFILE**

GUADALUPE - SAN ANTONIO RIVER BASIN  
RECHARGE ENHANCEMENT STUDY  
FEASIBILITY ASSESSMENT



HDR Engineering, Inc.

FIGURE A.4-1

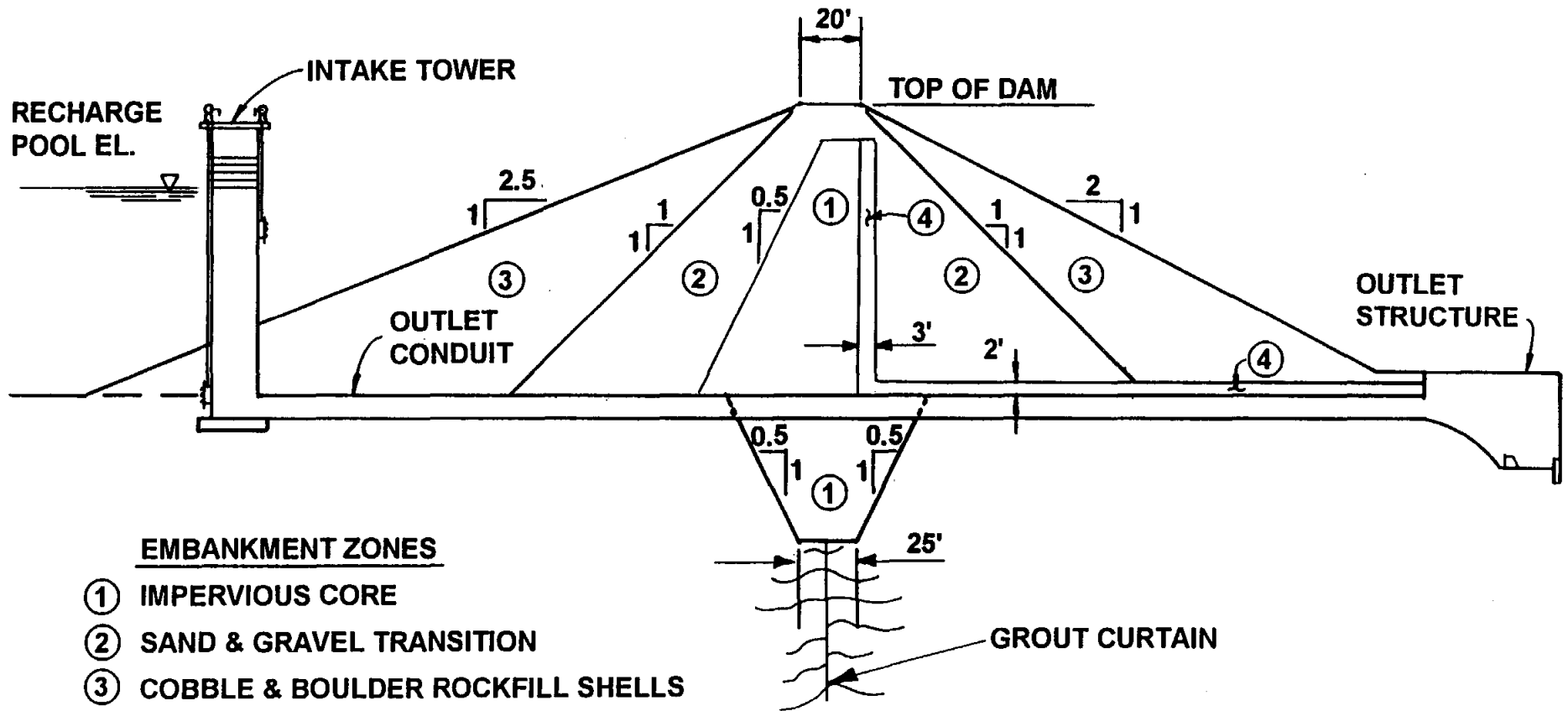

**EMBANKMENT ZONES**

- ① IMPERVIOUS CORE
- ② SAND & GRAVEL TRANSITION
- ③ COBBLE & BOULDER ROCKFILL SHELLS
- ④ PROCESSED FILTER/DRAIN

GROUT CURTAIN

TRANS TEXAS WATER PROGRAM /  
WEST CENTRAL STUDY AREA

**EMBANKMENT DAM SECTION**

GUADALUPE - SAN ANTONIO RIVER BASIN  
RECHARGE ENHANCEMENT STUDY  
FEASIBILITY ASSESSMENT



HDR Engineering, Inc.

FIGURE A.4-2

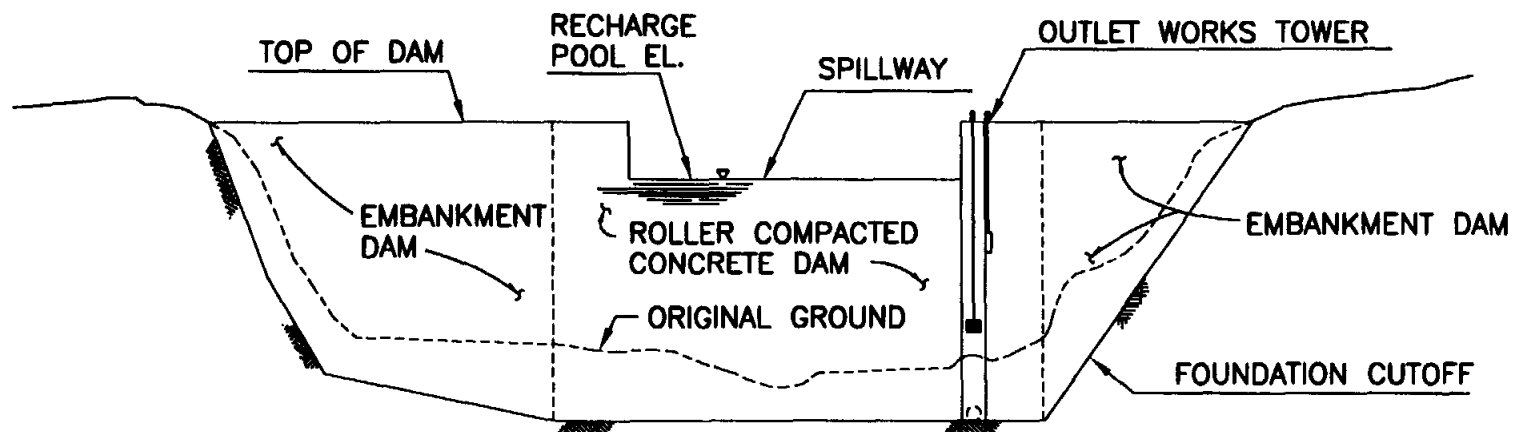

**COMPOSITE EMBANKMENT/ROLLER COMPACTED CONCRETE  
GRAVITY DAM WITH OVERFLOW SPILLWAY**

TRANS TEXAS WATER PROGRAM /  
WEST CENTRAL STUDY AREA  
**COMPOSITE DAM PROFILE**

GUADALUPE - SAN ANTONIO RIVER BASIN  
RECHARGE ENHANCEMENT STUDY  
FEASIBILITY ASSESSMENT



HDR Engineering, Inc.

FIGURE A.4-3

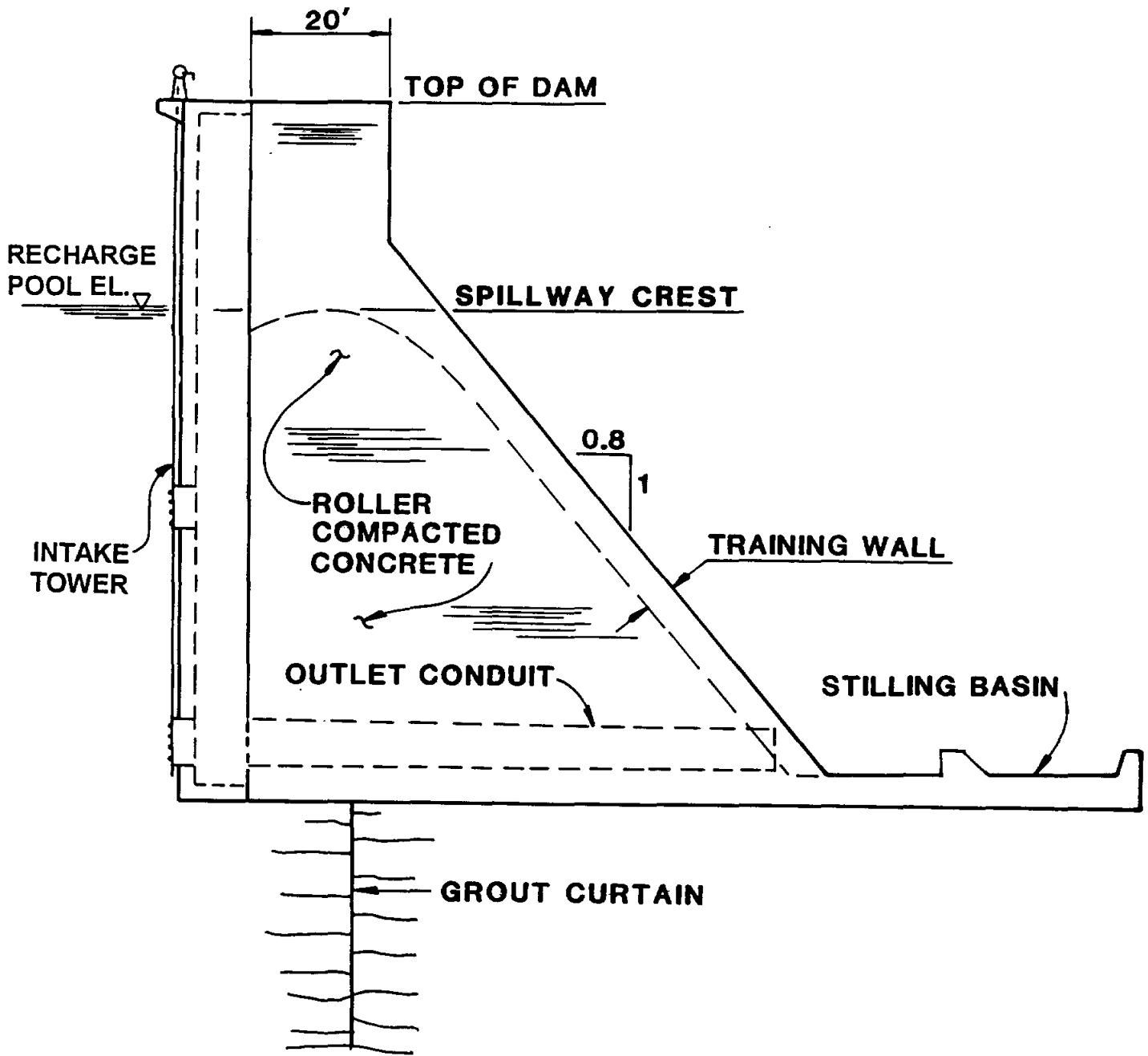

GUADALUPE - SAN ANTONIO RIVER BASIN  
 RECHARGE ENHANCEMENT STUDY  
 FEASIBILITY ASSESSMENT

TRANS TEXAS WATER PROGRAM /  
 WEST CENTRAL STUDY AREA

ROLLER COMPACTED CONCRETE  
 GRAVITY DAM SECTION



HDR Engineering, Inc.

FIGURE A.4-4

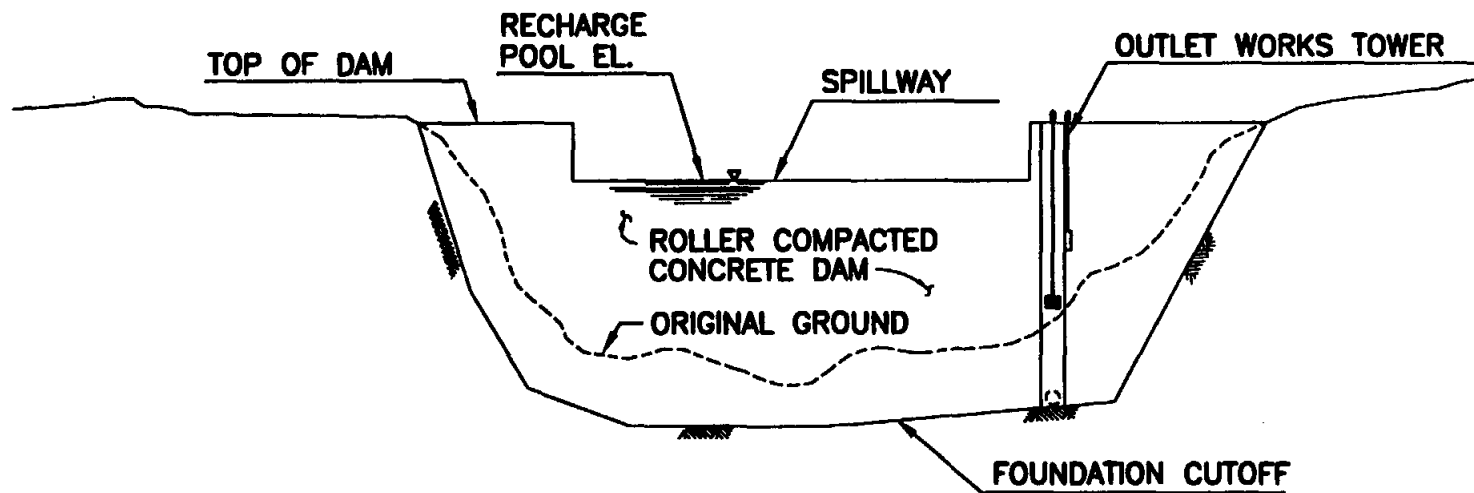

**ROLLER COMPACTED CONCRETE GRAVITY DAM  
WITH OVERFLOW SPILLWAY**

TRANS TEXAS WATER PROGRAM /  
WEST CENTRAL STUDY AREA

**RCC GRAVITY DAM PROFILE**

GUADALUPE - SAN ANTONIO RIVER BASIN  
RECHARGE ENHANCEMENT STUDY  
FEASIBILITY ASSESSMENT



HDR Engineering, Inc.

FIGURE A.4-5

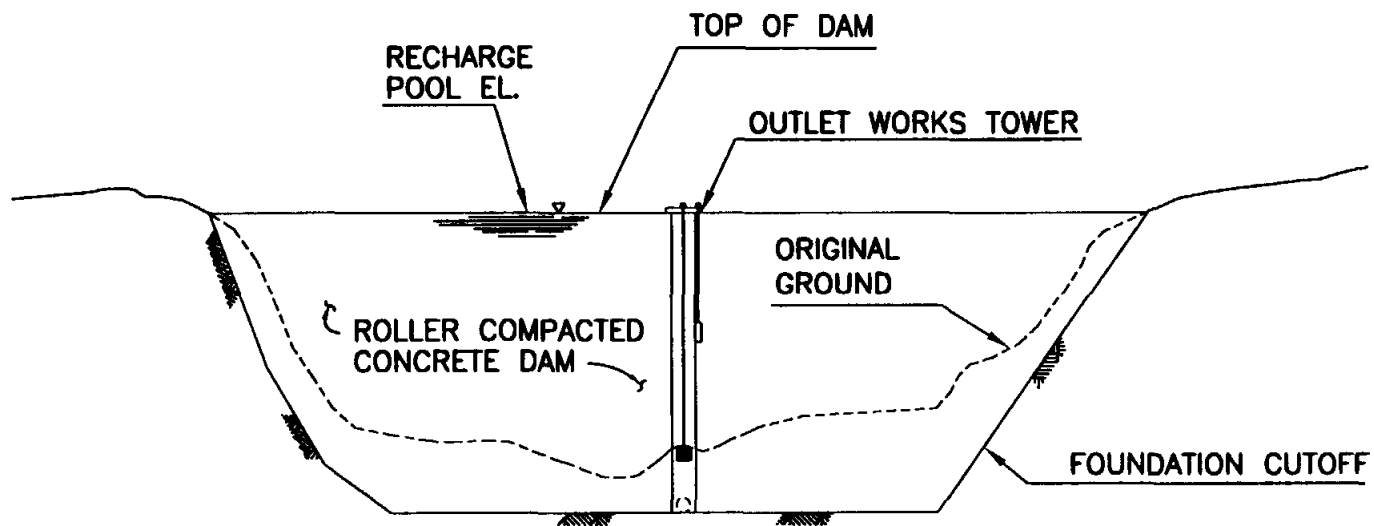

**ROLLER COMPACTED CONCRETE CHANNEL DAM**

TRANS TEXAS WATER PROGRAM /  
WEST CENTRAL STUDY AREA

**RCC CHANNEL DAM PROFILE**

GUADALUPE - SAN ANTONIO RIVER BASIN  
RECHARGE ENHANCEMENT STUDY  
FEASIBILITY ASSESSMENT



HDR Engineering, Inc.

FIGURE A.4-6



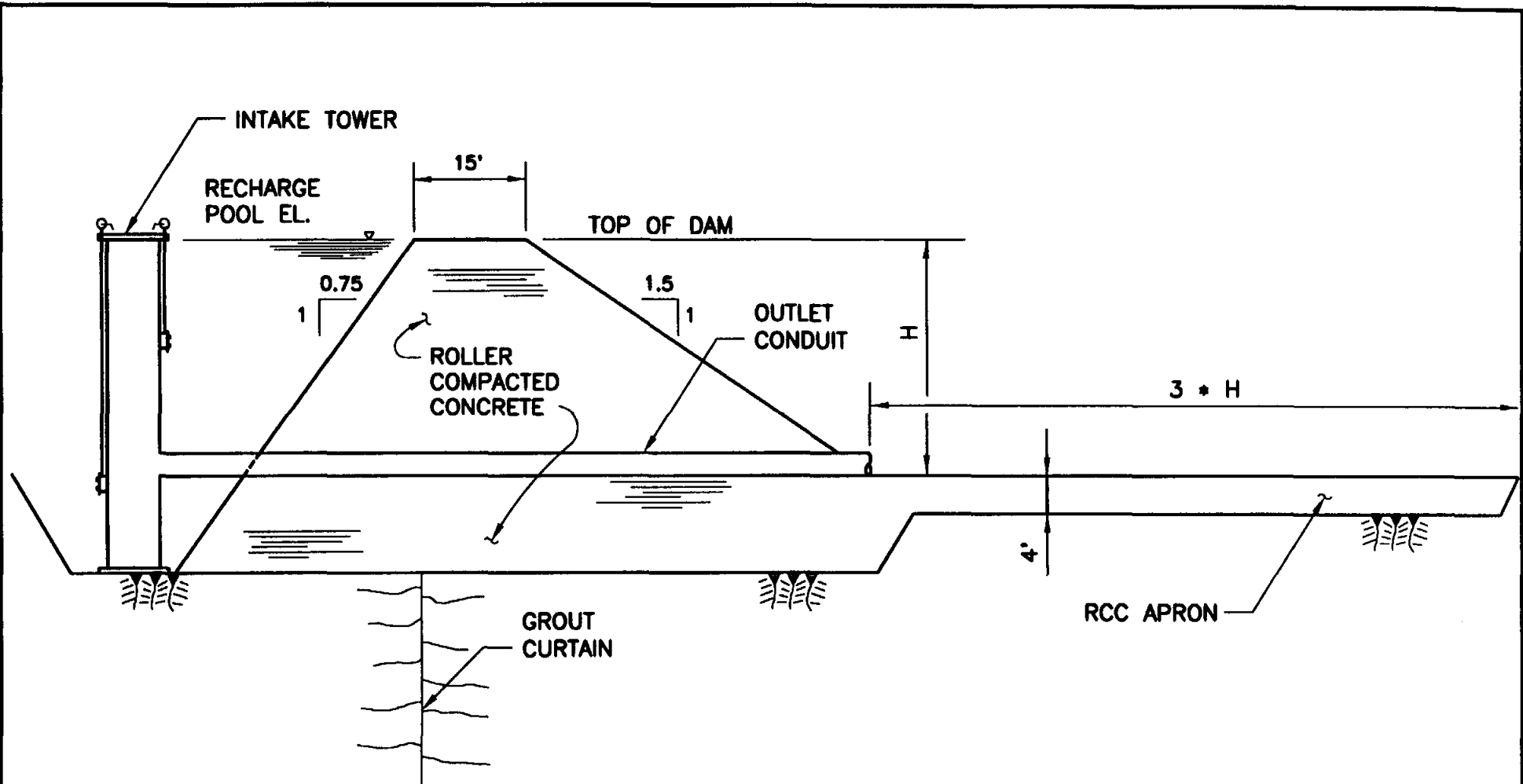

GUADALUPE - SAN ANTONIO RIVER BASIN  
 RECHARGE ENHANCEMENT STUDY  
 FEASIBILITY ASSESSMENT



HDR Engineering, Inc.

TRANS TEXAS WATER PROGRAM /  
 WEST CENTRAL STUDY AREA

**ROLLER COMPACTED CONCRETE  
 CHANNEL DAM SECTION**

FIGURE A.4-7

Spillway widths were generally selected to limit the depth of flow in the spillway to between 25 and 30 feet during the PMF. For the embankment dam, the spillway width was also adjusted to provide a better balance between the required spillway excavation and the amount of material required to construct the dam shells (material zones 2 and 3). For the largest recharge pool capacities considered at certain sites (San Geronimo and Lower Blanco), the spillway width had to be increased so that the top of dam elevation did not exceed topographic limitations at the proposed dam site.

A low-flow outlet works was incorporated into each conceptual dam design. For the embankment dam alternative, the outlet works would consist of a concrete intake tower near the upstream toe of the dam, a conduit passing through the base of the dam, and an energy dissipation structure at the downstream end of the conduit, as shown in Figure A.4-2. For the RCC channel dam, the outlet works would consist of a concrete intake tower near the upstream toe of the dam and a conduit passing through the base of the dam, which would discharge directly onto the downstream apron (see Figure A.4-5). For the RCC gravity and RCC composite dams, the concrete intake tower would be cast into the vertical upstream face of the RCC section, as illustrated in Figure A.4-3. Flow would discharge from the conduit directly onto the spillway stilling basin, eliminating the need for a separate energy dissipation structure. The intake towers for each option would include a low-flow gate and two other gates at selected levels within the recharge pool. For the embankment dam alternative, the intake tower would also contain an uncontrolled overflow crest at the recharge pool elevation to pass minor flood events without engaging the auxiliary side-channel spillway. The top of the intake tower was assumed to be at approximately the 100-year flood level for the embankment dam alternative and at the top of the dam for the RCC gravity and RCC composite dam options. The top of the intake tower was set at the overflow elevation for the RCC channel dam alternative. Outlet conduits were sized to pass downstream water rights releases as described in Section A.2.2. A minimum conduit diameter of 48 inches was assumed to facilitate maintenance.

Computer spreadsheets were developed for each conceptual dam type to rapidly calculate material quantities and construction costs for different recharge pool capacities and auxiliary spillway widths. The spreadsheets utilize the average end area method to calculate construction material quantities, given the dam centerline profile and a top of dam elevation determined from

the PMF routing analyses for each recharge pool capacity and spillway width. Unit cost data presented in Table A.4-1 were used in the spreadsheets to calculate construction costs. These are the same unit costs that were utilized by HDR in Phase IVA of the Nueces River Basin Recharge Enhancement Project, completed in 1994 for the Edwards Underground Water District.<sup>41</sup>

Item	Unit	Unit Cost (\$)
Impervious Clay Core	CY	3.00
Sand & Gravel Transitions (Fine Random)	CY	2.00
Rockfill Shells (Coarse Random)	CY	4.00
Processed Filter/Drain	CY	20.00
Foundation Excavation <sup>1</sup>	CY	2.00 to 3.00
Reinforced Concrete — Towers	CY	400.00
Reinforced Concrete — Walls	CY	300.00
Reinforced Concrete — Slabs	CY	160.00
Roller Compacted Concrete	CY	50.00
Grouting	LF	30.00
Intake Tower Gates	LS	52,500
Highway Relocations		
Flat Terrain	LF	125.00
Rolling Terrain	LF	175.00
Mountainous Terrain	LF	225.00
Bridge Deck (40' Wide)	LF	1,600.00
County/Private Road Relocations		
Paved	LF	50.00
Gravel	LF	25.00

<sup>1</sup>Unit cost varies depending on relative proportions of soil versus rock excavation.

<sup>41</sup> HDR, op. cit., June, 1994.

The total construction cost for each dam was estimated using the above unit cost data from mid-1994. The total cost was then updated to the end of first quarter 1996 cost level using the U.S. Bureau of Reclamation Construction Cost Index (USBR CCI) for earth or concrete dams, as appropriate. A similar calculation was performed for road relocation costs; the USBR CCI for secondary roads was used to update the cost estimates from mid-1994 to the first quarter of 1996.

#### A.4.2 Road Relocations

Road relocations necessitated by the development of each recharge enhancement project were determined using USGS 7.5-minute topographic maps. State and U.S. Highways were relocated above the 50-year flood level, in accordance with current Texas Department of Transportation (TxDOT) criteria. The 50-year flood pool elevations were established assuming the reservoir would be empty at the beginning of the flood, with the exception of the Upper Blanco Project which was assumed to be at full capacity and the Lower Blanco Project which was assumed to be at 50 percent of capacity. Private gravel and paved roads providing access to houses or other structural improvements that were anticipated to remain following project development were generally relocated above the 50-year flood pool level. Road relocation costs were estimated, as necessary, for each recharge pool capacity evaluated at a site.

Relocated highway alignments were selected to minimize cost by avoiding mountainous terrain and stream crossings whenever possible. Both highway and private road relocation costs were calculated using unit prices per linear foot based on consultation with offices of the TxDOT and on bid tabulations for comparable work in Texas. Highway relocation costs were calculated by classifying segments of the revised alignment according to terrain. Terrain classifications and associated unit costs in dollars per linear foot are shown in Table A.4-1. Highway bridge replacements were based on utilizing a 40-foot wide bridge deck at a cost of \$40/square foot, resulting in the cost per linear foot of \$1,600. Private road relocation costs were calculated for paved and gravel roads at the corresponding unit costs shown in Table A.4-1.

#### A.4.3 Land Acquisition

A significant component of capital cost for the recharge enhancement projects is the cost of land acquisition. For the purposes of this study, it was assumed that all periodically inundated

land up to the 25-year flood level would be purchased outright and that a flood easement would be obtained at 50 percent of the land value for the acreage between the 25-year and 100-year flood levels. A review of rural land values<sup>42</sup> for the counties included in the study and discussions with the project sponsors resulted in the selection of estimated purchase and easement costs shown in Table A.4-2.

<b>Table A.4-2 Land Prices</b>		
<b>County</b>	<b>Purchase (\$/acre)</b>	<b>Easement (\$/acre)</b>
Hays	5,000	2,500
Comal	3,000	1,500
Bexar	3,000	1,500
Medina	1,000	500

An additional cost of \$50,000 per unit was included for purchase of structural improvements noted on the topographic maps as being within the 100-year flood pool. The 25- and 100-year flood pool elevations were established assuming the reservoir would be empty at the beginning of the flood, with the exception of the Upper Blanco Project which was assumed to be at full capacity and the Lower Blanco Project which was assumed to be at 50 percent of capacity.

**A.4.4 Environmental Mitigation**

Estimated environmental mitigation costs were developed by Paul Price Associates, Inc. (PPA) for a specific proposed recharge pool capacity at each project site. These costs include environmental studies and reports, archaeological work, and, if necessary, costs for habitat evaluations and acquisition and management of mitigation lands. Environmental mitigation costs for different size (smaller or larger) recharge pool capacities at each project were estimated by scaling costs based on a ratio of the recharge pool acreage. A detailed summary of pertinent

---

<sup>42</sup> Gilliland, C.E., and Semien, A., "Technical Report 1210 - Rural Land Values in the Southwest: First Half, 1997," Real Estate Center, Texas A&M University, College Station, Texas, December, 1997.

environmental considerations and an explanation of environmental mitigation costs is provided in Appendix B.

#### A.4.5 Downstream Impacts Mitigation

Costs for mitigation to offset downstream impacts to the streamflows at the Saltwater Barrier on the Guadalupe River have been included in the project cost estimates. As simulated impacts to water rights and fishery harvest were negligible, mitigation costs were approximated based on the average reduction in streamflows at the Saltwater Barrier during the 10-year drought of record (1947-56). For each recharge project evaluated, the resulting drought average annual reduction in streamflow at the Saltwater Barrier was multiplied by a unit cost of \$3 per acre-foot per year. This unit cost is approximately 5 percent of the unit cost of firm water from Canyon Lake, which the Guadalupe-Blanco River Authority sells for \$61 per acre-foot. This component of the project cost is believed to represent a “worst case” with respect to mitigation of minimal impacts on freshwater inflows to the Guadalupe Estuary.

#### A.4.6 Miscellaneous Project Costs

Based on comparable reservoir projects, engineering, permitting, legal, financial, and other miscellaneous costs associated with project development were assumed to total 20 percent of related capital costs. Project capital costs were annualized based on a 25-year finance period and an annual interest rate of 8.0 percent. Annual operations and maintenance (O&M) costs were assumed to be approximately 0.4 percent of the total capital cost of each project.

(This page intentionally left blank)

**APPENDIX B**

**ENVIRONMENTAL REPORT BY  
PAUL PRICE ASSOCIATES, INC.**



**APPENDIX B**

**ENVIRONMENTAL REPORT BY  
PAUL PRICE ASSOCIATES, INC.**

PPA 0238

**GUADALUPE - SAN ANTONIO RIVER BASIN  
RECHARGE ENHANCEMENT STUDY**

Prepared for

HDR Engineering, Inc.  
2211 South IH 35, Suite 300  
Austin, Texas 78741

by

Paul Price Associates, Inc.  
3006 Bee Caves Road, Suite D-230  
Austin, Texas 78746

February 1998

PPA 0238

**GUADALUPE - SAN ANTONIO RIVER BASIN  
RECHARGE ENHANCEMENT STUDY**

Prepared for

HDR Engineering, Inc.  
2211 South IH 35, Suite 300  
Austin, Texas 78741

by

Paul Price Associates, Inc.  
3006 Bee Caves Road, Suite D-230  
Austin, Texas 78746

February 1998

## TABLE OF CONTENTS

<u>Section</u>		<u>Page</u>
1.0	INTRODUCTION	1
1.1	Purpose and Scope	1
1.2	Methods and Materials	4
2.0	REGIONAL SETTING	4
2.1	Land and Climate	5
2.2	Habitats and Biogeography	5
	Edwards Plateau	6
	Balcones Escarpment	9
	Blackland Prairie	10
	South Texas Plains	11
2.3	Edwards Aquifer	11
2.4	Guadalupe-San Antonio River Basin	15
2.5	Protected and Important Species	18
2.6	Land Use and Economy	29
2.7	Cultural Resources	32
3.0	RECHARGE SITE SUMMARY AND ENVIRONMENTAL IMPACTS EVALUATION MATRIX	33
3.1	Recharge Site Characteristics	33
3.2	Potential Environmental Effects and Mitigation Requirements	40

## LIST OF TABLES

<u>Table</u>		<u>Page</u>
1	Endangered, Threatened and Important Species For Bexar (BX), Comal (CM), Hays (HA) and Medina (MD) Counties, Texas.	19
2	Endangered, Threatened and Important Species Associated with Subterranean Waters of the Edwards Aquifer.	28
3	Land Use and Employment in Medina, Bexar, Comal, and Hays Counties.	30
4	Recharge Site Summary.	34
5	Endangered, Threatened and Important Species and Habitats Reported to be in the Area of the Proposed Recharge Sites by the Texas Parks and Wildlife Department, Resource Protection Division's Data Mapping Files.	38
6	Environmental Impact Evaluation Matrix.	
7	Projected Costs	46

## LIST OF FIGURES

<u>Figure</u>		<u>Page</u>
1	Location of Potential Recharge Enhancement Projects, Guadalupe - San Antonio River Basin Recharge Enhancement Study Feasibility Assessment.	2
2	Ecoregions of Texas, Guadalupe - San Antonio River Basin, Recharge Enhancement Study, Medina, Bexar, Comal, and Hays Counties, Texas.	7
3	Vegetational Areas of Texas, Guadalupe - San Antonio River Basin, Recharge Enhancement Study, Medina, Bexar, Comal, and Hays Counties, Texas.	8
4	Biotic Provinces of Texas, Guadalupe - San Antonio River Basin, Recharge Enhancement Study, Medina, Bexar, Comal, and Hays Counties, Texas.	12
5	Edwards Aquifer and Catchment Area, Guadalupe - San Antonio River Basin, Recharge Enhancement Study, Medina, Bexar, Comal, and Hays Counties, Texas.	14

## 1.0 INTRODUCTION

### 1.1 Purpose and Scope

Phase I of the Guadalupe - San Antonio River Recharge Enhancement Study concluded that significant potential exists for the enhancement of Edwards Aquifer recharge through the implementation of programs of identified projects.<sup>1</sup> During the first phase, a completed river basin aquifer model was applied to calculate the maximum quantities of recharge enhancement potentially available which could reasonably be obtained without regard to costs or environmental concerns. Based on those model calculations, eight recharge enhancement projects were selected for a Phase II - Preliminary Feasibility Assessment (Figure 1). Seven of the projects would require new construction, while the remaining project would be accomplished by modification of Soil Conservation Service / Flood Retardation Structures (SCS/FRS). The focus of the Phase II - Preliminary Feasibility Assessment report is on optimizing the size of each of the identified projects on the basis of cost per unit of recharge enhancement while considering any potentially significant environmental impacts associated with development.

The eight projects are:

- ◆ Clopton Crossing
- ◆ Upper Blanco (above Halifax Creek confluence)
- ◆ Lower Blanco
- ◆ Cibolo Creek Dam No. 1
- ◆ Dry Comal Creek
- ◆ Northern Bexar County Recharge (program of five small projects)
- ◆ San Geronimo Creek
- ◆ Modification of SCS/FRS Outlets

This report examines the potentially significant environmental impacts associated with the development of five of the possible recharge enhancement projects. Clopton Crossing , Dry Comal Creek , and the Modification of SCS/FRS Outlets are not addressed in this report. The Clopton Crossing recharge project was found to be economically unfeasible by the Army

---

<sup>1</sup> HDR. 1994. Guadalupe - San Antonio River Basin Recharge Enhancement Study - Phase II Preliminary Feasibility Assessment Proposal. HDR Engineering, Inc. Austin, Texas.

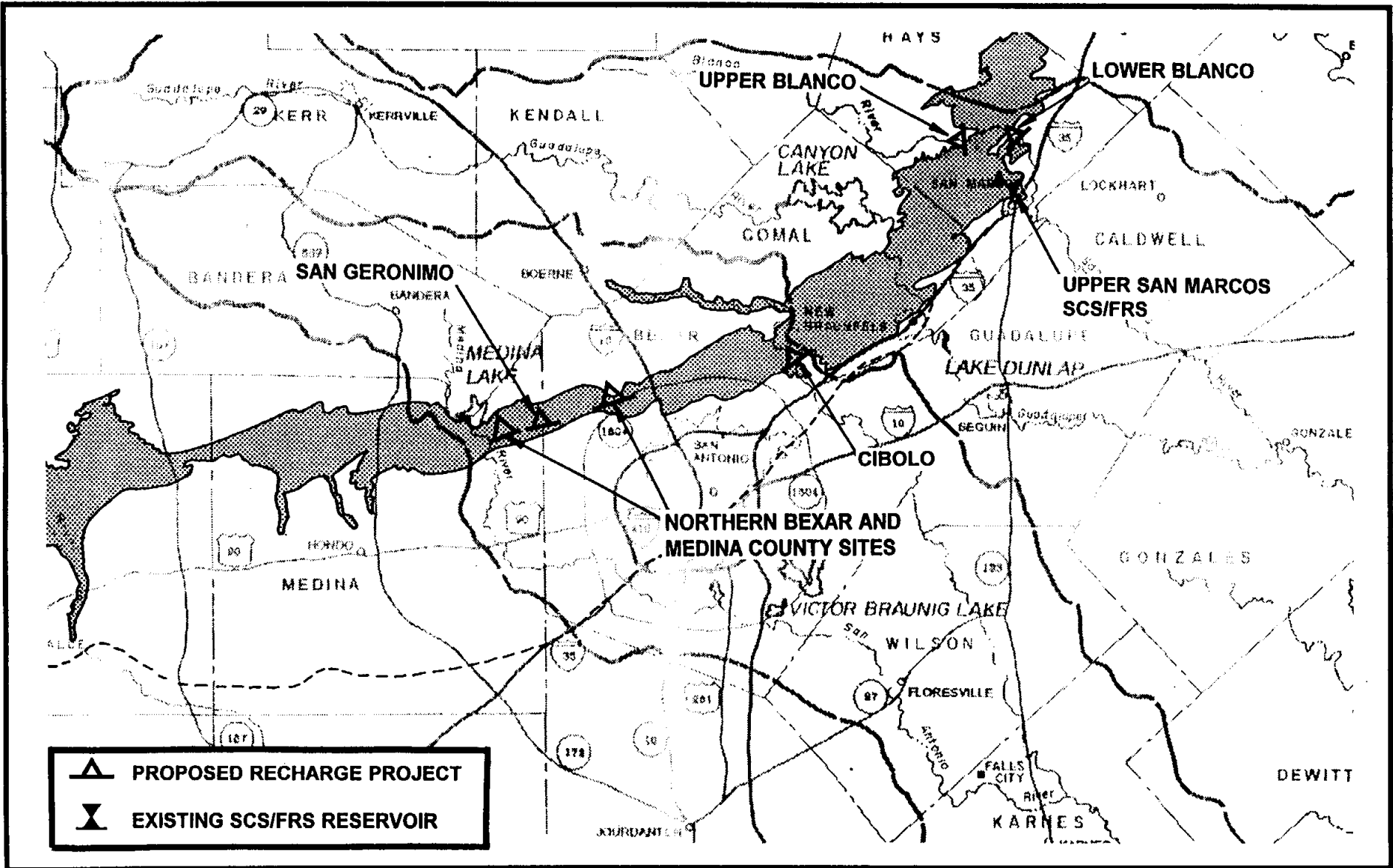

Source: HDR Engineering Inc., Austin, Texas



Figure 1 Location of Potential Recharge Enhancement Projects  
 Guadalupe - San Antonio River Basin  
 Recharge Enhancement Study Feasibility Assessment

**Paul Price Associates, Inc.**

ECOLOGY, WATER QUALITY, CULTURAL RESOURCES, PLANNING

Corps of Engineers (USCE) in 1979 and placed in a deferred category.<sup>2</sup> The incorporation of environmental studies and mitigation activities into the development of a proposed project generally results from the necessity to obtain the state and federal permits needed for project activities to go forward. With respect to the five recharge enhancement sites, regulations that will require environmental compliance include the Clean Water Act (33 USC 1344), the Endangered Species Act (16 USC 1531 *et seq*), and portions of the Texas Water Code involving water rights permits. Section 404 of the Clean Water Act prohibits the discharge of dredged or fill material into the waters of the United States, including adjacent wetlands, without a permit from the U.S. Army Corps of Engineers. Although some of the recharge project sites may not contain significant amounts of jurisdictional wetland, a 404 permit will be required because even intermittent streams are considered as waters of the United States unless the affected reach is "above the headwaters". Headwaters are generally defined as the point at which discharge averages less than 5 cfs (33 CFR 330.5 [a] [26] [I]).

In addition to environmental compliance, the developers of the project will also have to ensure compliance with federal laws and regulations that govern the protection of significant cultural resources. Before the U.S. Army Corps of Engineers will issue a Section 404 permit for the development of the reservoir sites, significant cultural resources located within the maximum flood pool elevation of each site will need to be identified and mitigated in accordance with 36 CFR 800, 36 CFR 60, and 36 CFR 79. This generally involves a three phase process which begins with an archeological survey to identify, record, and assess cultural resource properties within the proposed reservoir area (maximum flood pool elevation). Following the survey each cultural property is assessed regarding its significance and potential of being listed on the National Register of Historic Places (NRHP). This generally involves the execution of scientific excavations at those cultural properties that were determined during the survey to have potential significance and potential eligibility for the NRHP. Once cultural properties are determined to be eligible for the NRHP, they must be mitigated either through protection or must undergo scientific data recovery. After each phase of the process a report containing eligibility recommendations is presented to the USCE who consults with the State Historic Preservation Officer regarding the eligibility determinations of all cultural properties recorded and evaluated. Both agencies generally submit comments, and in cases where conflicting comments occur, the comments of the USCE preside.

---

<sup>2</sup> HDR. 1993. Guadalupe - San Antonio River Basin Recharge Enhancement Study, Volume I - Executive Summary. HDR Engineering, Inc and Espey, Huston and Associates, Inc. Austin, Texas. September 1993.



The proposed reservoirs are located in the Guadalupe - San Antonio River Basin along the southeastern edge of the Edwards Plateau in the counties of Medina, Bexar, Comal, and Hays (Figure 1). Strategies to enhance flow to the Edwards Aquifer capitalize on two characteristics of the recharge zone. First, most of the recharge occurs during runoff from heavy rains that can exceed maximum natural recharge possible and contribute to downstream flow. Second, most of the time streambeds in the recharge zone are dry and flow onto the recharge zone is well below maximum recharge amounts. Slowing the course of water over the recharge zone in order to increase the amount of time water remains there would increase recharge to the aquifer. Previous studies have considered two types of recharge enhancement structures. Type 1 recharge structures were designed to impound water upstream from the recharge zone and release this for recharge during times of lower flow. Type 2 recharge enhancement structures were designed to impound water directly over the recharge zone. Either method would increase the amount of time water remained over the recharge zone and thereby enhance recharge to the aquifer.

## 1.2 Methods and Materials

Proposed project areas were delineated by HDR Engineering, Inc., and field surveys were conducted on 2-3 August 1994 and 12 September 1995 to look for critical environmental features and to aid the interpretation of topographic maps and aerial photographs. Land uses, habitat types and values, and wetland occurrences within each project area were identified and evaluated using information from a variety of sources including Texas Natural Resources Information System's aerial photography and map database, Texas Parks and Wildlife Department, Resource Protection Division's data and mapping files for endangered, protected and sensitive resources, the U.S. Fish and Wildlife Service's National Wetland Inventory (NWI) maps, the Edward's Aquifer Research and Data Center, the Nature Conservancy, Bat Conservation International, and the Cave Conservancy. This data, including the locations of bat caves, state natural areas, potential wetland areas, and site reports of protected species is recorded on 7.5 minute quadrangles maintained at Paul Price Associates, Inc.

## 2.0 REGIONAL SETTING

The proposed project area is located in central Texas at the eastern boundary of the "Texas Hill Country" within the counties of Bexar, Comal, Hays, and Medina (Figure 1). The four counties lie in a northeast to southwest direction and are similar with respect to the regional characteristics discussed below.

## 2.1 Land and Climate

The Edward's Plateau comprises about 24,000,000 acres of the "Hill Country" in west-central Texas. The soils are usually thin and underlain by Edward's and Glen Rose limestones or caliche on the Plateau proper. The Edward's limestones that cap the plateau were formed about 140 million years ago by the deposition of shells and corals during the early to late Cretaceous Period when central Texas lay under a shallow, tropical sea. After the recession of the sea, geologic events about 15 million years ago uplifted the area, exposing the porous Edward's limestones. The same geologic events that uplifted the Edward's Plateau also created the Balcones Escarpment along the eastern and southern margins of the plateau. The escarpment forms the boundary between the Blackland Prairies to the east and the South Texas Plains to the south.

Annual temperatures in Hays, Comal, Bexar, and Medina Counties typically average in the upper 60's.<sup>3</sup> The number of days with highs of 90's (or above) exceeds 100 for all four counties and the number of days with temperatures of freezing ranging from 23 (Bexar County) to 38 (Hays County). Average annual precipitation increases from Medina to Hays County and ranges from 28.5 inches to 34.3 inches with peaks typically occurring in late spring and early fall. Winters in the region are typically mild and dry with freezing temperatures occurring only on about a third of the nights during the season. Summers are hot with little variation in day-to-day temperatures. Spring and fall are typically pleasant and characterized by mild days and cool nights.

## 2.2 Habitats and Biogeography

Habitat types present and land uses in the project area reflect its location at the boundaries of a plateau, plain (in Medina County), and prairie (in Bexar, Comal and Hays Counties).<sup>4</sup> The Balcones Fault Zone divides the Central Texas Plateau from the rolling to hilly Blackland Prairies and the smoother Southern Texas Plains (Figure 2). These ecoregions are defined based on the hypothesis that ecosystems and their components display regional patterns that are reflected in spatially variable combinations of causal factors such as climate, soils and geology, vegetation, and physiography.<sup>5</sup> The vegetation of the Central Texas Plateau, northwest of the Balcones Escarpment, is described as tablelands with moderate relief, plains with hills and open high hills

---

<sup>3</sup> NFIC. 1987. The Climates of Texas Counties. National Fibers Information Center. The University of Texas, Austin, Texas.

<sup>4</sup> Gould, F.W. 1962. Texas Plants - A checklist and Ecological Summary. Texas Agricultural Experiment Station. MP-585.

<sup>5</sup> Omernik, J.M. 1987. Ecoregions of the Conterminous United States. *Annals of the Association of American Geographers*. 77:118-125.

covered with a juniper/oak or mesquite/oak savannah. The Texas Blackland prairies, to the east of the Balcones Escarpment, are characterized by irregular grassland plains or tablelands of juniper/oak savannah and mesquite/oak savannah. In contrast, the Southern Texas Plains, south of the Balcones Escarpment, are smooth to irregular plains of mesquite/acacia or mesquite/live oak savannah. The divisions between and descriptions of these different ecoregions compare favorably to the vegetational areas of Texas.<sup>6</sup> The Central Texas Plateau ecoregion is comparable to the Edwards Plateau vegetational area, the Texas Blackland Prairies ecoregion to the Blackland Prairies vegetational area, and the Southern Texas Plains ecoregion to the South Texas Plains vegetational area (Figure 3).

### Edwards Plateau

The Edwards Plateau is a deeply dissected, rapidly drained rocky plain with broad, flat or undulating divides (Figure 2). The Edwards Plateau is underlain by horizontally bedded hard to soft dolomitic limestone and marl from shallow, marine Cretaceous sediments. The Edwards limestone is a cavernous forming limestone with embedded dolomite and chert. Surfaces are typically a plateau bordered by scarps with subsurface caverns of the upper Edwards Aquifer. The shallow and stony soils are formed in limestone and marl in long ridges. Deeper calcareous, clayey soils are found in stream and creek valleys.<sup>7</sup> The predominantly shallow soils are underlain by limestone and caliche. The Plateau's vegetation has historically been grassland or open savannah-type plains with tree or brushy species found along rocky slopes and stream bottoms.

Throughout the more savannah-type plains of the Edward's Plateau, brush species are generally considered as "invaders", with the climax stages composed of grassland. Within this area, the steeper canyon slopes have historically supported a dense oak-Ashe juniper thicket. The most important climax grasses of the Plateau include switchgrass, several species of bluestems and grammas, Indian grass, Canada wild-rye (*Elymus canadensis*), curly mesquite (*Hilaria berlanderi*), and buffalograss (*Buchloe dactyloides*). The rough, rocky areas typically support a tall or mid-grass understory and a brush overstory complex consisting primarily of live oak (*Quercus virginiana*), Texas oak (*Q. buckleyi*), shinnery oak (*Q. havardii*), Ashe juniper (*Juniperus ashei*), and mesquite (*Prosopis glandulosa*).

---

<sup>6</sup> Gould, F.W. 1975. *The Grasses of Texas*. Texas A&M University Press. College Station, Texas.

<sup>7</sup> Soil Conservation Service. 1983. *Soil Survey of Williamson County, Texas*. U.S. Department of Agriculture.

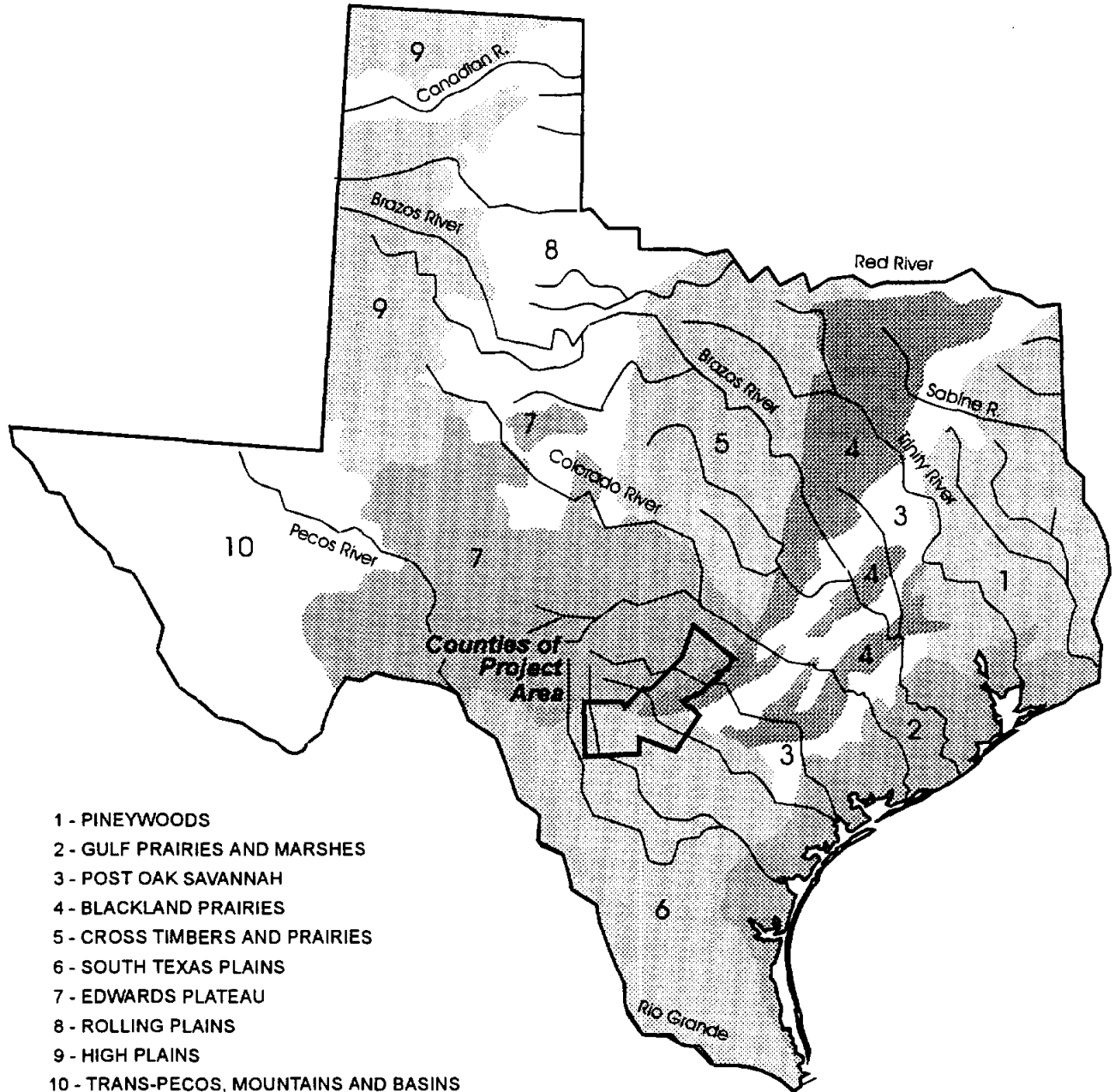

- 1 - PINEYWOODS
- 2 - GULF PRAIRIES AND MARSHES
- 3 - POST OAK SAVANNAH
- 4 - BLACKLAND PRAIRIES
- 5 - CROSS TIMBERS AND PRAIRIES
- 6 - SOUTH TEXAS PLAINS
- 7 - EDWARDS PLATEAU
- 8 - ROLLING PLAINS
- 9 - HIGH PLAINS
- 10 - TRANS-PECOS, MOUNTAINS AND BASINS

Map Source: Gould, F.W. 1962. The Grasses of Texas.  
Texas A&M University Press, College Station, Texas.

200 MILES  
300 KILOMETERS

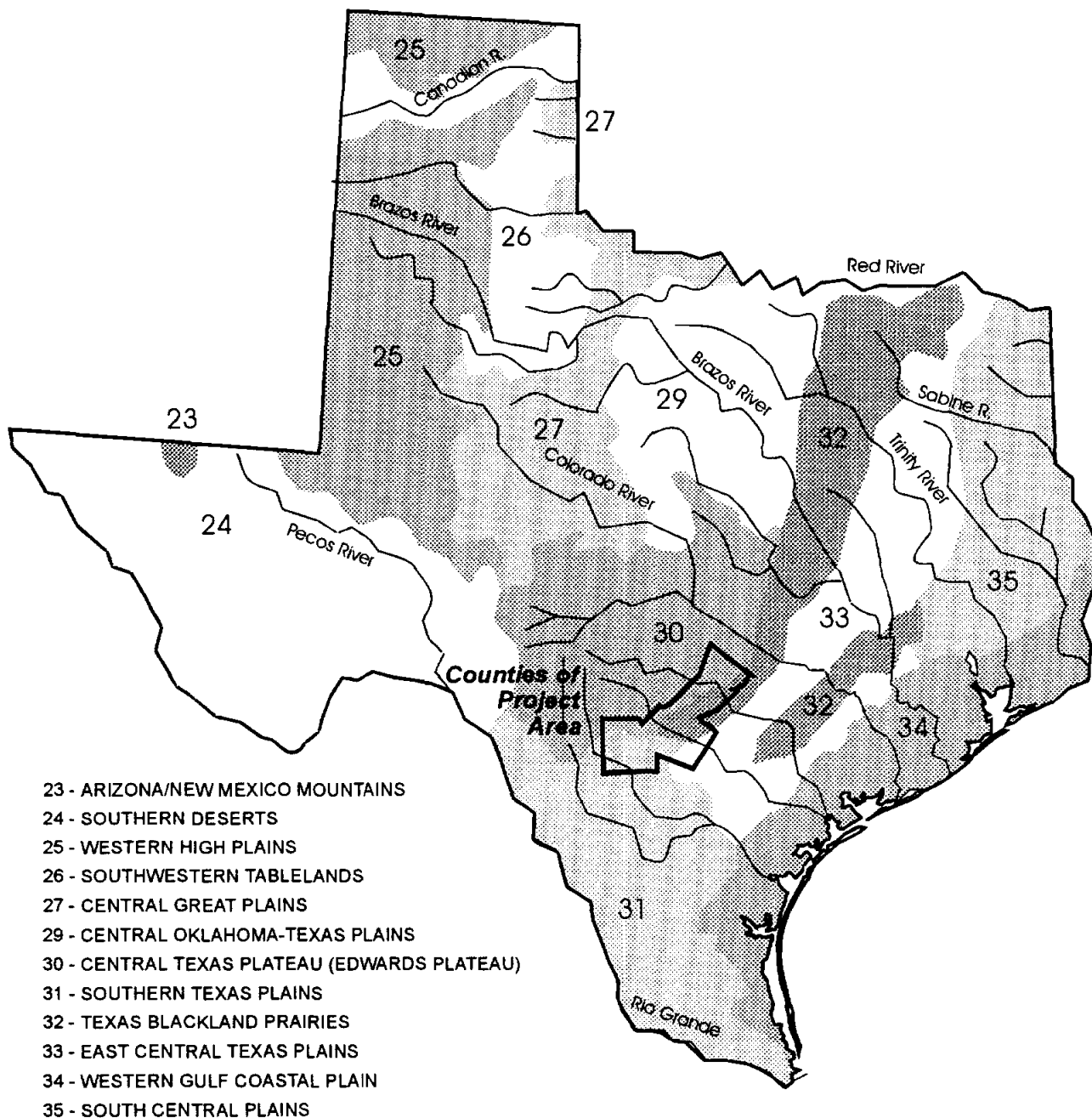

Figure 3

Vegetational Areas of Texas  
Guadalupe-San Antonio River Basin  
Recharge Enhancement Study  
Medina, Bexar, Comal  
and Hays Counties, Texas

Paul Price Associates, Inc.

ECOLOGY, WATER QUALITY, CULTURAL RESOURCES, PLANNING



Map Source: Omernik, J.M. 1987. Ecoregions of the Conterminous United States. Annals of the Association of American Geographers 77:111-125.

200 MILES  
300 KILOMETERS



Figure 2

Ecoregions of Texas  
Guadalupe-San Antonio River Basin  
Recharge Enhancement Study  
Medina, Bexar, Comal  
and Hays Counties, Texas

Paul Price Associates, Inc.

ECOLOGY, WATER QUALITY, CULTURAL RESOURCES, PLANNING

Mesic stream bottom habitats were created as rivers, fed by numerous springs that cut canyons through the plateau, especially near its margins, formed unique niches for a variety of plant species. Because of the many large canyons and rugged terrain, this area is botanically of much interest and has consequently been visited by many botanical collectors. The ferns, as well as many of the flowering plants which are common to the area, are primarily lithophilous ("rock-loving"), and are represented primarily by various species of lipferns (*Cheilanthes* spp.), cloak-ferns (*Notholaena* spp.), and cliff brakes (*Pellaea* spp.). Columbine (*Aquilegia canadensis*), and endemic species such as anemone (*Anemone edwardsianus*) and wand butterfly-bush (*Buddleja racemosa*) are also present. These plants are sometimes found together with species such as mockorange (*Philadelphus* spp.), American smoke-tree (*Cotinus americana*), spicebush (*Benzoin aestivale*), and the endemic silver bells (*Styrax platanifolia* and *S. texana*) on large boulders and in shaded ravines.

### Balcones Escarpment

The Balcones Escarpment is the southern and eastern margin of the uplifted Edwards Plateau (Figure 2). The limestones capping the Edwards Plateau were formed by deposition of the calcareous shells of marine invertebrates about 140 million years ago when Texas was covered by a shallow sea. The recession of the sea and uplifting exposed the porous Edwards limestones and created the Balcones Fault at the plateau's eastern and southern margins. At the southern and southeastern edges of the Edwards Plateau in the Counties of Medina, Bexar, Comal, and Hays the Balcones Escarpment forms a distinct boundary between the plateau and the South Texas Plains and Blackland Prairies (Figure 2). The Balcones Escarpment is characterized by a complex of porous, faulted limestones in stream beds, sinkholes, and fractures which allow substantial volumes of water to flow into the Edwards Aquifer.<sup>8</sup> The extensive faulting which occurs throughout the Edwards formation, underlying the Edwards Plateau and the Balcones escarpment, is an important feature in the development of local physiographic features, groundwater aquifers and springs. Solution, or karst features, including sinkholes, caves, and smaller cavities along bedding planes and fractures are found throughout the Edwards formation, and springs commonly occur at its base. Streamflows contribute significantly to the recharging of the Edwards Aquifer,<sup>9</sup> which feeds springs that provide habitat for a number of endemic and endangered species. The ecotone, or ecological transition zone between the Edwards Plateau and the Blackland Prairie forms unique habitats favorable to a number of rare and protected species. The isolated springs

---

<sup>8</sup>Caran, C.S. 1982. Lineament Analysis and Inference of Geologic Structure.

<sup>9</sup>United States Geological Survey. 1989. Compilation of Hydrologic Data for the Edwards Aquifer, San Antonio Area, Texas, 1988. With 1934-1988 Summary, Bulletin 48, November 1989.

and caves which are common along the escarpment favor endemism in which organisms become narrowly adapted to the local environment. In the most extreme cases an entire species may be limited to a particular spring or cave. In addition to containing many endemic species, the Balcones Escarpment delineates the conspicuous changes in climate, vegetation, and animal life which occur with the transition from the Edwards Plateau to the Blackland Prairies to the east and the Southern Texas Plains to the south.

### Blackland Prairie

The Blackland Prairie vegetational area (Figure 3) is extensively cultivated, and its heavily productive and fertile soils are fairly uniform, dark-colored clays interspersed with some gray, acid, sandy loams.<sup>10</sup> The topography of this area is gently rolling, and marked by numerous hills with rounded slopes. The Blackland Prairie, which is broken by tree-lined tributaries of rivers such as the Brazos and Colorado, is considered a true prairie, marking some of the southern-most reaches of the Great Plains.

As a true prairie, grasses constitute a large portion of the native flora in the Blackland Prairie. Little bluestem (*Schizachyrium scoparium* var. *frequens*) is the climax dominant of this vegetational area. Other important grasses include big bluestem (*Andropogon gerardii*), Indian grass (*Sorghastrum nutans*), switchgrass (*Panicum virgatum*), sideoats grama (*Bouteloua curtipendula*), hairy grama, (*Bouteloua hirsuta*), tall dropseed (*Sporobolus asper*), silver bluestem (*Bothriochloa saccharoides* var. *torreyana*), and Texas wintergrass (*Stipa leucotricha*). Under heavy grazing, Texas wintergrass, buffalograss (*Buchloe dactyloides*), Texas grama (*Bouteloua rigidisetata*), smutgrass (*Sporobolus indicus*), and many annuals increase within or invade these areas. Mesquite has invaded hardland sites of the southern portion of the Blackland Prairies. Numbers of post oak (*Q. stellata*) and blackjack oak (*Q. marilandica*) increase on the medium-to-light-textured soils. Although classified as a true prairie, the Blackland Prairie has substantial amounts of timber, especially along the streams that traverse it. Common tree species include a variety of oaks, pecan (*Carya illinoensis*), cedar elm (*Ulmus crassifolia*), bois d'arc (*Maclura pomifera*), and mesquite. There is evidence that the brush and tree densities in this area have increased dramatically from the virgin condition.<sup>11</sup>

---

<sup>10</sup> Schmidly, D.J. 1983. Texas Mammals East of the Balcones Fault Zone. Texas A&M University Press. College Station, Texas.

<sup>11</sup> Gould, F.W. 1975. The Grasses of Texas. Texas A&M University Press. College Station, Texas.

## South Texas Plains

In Medina County, the Balcones Escarpment divides the Edwards Plateau and the South Texas Plains, which are also termed the Rio Grande Plains, or Tamaulipan Brushlands (Figures 2 and 4).<sup>12</sup> The topography of the South Texas Plain is level to rolling, and the land is dissected by arroyos or by streams flowing into the Rio Grande and the Gulf of Mexico. It is characterized by open prairies and a growth of mesquite, grangeno (*Celtis pallida*), cacti (*Opuntia* spp.), clepe (*Ziziphus obtusifolia*), coyotillo (*Karwinskia Humboldtiana*), guayacan (*Porlieria angustifolia*), white brush (*Aloysia gratissima*), brasil (*Condalia Hookeri*), bisbirinda (*Castela texana*), cenizo (*Leucophyllum* spp.), huisache (*Acacia farnesiana*), catclaw (*A. greggii*), black brush (*A. rigidula*), guajillo (*A. Berlandieri*), and other small trees and shrubs which are found in varying degrees of abundance and composition.<sup>13</sup> Historically the area was grassland or savanna type climax vegetation, however, long-continued heavy grazing and other factors have resulted in a general change to a cover of shrubs and small trees. Among the several species of shrubs and trees that have made dramatic increases are mesquite, live oak, post oak (*Q. stellata*), and *Acacia* spp.<sup>14</sup> Blair described the Tamaulipan province of Texas as being characterized by predominantly thorny brush vegetation.<sup>15</sup> This brushland stretches from the Balcones fault zone southward into Mexico. A few species of plants account for the bulk of the brush vegetation and give it a characteristic aspect throughout the Tamaulipan Biotic Province of Texas. The most important of these include: mesquite, lignum vitae (*Porlieria angustifolia*), cenizo (*L. texanum*), white brush, prickly pear (*Opuntia lindheimeri*), tasajillo (*O. leptocaulis*), *Condalia* sp., and *Castela* sp. The brush species on sandy soils differ from those on clay soils. Mesquite, in an open stand and mixed with various grasses, is characteristic of sandy areas whereas clay soils usually have all of the species listed above, including mesquite. Although rangeland predominates throughout the South Texas Plains / Tamaulipan Brushland, land use also includes significant acreages of croplands.

### 2.3 Edwards Aquifer

The Balcones Escarpment is characterized by a complex of porous, faulted limestones in stream beds, sinkholes, and fractures which allows substantial volumes of water to flow into the Edward's

---

<sup>12</sup> Blair, F.W. 1950. The Biotic Provinces of Texas. Texas Journal of Science 2(1):93-117.

<sup>13</sup> Correll, D.S. and M.C. Johnston. 1979. Manual of the Vascular Plants of Texas. The University of Texas at Dallas. Dallas, Texas.

<sup>14</sup> Gould, F.W. 1975. The Grasses of Texas. Texas A&M University Press. College Station, Texas.

<sup>15</sup> Blair, F.W. 1950. The Biotic Provinces of Texas. Texas Journal of Science 2(1):93-117.



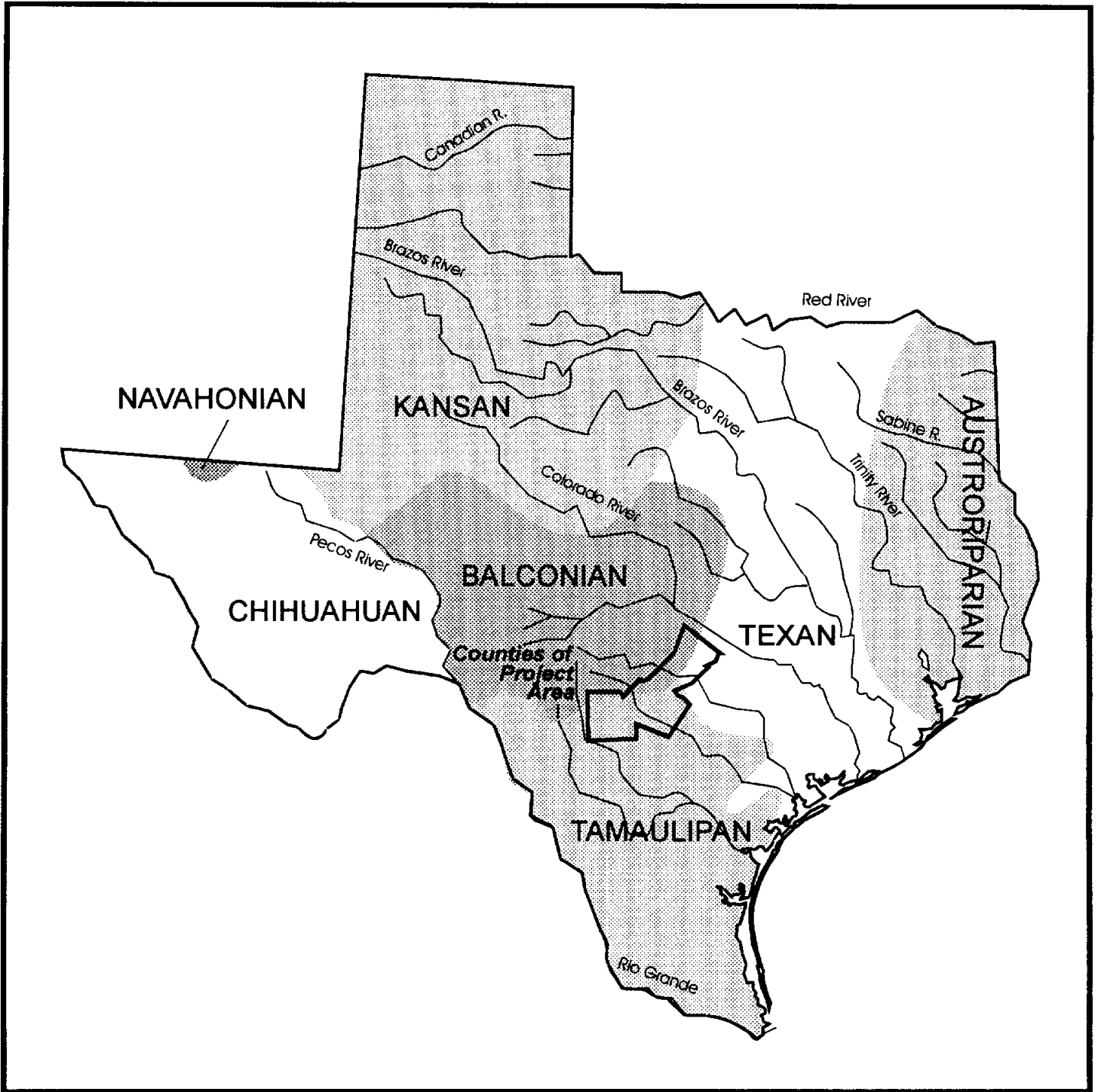

Map Source: Blair, F.W. 1950. The Biotic Provinces of Texas.  
 Texas Journal of Science 2(1):93-117.

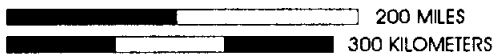

Figure 4

Biotic Provinces of Texas  
 Guadalupe-San Antonio River Basin  
 Recharge Enhancement Study  
 Medina, Bexar, Comal  
 and Hays Counties, Texas

**Paul Price Associates, Inc.**

**ECOLOGY, WATER QUALITY, CULTURAL RESOURCES, PLANNING**

Aquifer.<sup>16</sup> The Edward's Aquifer recharge zone has a surface area of about 1,500 square miles in Uvalde, Kinney, Medina, Bexar, Hays, and Comal Counties. Streamflows contribute significantly to recharge of the Edwards Aquifer<sup>17</sup> which supplies water to customers in the City of San Antonio and numerous other users. Additionally, the Edwards Aquifer feeds springs which provide habitat for several endemic, endangered species.<sup>18</sup> The karst formations making up the Edwards and associated limestones constitute the Edwards Aquifer. The aquifer has three basic zones: the drainage or catchment zone, the recharge zone, and the artesian zone (Figure 5). Water is supplied to the aquifer by rainfall and streamflow on the porous limestones and thin, rock soils capping the Edwards Plateau catchment zone. Percolation through the Edwards limestone is stopped by relatively impermeable layers in the older Glen Rose formation. Where rivers flowing across the plateau have carved deep canyons and exposed the base of the Edwards Limestone, spring fed streams arise and flow south and eastward over the impermeable older formations to the recharge zone.

Significant recharge occurs along the Balcones fault zone through karst features in limestone stream beds, sinkholes, and fractures.<sup>19</sup> About 75 percent of the recharge volume that enters the aquifer is stream channels.<sup>20</sup> Because faulting is most extensive along the western portions of the escarpment, most of the recharge occurs in the Nueces River, Dry Frio River, Frio River, and Sabinal Creek basins. It has been estimated that these rivers account for an average annual recharge volume of 342,100 acre-feet out of a total annual recharge rate of 604,500 acre-feet<sup>21</sup>

In the artesian zone, the aquifer is confined by relatively impermeable zones in the Glen Rose Formation below and a layer of impermeable Del Rio Clay above. The catchment and artesian zones of the main portion of the Edwards Aquifer together form a crescent-shaped area extending from Brackettville in Kinney County in the west, to the eastern tip near Kyle in Hays County (Figure 5). To the north, the Edwards Aquifer consists of hydrologically isolated units, such as Barton Springs in Austin, Texas. The width of these isolated units varies from about five to 30

---

<sup>16</sup> Caran, C.S. 1982. *Lineament Analysis and Inference of Geologic Structure*.

<sup>17</sup> United States Geological Survey. 1989. *Compilation of Hydrologic Data for the Edwards Aquifer, San Antonio Area, Texas, 1988. With 1934-1988 Summary, Bulletin 48, November 1989.*

<sup>18</sup> HDR. 1994. *Op. Cit.*

<sup>19</sup> Caran, C.S. 1982. *Lineament Analysis and Inference of Geologic Structure*.

<sup>20</sup> United States Geological Survey. 1989. *Compilation of Hydrologic Data for the Edwards Aquifer, San Antonio Area, Texas, 1988. With 1934-1988 Summary, Bulletin 48, November 1989.*

<sup>21</sup> United States Geological Survey. 1989. *Compilation of Hydrologic Data for the Edwards Aquifer, San Antonio Area, Texas, 1988. With 1934-1988 Summary, Bulletin 48, November 1989.*

Map Base from Edwards Underground Water District publication

TDELL:JOB850148/FRI:EDS:CDR4-2&-96

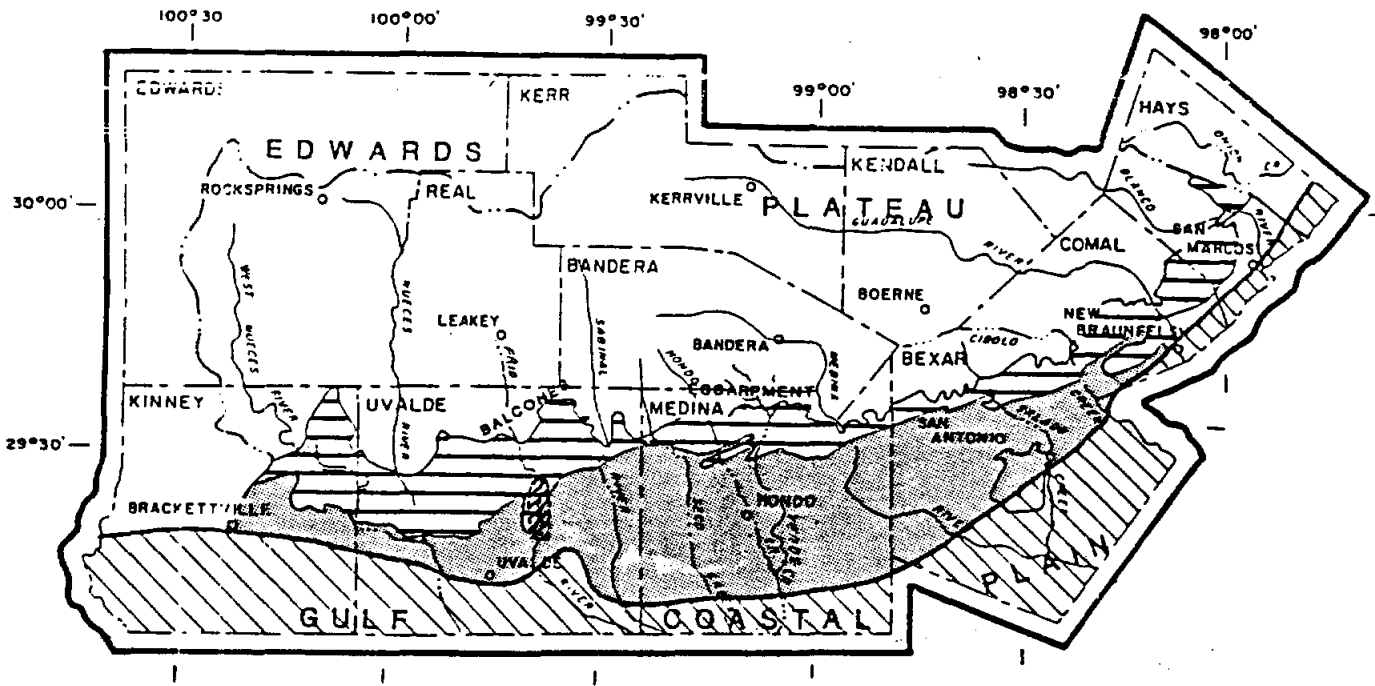

### Edwards Aquifer and Catchment Area

- ARTESIAN AREA WITHIN FRESH WATER ZONE—Edwards Aquifer primarily under artesian conditions.
- APPROXIMATE RECHARGE ZONE WITHIN FRESH WATER ZONE—Edwards Aquifer is under water table conditions.
- "BAD WATER" LINE—Separates fresh water zone to the north from the saline water zone to the south.
- SALINE WATER ZONE
- DRAINAGE DIVIDE
- INTERMITTENT REACH OF STREAM
- CATCHMENT AREA

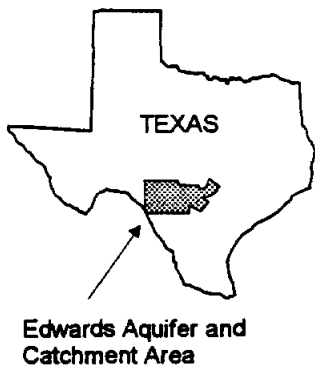

Figure 5

Edwards Aquifer and Catchment Area  
 San Antonio - Guadalupe  
 Recharge Enhancement Study  
 Bexar, Comal, Hays and Medina Counties

**Paul Price Associates, Inc.**

**ECOLOGY, WATER QUALITY, CULTURAL RESOURCES, PLANNING**

miles. Water in the artesian zone exhibits progressively increased levels of dissolved minerals and lower dissolved oxygen concentrations toward the south and east as the aquifer plunges deeper into the earth and circulation slows. The indistinct boundary is termed the "bad water" line.

The Edwards Aquifer transfers significant quantities of water between river basins, primarily in a west to east direction. For example, surface water captured in the western catchment zone of the Nueces River Basin contributes to river flows in the eastern area of the artesian zone, such as the San Antonio and Guadalupe Rivers. About 64 percent of the Edwards Aquifer recharge is estimated to occur in the river basins west of San Antonio. Most of the spring flow from the Edwards Aquifer emerges in the Guadalupe River basin, much of it being discharged from Comal and San Marcos Springs. The San Marcos Springs have been crucial to Guadalupe River flows because, unlike Comal Springs which are located at a higher aquifer elevation, the San Marcos Springs have never ceased flowing. The San Marcos springs have the greatest flow dependability and environmental stability of any spring system in the southwestern United States. Constancy of its spring flow is key to the unique ecosystem found in the uppermost San Marcos River.

The subterranean aquatic habitats associated with the Edwards Aquifer support a diverse ecosystem. The aquifer also provides habitat for several endangered subterranean species and is critical for the maintenance of spring habitats containing several other endemic, endangered species (see Section 2.5, Protected and Important Species). The Edwards Aquifer is the only underground aquatic habitat in Texas in which vertebrate species live with populations of both vertebrates and macroinvertebrates found at depths ranging from 190 to 2,000 feet in the artesian parts of the aquifer.<sup>22</sup> Several Edwards springs, including small ones found near the potential reservoir sites, support populations of the Texas Salamander (*Eurycea neotenes*) which is a rare species that is restricted to and dependent on spring habitats. This type of adaptation is common in constant temperature spring habitats and can result in endemism where an entire species may be restricted to a particular spring.

#### 2.4 Guadalupe - San Antonio River Basin

The Academy of Natural Sciences of Philadelphia (ANSP) conducted studies of the macroinvertebrate fauna of the Guadalupe River from 1949 to 1989.<sup>23</sup> Six sites in Victoria

---

<sup>22</sup> Edwards, RJ; Longley, G; Moss, R; Matthews, R and B Stewart. 1989. A Classification of Texas Aquatic Communities with Special Consideration Toward the Conservation of Endangered and Threatened Taxa. Texas Journal of Science 41(3):231-240.

<sup>23</sup> ANSP. 1991. Chemical and Biological Studies on the Guadalupe River, Texas 1949-1989. Report No. 91-9 The Academy of Natural Sciences of Philadelphia. Philadelphia, Pennsylvania.

County were surveyed in 1949, 1950, 1952, 1962, 1966, 1973 and 1989. In terms of species richness and abundance, populations of molluscs and crustaceans have remained constant over the sampling period. Dominant species of molluscs and crustaceans include Asiatic clam (*Corbicula fluminea*), golden orb (*Quadrula aurea*), Texas lilliput (*Toxolasma texasensis*), grass shrimp (*Palaemonetes* spp.), crayfish (*Procambarus clarkii*), and blue crab (*Callinectes sapidus*).

Kuehne<sup>24</sup>, Hubbs<sup>25</sup>, and Lee et al.<sup>26</sup>, when considered together, provide a comprehensive list of fishes likely to inhabit the San Antonio and Guadalupe Rivers where appropriate habitats occur. Hubbs, et al.<sup>27</sup> provides an inventory and bibliography dealing with the fishes of Texas. In addition to studying macroinvertebrate communities, ANSP has studied fish communities of the Guadalupe River periodically since 1949. Based on increasing capture records, populations of threadfin shad (*Polydactylus* spp.), green sunfish (*Lepomis cyanellus*), longear sunfish (*L. megalotis*), and warmouth (*L. gulosus*) appear to be increasing in the Guadalupe River. Introduced species including Mexican tetra (*Astyanax mexicanus*), orangespotted sunfish (*L. humilis*), sailfin molly (*Poecilia latipinna*), white crappie (*Pomoxis annularis*), black crappie (*P. nigromaculatus*), and white bass (*Morone chrysops*) also appear to be increasing in abundance.

The Guadalupe-San Antonio Estuary includes a system of freshwater, brackish, and saltwater marshes.<sup>28</sup> Many plant species found in marshes can tolerate a wide range of salinities and may occur in more than one type of marsh. Other plants may have narrower niche requirements and can be characteristic of a particular type of marsh habitat. Drier, high marshes are characterized by species such as gulf cordgrass (*Spartina spartinae*), paspalum (*Paspalum* spp.), smartweed (*Polygonum* spp.), panic grass (*Panicum* spp.), sea ox-eye daisy (*Borrchia frutescens*), beak rush (*Rhynchospora macrostachya*), sedge (*Fimbristylis* spp.), Mexican devil-weed (*Aster spinosus*), saltmeadow cordgrass (*Spartina patens*), scattered bulrush (*Scirpus* spp.), spike rush, and flatsedge. Wetter, low marshes are characterized by cattail (*Typha* spp.), three-square bulrush (*Eleocharis* spp.), flatsedge (*Cyperus* spp.), water hysop (*Bacopa monnieri*), rush (*Juncus* spp.), water primrose (*Ludwigia* spp.), arrowhead (*Sagittaria* spp.), and paspalum (*Paspalum lividum*).

---

<sup>24</sup> Kuehne, R.A. 1955. Stream Surveys of the Guadalupe and San Antonio Rivers. IF Report No. 1. Texas Game and Fish Commission. Austin, Texas.

<sup>25</sup> Hubbs, C. 1982. A Checklist of Texas Freshwater Fishes. Technical Series No. 11:1-12. Texas Parks and Wildlife Department, Austin, Texas.

<sup>26</sup> Lee, S. L., C.R. Gilbert, C.H. Hocutt, R.E. Jenkins, D.E. McAllister, J.R. Stauffer, Jr. 1980. Atlas of North American Freshwater Fishes. Publ. No. 1980-12 of the North Carolina Biological Survey.

<sup>27</sup> Hubbs, C., J.D. McEachran and C.R. Smith. 1994. Freshwater and Marine Fishes of Texas and the Northwestern Gulf of Mexico. The Texas System of Natural Laboratories, Inc., Austin, Texas.

<sup>28</sup> Longley, William. 1994. Freshwater Inflows to Texas Bays and Estuaries: Ecological Relationships and Methods for Determination of Needs. Texas Parks and Wildlife Department, Austin, Texas.

Shrubs such as rattlebush (*Sesbania drummondii*), retama (*Parkinsonia aculeata*), and black willow tend to be scattered around the margins of freshwater marshes.

Average inshore catch for all species in the Guadalupe-San Antonio Estuary for the period 1962-1976 exceeded 2.3 million pounds, the third highest out of eight estuaries in Texas. Shrimp accounted for over 90 percent of the bay harvest weight. The shellfish component consists of white shrimp (*Penaeus setiferus*), brown shrimp (*P. aztecus*), blue crab, and eastern bay oyster (*Crassostrea virginica*). The finfish component consists of croaker (*Micropogon undulatus*), spotted seatrout (*Cynoscion nebulosus*), red drum (*Sciaenops ocellata*), black drum (*Pogonias cromis*), sheepshead (*Archosargus probatocephalus*), mullet (*Mugil* sp.), gulf menhaden (*Brevoortia patronus*) flounder (*Paralichthys* sp.), and sea catfish (*Arius felis*).<sup>29</sup> Commercial harvesting of spotted sea trout and red drum has been banned since 1981.

The Guadalupe-San Antonio Estuary also supports a significant sport fishery. Texas Parks and Wildlife Department estimates that harvest of all fish species represents 380,000 fish totaling 420,000 pounds in a single year. Sixty percent of the sport fishery is accounted for by spotted sea trout. Red drum, southern flounder (*P. lethostigma*), black drum, and sand sea trout account for an additional 25 percent of the recreational harvest. Atlantic croaker (*Micropogonias undulatus*), gafftopsail catfish (*Barge marinus*), requiem shark (*Carcharhinidae*), and southern kingfish (*Menticirrhus americanus*) account for five percent of the recreational harvest.

The commercial and sport fish depend upon many estuarine species for survival. Spotted seatrout, southern flounder, and red drum depend on shrimp, pinfish (*Lagodon rhomboides*), menhaden, anchovy (*Anchoa* sp.), and mullet for food while many of the larval fish depend upon plankton, polychaete worms, and crustaceans for food. Shrimp feed on detritus, polychaetes, epiphytes, and plankton. Gizzard shad (*Dorosoma cepedianum*), striped and white mullet, gulf menhaden, bay anchovy, clams (*Rangia cuneata* and *R. flexuosa*), and eastern bay oyster represent ecologically important species that feed directly on detritus and plankton. Shrimp and small fishes such as pinfish, gulf killifish and longnose killifish (*Fundulus* spp.), sheepshead minnows (*Cyprinodon variegatus*), silversides (*Menidia* sp.), silver perch and juvenile fish are a significant source of food for higher level consumers such as red drum, herons, egrets, porpoise, and spotted sea trout.

---

<sup>29</sup> Ibid.

## 2.5 Protected and Important Species

Species considered by the U.S Fish and Wildlife Service under the Endangered Species Act (16 USC 1536) or Texas Parks and Wildlife Department to be endangered, and having some likelihood of occurring in Medina, Bexar, Comal, or Hays Counties are listed in Table 1. Of the Endangered/Threatened species most likely to be present, those most likely to be rare as a result of restrictive habitat requirements, and thus especially sensitive to habitat destruction, include the golden-cheeked warbler and black capped vireo.

The golden-cheeked warbler is the only species of bird that nests only in Texas. Its nesting range includes the eastern third of the Edwards Plateau. Golden-cheeked warblers require strips of bark from mature Ashe-junipers for nest building. Consequently, golden-cheeked warbler habitat is characteristically Ashe-juniper - oak woods with mature Ashe-juniper as a dominant. In the central part of the golden-cheeked warbler's range, including Comal and Hays Counties, Texas oak is important, however, at the extremes of the range other oak species are more prevalent. The Texas Natural Heritage Program reports occurrences of golden-cheeked warblers on several 7.5 minute quadrangle maps: North San Marcos, Texas (about 5 miles south of the proposed Lower Blanco Dam in Hays County), San Geronimo, Texas (on the Government Canyon reservoir site, about 4 miles north of the proposed San Geronimo Dam in Medina County). The regular nesting of golden-cheeked warblers in Friedrich Park, northern Bexar County, which has been included in several habitat studies<sup>30,31</sup> also serves to illustrate that preferred habitat may be found within project areas.

The black-capped vireo inhabits dry limestone hilltops, ridges, and slopes on the eastern and southern portions of the Edwards Plateau. However, its nesting range extends into the canyons of the Stockton Plateau to the west, and north into central Oklahoma. The most important feature for nesting black-capped vireos appears to be habitat structure rather than species composition. Preferred nesting habitat is characterized by a distinct two-storied structure of low dense brush (from the ground up to about 6 feet) with an open woodland overstory of oaks and juniper.

Black-capped vireo habitat is mid-successional, develops following fire or clearing, is sensitive to land use practices, and can be created using appropriate management practices. Probable

---

<sup>30</sup> Wahl, R; Diamond, D and D Shaw. 1990. The Golden-cheeked Warbler: A Status Review. Final Report Submitted to Ecological Services, U.S. Fish and Wildlife, Fort Worth, Texas.

<sup>31</sup> Ladd, C.G. 1985. Nesting habitat requirements of the Golden-cheeked Warbler. Master of Science Thesis, Southwest Texas State University, San Marcos, Texas. 65 p.

Table 1.

## Endangered, Threatened and Important Species for Bexar (BX), Comal (CM), Hays (HA) and Medina (MD) Counties, Texas

Common Name	Scientific Name	Habitat Preference	USFWS Listing	TPWD Listing	TOES Listing	Counties of Occurrence	Potential Occurrence
<b>MAMMALS:</b>							
Jaguarundi	<i>Felis yaguarondi</i>	Dense thorny thickets of South Texas	E <sup>1</sup>	E <sup>9</sup>	E <sup>8</sup>	CM	endemic
Frio Pocket Gopher	<i>Geomys texensis bakeri</i>	Deep, brown loamy sands or gravelly sandy loams	NL <sup>1,5</sup>	NL <sup>6</sup>	NL <sup>8</sup>	MD	endemic
Cave Myotis	<i>Myotis velifer</i>	Cave-dwelling; may also roost in rock crevices, old-buildings, and bridges	NL <sup>1,5</sup>	NL <sup>6</sup>	NL <sup>8</sup>	BX, HA	endemic
<b>AVES:</b>							
White-tailed Hawk	<i>Buteo albicaudatus</i>	Grasslands and coastal prairies	NL <sup>1,5</sup>	T <sup>9</sup>	T <sup>8</sup>	CM, MD	endemic
Zone-tailed Hawk	<i>Buteo albonotatus</i>	Arid scrub, pine-oak woodland; mountains of Trans-Pecos and western Edwards Plateau	NL <sup>1,5</sup>	T <sup>9</sup>	T <sup>8</sup>	BX, HA	transient
Mountain Plover	<i>Charadrius montanus</i>	Western plains; shortgrass prairies; Western Panhandle and Trans-Pecos	C <sup>5</sup>	NL <sup>6,9</sup>	NL <sup>8</sup>	HA	transient
Golden-cheeked Warbler	<i>Dendroica chrysoparia</i>	Woodlands with oak and mature juniper	E <sup>1</sup>	E <sup>9</sup>	T <sup>8</sup>	BX, CM, HA, MD	migratory
Reddish Egret	<i>Egretta rufescens</i>	Coastal wetland islands	NL <sup>1,5</sup>	T <sup>9</sup>	NL <sup>8</sup>	BX	transient
Peregrine Falcon	<i>Falco Peregrinus</i>	Open coastal areas	E (S/A) <sup>1</sup>	NL <sup>6,9</sup>	NL <sup>8</sup>	BX, CM, HA, MD	transient

<sup>1</sup> U.S. Fish and Wildlife Service Division of Endangered Species. U.S. listed vertebrate animal species index by lead region and status as of January 31, 1997. U.S. Fish and Wildlife Endangered Species Home Page.

<sup>2</sup> U.S. Fish and Wildlife Service Division of Endangered Species. U.S. listed invertebrate animal species index by lead region and status as of January 31, 1997. U.S. Fish and Wildlife Endangered Species Home Page.

<sup>3</sup> U.S. Fish and Wildlife Service Division of Endangered Species. U.S. listed flowering plant species index by lead region and status as of January 31, 1997. U.S. Fish and Wildlife Endangered Species Home Page.

<sup>4</sup> U.S. Fish and Wildlife Service Division of Endangered Species. U.S. listed Non-flowering plant species index by lead region and status as of January 31, 1997. U.S. Fish and Wildlife Endangered Species Home Page.

<sup>5</sup> Federal Register. February 28, 1996. 50 CFR Part 17. Review of plant and animal taxa that are candidates for listing as endangered or threatened species. Fish and Wildlife Service Division, U.S. Department of the Interior. Notice of Review.

<sup>6</sup> Texas Biological and Conservation Data System. Texas Parks and Wildlife Department, Endangered Resources Branch. County lists of Texas' special species. (Bastrop, Bell, Burlison, Burnet, Colorado, Fayette, Hays, Lee, Llano, Milam, Travis, Washington and Williamson Counties revised Jan. 13, 1997)

<sup>7</sup> Texas Organization for Endangered Species. August 1993. Endangered, threatened and watch lists of Texas plants. TOES Publication 9, third revision.

<sup>8</sup> Texas Organization for Endangered Species. January 1988. Endangered, threatened and watch lists of vertebrates of Texas. TOES Publication 6.

<sup>9</sup> Texas Biological and Conservation Data System. Texas Parks and Wildlife Department, Endangered Resources Branch. Species with Federal or Texas State Endangered or Threatened Status. Dec. 1996

<sup>10</sup> Texas Organization for Endangered Species. Sept. 1988. Invertebrates of Special Concern TOES Publication 7.



Common Name	Scientific Name	Habitat Preference	USFWS Listing	TPWD Listing	TOES Listing	Counties of Occurrence	Potential Occurrence
American Peregrine Falcon	<i>Falco peregrinus anatum</i>	Open Coastal areas	E <sup>1</sup>	E <sup>9</sup>	E <sup>8</sup>	BX, CM, HA	migratory
Arctic Peregrine Falcon	<i>Falco peregrinus tundris</i>	Open Coastal Plain	E (S/A) <sup>1</sup>	T <sup>9</sup>	T <sup>8</sup>	BX, CM, HA, MD	migratory
Whooping Crane	<i>Grus americana</i>	Coastal wetlands, Matagorda and Aransas Islands	E <sup>1</sup>	E <sup>9</sup>	E <sup>8</sup>	BX, CM, HA	transient
Bald Eagle	<i>Haliaeetus leucocephalus</i>	Large bodies of water with nearby roosting and nesting sites	T <sup>1</sup>	T <sup>9</sup>	E <sup>8</sup>	HA	migratory
Wood Stork	<i>Mycteria americana</i>	Coastal wetlands, dispersal	NL <sup>1,5</sup>	T <sup>9</sup>	T <sup>8</sup>	BX, HA, MD	endemic
Brown Pelican	<i>Pelecanus occidentalis</i>	Ocean, salt bays, and coastal areas	E <sup>1</sup>	E <sup>9</sup>	E <sup>8</sup>	BX, CM, HA, MD	transient
White-faced Ibis	<i>Plegadis chihi</i>	Bays, marshes, lakes, ponds; Coastal Plains, inland in eastern Texas	NL <sup>1,5</sup>	T <sup>9</sup>	T <sup>8</sup>	BX, CM, HA, MD	transient
Interior Least Tern	<i>Sterna antillarum athalassas</i>	Nesting on large river sandbars	E <sup>1</sup>	E <sup>9</sup>	E <sup>8</sup>	BX, CM, HA, MD	transient
Black-capped Vireo	<i>Vireo atricapillus</i>	Semi-open broad-leaved shrublands. oak-juniper woodlands with distinctive patchy, two-layered shrub-tree aspect	E <sup>1</sup>	E <sup>9</sup>	T <sup>8</sup>	BX, HA	migratory
<b>REPTILES:</b>							
Timber Rattlesnake	<i>Crotalus horridus</i>	Bottomland hardwoods	NL <sup>1,5</sup>	T <sup>9</sup>	NL <sup>8</sup>	BX, HA	endemic
Texas Indigo Snake	<i>Drymarchon corais erebennus</i>	Open arid and semi-arid regions with sparse vegetation including grass, cactus, scattered brush or scrubby trees; soil may vary in texture from sandy to rocky, burrows in soil, enters rodent burrow, or hides under rocks when inactive	NL <sup>1,5</sup>	T <sup>9</sup>	WL <sup>8</sup>	BX, MD	endemic

<sup>1</sup> U.S. Fish and Wildlife Service Division of Endangered Species. U.S. listed vertebrate animal species index by lead region and status as of January 31,1997. U.S. Fish and Wildlife Endangered Species Home Page.

<sup>2</sup> U.S. Fish and Wildlife Service Division of Endangered Species. U.S. listed invertebrate animal species index by lead region and status as of January 31,1997. U.S. Fish and Wildlife Endangered Species Home Page.

<sup>3</sup> U.S. Fish and Wildlife Service Division of Endangered Species. U.S. listed flowering plant species index by lead region and status as of January 31,1997. U.S. Fish and Wildlife Endangered Species Home Page.

<sup>4</sup> U.S. Fish and Wildlife Service Division of Endangered Species. U.S. listed Non-flowering plant species index by lead region and status as of January 31,1997. U.S. Fish and Wildlife Endangered Species Home Page.

<sup>5</sup> Federal Register. February 28, 1996. 50 CFR Part 17. Review of plant and animal taxa that are candidates for listing as endangered or threatened species. Fish and Wildlife Service Division, U.S. Department of the Interior. Notice of Review.

<sup>6</sup> Texas Biological and Conservation Data System. Texas Parks and Wildlife Department, Endangered Resources Branch. County lists of Texas' special species. (Bastrop, Bell, Burlinson, Burnet, Colorado, Fayette, Hays, Lee, Llano, Milam, Travis, Washington and Williamson Counties revised Jan. 13, 1997)

<sup>7</sup> Texas Organization for Endangered Species. August 1993. Endangered, threatened and watch lists of Texas plants. TOES Publication 9, third revision.

<sup>8</sup> Texas Organization for Endangered Species. January 1988. Endangered, threatened and watch lists of vertebrates of Texas. TOES Publication 6.

<sup>9</sup> Texas Biological and Conservation Data System. Texas Parks and Wildlife Department, Endangered Resources Branch. Species with Federal or Texas State Endangered or Threatened Status. Dec. 1996

<sup>10</sup> Texas Organization for Endangered Species. Sept. 1988. Invertebrates of Special Concern TOES Publication 7.

E - Endangered PE - Proposed endangered S/A - threatened due to similarity of appearance to protected species T - Threatened C - Candidate NL - Not Listed WL - Watch List  
V - Category V TOES Plant Watch List

Common Name	Scientific Name	Habitat Preference	USFWS Listing	TPWD Listing	TOES Listing	Counties of Occurrence	Potential Occurrence
Texas Tortoise	<i>Gopherus berlandieri</i>	Open brush with grass understory; open grass and bare ground are avoided; occupies shallow depressions at base of bush or cactus, underground burrows, under objects; active March through November	NL <sup>1,5</sup>	T <sup>9</sup>	T <sup>8</sup>	BX, MD	endemic
Cagle's Map Turtle	<i>Graptemys caglei</i>	Waters of the Guadalupe River Basin	C <sup>5</sup>	NL <sup>6,9</sup>	NL <sup>8</sup>	BX, CM, HA	endemic
Spot-tailed Earless Lizard	<i>Holbrookia lacerata</i>	Rocky desert flats, areas with sparse vegetation or mesquite-prickly pear associations, and the uplands of the Edwards Plateau	NL <sup>1,5</sup>	NL <sup>6,9</sup>	NL <sup>8</sup>	BX, CM, HA	endemic
Keeled Earless Lizard	<i>Holbrookia propinqua</i>	Prefers sandy environments, common on sand dunes and barrier beaches within its range	NL <sup>1,5</sup>	NL <sup>6,9</sup>	NL <sup>8</sup>	BX, HA, MD	endemic
Texas Horned Lizard	<i>Phrynosoma cornutum</i>	Varied, sparsely vegetated uplands, open desert and grasslands	NL <sup>1,5</sup>	T <sup>9</sup>	T <sup>8</sup>	BX, CM, HA, MD	endemic
AMPHIBIANS:							
Cascade Cavern Salamander	<i>Eurycea latitans</i>	Subterranean streams and pools, Cascade Cavern, Kendall County, Texas.	NL <sup>1,5</sup>	T <sup>6</sup>	T <sup>8</sup>	CM	endemic
San Marcos Salamander	<i>Eurycea nana</i>	Spring flows, submerged vegetation	T <sup>1</sup>	T <sup>6</sup>	T <sup>8</sup>	HA	endemic
Texas Salamander	<i>Eurycea neotenes</i>	Springs of the Edwards Aquifer and Balconies Escarpment	NL <sup>1,5</sup>	NL <sup>6,9</sup>	NL <sup>8</sup>	BX	endemic
Blanco River Springs Salamander	<i>Eurycea pterophila</i>	Subterranean aquatic karst and springs	NL <sup>1,5</sup>	NL <sup>6,9</sup>	NL <sup>8</sup>	HA	endemic
Blanco Blind Salamander	<i>Eurycea robusta</i>	Subterranean aquatic karst	NL <sup>1,5</sup>	E <sup>6</sup>	NL <sup>8</sup>	HA	endemic

<sup>1</sup> U.S. Fish and Wildlife Service Division of Endangered Species. U.S. listed vertebrate animal species index by lead region and status as of January 31, 1997. U.S. Fish and Wildlife Endangered Species Home Page.

<sup>2</sup> U.S. Fish and Wildlife Service Division of Endangered Species. U.S. listed invertebrate animal species index by lead region and status as of January 31, 1997. U.S. Fish and Wildlife Endangered Species Home Page.

<sup>3</sup> U.S. Fish and Wildlife Service Division of Endangered Species. U.S. listed flowering plant species index by lead region and status as of January 31, 1997. U.S. Fish and Wildlife Endangered Species Home Page.

<sup>4</sup> U.S. Fish and Wildlife Service Division of Endangered Species. U.S. listed Non-flowering plant species index by lead region and status as of January 31, 1997. U.S. Fish and Wildlife Endangered Species Home Page.

<sup>5</sup> Federal Register. February 28, 1996. 50 CFR Part 17. Review of plant and animal taxa that are candidates for listing as endangered or threatened species. Fish and Wildlife Service Division, U.S. Department of the Interior. Notice of Review.

<sup>6</sup> Texas Biological and Conservation Data System. Texas Parks and Wildlife Department, Endangered Resources Branch. County lists of Texas' special species. (Bastrop, Bell, Borden, Burnet, Colorado, Fayette, Hays, Lee, Llano, Milam, Travis, Washington and Williamson Counties revised Jan. 13, 1997)

<sup>7</sup> Texas Organization for Endangered Species. August 1993. Endangered, threatened and watch lists of Texas plants. TOES Publication 9, third revision.

<sup>8</sup> Texas Organization for Endangered Species. January 1988. Endangered, threatened and watch lists of vertebrates of Texas. TOES Publication 6.

<sup>9</sup> Texas Biological and Conservation Data System. Texas Parks and Wildlife Department, Endangered Resources Branch. Species with Federal or Texas State Endangered or Threatened Status. Dec. 1996

<sup>10</sup> Texas Organization for Endangered Species. Sept. 1988. Invertebrates of Special Concern TOES Publication 7.

Common Name	Scientific Name	Habitat Preference	USFWS Listing	TPWD Listing	TOES Listing	Counties of Occurrence	Potential Occurrence
Edwards Plateau Spring Salamander	<i>Eurycea sp 7</i>	Subterranean aquatic karst and springs	NL <sup>1,5</sup>	NL <sup>6,9</sup>	NL <sup>8</sup>	BX, CM, HA, MD	endemic
Comal Blind Salamander	<i>Eurycea tridentifera</i>	Subterranean waters of limestone caves. Cibilo Creek system (Comal) and Elm Springs Cave (Bexar)	NL <sup>1,5</sup>	T <sup>6</sup>	T <sup>8</sup>	BX, CM	endemic
Valdina Farms Sinkhole Salamander	<i>Eurycea troglodytes</i>	Intermittent pools of subterranean streams	NL <sup>1,5</sup>	NL <sup>6,9</sup>	NL <sup>8</sup>	MD	endemic
Black-spotted Newt	<i>Notophthalmus meridionalis</i>	Quiet stretches of streams with submerged vegetation; permanent and temporary ponds and ditches	NL <sup>1,5</sup>	T <sup>6</sup>	E <sup>8</sup>	BX	endemic
Mexican Treefrog	<i>Smilisca baudinii</i>	Humid places along streams, in canyons, in trees and shrubs	NL <sup>1,5</sup>	T <sup>6</sup>	E <sup>8</sup>	BX	endemic
Texas Blind Salamander	<i>Typhlomolge rathbuni</i>	Subterranean streams of the Purgatory Creek system	E <sup>1</sup>	E <sup>6</sup>	T <sup>8</sup>	HA	endemic
FISH:							
Blue Sucker	<i>Cycleptus elongatus</i>	Larger rivers throughout the Mississippi Basin; In Texas, major streams southward to the Rio Grande	NL <sup>1,5</sup>	T <sup>9</sup>	NL <sup>8</sup>	HA	endemic
Fountain Darter	<i>Etheostoma fonticola</i>	San Marcos River to confluence with Blanco River; associated with San Marcos Salamander in quiet, clear water	E <sup>1</sup>	E <sup>9</sup>	E <sup>8</sup>	CM, HA	endemic
San Marcos Gambusia	<i>Gambusia georgei</i>	San Marcos River to confluence with Blanco River, large clear spring-fed river	E <sup>1</sup>	E <sup>9</sup>	E <sup>8</sup>	HA	endemic
Guadalupe Bass	<i>Micropterus treculi</i>	Clear flowing streams of eastern Edwards Plateau	NL <sup>1,5</sup>	NL <sup>6,9</sup>	WL <sup>8</sup>	BX, CM, HA	endemic
Widemouth Blindcat	<i>Satan eurystomus</i>	Subterranean caverns of the San Antonio Pool of the Edwards Aquifer, Bexar County, Texas	NL <sup>1,5</sup>	T <sup>6</sup>	T <sup>8</sup>	BX	endemic

<sup>1</sup> U.S. Fish and Wildlife Service Division of Endangered Species. U.S. listed vertebrate animal species index by lead region and status as of January 31,1997. U.S. Fish and Wildlife Endangered Species Home Page.

<sup>2</sup> U.S. Fish and Wildlife Service Division of Endangered Species. U.S. listed invertebrate animal species index by lead region and status as of January 31,1997. U.S. Fish and Wildlife Endangered Species Home Page.

<sup>3</sup> U.S. Fish and Wildlife Service Division of Endangered Species. U.S. listed flowering plant species index by lead region and status as of January 31,1997. U.S. Fish and Wildlife Endangered Species Home Page.

<sup>4</sup> U.S. Fish and Wildlife Service Division of Endangered Species. U.S. listed Non-flowering plant species index by lead region and status as of January 31,1997. U.S. Fish and Wildlife Endangered Species Home Page.

<sup>5</sup> Federal Register. February 28, 1996. 50 CFR Part 17. Review of plant and animal taxa that are candidates for listing as endangered or threatened species. Fish and Wildlife Service Division, U.S. Department of the Interior. Notice of Review.

<sup>6</sup> Texas Biological and Conservation Data System. Texas Parks and Wildlife Department, Endangered Resources Branch. County lists of Texas' special species. (Bastrop, Bell, Burleson, Burnet, Colorado, Fayette, Hays, Lee, Llano, Milam, Travis, Washington and Williamson Counties revised Jan. 13, 1997)

<sup>7</sup> Texas Organization for Endangered Species. August 1993. Endangered, threatened and watch lists of Texas plants. TOES Publication 9, third revision.

<sup>8</sup> Texas Organization for Endangered Species. January 1988. Endangered, threatened and watch lists of vertebrates of Texas. TOES Publication 6.

<sup>9</sup> Texas Biological and Conservation Data System. Texas Parks and Wildlife Department, Endangered Resources Branch. Species with Federal or Texas State Endangered or Threatened Status. Dec. 1996

<sup>10</sup> Texas Organization for Endangered Species. Sept. 1988. Invertebrates of Special Concern TOES Publication 7.

E - Endangered PE - Proposed endangered S/A - threatened due to similarity of appearance to protected species T - Threatened C - Candidate NL - Not Listed WL - Watch List  
V - Category V TOES Plant Watch List

Common Name	Scientific Name	Habitat Preference	USFWS Listing	TPWD Listing	TOES Listing	Counties of Occurrence	Potential Occurrence
Toothless Blindcat	<i>Trogloglanis pattersoni</i>	Subterranean caverns of the San Antonio Pool of the Edwards Aquifer, Bexar County, Texas	NL <sup>1,5</sup>	T <sup>6</sup>	T <sup>8</sup>	BX	endemic
<b>INVERTEBRATES:</b>							
Helotes Mold Beetle	<i>Batrissodes venyivi</i>	Caves of Bexar County, Texas	NL <sup>2,5</sup>	NL <sup>6</sup>	SOC <sup>10</sup>	BX	endemic
Flint's Net-Spinning Caddisfly	<i>Cheumatopsyche flinti</i>	Honey Creek, Hays County, Texas	NL <sup>2,5</sup>	NL <sup>6,9</sup>	SOC <sup>10</sup>	HA	endemic
Robber Baron Cave Spider	<i>Cicurina baroni</i>	Caves of Bexar County, Texas	NL <sup>2,5</sup>	NL <sup>6</sup>	SOC <sup>10</sup>	BX	endemic
Madla's Cave Spider	<i>Cicurina madla</i>	Caves of Bexar County, Texas	NL <sup>2,5</sup>	NL <sup>6</sup>	SOC <sup>10</sup>	BX	endemic
Veni's Cave Spider	<i>Cicurina venii</i>	Caves of Bexar County, Texas	NL <sup>2,5</sup>	NL <sup>6</sup>	SOC <sup>10</sup>	BX	endemic
Vesper Cave Spider	<i>Cicurina vespera</i>	Caves of Bexar County, Texas	NL <sup>2,5</sup>	NL <sup>6</sup>	SOC <sup>10</sup>	BX	endemic
Edwards Aquifer Diving Beetle	<i>Haideoporus texanus</i>	Springs of the Edwards Aquifer	NL <sup>2,5</sup>	NL <sup>6,9</sup>	SOC <sup>10</sup>	CM, HA	endemic
Comal Springs Riffle Beetle	<i>Heterelmis comalensis</i>	Headwater springs to the Comal River	PE <sup>5</sup>	PE <sup>6</sup>	NL <sup>6,10</sup>	CM, HA	endemic
Government Canyon Cave Spider	<i>Neoleptoneta microps</i>	Caves of Bexar County, Texas	NL <sup>2,5</sup>	NL <sup>6</sup>	SOC <sup>10</sup>	BX	endemic
Texas Cave Shrimp	<i>Palaemonetes antrorum</i>	Edwards Aquifer and Ezell's Cave, Hays County, Texas	NL <sup>2,5</sup>	NL <sup>6,9</sup>	SOC <sup>10</sup>	HA	endemic
San Marcos Saddle-Case Caddisfly	<i>Protoptila arca</i>	San Marcos River	NL <sup>2,5</sup>	NL <sup>6,9</sup>	SOC <sup>10</sup>	HA	endemic
A Ground Beetle	<i>Rhadine exilis</i>	Caves of Bexar County, Texas	NL <sup>2,5</sup>	NL <sup>6</sup>	SOC <sup>10</sup>	BX, CM	endemic
A Ground Beetle	<i>Rhadine infernalis</i>	Caves of Bexar County, Texas	NL <sup>2,5</sup>	NL <sup>6</sup>	SOC <sup>10</sup>	BX	endemic

<sup>1</sup> U.S. Fish and Wildlife Service Division of Endangered Species. U.S. listed vertebrate animal species index by lead region and status as of January 31, 1997. U.S. Fish and Wildlife Endangered Species Home Page.

<sup>2</sup> U.S. Fish and Wildlife Service Division of Endangered Species. U.S. listed invertebrate animal species index by lead region and status as of January 31, 1997. U.S. Fish and Wildlife Endangered Species Home Page.

<sup>3</sup> U.S. Fish and Wildlife Service Division of Endangered Species. U.S. listed flowering plant species index by lead region and status as of January 31, 1997. U.S. Fish and Wildlife Endangered Species Home Page.

<sup>4</sup> U.S. Fish and Wildlife Service Division of Endangered Species. U.S. listed Non-flowering plant species index by lead region and status as of January 31, 1997. U.S. Fish and Wildlife Endangered Species Home Page.

<sup>5</sup> Federal Register. February 28, 1996. 50 CFR Part 17. Review of plant and animal taxa that are candidates for listing as endangered or threatened species. Fish and Wildlife Service Division, U.S. Department of the Interior. Notice of Review.

<sup>6</sup> Texas Biological and Conservation Data System. Texas Parks and Wildlife Department, Endangered Resources Branch. County lists of Texas' special species. (Bastrop, Bell, Borden, Burnet, Colorado, Fayette, Hays, Lee, Llano, Milam, Travis, Washington and Williamson Counties revised Jan. 13, 1997)

<sup>7</sup> Texas Organization for Endangered Species. August 1993. Endangered, threatened and watch lists of Texas plants. TOES Publication 9, third revision.

<sup>8</sup> Texas Organization for Endangered Species. January 1988. Endangered, threatened and watch lists of vertebrates of Texas. TOES Publication 6.

<sup>9</sup> Texas Biological and Conservation Data System. Texas Parks and Wildlife Department, Endangered Resources Branch. Species with Federal or Texas State Endangered or Threatened Status. Dec. 1996

<sup>10</sup> Texas Organization for Endangered Species. Sept. 1988. Invertebrates of Special Concern TOES Publication 7.

Common Name	Scientific Name	Habitat Preference	USFWS Listing	TPWD Listing	TOES Listing	Counties of Occurrence	Potential Occurrence
Maculated Manfreda Skipper	<i>Stallingsia maculosa</i>		NL <sup>2,5</sup>	NL <sup>6</sup>	SOC <sup>10</sup>	BX	endemic
Ezell's Cave Amphipod	<i>Stygobromus flagellatus</i>	Ezell's Cave, Hays County, Texas	NL <sup>2,5</sup>	NL <sup>6,9</sup>	SOC <sup>10</sup>	HA	endemic
Robber Baron Cave Harvestman	<i>Texella cokendolpheri</i>	Caves of Bexar County, Texas	NL <sup>2,5</sup>	NL <sup>6</sup>	SOC <sup>10</sup>	BX	endemic
<b>MOLLUSKS</b>							
Mimic Cavesnail	<i>Phreatodrobia imitata</i>	Caves of Bexar County, Texas	NL <sup>2,5</sup>	NL <sup>6</sup>	NL <sup>100</sup>	BX	endemic
Horseshoe Liptooth	<i>Polygyra hippocrepis</i>	Waters of Hays County, Texas	NL <sup>2,5</sup>	NL <sup>6,9</sup>	NL <sup>6,10</sup>	HA	endemic
<b>PLANTS:</b>							
Elmendorf's Onion	<i>Allium elmendorffii</i>	Grassland openings in post oak woodlands on deep well drained sands derived from Queen City and similar Eocene formations; habitat at sites on coastal plain and in Llano Uplift	NL <sup>3,5</sup>	NL <sup>6,9</sup>	V <sup>7</sup>	BX	endemic
Hill Country Wild-mercury	<i>Argythamnia aphoroides</i>	Shallow to moderately deep clays and clay loams over limestone, in grasslands associated with plateau live oak woodlands, mostly on rolling uplands	NL <sup>3,5</sup>	NL <sup>6,9</sup>	V <sup>7</sup>	CM, HA	endemic
South Texas Rushpea	<i>Caesalpinia phyllanthoides</i>	South Texas	NL <sup>3,5</sup>	NL <sup>6</sup>	NL <sup>7</sup>	BX	endemic
Glass Mountains Coral-root	<i>Hexalectris nitida</i>	Beneath oaks or in cedar - oak groves on the Edwards Plateau	NL <sup>3,5</sup>	NL <sup>6,9</sup>	NL <sup>6,7</sup>	BX, CM, HA	endemic

<sup>1</sup> U.S. Fish and Wildlife Service Division of Endangered Species. U.S. listed vertebrate animal species index by lead region and status as of January 31, 1997. U.S. Fish and Wildlife Endangered Species Home Page.

<sup>2</sup> U.S. Fish and Wildlife Service Division of Endangered Species. U.S. listed invertebrate animal species index by lead region and status as of January 31, 1997. U.S. Fish and Wildlife Endangered Species Home Page.

<sup>3</sup> U.S. Fish and Wildlife Service Division of Endangered Species. U.S. listed flowering plant species index by lead region and status as of January 31, 1997. U.S. Fish and Wildlife Endangered Species Home Page.

<sup>4</sup> U.S. Fish and Wildlife Service Division of Endangered Species. U.S. listed Non-flowering plant species index by lead region and status as of January 31, 1997. U.S. Fish and Wildlife Endangered Species Home Page.

<sup>5</sup> Federal Register. February 28, 1996. 50 CFR Part 17. Review of plant and animal taxa that are candidates for listing as endangered or threatened species. Fish and Wildlife Service Division, U.S. Department of the Interior. Notice of Review.

<sup>6</sup> Texas Biological and Conservation Data System. Texas Parks and Wildlife Department, Endangered Resources Branch. County lists of Texas' special species. (Bastrop, Bell, Bureson, Burnet, Colorado, Fayette, Hays, Lee, Llano, Milam, Travis, Washington and Williamson Counties revised Jan. 13, 1997)

<sup>7</sup> Texas Organization for Endangered Species. August 1993. Endangered, threatened and watch lists of Texas plants. TOES Publication 9, third revision.

<sup>8</sup> Texas Organization for Endangered Species. January 1988. Endangered, threatened and watch lists of vertebrates of Texas. TOES Publication 6.

<sup>9</sup> Texas Biological and Conservation Data System. Texas Parks and Wildlife Department, Endangered Resources Branch. Species with Federal or Texas State Endangered or Threatened Status. Dec. 1996

<sup>10</sup> Texas Organization for Endangered Species. Sept. 1988. Invertebrates of Special Concern TOES Publication 7.

Common Name	Scientific Name	Habitat Preference	USFWS Listing	TPWD Listing	TOES Listing	Counties of Occurrence	Potential Occurrence
Warnock's Coral-root	<i>Hexalectris warnockii</i>	Among rocks in shaded canyons on the Edwards Plateau	NL <sup>3,5</sup>	NL <sup>6,9</sup>	NL <sup>6,7</sup>	HA	endemic
Sandhill Wooleywhite	<i>Hymenopappus carrizoanus</i>	Calcareous soils of Rio Grande Plains and Edwards Plateau	NL <sup>3,5</sup>	NL <sup>6</sup>	NL <sup>7</sup>	BX, MD	endemic
Canyon Mock-orange	<i>Philadelphus ernestii</i>	Edwards Plateau, solution pitted outcrops of Cretaceous limestone on caprock along mesic canyons, usually in shade of mixed canyon woodlands	NL <sup>3,5</sup>	NL <sup>6,9</sup>	V <sup>7</sup>	CM, HA	endemic
Texas Mock-Orange	<i>Philadelphus texensis</i>	Limestone bluffs and among boulders on Edwards Plateau	NL <sup>3,5</sup>	NL <sup>6</sup>	NL <sup>7</sup>	CM, MD	endemic
Correll's False Dragon-head	<i>Physotegia correllii</i>	Wet silty clay loams on streamsides, in creekbeds, irrigation channels, and roadside drainage ditches	NL <sup>3,5</sup>	NL <sup>6,9</sup>	V <sup>7</sup>	BX	endemic
Parks' Jointweed	<i>Polygonella parksii</i>	Early successful grasslands and openings in post oak woodlands on deep loose whitish sands of Carrizo and other Eocene formations	NL <sup>3,5</sup>	NL <sup>6,9</sup>	V <sup>7</sup>	BX	endemic
Big Red Sage	<i>Salvia penstemonoides</i>	In seepage on limestone ledges and banks along streams in central Edwards Plateau	NL <sup>3,5</sup>	NL <sup>6</sup>	NL <sup>7</sup>	BX	endemic
Bracted Twistflower	<i>Streptanthus bracteatus</i>	Shallow, well drained gravelly clays and clay loams over limestone. in oak-juniper woodlands and associated openings. on steep to moderate slopes and in canyon bottoms of the Edwards Plateau. April through May	NL <sup>3,5</sup>	NL <sup>6,9</sup>	V <sup>7</sup>	BX, CM, MD	endemic
Texas Wild Rice	<i>Zizania texana</i>	Known only from the San Marcos River (Hays County) where it occurs in clear flowing water from springs of constant cool temperature.	E <sup>3</sup>	E <sup>9</sup>	E <sup>7</sup>	HA	endemic

<sup>1</sup> U.S. Fish and Wildlife Service Division of Endangered Species. U.S. listed vertebrate animal species index by lead region and status as of January 31, 1997. U.S. Fish and Wildlife Endangered Species Home Page.

<sup>2</sup> U.S. Fish and Wildlife Service Division of Endangered Species. U.S. listed invertebrate animal species index by lead region and status as of January 31, 1997. U.S. Fish and Wildlife Endangered Species Home Page.

<sup>3</sup> U.S. Fish and Wildlife Service Division of Endangered Species. U.S. listed flowering plant species index by lead region and status as of January 31, 1997. U.S. Fish and Wildlife Endangered Species Home Page.

<sup>4</sup> U.S. Fish and Wildlife Service Division of Endangered Species. U.S. listed Non-flowering plant species index by lead region and status as of January 31, 1997. U.S. Fish and Wildlife Endangered Species Home Page.

<sup>5</sup> Federal Register. February 28, 1996. 50 CFR Part 17. Review of plant and animal taxa that are candidates for listing as endangered or threatened species. Fish and Wildlife Service Division, U.S. Department of the Interior. Notice of Review.

<sup>6</sup> Texas Biological and Conservation Data System. Texas Parks and Wildlife Department, Endangered Resources Branch. County lists of Texas' special species. (Bastrop, Bell, Bureson, Burnet, Colorado, Fayette, Hays, Lee, Llano, Milam, Travis, Washington and Williamson Counties revised Jan. 13, 1997)

<sup>7</sup> Texas Organization for Endangered Species. August 1993. Endangered, threatened and watch lists of Texas plants. TOES Publication 9, third revision.

<sup>8</sup> Texas Organization for Endangered Species. January 1988. Endangered, threatened and watch lists of vertebrates of Texas. TOES Publication 6.

<sup>9</sup> Texas Biological and Conservation Data System. Texas Parks and Wildlife Department, Endangered Resources Branch. Species with Federal or Texas State Endangered or Threatened Status. Dec. 1996

<sup>10</sup> Texas Organization for Endangered Species. Sept. 1988. Invertebrates of Special Concern TOES Publication 7.

E - Endangered PE - Proposed endangered S/A - threatened due to similarity of appearance to protected species T - Threatened C - Candidate NL - Not Listed WL - Watch List  
V - Category V TOES Plant Watch List

(This page intentionally left blank)

pressures on black-capped vireo reproduction due to nest parasitism by cowbirds (*Molothrus ater*) and the presence of fire ants (*Solenopsis invicta*) may be more serious threats to survival than habitat loss.

Other Endangered/Threatened species which favor aquatic and riparian habitats, that occur in the project counties include, the indigo snake (*Drymarchon corais erebennus*), timber rattlesnake (*Crotalus horridus*), blue sucker (*Cycleptus elongatus*), blind Texas salamander (*Typhlomolge rathbuni*), Toothless blindcat (*Trogloglanis pattersoni*), widemouth blindcat (*Satan eurystomus*), Texas salamander (*Eurycea neotenes*), fountain darter (*Etheostoma fonticola*), San Marcos salamander (*Eurycea nana*), San Marcos Gambusia (*Gambusia georgei*), and Texas Wildrice (*Zizania texana*). The Texas subspecies of the indigo snake inhabits dry grassland and thickets near ponds and rivers where it feeds on frogs, small mammals, birds, other snakes, lizards, and young turtles.<sup>32</sup> Medina and Bexar Counties lie within the northern extent of the indigo snake's range. In the western part of its range, the distribution of the timber rattlesnake tends to follow wooded stream valleys that extend out into the plains. However, Bexar County is the only county within the project area where the timber rattlesnake is reported to occur, but the isolated museum records are questionable.<sup>33</sup>

The subterranean aquatic habitats associated with the Edwards Aquifer support a diverse ecosystem. The aquifer also provides habitat for several endangered, threatened, and important subterranean species and is critical for the maintenance of spring habitats containing several other endemic, endangered species (Table 2). Vertebrates and macroinvertebrates have been found at depths ranging from 190 to 2,000 feet in the artesian parts of the aquifer. The Edwards Aquifer is the only underground aquatic habitat in Texas in which vertebrate species live. This type of adaptation is common in constant temperature spring habitats, and can result in endemism where an entire species may be restricted to a particular spring.

The Rio Grande lesser siren inhabits wet or temporarily wet areas such as arroyos, canals, ditches and shallow depressions. During dry spells, the lesser siren aestivates underground to avoid

---

<sup>32</sup> Behler, J. and F.W. King. 1978. The Audubon Society Field Guide to North American Reptiles and Amphibians. Alfred A. Knopf. New York.

<sup>33</sup> Dixon, J.R. 1987. Amphibians and Reptiles of Texas. Texas A&M University Press, College Station, Texas.



Table 2.

## Endangered, Threatened and Important Species Associated with Subterranean Waters of the Edwards Aquifer

Common Name	Scientific Name	Habitat Preference	Listing	Agency	Potential Occurrence in County
			USFWS	TPWD	
Blind Texas Salamander	<i>Typhlomolge rathbuni</i>	Edwards Aquifer springs and caves, thermally stable; troglobitic	E <sup>1</sup>	E <sup>5</sup>	resident
Blind Blanco Salamander	<i>Typhlomolge robusta</i>	Blanco River; subterranean; gravel bed of Dry Blanco only occurrence; troglobitic	NL <sup>1,3</sup>	E <sup>5</sup>	resident
Comal Blind Salamander	<i>Eurycea tridentifera</i>	Honey Creek and limestone caves	NL <sup>1,3</sup>	T <sup>5</sup>	resident
Cascade Caverns Salamander	<i>Eurycea latitans</i>	Cascade Caverns	NL <sup>1,3</sup>	T <sup>5</sup>	resident
Widemouth Blindcat	<i>Satan eurystomus</i>	Edwards Aquifer; subterranean; from artesian wells in Bexar Co., TX; troglobitic <sup>6</sup>	NL <sup>1,3</sup>	T <sup>5</sup>	not confirmed in Hays or Comal
Toothless Blindcat	<i>Trogloglanis pattersoni</i>	Edwards Aquifer; subterranean; from artesian wells in Bexar Co., TX; troglobitic <sup>6</sup>	NL <sup>1,3</sup>	T <sup>5</sup>	not confirmed in Hays or Comal
Texas Cave Diving Beetle	<i>Haideoporus texanus</i>	Edwards Aquifer subterranean caverns <sup>7</sup>	NL <sup>2,3</sup>	NL <sup>4,5</sup>	resident
Balcones Cave Amphipod	<i>Strygobromus balconis</i>	Limestone caves <sup>8</sup>	NL <sup>2,3</sup>	NL <sup>4,5</sup>	resident
Bifurcated Cave Amphipod	<i>Strygobromus bifurcatus</i>	Spring openings <sup>8</sup>	NL <sup>2,3</sup>	NL <sup>4,5</sup>	resident
Ezell's Cave Amphipod	<i>Strygobromus flagellatus</i>	Ezell's Cave; Edwards Aquifer subterranean caverns <sup>7</sup>	NL <sup>2,3</sup>	NL <sup>4,5</sup>	resident
Peck's Cave Amphipod	<i>Strygobromus pecki</i>	Comal Springs	PE <sup>3</sup>	PE <sup>4,5</sup>	resident
Texas Cave Shrimp	<i>Palaemonetes antrorum</i>	Ezell's Cave and Edwards Aquifer subterranean caverns <sup>7</sup>	NL <sup>2,3</sup>	NL <sup>4,5</sup>	resident
Mimic Cave Snail	<i>Phreatodrobia imitata</i>	Edwards Aquifer subterranean caverns; from artesian wells in Bexar Co., TX; troglobitic <sup>9</sup>	NL <sup>2,3</sup>	NL <sup>4</sup>	not confirmed

E - Endangered PE - Proposed endangered T - Threatened NL - Not Listed

<sup>1</sup> U.S. Fish and Wildlife Service Division of Endangered Species. U.S. listed vertebrate animal species index by lead region and status as of January 31, 1997. U.S. Fish and Wildlife Endangered Species Home Page.

<sup>2</sup> U.S. Fish and Wildlife Service Division of Endangered Species. U.S. listed invertebrate animal species index by lead region and status as of January 31, 1997. U.S. Fish and Wildlife Endangered Species Home Page.

<sup>3</sup> Federal Register. Sept. 19, 1997. 50 CFR Part 17. Review of plant and animal taxa that are candidates or proposed for listing as endangered or threatened species. Fish and Wildlife Service Division, U.S. Department of the Interior. Proposed Rule.

<sup>4</sup> Texas Biological and Conservation Data System. Texas Parks and Wildlife Department, Endangered Resources Branch. County lists of Texas' special species. (Bandera, Bastrop, Bell, Bexar, Blanco, Burleson, Burnet, Colorado, Comal, Fayette, Hays, Kerr, Lee, Llano, Medina, Milam, Travis, Washington and Williamson Counties revised Jan. 13, 1997)

<sup>5</sup> Texas Biological and Conservation Data System. Texas Parks and Wildlife Department, Endangered Resources Branch. Species with Federal or Texas State Endangered or Threatened Status. Dec. 1996.

<sup>6</sup> Longley, G. and H. Karnei, Jr. 1979. Status of *Trogloglanis pattersoni* Eigenmann, the Toothless Blindcat, and status of *Satan eurystomus* Hubbs and Bailey, the Widemouth Blindcat. US Fish and Wildlife Service, Albuquerque, New Mexico, Endangered Species Report 5, 48 p.

<sup>7</sup> W.R. Elliot, personal communication January 1993.

<sup>8</sup> J.R. Reddell, personal communication January 1993.

<sup>9</sup> Herschler, R. and G. Longley. 1986. *Hadoceras taylori*, a new genus and species of phreatic Hydrobiidae (Gastropoda: Rissoacea) from south-central Texas. Proceedings of the Biological Society of Washington, 99(1):121-136.

desiccation. Lesser sirens have been reported in the neighboring counties to the south but not in the project area counties.<sup>34</sup>

The Texas salamander inhabits springs associated with the Balcones Escarpment and Edwards Aquifer. The isolation of populations of the Texas salamander in springs favors evolutionary divergence in which, in the most extreme cases, entire species can be unique particular springs. The fountain darter (*Etheostoma fonticola*), San Marcos salamander, San Marcos Gambusia, and Texas Wildrice are found only in association with the San Marcos River.

Several Springs in Medina, Bexar, Comal, and Hays Counties support populations of the Texas Salamander, a rare species that is restricted to springs. The isolation of populations in springs favors evolutionary divergence wherein a species or subspecies may be restricted to a small number of springs or in the most extreme case restriction to a particular spring.

The large, perennial, spring-fed streams above the recharge zone support unique (for Texas) clear water communities lined with bald cypress and typically exhibiting diverse and abundant assemblages of aquatic vegetation. The invertebrate and fish fauna, likewise tends to be somewhat distinct from surrounding areas. For example, the State Fish is the Guadalupe bass (*Micropterus treculi*), which lives only in the streams of the Edwards Plateau region. Historically, the distribution of the Guadalupe bass was restricted to parts of the San Antonio - Guadalupe, Colorado, and Brazos River basins, however, it was introduced by Texas Parks and Wildlife Department into the headwaters of the Nueces River in 1973.<sup>35</sup>

## 2.6 Land Use and Economy

Within the four-county project area, land is used primarily for agricultural purposes (Table 3). Although 74 percent of the land is used for farming or ranching, this is less than average agricultural land use for the State of Texas (81 percent). The lower agricultural land usage reflects the substantial urban development in Hays and especially Bexar County, where 89 percent of the work force in the area resides. The City of San Antonio, located in Bexar County, has a population of 958,273 is the third largest city in Texas and the tenth largest in the United States.

---

<sup>34</sup> Dixon, J.R. 1987. Amphibians and Reptiles of Texas. Texas A&M University Press. College Station, Texas.

<sup>35</sup> Page, L.M. and B.M. Burr. 1991. A Field Guide to Freshwater Fishes, North America North of Mexico. Houghton Mifflin Company, Boston.

Table 3.  
Land Use and Employment in Bexar, Comal, Hays, and Medina Counties  
Compared to the State.<sup>36</sup>

	State	Bexar	Comal	Hays	Medina
Land Area, Acreage	167,693,000	799,000	355,000	434,000	852,000
Land in Farms/Ranches, Acreage	136,300,000	491,000	281,000	325,000	709,000
<u>1987 Employment Profile</u>					
Civilian Labor Force	8,264,300	555,193	25,389	30,842	11,492
Total Employment	7,566,700	510,189	23,918	28,912	10,819
Agricultural	76,565	2,598	70	99	227
Mining	181,400	2,282		8	61
Construction	346,000	27,751	978	1,018	212
Manufacturing	928,300	39,615	3,356	1,738	582
Transportation/Public Utility	468,900	16,646	494	619	160
Trade	1,642,400	121,112	3,779	4,042	1,593
Financial/Insurance/Real Estate	442,800	36,451	765	616	176
Services/Other	1,429,800	105,135	3,675	3,323	1,115
State Government	232,000	9,735	131	3,391	108
Local Government	716,700	52,519	1,989	2,192	1,249
Total Annual Wage (\$ millions)	123,285	7,232	210	234	72
Average Weekly Wage (\$)	304	340	277	273	247
Federal Employment	195,716	43,722	96	115	60
Total Annual Federal Wage (\$ thous)	4,891,525	873,049	2,578	2,815	1,415

<sup>36</sup> Clements, J. 1988. Texas Facts: A Comprehensive Look at Texas Today County by County. Clements Research II, Inc. Dallas, Texas.

San Antonio is Texas' largest military center and has a diverse manufacturing base with an emphasis on high-tech industries.

Medina County ranked 64th in 1985 in state agricultural receipts, of which 58 percent were in livestock and livestock products. In 1985, about 83 percent of the total 852 thousand acres of land was in farms or ranches. About 16 percent of the agricultural land was in harvested cropland and 6 percent was irrigated. The primary livestock and products are beef and dairy cattle, sheep, wool, angora goats, and mohair. The primary crops are feed sorghum and corn, and wheat. Fruits and vegetables, including peaches, pecans, carrots, potatoes, and cabbages are locally important. Tourism travel expenditures in 1986 generated about 122 jobs and \$1.7 million in payroll.

Bexar County ranked 38th in 1985 in state agricultural receipts, of which 52 percent was derived from crops. About 19 percent of the cropland is harvested cropland and 3 percent is irrigated. Primary crops include sorghum and corn for feed, and hay. Primary vegetables, fruits and nuts include carrots, potatoes, sweet corn, cabbage, peaches, and pecans. Primary livestock and livestock products include beef and dairy cattle, sheep, and wool.

In 1987, the county ranked 4th in the state in the volume of retail sales. The businesses and industries with the most employment are restaurants, special trade contractors, wholesale trade-nondurable goods, hospitals, insurance carriers, food stores, transportation, and public utilities. Nonfarm personal income in 1986 exceeded 14.5 billion dollars. Comal County ranked 229th in 1985 in agricultural receipts, of which 76 percent was derived from livestock and livestock products including beef cattle, sheep, wool, angora goats, and mohair. About 6 percent of the agricultural land is used as harvested cropland and less than 1 percent is irrigated. Primary crops include hay, sorghum for feed, and wheat. Primary vegetables and fruits include potatoes, sweet potatoes, peaches, and pecans.

In 1987 the county ranked 44th in the state in the volume of retail sales. The business and industries with the most employment are restaurants, manufacture of textile mill products, contract construction, health services and retail food stores. Nonfarm income in 1986 totaled about \$7.4 million.

Hays County ranked 196th in 1985 in agricultural receipts, of which 77 percent was derived from

livestock and livestock products including beef cattle, sheep, wool, angora goats and mohair. About 8 percent of the agricultural land is used for harvested crops and less than 1 percent is irrigated. Primary crops include hay, and sorghum and corn for feed. Primary vegetables fruits and nuts include tomatoes, and potatoes.

In 1987, the county ranked 37th in the state in the volume of retail sales. The businesses and industries employing the most people included restaurants, manufacturing, contract construction, health services, and finance. Nonfarm income in 1986 totaled \$6.7 million.

The Texas Hill Country Trail spans an area of scenic hills and deeply-sculptured valleys in the rangelands of Medina, Bexar, Comal, and Hays Counties. In Medina County, Hill Country Natural Area covers 4,753 acres and features hiking, bird-watching, horseback riding, and overnight primitive camping. In Bexar County, the San Antonio Missions National Historic Park covers 477 acres and consists of four missions that were part of a network of missions spanning the Spanish Southwest between the 17th and 19th centuries. The Texas Independence Trail surveys sites of historical interest in southeastern Texas and modern visitor attractions such as Johnson Space Center. Numerous other sites in Bexar County are included in the National Register of Historic Places. Tourism in Bexar County in 1986 generated 21,850 jobs and \$264 million. New Braunfels in Comal County is the site of a number of buildings on the National Register of Historic Places and is a popular tourist destination. Also in Comal County is Guadalupe River State Park which covers 1,938 acres and has facilities for camping, trailer hook-ups, fishing, swimming, and hiking on nature trails. In Hays County the City of San Marcos is the home of numerous historic buildings on the National Register of Historic Places and is a popular tourist destination. Travel expenditures in 1986 totaled \$60.8 million, generated 1,000 jobs and \$11.9 million in payroll, a relatively greater proportion of personal income from tourism than that in Bexar County.

## 2.7 Cultural Resources

As part of this study a records search was conducted at the Texas Archeological Research Laboratory in Austin to determine the locations of known cultural resource properties within each project area. This work identified that two of the reservoir sites (Government Canyon and Salado) had received limited cultural resource identification studies in the past. Although dated and incomplete, these previous studies offer some useful information regarding site location and

significance potential. However, since these studies were done in the 1970's, it is likely that the regulatory agencies will require that the cultural properties located within the project area be revisited and reassessed to determine if any damage to the properties has occurred that would, in effect, decrease their significance value. Furthermore, given the lack of cultural information on the remaining reservoir sites, it is likely that the regulatory agencies will also require that each be surveyed to identify and determine the significance potential of any cultural resource properties that may be located thereon.

### 3.0 RECHARGE SITE SUMMARY AND ENVIRONMENTAL IMPACTS EVALUATION MATRIX

#### 3.1 Recharge Site Characteristics.

A total of nine recharge sites are summarized in this study. Although there are only five identified projects, the Northern Bexar and Medina Counties project is made up of five smaller proposed recharge sites. The characteristics of each individual proposed recharge site are summarized in Table 4 of this section and discussed in more detail in the appropriate site section in the main body of the report. All nine of the sites are relatively small, with maximum surface areas ranging from 28 acres at Limekiln Creek to 1,075 acres at the Lower Blanco River site.

With respect to land cover and habitat, the sites of the Upper Blanco, Lower Blanco, Cibolo Creek, and San Geronimo Creek projects are similar in that all four sites are predominantly covered with wood, park, and brush creating a mixture of live oak - Ashe juniper woods and parks.<sup>37,38,39</sup> Grassland represents a minor component to the land cover of these sites. The five sites associated with the Northern Bexar and Medina Counties project are similar to each other with respect to the land cover and habitat in that these sites are predominantly covered with shrubs and brush, with park represented at only the Government Canyon and Salado Creek sites. No woods appear to be represented at these sites based on the Bexar and Medina Counties Soils Surveys, although these areas may have developed park or wood habitat in the years since the aerial photographs used for the soil surveys were taken.

---

<sup>37</sup> Taylor, F.B., R.B. Hailey, and D.L. Richmond. 1962. Soil Survey of Bexar County, Texas. United States Department of Agriculture, Soil Conservation Service, in Cooperation with the Texas Agricultural Experiment Station. Reissued June 1991.

<sup>38</sup> Batte, C.D. 1984. Soil Survey of Comal and Hays Counties, Texas. United States Department of Agriculture, Soil Conservation Service, in Cooperation with the Texas Agricultural Experiment Station.

<sup>39</sup> Dittmar, G.W., M.L. Deike, and D.L. Richmond. 1977. United States Department of Agriculture, Soil Conservation Service, in Cooperation with the Texas Agricultural Experiment Station.

Table 4.  
Recharge Site Summary

	Upper Blanco	Lower Blanco	Cibolo Creek	San Geronimo
Bexar County			X	X
Comal County			X	
Hays County	X	X		
Medina County				X
Recharge Type	1	2	2	2
Normal Pool Elevation (ft msl)	766	740	872	1,083
Area (Acres)	935	1,075	478	183
Volume (ac - ft)	30,000	35,065	10,000	3,500
Vegetational Type (TPWD, 1984)				
Live Oak-Ashe Juniper Parks	X	X	X	
L. Oak-Mesquite-A. Jun. Parks				
Live Oak-Ashe Juniper Woods	X	X	X	X
Land Cover (Acres)				
Wood	331.9	351.5	221.8	14.5
Park	283.3	344.0	95.6	83.8
Brush	139.3	162.3	71.7	53.3
Grass	40.2	73.1	44.5	
Wetlands, Acres (USFWS, 1990)				
Riverine/Lower Perennial/US/SF	18.9			
Riverine/Lower Perennial/OW/DI	32.4	145.1		
Riverine/Intermittent/SB/TF	29.7		44.5	31.5
Riverine/Intermittent/SB/SF				
Riverine/Intermittent/UB				
Palustrine/UB				
Palustrine/US/SF/DI				
Palustrine/FO/BLD/TF	59.6			
Intermittent With No NWI Designation				
Total Wetland Area (Acres)	140.3	145.1	44.5	31.5
Important Species / Habitat *	2	2	2	3
Endangered Species (USFWS) *	1	1	3	3
Aesthetic Attraction, Human Use and Recreation **	3	3	1	1
Cultural Resources *	2	2	2	2
Potential Impacts to Guadalupe Estuary	Minimal	Minimal	Minimal	Minimal

Table 4. (continued)  
Recharge Site Summary

	Deep Creek	Limekiln Creek	Government Canyon	Culebra Creek	Salado Creek
Bexar County			X	X	X
Medina County	X	X			
Recharge Type	2	2	2	2	2
Normal Pool Elevation (ft msl)	1,065	1,094	1,075.5	1,093.1	1,018.3
Area (Acres)	65	28	216	49	247
Volume (ac - ft)	1,983	490	4,977	767	4,192
Vegetational Type (TPWD, 1984)					
Live Oak-Ashe Juniper Parks	X	X	X	X	X
L.Oak-Mesquite-A.Jun. Parks					
Live Oak-Ashe Juniper Woods					
Land Cover (Acres) (based on Soil Survey)					
Shrubs	39.8	13.3	86.4	21.0	61.3
Brush	22.0	14.7	91.2	28.0	141.0
Park			28.8		28.2
Grass			9.5		9.4
Wetlands, Acres (USFWS, 1990)					
Riverine/Lower Perennial/US/SF					
Riverine/Lower Perennial/OW/DI					
Riverine/Intermittent/SB/TF	3.1				7.2
Riverine/Intermittent/SB/SF					
Riverine/Intermittent/UB					
Palustrine/UB					
Palustrine/US/SF/DI					
Intermittent With No NWI Designation		<1	<1	<1	
Total Wetland Area (Acres)	3.1	<1	<1	<1	7.2
Important Species / Habitat *	2	3	1	2	2
Endangered/Threatened Species (USFWS) *	2	3	1	2	2
Aesthetic Attraction, Human Use and Recreation **	1	1	1	1	1
Cultural Resources *	2	2	1,2	2	1,2
Potential Impacts to Guadalupe Estuary	Minimal	Minimal	Minimal	Minimal	Minimal



Table 4. (concluded)  
Recharge Site Summary

**Wetlands:**

US = Unconsolidated Shore

UB = Unconsolidated Bottom

SB = Streambed

OW = Open Water

DI = Diked or Impounded

TF = Temporarily Flooded

SF = Seasonally Flooded

FO = Forested

BLD = Broad Leaved Deciduous

**\* Key to the Endangered / Threatened Species, Important Species / Habitat, and Cultural Resources Code:**

1 = Within Recharge Site

2 = Within One to Two Miles of Recharge Site

3 = Within Vicinity, But Not Necessarily Within the Drainage of the Recharge Site

**\*\* Key to the Human Use and Recreation:**

4 = Very High Use and Aesthetic Attraction, Established Recreational Facility Within the Vicinity

3 = High Use and Aesthetic Attraction, Recreational Use Activities Like Boating and Fishing

2 = Medium Seasonal Recreational Use and Aesthetic attraction

1 = Low to No Public Access

With the exception of the proposed recharge sites on the Blanco River, which is a perennial stream habitat, the proposed recharge sites would impound intermittent streams over the recharge zone. The proposed Upper Blanco River project is a Type 1 (catch and release) recharge, while all other proposed projects are Type 2 direct recharge. Wetland acreages within each site are given as they appear on the National Wetland Inventory maps. Actual wetland types are restricted to perennial and intermittent stream channels. The Upper and Lower Blanco sites are lower perennial while San Geronimo Creek, Cibolo Creek, Deep Creek and Salado Creek are intermittent riverine wetland habitat. Although not described by the NWI maps, Limekiln Creek, Government Canyon, and Culebra Creek appear to be intermittent first or second order headwater drainages based on the NWI maps and USGS topographic maps. The wetland acreages in this table probably represent maxima, although on-site delineations have not been performed, site surveys have found little or no jurisdictional wetlands at the intermittent sites. Of the nine sites considered in this project, the Blanco River is considered the only permanently floatable stream in the entire group by the Texas Outdoor Recreation Plan.<sup>40</sup>

With respect to state and federally listed Endangered and Threatened species, occurrences have been reported from within two miles of all the recharge sites except San Geronimo Creek and Limekiln Creek. Table 1 presented the Endangered and Threatened species by county, while Table 5 presents only the species with occurrences associated with the individual recharge sites. In addition to the sighted habitats and Endangered or Threatened species, there also remains the possibility of unreported karst features and associated species (see Table 2) located within the individual project sites that have not yet been identified. Only the Cibolo Creek and Government Canyon sites have been surveyed for potential karst environments.

Recreational importance is based on available access and reported level of use. The categories used for Human Use and Recreation in Table 4 (low, medium, high, and very high) are relative only to the other sites discussed in this report. Only the Blanco River sites were given high ratings due to the high recreational use, aesthetic attraction, and recreational activities such as fishing and swimming. Although the Government Canyon site is located within Government Canyon State Park, there is presently very little public access to the area at this time. All other sites are

---

<sup>40</sup> TORP 1985. Texas Outdoor Recreation Plan. Texas Parks and Wildlife Department. Comprehensive Planning Branch, Parks Division. Austin, Texas.

Table 5.

Endangered, Threatened and Important Species and Habitats Reported to be in the Area of the Proposed Recharge Sites by the Texas Parks and Wildlife Department, Resource Protection Division's Data Mapping Files.

<b>Important Species</b>					
Common Name	Species Name	USFWS Listing	TPWD Listing	TOES Listing	Recharge*
Golden-cheeked Warbler	<i>Dendroica chrysoparia</i>	E	E	T	Gov. Can. 1,2 Culebra 2,3
Guadalupe Bass	<i>Micropterus treculii</i>	NL	NL	WL	U. Blanco 1 L. Blanco 1
Texas Salamander	<i>Eurycea neotenes</i>	NL	NL	NL	Gov. Can. 2 Culebra 3 Cibolo 2
Comal Blind Salamander	<i>Eurycea tridentifera</i>	NL	T	T	Salado 3
Texas Garter Snake	<i>Thamnophis sirtalis annectens</i>	NL	NL	NL	Culebra 2
Bracted Twistflower	<i>Streptanthos bractatus</i>	NL	NL	V	Deep Crk. 3
Texas Amorpha	<i>Amorpha roemeriana</i>	NL	NL	NL	Gov. Can. 2 Culebra 3
<b>Important Habitats</b>					
Bracken Bat Cave				Private	Cibolo 2
Natural Bridge Caverns				Private	Cibolo 2

Table 5 (Concluded)

Government Canyon State Park		TPWD	Gov. Can. 1,2 Culebra 2,3
Government Canyon Bat Cave		TPWD	Gov. Can. 2 Culebra 3
Texas Oak Series	<i>Quercus buckleyi</i>		Gov. Can. 1,2
Ashe Juniper - Oak Series	<i>Juniperus ashei</i> - <i>Quercus sp.</i>		Gov. Can. 1,2 Culebra 2,3

Key to notes and codes used in Table

\* Proximity to the recharge:

1 = within recharge

2 = within one - two miles

3 = in vicinity of recharge, not necessarily the drainage area

USFWS Listing:

E = Endangered

NL = Not Listed

TPWD Listing:

T = Threatened

E = Endangered

NL = Not Listed

TOES Listing:

T = Threatened

WL = Watch List

NL = Not Listed

V = Category V TOES Plant List

located on private property where little to no access is available to the public for any type of recreation.

### 3.2 Potential Environmental Effects and Mitigation Requirements

All things being equal, the environmental effects of a particular project should be proportional to the size of the area affected. Although this will be roughly true for the nine sites addressed here, they are not all equivalent in terms of environmental importance or sensitivity. Nor are the projects equal in the nature and distribution of their effects on the landscape, biological communities, and human activities and cultural resources. To predict the level of effort that will be required to address and mitigate the environmental consequences of each of the nine proposed recharge sites, the environmental significance and sensitivity of each site, and the effects of each particular structure and its operation, must be evaluated to obtain a probable impacts scenario. This scenario is then used to generate a set of necessary permit related activities and probable mitigative requirements that can be given approximate costs.

As an ecological generalization, it has long been recognized that species diversity is directly related to the physical complexity of the environment, particularly where variations in complexity result from vegetational composition and structure, and are therefore directly related to the availability of food and cover. In central and south Texas, wooded and brushy areas typically exhibit the highest species diversity and are inhabited by species that also occur (perhaps even more abundantly) in grasslands, but the converse is rarely true. With respect to the nine proposed recharge sites, we can begin assessing environmental value in terms of the proportion of woodland and brush versus open lands (pasture/field). Woodland development can also be used as an index of environmental sensitivity, as it takes longer to regenerate the habitats and biotic resources of a mature woodland, relative to a grassland or brush cover in a given region. In the study area, moreover, the live oak-Ashe juniper woodlands are known to be important to several endangered and rare species, allowing some additional discrimination with respect to sensitivity.

Considering freshwater aquatic habitats, the qualities of permanence and consistency are excellent indicators of both biological importance and sensitivity. Species diversity and productivity are both nearly always greater in perennially flowing streams and springs than in intermittent systems, even when permanent pools persist in the latter. Because perennial flow often occurs in isolated situations in the western half of Texas, unique (endemic) species may be present. For those

reasons, and because perennial flow appears to be a diminishing resource here, the sensitivity of lotic habitats, including springs, may be considered high. Conversely, intermittent stream habitats can be considered less important and less sensitive, and stream reaches that dry completely (no remnant pools large enough maintain significant aquatic populations through a dry season) least of all. The foregoing is also relevant to the downstream effects of a recharge, and the necessity of maintaining flows in those reaches.

The two types of recharge projects being considered will differ in their environmental consequences. The conventional, Type 1 recharge (proposed for the Upper Blanco site only) will eliminate terrestrial habitat through dam construction and permanent inundation to the extent of their conservation pools. The terrestrial habitat impacts of the Type 2 recharge will depend primarily on the amount of clearing required and the rapidity of recharge following capture of runoff. Because the Type 1 site is located in a perennial reach of the Blanco River, it will tend to affect more significant aquatic habitats and communities, endangered species or resources, and have more downstream impact than the Type 2 recharge, most of which are proposed for locations on intermittent, temporarily flooded drainages.

Substantial effects on the subterranean fauna of the Edwards Aquifer recharge zone as a result of any, or all, of these projects appears unlikely in the absence of profound water quality changes. The characteristically constant temperature, chemical composition and clarity of the water in the recharge zone, and exiting the springs, is a function of storage in the cavernous limestones of the aquifer, and not of constant quality water entering the recharge zone. Although base flows in the stream reaches above the recharge zone tend to be dominated by springflows from the catchment zone of the Edwards, higher flow regimes are dominated by surface runoff, and are quite variable in physical and chemical quality.

The types and amounts of dissolved and suspended materials entering the recharge zone will not be altered by the Type 2 recharge, as only brief impoundment and immediate recharge will take place. The longer periods of impoundment in the Type 1 recharge have the potential to alter water quality as a result of settling out suspended materials that would have been transported downstream to the recharge zone, and as a result of stratification and dissolved oxygen (DO) depletion in bottom waters of the reservoir. While sediment removal may be desirable, discharge of DO depleted water would be adverse to both downstream aquatic communities and to the aquifer fauna if reaeration was not accomplished before recharge. This can be prevented from

affecting recharge in a number of ways: by rapid release, or release from selected depths during periods of stratification, and by enhancement of reaeration in the reach between the dam and the recharge zone.

The evaluation criteria discussed above are summarized in Table 6, the Environmental Impact Evaluation Matrix. The five proposed projects are arranged in descending order of predicted environmental impact in this table. Although the exact order may be a matter of conjecture, the proposed recharge projects do fall into three rather distinct groups: 1) Highest probable impact, Upper Blanco because of size, extensive woodlands, permanent inundation, affects a perennial reach and will probably require scheduled releases, and possible presence of protected species or resources; 2) Medium probable impact, Lower Blanco, Cibolo Creek, and Government Canyon; 3) Lowest probable impact, the remaining five projects.

Some previous studies have been conducted regarding the impacts to cultural resources caused by surface water recharge.<sup>41</sup> Specific impact zones within the typical recharge include those that occur in the conservation pool, the fluctuation zone, and the backshore zone. Since only one of these recharges is designed to have a conservation pool (the Upper Blanco site), it is perceived that the remainder of these recharges will only receive impacts within the fluctuation zone. Impacts caused in the backshore zone will be minimal, provided that none of these recharges will be used for recreational purposes.

Impacts within the conservation pool are generally mechanical and occur during dam construction, site preparation, and initial filling. If cultural resources survive these initial impacts they may be preserved indefinitely under a stable silt or water column. Within the fluctuation zone, intense flooding and drawdown may cause mechanical erosion of unconsolidated deposits along the natural banks of the channel. In addition, other studies have shown that the episodic wetting and drying that occurs within the fluctuation zone tends to accelerate biochemical processes which could act to destroy chemical residues, and perishable materials that are often preserved by the regionally dry climate. Because of the perceived impacts addressed above, it is anticipated that the regulatory agencies will require that all significant cultural properties identified within the impact area will be mitigated through data recovery.

---

<sup>41</sup> Ware, J.A. 1989. Archeological Inundation Studies: Manual for Reservoir Managers. Environmental Impact Research Program, Contract Report EL-89-4. Final Report. Museum of New Mexico, Santa Fe, New Mexico. September 1989.

**Table 6.**  
**Environmental Impact Evaluation Matrix.**

	Upper Blanco	Lower Blanco	Cibolo Creek	Government Canyon
Woods (acres)	331.9	351.5	221.8	-
Park (acres)	283.3	344	95.6	28.8
Brush (acres)	139.3	162.3	71.7	91.2
Shrubs (acres)	-	-	-	86.4
Wood Type	O/J, PK	O/J, PK	O/J, PK	PK
Stream Flow (S,P,I,R)	P	P,R	I,R	I,R
Special Resources <sup>1</sup>	Yes	Yes	Yes	Yes
Cultural Resources	Yes	Yes	Yes	Yes
Permanent Inundation	Yes	Yes	No	No
Instream Flow Requirement	Possible	Possible	No	No

O/J = Live Oak - Ashe Juniper Woods

PK = Live Oak - Ashe Juniper Parks

Stream Flow Code:

P = Perennial

S = Spring Flow

I = Intermittent

R = Recharge Zone

<sup>1</sup>Special Resources are endangered species, important species or important habitats, detailed in Tables 3 and 4.



Table 6. (Concluded)

	San Geronimo Creek	Salado Creek	Deep Creek	Culebra Creek	Limekiln Creek
Woods (acres)	14.5	-	-	-	-
Park (acres)	83.8	28.2	-	-	-
Brush (acres)	53.3	141.0	22.0	28.0	14.7
Shrubs (acres)	-	61.3	39.8	21.0	13.3
Wood Type	O/J	PK	PK	PK	PK
Stream Flow (S,P,I,R)	I,R	I,R	I,R	I,R	I,R
Special Resources <sup>1</sup>	Yes	Yes	Yes	Yes	Yes
Cultural Resources	Yes	Yes	Yes	Yes	Yes
Permanent Inundation	No	No	No	No	No
Instream Flow Requirement	No	No	No	No	No

O/J = Live Oak - Ashe Juniper Woods

PK = Live Oak - Ashe Juniper Parks

Stream Flow Code:

P = Perennial

S = Spring Flow

I = Intermittent

R = Recharge Zone

<sup>1</sup>Special Resources are endangered species, important species or important habitats, detailed in Tables 3 and 4.

Table 7 summarizes estimated costs for environmental and archeological work, and probable mitigation requirements, for each site. These estimates are based on the project sizes presented in Table 4 to allow planners and environmental professionals information on the potential impacts and mitigation liabilities of each site. Impacts and mitigation requirements for reduced or enlarged capacity designs can often be scaled roughly in proportion to the recharge pool area. Environmental report costs are assumed to include baseline studies, a comprehensive Environmental Assessment, and permit support. With respect to the Type 2 sites, it is conceivable that, although a dam could be constructed in a non-wetland location to avoid obtaining a 404 permit from the USCE, a water rights permit from TNRCC would be required. Notations indicate where the probable need for additional efforts (endangered species, instream flows) have significantly affected projected environmental report costs. Mitigation land costs are given for the Blanco River sites, where long-term impoundment may eliminate terrestrial habitat. These costs should be based on the acquisition of an acreage equal to that of the proposed recharge pool at a cost of \$5,000 per acre. More refined estimates of mitigation land costs are not practical or justified at this stage, as mitigation acreage is typically negotiated with the resource agencies, and will be sensitive to recharge site characteristics and the availability of suitable mitigation sites. Costs for habitat evaluation and site selection studies are expected to be in the range of \$2,500 - \$5,000 per site, depending on the area and vegetation types involved. Management costs are based on \$10/acre/year and in addition to any preparatory work (eg. fence construction) required before acceptance by a management agency. If several sites are to be constructed as part of a single project, a comprehensive Environmental Assessment should be performed. An Environmental Impact Statement - level study that addresses all related project actions would likely be required by TNRCC and USCE. The cost for a comprehensive Environmental Assessment would be roughly equal to the sum of costs for the individual sites.

Given the lack of information, it is difficult to determine an accurate cost for the entire cultural resources component of this project. Generally, the cost for conducting a survey can be estimated based on what is known about site occurrence potential for any given area. However, since the total number and significance potential of cultural resource properties that occur within a particular area is currently unknown, any effort to estimate costs beyond the survey level is based primarily on the results of similar studies conducted within the same region. Previous studies within the region have shown that out of every three sites recorded, one site will require testing. Furthermore if a site is elevated to the testing level there is a 50% chance that it will be determined eligible and require mitigation.

Table 7.  
Projected Costs

	Upper Blanco	Lower Blanco	Cibolo Creek	Government Canyon
100 % Normal Pool Elevation/ Surface Area (MSL / acres)	766 / 935	740 / 1,075	872 / 478	1,075.5 / 216
Recharge Type	1	2	2	2
Environmental Reports (\$)	+100,000	+100,000	50,000	25,000
Threatened/Endangered Species Survey	Yes	Yes	Yes	Yes
Karst Survey	Yes	Yes	No*	No*
Section 7 Consultation	Yes	Yes	Possible	Yes
Instream Flow Studies	Yes	Yes	No	No
Environmental Mitigation	Yes	Possible	Possible	Possible
Mitigation Land Evaluation Program (HEP) (\$)	15,000	20,000	-	-
Land Costs (\$/acre)	5,000	5,000	-	-
Management (\$/Year)	9,350	10,750	4,780	2,160
Archeological, Historical, and Geomorphological Survey (\$)	68,000	77,500	34,500	15,500
Testing for National Register Eligibility (\$)	200,000	200,000	100,000	50,000
Cultural Resources Mitigation, USCE Permit (\$)	400,000	400,000	200,000	100,000
<b>TOTAL COST (\$)</b>	<b>788,000</b>	<b>802,500</b>	<b>384,500</b>	<b>190,500</b>

\* A karst survey has already been performed.

Table 7. (Concluded)

	San Geronimo Creek	Salado Creek	Deep Creek	Culebra Creek	Limekiln Creek
100 % Normal Pool Elevation/ Surface Area (MSL / acres)	1,083 / 183	1,018.3 / 247	1,065 / 65	1,093.1 / 49	1,094 / 28
Recharge Type	2	2	2	2	2
Environmental Reports (\$)	10,000	15,000	10,000	10,000	10,000
Threatened/Endangered Species Survey	Yes	Yes	Yes	Yes	Yes
Karst Survey	Yes	Yes	Yes	Yes	Yes
Section 7 Consultation	Possible	Possible	Possible	Possible	Possible
Instream Flow Studies	No	No	No	No	No
Environmental Mitigation	Possible	Possible	Possible	Possible	Possible
Mitigation Land Evaluation Program (HEP) (\$)	-	-	-	-	-
Land Costs (\$)	-	-	-	-	-
Management (\$/Year)	1,830	2,470	650	490	280
Archeological, Historical, and Geomorphological Survey (\$)	13,000	18,000	5,100	3,600	2,200
Testing for National Register Eligibility (\$)	50,000	50,000	50,000	50,000	50,000
Cultural Resources Mitigation, USCE Permit (\$)	100,000	100,000	100,000	100,000	100,000
<b>TOTAL COST (\$)</b>	173,000	183,000	165,100	163,600	162,200

\* A karst survey has already been performed.

(This page intentionally left blank)

**APPENDIX C**

**HYDROGEOLOGIC EVALUATION BY  
LBG-GUYTON ASSOCIATES, INC.**

**RECONNAISSANCE-LEVEL  
HYDROGEOLOGIC EVALUATION OF  
PROPOSED RECHARGE ENHANCEMENT  
PROJECTS IN THE GUADALUPE-SAN ANTONIO  
RIVER BASIN, PHASE II**

Prepared for

**TRANS-TEXAS WATER PROGRAM  
WEST CENTRAL STUDY AREA**

December 1997

**LBG-GUYTON ASSOCIATES**  
Professional Ground-Water and Environmental Engineering Services  
1101 S. Capital of Texas Highway, Suite B-220  
Austin, Texas 78746

in association with

**HDR ENGINEERING, INC.**  
2211 South IH-35, Suite 300  
Austin, Texas 78741

## TABLE OF CONTENTS

	<u>Page</u>
INTRODUCTION . . . . .	1
EVALUATION OF SITES . . . . .	2
Previous Investigations . . . . .	2
Methodology . . . . .	3
Depth to Water . . . . .	4
Water-Table Configuration . . . . .	4
Stream Losses . . . . .	5
Vadose Zone . . . . .	5
Soils . . . . .	6
Aquifer Media . . . . .	6
Hydraulic Properties . . . . .	7
Geologic Structure . . . . .	8
PRINCIPAL CONCLUSIONS . . . . .	8
REFERENCES . . . . .	10

**TABLE**  
**(at end of report)**

Hydrogeological Settings

**FIGURE**  
**(at end of report)**

Location of Potential Recharge Reservoirs



**RECONNAISSANCE-LEVEL  
HYDROGEOLOGIC EVALUATION OF  
PROPOSED RECHARGE ENHANCEMENT PROJECTS  
IN THE GUADALUPE-SAN ANTONIO RIVER BASIN, PHASE II**

**INTRODUCTION**

This report describes a hydrogeologic evaluation consisting primarily of office studies of four potential recharge project sites in Bexar, Comal and Hays Counties (see attached figure). The four sites are: Cibolo Creek, San Geronimo Creek, and the Lower and Upper Blanco River with diversion to the existing San Marcos SCS/FRS reservoirs. The purpose of this work was to develop the following: (a) an understanding of hydrogeologic conditions which affect and control ground-water movement at each site; (b) a basis for comparative evaluation of sites with respect to potential for direct recharge; and (c) a ranking of the sites in terms of their relative recharge potential based on hydrogeologic conditions.

A field reconnaissance of the proposed Upper Blanco, Cibolo and San Geronimo recharge project sites was conducted with HDR Engineering, Inc. (HDR) personnel and other subconsultants in October 1994 (see attached figure). During this reconnaissance, the streambeds and/or streambanks of each of the three potential reservoir sites were walked to observe geologic structure, streambed conditions for recharge and soil conditions outside the streambed. In addition, water levels in several nearby wells were measured to determine the relative position of the water table in the Edwards aquifer.

An evaluation of the proposed Upper Blanco site with respect to direct recharge was not performed. It has been proposed that, in the event the Upper Blanco reservoir is constructed, water would be released across the recharge zone downstream and/or be transferred from the Upper Blanco reservoir to the San Marcos SCS/FRS reservoirs for recharge. Field reconnaissance was not conducted at the Lower Blanco or San Marcos SCS/FRS reservoirs by LBG-Guyton staff. Additional discussions in this report on the San Marcos SCS/FRS reservoirs are referring to the combined operation of an Upper Blanco reservoir operated to deliver recharge water to the San Marcos reservoirs.

## EVALUATION OF SITES

The evaluation of the four recharge enhancement projects was completed using the concept of hydrogeologic settings. A hydrogeologic setting is a composite description of eight important geologic and hydrologic factors which affect and control recharge to the Edwards aquifer. These include depth to water, configuration of the water table, stream losses, vadose zone, soils, aquifer media, hydraulic properties and geologic structure. Using the hydrogeologic settings, it is possible to make generalizations and comparisons with regard to the ground-water recharge potential at each site relative to the other sites. Reports and mapping from previous investigations were used, for the most part, to develop the hydrogeologic settings for the four recharge enhancement sites.

### Previous Investigations

To date, there have been numerous ground-water investigations covering individual counties in the study area and three major reports covering the entire study area. The results of these investigations have been published as reports, bulletins, etc. by the Texas Water Development Board (TWDB) and its predecessor agencies, the U. S. Geological Survey (USGS), U. S. Department of Agriculture (USDA), University of Texas at Austin (UT) and consultants.

Two of the three most comprehensive ground-water studies were published by the TWDB (Klemt and others, 1979, and Thorkildsen and McElhaney, 1992), and the third, by Maclay and Small (1986), was published by the TWDB in cooperation with the USGS and San Antonio City Water Board. These reports covered the hydrogeology of the Edwards aquifer in the study area, particularly water levels and hydraulic properties of the aquifer. DeCook's (1963) county report was used to gain a better understanding of the hydrogeology in Hays County.

Several smaller reports by consultants (Espey, Huston & Associates, 1982, and Vandertulip, 1959) were used to estimate streamflow losses. HDR (1994) provided location, topographic and soils maps and tabulations for the field reconnaissance conducted in 1994. These maps and tabulations were also helpful in the evaluation work conducted in

the office. In addition, historical well records and water-level measurements collected by the TWDB and USGS were utilized to develop hydrogeologic settings for the four recharge sites.

The geologic mapping of the study area, published by UT's Bureau of Economic Geology and represented by the San Antonio sheet (1974), Seguin sheet (1974) and Austin sheet (1981) of the Geologic Atlas of Texas, generally helped in understanding the structural geology of the study area. However, the hydrogeologic maps of the Edwards aquifer's outcrop prepared by the USGS in Hays County (Hanson and Small, 1995), Hays and southwestern Travis County (Small and others, 1996), Comal County (Small and Hanson, 1994) and Bexar County (Stein and Ozuna, 1995) were of greater help in understanding the vadose zone, aquifer media and hydraulic properties of the Edwards aquifer in the vicinity of the recharge sites. Soil surveys published by the Soil Conservation Service of the USDA (Batte, 1984, and Taylor and others, 1991) were used to evaluate soil conditions.

### **Methodology**

The approach taken basically involves developing a relative ranking scheme to produce a numerical value called the Hydrogeologic Setting Index, which prioritizes the sites with respect to ground-water recharge (see attached table). The evaluation methodology optimizes the use of previous investigations and data and also utilizes the results of the field reconnaissance work which was conducted in October 1994.

The following system was used to determine the numerical value for the Hydrogeologic Setting Index: (a) each of the eight factors associated with the proposed sites was assigned a numerical rating range which varied between 1 and 4—the higher the rating, the greater the ground-water recharge potential; (b) each factor was given equal importance; and (c) the numerical value was determined by using an additive model. Therefore, the sum of the eight geologic and hydrologic factors determines the numerical value of the Hydrogeologic Setting Index for each of the proposed recharge sites (see attached table).

The following provides a description of each of the geologic and hydrologic factors making up the hydrogeologic setting, and discussion relating to the relative ranking of the proposed recharge sites.

### **Depth to Water**

The depth to water is important primarily because it determines the depth of material through which recharge water must travel before reaching the Edwards aquifer and the amount of head buildup available before the aquifer rejects the additional recharge. In general, there is a greater chance for recharge as the depth to water increases because deeper water levels indicate less chance for rejected recharge (springs, seeps, etc.) below the recharge structure. However, the depth to water is not important at those sites where the recharge pool is located on rocks younger than the Edwards aquifer; recharge may not take place due to the impermeable nature of the overlying sediments, except for artificially induced recharge through these younger sediments—wells, shafts, etc.

The 1961 USGS Edwards aquifer water-level measurements were used to estimate the depth of the water table below the proposed recharge sites. In the case of the three existing San Marcos SCS/FRS recharge reservoirs, the average depth to water was utilized for comparison purposes. Both the SCS/FRS reservoirs and proposed Lower Blanco recharge site were downgraded significantly because of high water levels which were at 36 feet and 24 feet below the sites, respectively.

The San Geronimo recharge site was only slightly downgraded. At this site, the Edwards is represented by 40 to 50 feet of shaly nodular limestones with surface caves and other lateral karst features. In the deeper subsurface, there is very little permeability in these rocks. Water levels appear to be below the base of the aquifer. However, assuming that interconnected karst features exist in the shallow subsurface which can transmit water to the aquifer, it may be possible to increase recharge at this location.

### **Water-Table Configuration**

The water table is the expression of the unconfined water surface below ground level where all the pore and fracture spaces are filled with water. Evidence of possible

water-table mounding below the proposed structure and the direction of ground-water movement toward local springs, seeps, etc. which may divert water away from the main stem of the aquifer were the criteria used in the evaluation.

Only the proposed Lower Blanco recharge site received a reduced ranking because of the possibility of recharge water being discharged in the river below the reservoir.

### **Stream Losses**

Recharge to the Edwards aquifer occurs primarily by infiltration of surface water from streams which traverse the outcrop. HDR provided streamflow losses for the following proposed recharge sites: (a) Lower Blanco, 2.9 cubic feet per second (cfs) per mile; (b) Cibolo Creek, 11.1 cfs per mile; (c) San Geronimo, 9.9 cfs per mile; and (d) San Marcos SCS/FRS reservoirs, streamflow losses assumed to be about the same as the proposed Cibolo Creek site.

The proposed Lower Blanco site was significantly downgraded because of low streamflow losses (2.9 cfs per mile). The San Geronimo site was slightly downgraded because its estimated recharge rate is less than the San Marcos SCS/FRS reservoirs. HDR assumed that streamflow losses at the San Geronimo site would be about the same as those for the proposed Lower Verde reservoir (located about 9 miles north of Hondo, Medina County, Texas). However, based on field reconnaissance of the Lower Verde site (June 1993) and San Geronimo site (October 1994), it is our firm's opinion that streamflow losses for the San Geronimo site would be less than those associated with the Lower Verde site.

### **Vadose Zone**

The vadose zone is defined as that zone above the water table which is unsaturated. The type of vadose-zone media determines the recharge characteristics of the material below the soil horizon and above the water table.

The proposed San Geronimo site received a slightly lower ranking because it is not known to what depth karstification and cave development have occurred in the basal Edwards rocks at this site. Without karstification to develop secondary porosity, these

rocks would consist of nodular clayey mudstones and limestones with very little matrix permeability. The rating of the proposed Lower Blanco site was lowered significantly because approximately 20 to 30 percent of the rocks which outcrop at the site are younger than the Edwards and act as confining intervals which overlie the aquifer and restrict the downward percolation of water.

### **Soils**

Soil is considered the uppermost portion of the vadose zone. The type of soils found at the recharge site within the area of impoundment has a significant impact on the amount of recharge which can infiltrate into the ground and hence on the ability of recharged water to move vertically into the vadose zone.

The following observations are based on a review of the soil surveys and field reconnaissance of the Cibolo Creek and San Geronimo recharge sites: (a) at the existing San Marcos SCS/FRS reservoirs, and proposed Cibolo Creek and Lower Blanco sites, very shallow to moderately deep, undulating to steep and hilly clay soils over indurated limestones occur; (b) near the dam at the proposed Lower Blanco site, deep clay and fine sandy loam soils occur which act to restrict the downward percolation of water; (c) at the proposed San Geronimo site, the clay soils are more thick, loamy, gravelly and calcareous, and slightly more permeable than the other three sites; and (d) although there are minor differences, the soil associations found at the four recharge sites would be classified as slowly to moderately permeable soils.

The Lower Blanco recharge site was downgraded slightly because of the deep clay and sandy loam soils found near the proposed dam. The San Geronimo recharge site received a somewhat lower ranking because the soil profile over the Edwards limestone at the site appeared much thicker and well developed than at the other sites. A thick soil profile would limit the amount of recharge which could infiltrate into the ground.

### **Aquifer Media**

Aquifer media refers to the porous and permeable nature of the geologic materials which serve as the aquifer (such as fractured and porous limestones versus uniform and

dense limestones). The route the water will take from the recharge site can be strongly influenced by fracturing or other features such as an interconnected series of solution openings, which may provide pathways for easier flow.

Both the proposed Lower Blanco and San Geronimo recharge sites received lower rankings. These sites were downgraded because of the following: (a) the Lower Blanco site was slightly downgraded because of impermeable younger than Edwards rocks which are present in the vicinity of the dam below the water table; and (b) the San Geronimo site was significantly downgraded because the Edwards aquifer is not water-saturated (the water table is below the base of the aquifer) and the Edwards rocks which are present in the subsurface may have negligible porosity and permeability. At the San Geronimo site, it is assumed that recharge water may move in the shallow basal Edwards rocks (vadose zone) from the proposed recharge pool to the aquifer across one or more fault blocks before moving laterally into more permeable and younger Edwards rocks which have been downfaulted east of the site.

### **Hydraulic Properties**

The transmissivity of an aquifer generally refers to the ability of the aquifer materials to transmit water, which in turn controls the rate at which recharged ground water will move away from the point at which it enters the aquifer. The transmissivity of the Edwards aquifer is primarily controlled by the amount and interconnection of void spaces within the aquifer.

The transmissivities used in the TWDB's Edwards aquifer flow model (Thorkildsen and McElhaney, 1992) were used to rank the proposed sites. Two of the proposed site transmissivities fell within the 10,000 to 100,000 gallons per day per foot (gpd/ft) range, the exceptions being the San Geronimo site (less than 10,000 gpd/ft) and Cibolo Creek site (1 million to 10 million gpd/ft). Klemt and others (1979) estimated the transmissivity of the San Marcos SCS/FRS and the Lower Blanco sites to be on the order of 90,000 gpd/ft and 20,000 gpd/ft, respectively.

The Cibolo Creek site received the highest rating. The San Marcos SCS/FRS reservoirs were downgraded only slightly. Both the Lower Blanco and San Geronimo sites were downgraded significantly because of low TWDB model transmissivities.

The following provides rough estimates of vertical hydraulic conductivity values for the four proposed recharge sites: (a) Cibolo Creek site, 700 feet per day (ft/day); (b) San Marcos SCS/FRS sites, 30 ft/day; (c) Lower Blanco site, 10 ft/day. These values are based on TWDB model transmissivities and the assumptions that the aquifer is unconfined, homogeneous and saturated, and that the aquifer's hydraulic conductivity is equal in the horizontal and vertical directions. If the assumption is made that the basal Edwards rocks are water-saturated at the San Geronimo site (approximately 40 to 50 feet), the vertical hydraulic conductivity would be on the order of 10 to 20 ft/day.

### **Geologic Structure**

Structure refers to those geologic and hydrologic features (faults, fracture zones, sinkholes, lineations, etc.) that are associated with large openings in the Edwards rocks and which create conditions favorable for recharge. All of the proposed sites appear to be favorable for artificial recharge based on available geological mapping and observed structural features in the field.

## **PRINCIPAL CONCLUSIONS**

1. Artificial recharge is presently taking place at the three San Marcos SCS/FRS reservoirs with good success.
2. The proposed Cibolo Creek recharge project appears to be the most favorable site for the development of recharge enhancement based on the hydrogeologic settings evaluation.



3. The three existing San Marcos SCS/FRS reservoirs are favorable for the impoundment of additional recharge waters from the proposed Lower or Upper Blanco sites.
4. The proposed Lower Blanco recharge reservoir does not appear to be favorable for direct recharge enhancement. There is a good chance that a large portion of water which may be recharged to the Edwards aquifer would be rejected below the site. However, as with the Upper Blanco site, water could be diverted from the Lower Blanco site to the San Marcos SCS/FRS reservoirs for recharge enhancement.
5. The proposed San Geronimo recharge project appears to be marginal with respect to the proposed construction and impoundment of additional recharge waters. Additional study will be required to resolve the issues associated with depth of karstification and cave development.

## REFERENCES

- Batte, C. D., 1984, Soil survey of Comal and Hays Counties, Texas: U. S. Department of Agriculture, Soil Conservation Service in cooperation with Texas Agriculture Experiment Station.
- DeCook, K. J., 1963, Geology and ground-water resources of Hays County, Texas: U. S. Geological Survey Water-Supply Paper 1612.
- Espey, Huston & Associates, Inc., 1982, Feasibility study of recharge facilities on Cibolo Creek: draft report prepared for the Edwards Underground Water District.
- Hanson, J. A., and Small, T. A., 1995, Geologic framework and hydrogeologic characteristics of the Edwards aquifer outcrop, Hays County, Texas: U. S. Geological Survey Water-Resources Investigations Report 95-4265 prepared in cooperation with the Edwards Underground Water District.
- HDR Engineering, Inc., 1994, Guadalupe-San Antonio River Basin recharge enhancement study, phase II: maps, photos and tables for the field reconnaissance of the Upper Blanco, Cibolo Creek and San Geronimo project sites, October 25 and 26, 1994, prepared in cooperation with the Edwards Underground Water District.
- Klemt, W. B., Knowles, T. R., Elder, G. R., and Sieh, T. W., 1979, Ground-water resources and model applications for the Edwards (Balcones fault zone) aquifer in the San Antonio region, Texas: Texas Department of Water Resources Report 239.
- Maclay, R. W., and Small, T. A., 1986, Carbonate geology and hydrology of the Edwards aquifer in the San Antonio area, Texas: Texas Water Development Board Report 296.
- Small, T. A., and Hanson, J. A., 1994, Geologic framework and hydrogeologic characteristics of the Edwards aquifer outcrop, Comal County, Texas: U. S. Geological Survey Water-Resources Investigations Report 94-4117 prepared in cooperation with the Edwards Underground Water District.
- Small, T. A., Hanson, J. A., and Hauwert, N. M., 1996, Geologic framework and hydrogeologic characteristics of the Edwards aquifer outcrop (Barton Springs segment), northeastern Hays and southwestern Travis Counties, Texas: U. S. Geological Survey Water-Resources Investigations Report 96-4306 prepared in cooperation with the Barton Springs/Edwards Aquifer Conservation District and the Texas Water Development Board.

- Stein, W. G., and Ozuna, G. B., 1995, Geologic framework and hydrogeologic characteristics of the Edwards aquifer recharge zone, Bexar County, Texas: U. S. Geological Survey Water-Resources Investigations Report 95-4030 prepared in cooperation with the San Antonio Water System.
- Taylor, F. B., Hailey, R. B., and Richmond, D. L., 1991, Soil survey of Bexar County, Texas: U. S. Department of Agriculture, Soil Conservation Service in cooperation with Texas Agricultural Experiment Station.
- The University of Texas at Austin, Bureau of Economic Geology, 1974, Geologic atlas of Texas, San Antonio sheet: scale 1:250,000.
- The University of Texas at Austin, Bureau of Economic Geology, 1974, Geologic atlas of Texas, Seguin sheet: scale 1:250,000.
- The University of Texas at Austin, Bureau of Economic Geology, 1981, Geologic atlas of Texas, Austin sheet: scale 1:250,000.
- Thorkildsen, David, and McElhaney, P. D., 1992, Model refinement and applications for the Edwards (Balcones fault zone) aquifer in the San Antonio region, Texas: Texas Water Development Board Report 340.
- Vandertulip, J. J., 1959, Analysis of seepage runs, Guadalupe River and Blanco River: memorandum to Robert L. Lowry, consulting engineer, Austin, Texas.

## HYDROGEOLOGICAL SETTINGS



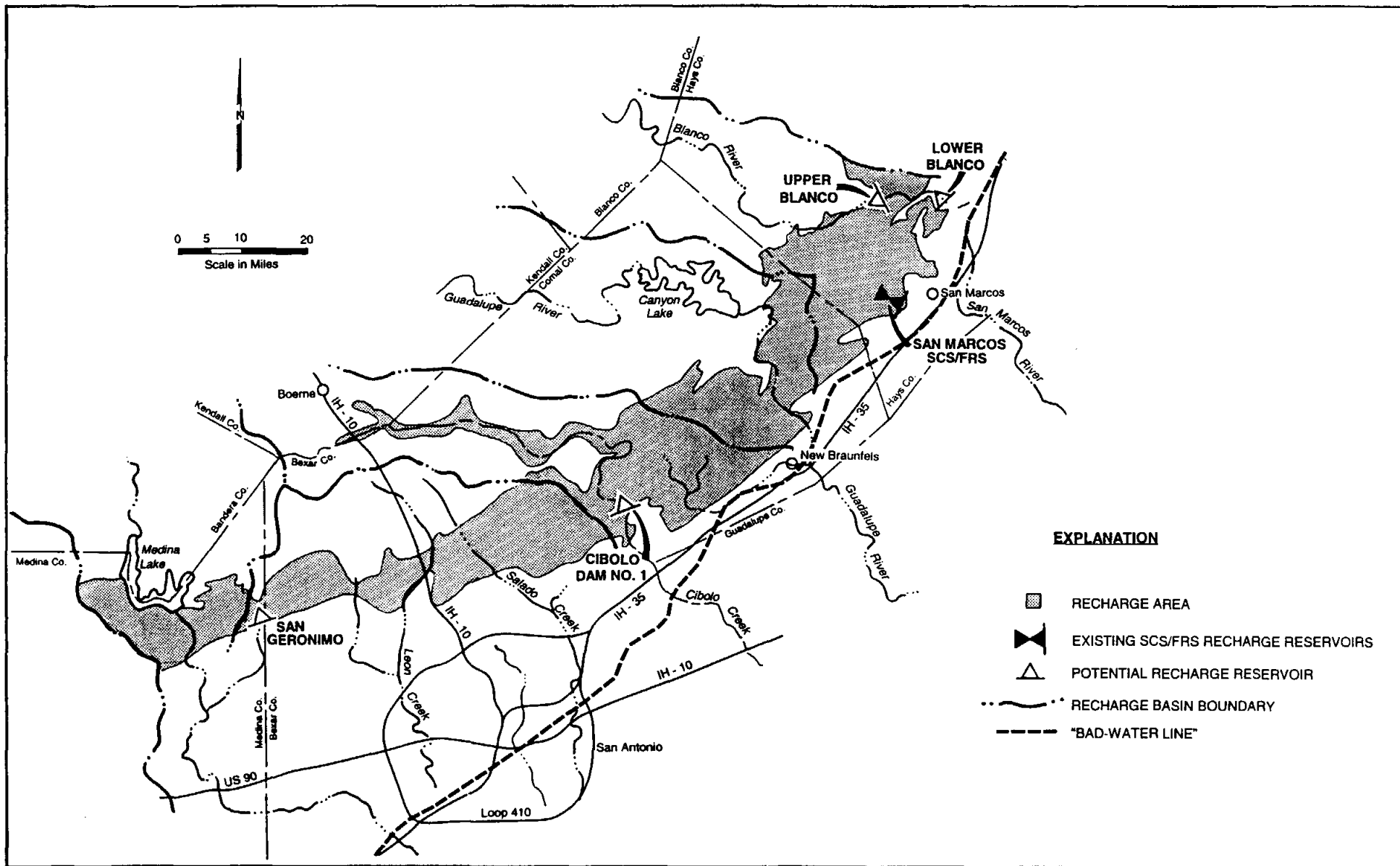

Geologic and Hydrologic Factors	Recharge Reservoirs			
	Upper Blanco <sup>1/</sup>	Lower Blanco <sup>2/</sup>	Cibolo Creek <sup>2/</sup>	San Geronimo Creek <sup>3/</sup>
Depth to Water	2	2	4	3
Water-Table Configuration	4	3	4	4
Streamflow Losses	4	2	4	3
Vadose Zone	4	2	4	3
Soils	4	3	4	3
Aquifer Media	4	3	4	2
Vertical Hydraulic Properties	3	2	4	2
Geologic Structure	4	4	4	4
TOTAL	29	21	32	24

**FOOTNOTES:**

- <sup>1/</sup> Operated in conjunction with three existing SCS/FRS reservoirs in the Upper San Marcos watershed.
- <sup>2/</sup> Potential recharge project.
- <sup>3/</sup> New project upstream of existing recharge project.





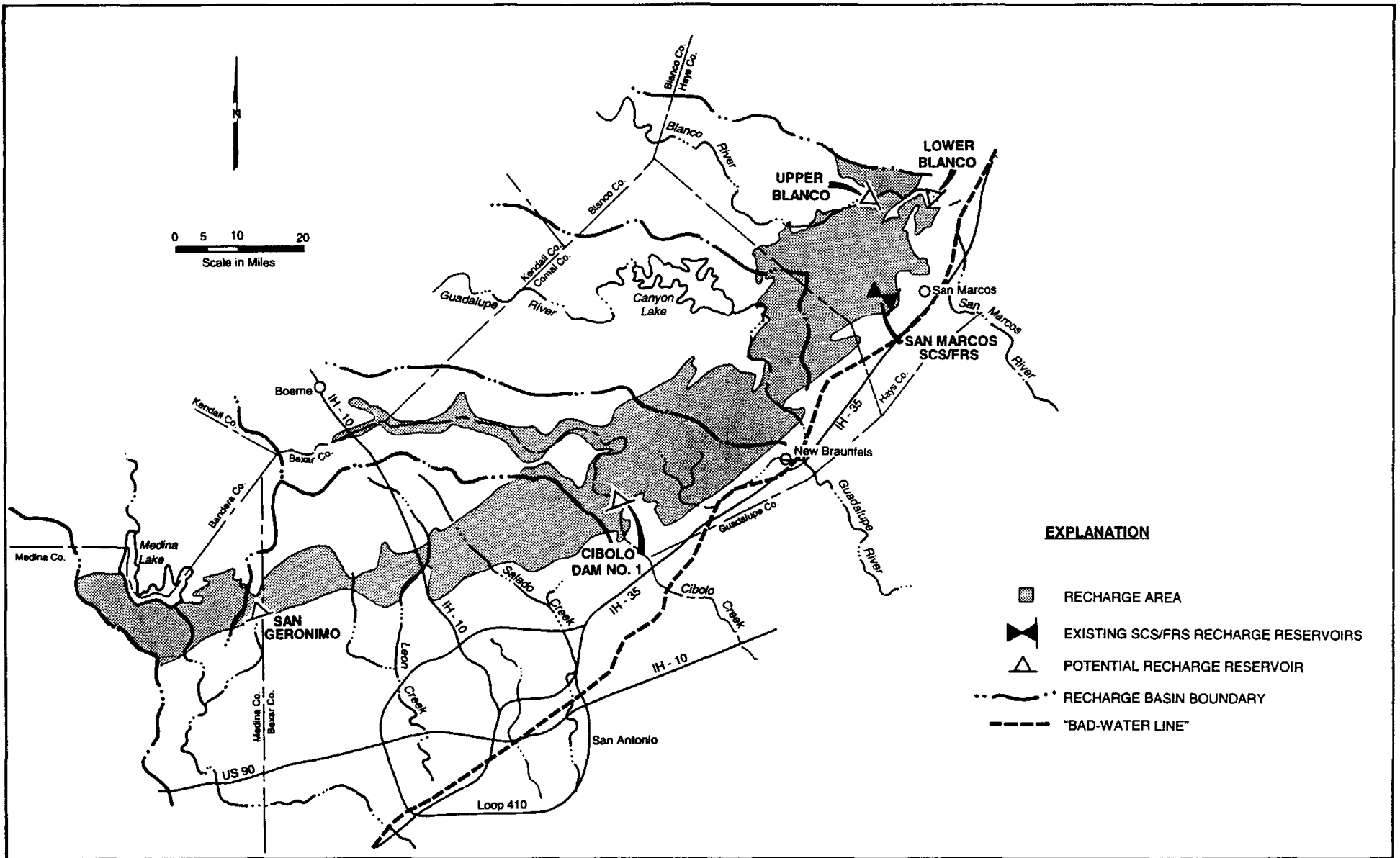

**EXPLANATION**

-  RECHARGE AREA
-  EXISTING SCS/FRS RECHARGE RESERVOIRS
-  POTENTIAL RECHARGE RESERVOIR
-  RECHARGE BASIN BOUNDARY
-  "BAD-WATER LINE"

LOCATION OF POTENTIAL RECHARGE RESERVOIRS



**EXPLANATION**

-  RECHARGE AREA
-  EXISTING SCS/FRS RECHARGE RESERVOIRS
-  POTENTIAL RECHARGE RESERVOIR
-  RECHARGE BASIN BOUNDARY
-  "BAD-WATER LINE"

**LOCATION OF POTENTIAL RECHARGE RESERVOIRS**

## **Report 2**

# **Conceptual Evaluation of Springflow Recirculation**

**TRANS-TEXAS WATER PROGRAM  
WEST CENTRAL STUDY AREA**

**PHASE 2**

**CONCEPTUAL EVALUATION OF  
SPRINGFLOW RECIRCULATION**

**San Antonio River Authority  
San Antonio Water System  
Edwards Aquifer Authority  
Guadalupe-Blanco River Authority  
Lower Colorado River Authority  
Bexar Metropolitan Water District  
Nueces River Authority  
Canyon Lake Water Supply Corporation  
Bexar-Medina-Atascosa Counties WCID No. 1  
Texas Natural Resource Conservation Commission  
Texas Parks and Wildlife Department  
Texas Water Development Board**

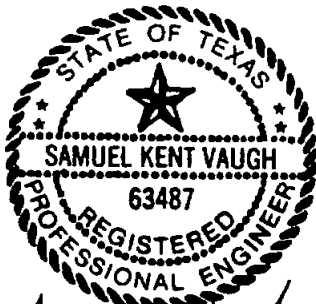

*Samuel K Vaughn*  
3/25/98

**HDR**  
HDR Engineering, Inc.

March 1998



*Larry F. Land*  
March 25, 1998



*Kenneth L. Choffel*  
3/25/1998



# CONCEPTUAL EVALUATION OF SPRINGFLOW RECIRCULATION

## TABLE OF CONTENTS

Section	Page
<b>1.0 INTRODUCTION</b> .....	1-1
<b>2.0 SPRINGFLOW RECIRCULATION CONCEPT</b> .....	2-1
<b>2.1 Framework</b> .....	2-1
<b>2.2 Models</b> .....	2-4
2.2.1 Ground Water.....	2-4
2.2.2 Surface Water.....	2-9
<b>2.3 Evaluation</b> .....	2-10
2.3.1 Aquifer Performance.....	2-10
2.3.2 Streamflow and Fisheries Harvest .....	2-11
<b>3.0 CONCEPTUAL MANAGEMENT PLANS</b> .....	3-1
<b>3.1 Pumpage of 400,000 acft/yr</b> .....	3-1
3.1.1 Ground Water.....	3-1
3.1.2 Surface Water.....	3-16
<b>3.2 “Sustained Yield” Pumpage</b> .....	3-23
3.2.1 Ground Water.....	3-23
3.2.2 Surface Water.....	3-37
<b>4.0 DISCUSSION OF GROUND WATER MODELING RESULTS</b> .....	4-1
<b>5.0 PROJECT ENGINEERING AND COST ESTIMATES</b> .....	5-1
<b>6.0 SUMMARY</b> .....	6-1
<b>7.0 CONCLUSIONS AND RECOMMENDATIONS</b> .....	7-1
<b>Appendix</b>	
<b>A GUADALUPE ESTUARY DATA</b> .....	A-1

## LIST OF FIGURES

Figure No.	Page
2.1-1 Water Diversion and Delivery Locations.....	2-3
2.1-2 Pipeline Route and Recharge Sites, 200 cfs Recirculation Rate.....	2-5
2.1-3 Pipeline Route and Recharge Sites, 400 cfs Recirculation Rate.....	2-6
2.2-1 GWSIM4 Model for Edwards Aquifer .....	2-7
3.1-1 Recirculated Springflow, 400,000 acft/yr Aquifer Pumpage.....	3-2
3.1-2 Water Budget, 400,000 acft/yr Pumpage.....	3-4
3.1-3 Computed Flow from Comal Springs for 400,000 acft/yr Pumpage.....	3-6
3.1-4 Computed Flow from Major Springs of Edwards Aquifer 400,000 acft/yr Pumpage.....	3-9
3.1-5 Computed Change in Flow, Guadalupe River After Diversion, 400,000 acft/yr Pumpage .....	3-11
3.1-6 Computed Water Levels at Index Wells, 400,000 acft/yr Pumpage.....	3-13
3.1-7 Computed Water Levels at J-17 Index Well, 400,000 acft/yr Pumpage.....	3-15
3.1-8 Computed Water Levels at Uvalde Index Well, 400,000 acft/yr Pumpage.....	3-17
3.1-9 Median Monthly Streamflows, Guadalupe- San Antonio River Basin, 400,000 acft/yr Pumpage .....	3-18
3.1-10 Flow Frequency Curves, Guadalupe- San Antonio River Basin, 400,000 acft/yr Pumpage .....	3-20
3.2-1 Recirculated Springflow, “Sustained Yield” Pumpage.....	3-24
3.2-2 Water Budget, “Sustained Yield” Pumpage.....	3-26
3.2-3 Computed Flow from Comal Springs, “Sustained Yield” Pumpage.....	3-28
3.2-4 Computed Flow from Major Springs of Edwards Aquifer, “Sustained Yield” Pumpage.....	3-30
3.2-5 Computed Change in Flow, Guadalupe River After Diversion, “Sustained Yield” Pumpage.....	3-31
3.2-6 Computed Water Levels at Index Wells, “Sustained Yield” Pumpage .....	3-33
3.2-7 Computed Water Levels at J-17 Index Well, “Sustained Yield” Pumpage .....	3-35
3.2-8 Computed Water Levels at Uvalde Index Well, “Sustained Yield” Pumpage .....	3-36
3.2-9 Median Monthly Streamflows, Guadalupe- San Antonio River Basin, “Sustained Yield” Pumpage.....	3-38
3.2-10 Flow Frequency Curves, Guadalupe- San Antonio River Basin, “Sustained Yield” Pumpage.....	3-40

## LIST OF TABLES

<b>Table No.</b>	<b>Page</b>
3.1-1 Summary of Water Rights Shortages and Canyon Reservoir Firm Yield for 400,000 ac-ft/yr pumpage .....	3-21
3.1-2 Summary of Fisheries Harvest Estimates for the Guadalupe Estuary for 400,000 ac-ft/yr Pumpage .....	3-22
3.2-1 Summary of Water Rights Shortages and Canyon Reservoir Firm Yield for “Sustained Yield” Pumpage .....	3-39
3.2-2 Summary of Fisheries Harvest Estimates for the Guadalupe Estuary “Sustained Yield” Pumpage.....	3-41
5.1-1 Cost Estimate Summaries for 400,000 ac-ft/yr Aquifer Pumpage with up to 200 cfs Diversions from Lake Dunlap to Northwestern Bexar County.....	5-3
5.1-2 Cost Estimate Summaries for 400,000 ac-ft/yr Aquifer Pumpage with up to 400 cfs Diversions from Lake Dunlap and Gonzales and Recharge to Northwestern Bexar County and Northern Medina County .....	5-4
5.1-3 Cost Estimate Summaries for “Sustained Yield” Aquifer Pumpage with up to 200 cfs Diversions from Lake Dunlap to Northwestern Bexar County.....	5-5
5.1-4 Cost Estimate Summaries for “Sustained Yield” Aquifer Pumpage with up to 400 cfs Diversions from Lake Dunlap and Gonzales and Recharge to Northwestern Bexar County and Northern Medina County .....	5-6

(This page intentionally left blank.)

## 1.0 INTRODUCTION

Over the past few years, several concepts for increasing the available water supply from the Edwards Aquifer and/or enhancing water levels during droughts to maintain springflows have been identified. One of the concepts is the construction of recharge enhancement reservoirs on streams in the recharge zone. A second concept which could have significant potential benefit is springflow recirculation and is the subject of this report.

The purpose of this report is to present an evaluation of conceptual springflow recirculation plans under which water from Comal Springs or Comal and San Marcos Springs would be used to recharge the San Antonio portion of the Edwards Aquifer. The evaluation consists of estimating the changes that springflow recirculation would have on (1) pumpage, springflow, and water levels in the Edwards Aquifer, (2) water rights in the Guadalupe River, and (3) freshwater inflows and fisheries harvest in the Guadalupe Estuary. This report represents a reconnaissance level evaluation of the concept and is intended to portray the overall water supply benefits and costs associated with potential springflow recirculation projects.

(This page intentionally left blank.)

## 2.0 SPRINGFLOW RECIRCULATION CONCEPT

Springflow recirculation from Comal Springs and San Marcos Springs to the recharge zone of the Edwards Aquifer in the San Antonio area has been advanced as having a significant potential to: (1) increase the amount of water available for pumpage, (2) to stabilize and or enhance aquifer water levels, and (3) to maintain springflow during droughts (HDR, Inc., January 1996).<sup>1</sup> In general, springflow recirculation involves diverting a portion of the water in the Guadalupe River which originates as springflow back to the recharge zone of the Edwards Aquifer where it would be released to streams that naturally recharge the aquifer. This springflow recharge would migrate through the aquifer along with the natural recharge and would eventually be discharged by wells or springs. The operational premise is to fill the aquifer during periods when there is plenty of springflow. Then, during drought, the stored water would sustain aquifer pumpage at established rates and help maintain springflows above critical levels.

This study evaluates two management plans. One plan sets Edwards Aquifer pumpage at 400,000 acre-feet (ac-ft) per year which is the base level set for the region after the year 2008. For this fixed level of pumpage, springflow recirculation would benefit the springs by reducing or eliminating the percentage of time when flows would be below critical levels. The second management plan sets long-term aquifer pumpage at a rate equal the “sustained yield” which is defined for this conceptual evaluation as the long-term pumping rate that does not cause the flow from Comal Springs to go below 60 cfs during the worst month of the 1950s drought. The principal feature of this management plan is that allowable aquifer pumpage increases as the amount of springflow recirculation is increased. In both plans, the annual pumpage is constant throughout the 1934 to 1989 test period; but, monthly pumpage varies in a constant pattern from year to year.

### 2.1 Framework

The approach for estimating the benefits and impacts of the two management plans involves application of a mathematical computer model of the Edwards Aquifer to predict water levels and springflows. For the first management plan, Edwards Aquifer pumpage was set at 400,000 ac-ft/yr; for the second management plan, the pumpage was set at a fixed rate

---

<sup>1</sup> HDR, Engineering Inc., “West Central Study Area Phase I Interim Report”, Volume 4, January, 1996

("sustained yield") that ensured a minimum of 60 cubic feet per second (cfs) flowing from Comal Springs during the most severe drought on record. Under each of these management plans, three computer model simulations were performed. The first simulation is without springflow recirculation and provides a baseline for computing changes or enhancements for model runs with recirculation. The second simulation includes a maximum recirculation rate of 200 cfs, but water for recirculation is considered to only be available when Comal Springs is flowing 60 cfs or more. Thus, the amount of water available for recirculation is the amount of flow from Comal Springs that is between 60 and 260 cfs. For purposes of estimating the cost of facilities for this plan, this water is assumed to be pumped from Lake Dunlap on the Guadalupe River which is about 5 miles downstream from Comal Springs (Figure 2.1-1). The third simulation includes a maximum recirculation rate of 400 cfs, with a minimum combined flow from Comal and San Marcos Springs of 160 cfs being left in the Guadalupe River. For cost estimating purposes, it was assumed that up to 200 cfs would be pumped from the Lake Dunlap site, and that up to 200 cfs more will be pumped from the Guadalupe River below the mouth of the San Marcos River near Gonzales (Figure 2.1-1).

The selection of target streams to recharge the aquifer by recirculated springflow is based on several factors. Four of the major ones are: (1) the time delay between the recharge in the outcrop and discharge at major springs, (2) streams and their reaches that are conducive to water losses to the Edwards Aquifer, (3) location of existing or proposed recharge structures on the streams (HDR, Inc., June 1994),<sup>2</sup> and (4) expected capital and operating costs. Considering the hydrogeology, storage and flow units of the Edwards Aquifer (Maclay and Land, 1987),<sup>3</sup> recharge east of the Bexar - Medina County line tends to move directly toward the northeast and Comal and San Marcos Springs while recharge west of this county line tends to move toward the southwest before turning toward San Antonio and then to Comal and San Marcos Springs. Because of these aquifer circulation patterns, recharge in Bexar County is expected to show a relatively short time response in Comal Springs while recharge in Medina County would have a delayed response. Considering the goal of increasing the availability of water for pumpage and

---



<sup>2</sup> HDR Engineering, Inc., "Edwards Aquifer Recharge Enhancement Project Phase IVA, Nueces River Basin", June 1994.

<sup>3</sup> Maclay, R.W., and Land, L.F., 1988, Simulation of flow in the Edwards Aquifer, San Antonio region, Texas, a refinement of storage and flow concepts: U.S. Geological Survey Water Supply Paper 2336, 48p.

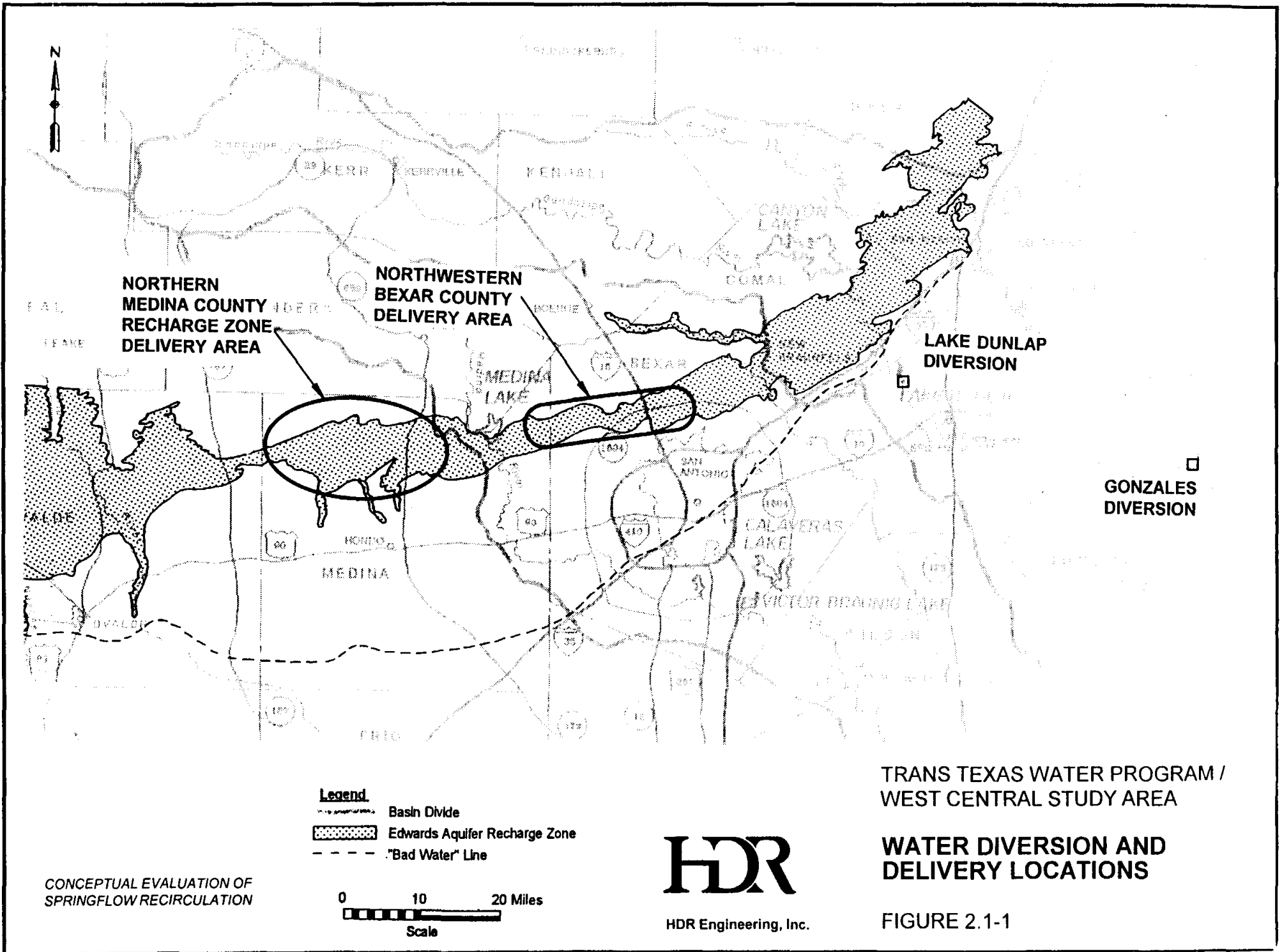



CONCEPTUAL EVALUATION OF  
SPRINGFLOW RECIRCULATION

- Legend**
-  Basin Divide
  -  Edwards Aquifer Recharge Zone
  -  "Bad Water" Line



HDR Engineering, Inc.

TRANS TEXAS WATER PROGRAM /  
WEST CENTRAL STUDY AREA

**WATER DIVERSION AND  
DELIVERY LOCATIONS**

FIGURE 2.1-1

maintaining springflows above critical levels, streams in Bexar County were selected for recharge when springflow recirculation rates are a maximum of 200 cfs. For recirculation rates up to 400 cfs, the first 200 cfs was recharged in streams in Bexar County and the remaining water was recharged in streams in Medina County including Verde Creek, Hondo Creek, Parker Reservoir and Seco Creek. General water delivery locations were shown in (Figure 2.1-1).

The major facilities to transport the water are shown in Figures 2.1-2 and 2.1-3 and include: surface water intake structures, variable speed pumping stations, pipelines with booster stations, and existing, and/or new recharge enhancement dams.

## **2.2 Models**

### **2.2.1 Ground Water**

The Texas Water Development Board (TWDB) GWSIM4 Edwards Aquifer ground water flow model (Figure 2.2-1) is used to simulate the response of water levels and springflows to specified recharge and pumpage rates. The model was first developed by the TWDB in the 1970s (Klemt and others, 1979)<sup>4</sup> as a tool for use in developing a water resources management program for the Nueces, San Antonio, Guadalupe, and Blanco River basins. Originally, the model operated on an annual time step and was calibrated to data collected during 1947-1971. The TWDB recalibrated the model in the early 1990s with information compiled between 1971 and 1989 and refined the time step to monthly intervals (Thorkildsen and McElhaney, 1992).<sup>5</sup> The recalibration was based on comparisons of water levels and springflows for 1947-1959 and verified with 1978 to 1989 data. During the process of adjusting the aquifer parameters for a recalibration, the model developers gave special emphasis to minimum flow periods at Comal and San Marcos Springs. The recalibration did not revise any of the major assumptions made in the original model which included: (1) no lateral movement of water from the Glen Rose Formation in the Hill Country (Trinity Aquifer—Edwards Plateau), (2) no water movement

---

<sup>4</sup> Klemt, W.B., Knowles, T.R., Elder, G.R., and Sieh, T.W., 1979, Ground-water resources and model applications for the Edwards (Balcones Fault Zone) Aquifer in the San Antonio region, Texas: Texas Water Development Board Report 239, 88p.

<sup>5</sup> Thorkildsen, D. and McElhaney, P.D., 1992, Model refinement and applications for the Edwards (Balcones Fault Zone) Aquifer in the San Antonio Region, Texas: Texas Water Development Board Report 340, 33p.

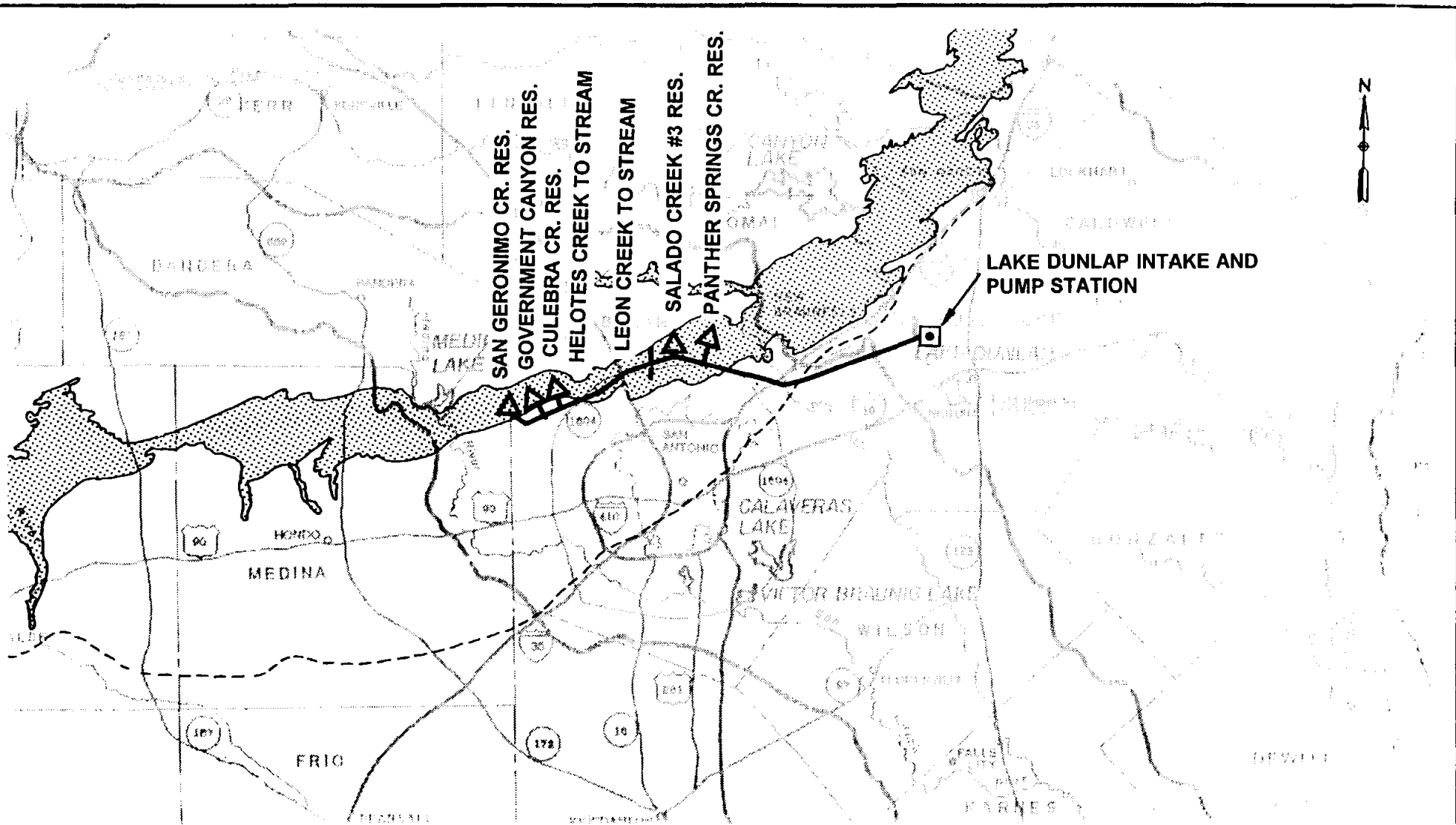

**LEGEND:**

- ..... LATERAL TO RECHARGE SITE
- 200 CFS PIPELINE CAPACITY
- ▲ RECHARGE DETENTION RESERVOIR

CONCEPTUAL EVALUATION OF  
SPRINGFLOW RECIRCULATION



HDR Engineering, Inc.

TRANS TEXAS WATER PROGRAM /  
WEST CENTRAL STUDY AREA

**PIPELINE ROUTE AND  
RECHARGE SITES**  
200 CFS RECIRCULATION RATE

FIGURE 2.1-2



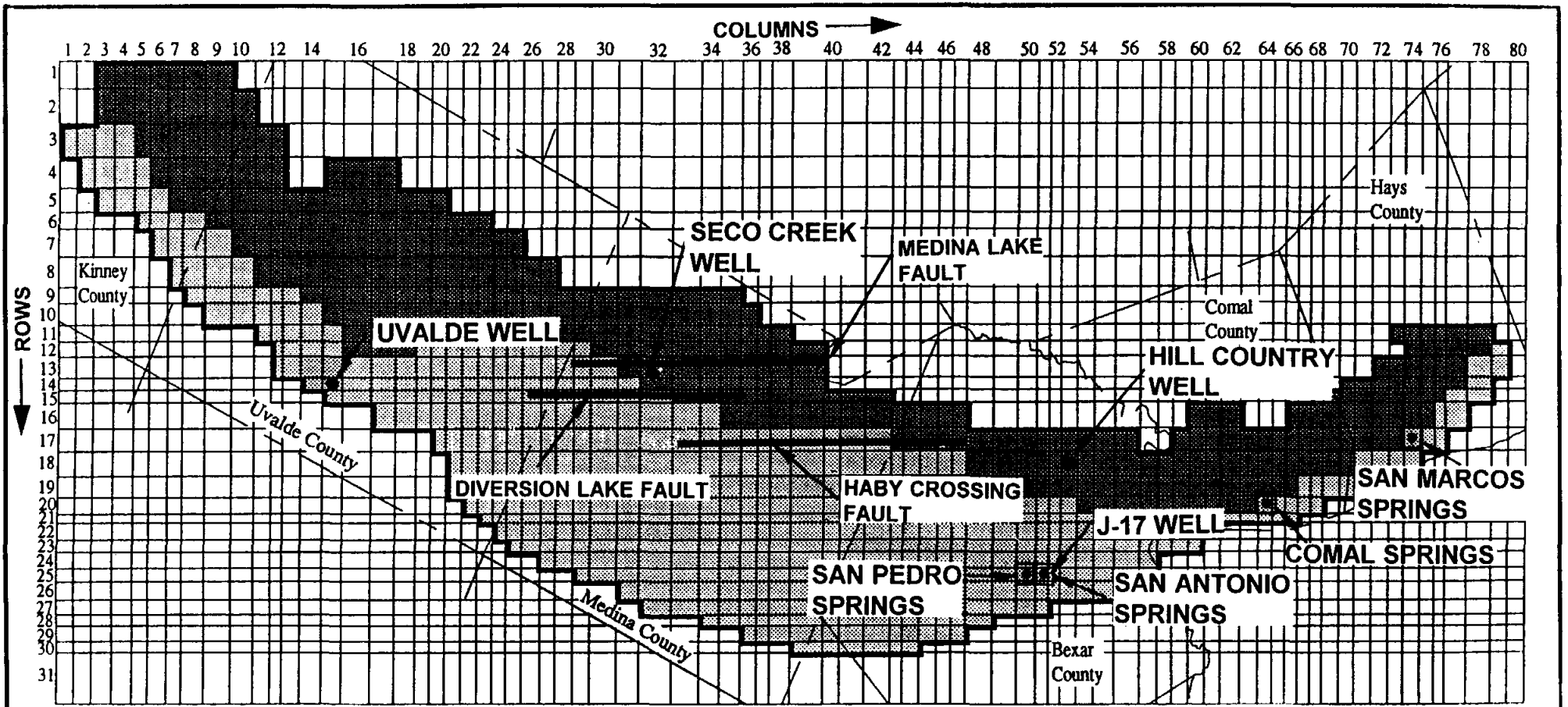

**LEGEND:**

- NO FLOW BOUNDARY
- OUTCROP CELL
- ARTESIAN WELL
- SPRING
- WELL

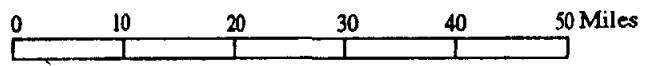

CONCEPTUAL EVALUATION OF  
SPRINGFLOW RECIRCULATION



HDR Engineering, Inc.

TRANS TEXAS WATER PROGRAM /  
WEST CENTRAL STUDY AREA

**GWSIM 4 MODEL FOR  
EDWARDS AQUIFER**

FIGURE 2.2-1

across the so-called 'bad water line', and (3) no leakage from underlying or overlying formations except for an area southeast of Uvalde near Leona Springs.

All model simulations for this study began in 1934 and ended in 1989. The period includes a severe drought in the 1950s and wetter than normal conditions in the 1980s, except for short-term, but intense droughts in 1984 and 1989. The natural recharge to the model is based on monthly estimates developed by HDR<sup>6,7</sup> and distributions within watersheds as estimated by the TWDB. The losses of water from the model are (1) pumpage that is assigned to specific locations at monthly rates by TWDB, (2) springflow (Leona, San Pedro, San Antonio, Comal, and San Marcos Springs) that is calculated from aquifer heads and an aquifer head-springflow rating curve for each spring, and (3) cross formational leakage in an area southeast of Uvalde. Starting water levels are based on 1994 conditions and were derived by TWDB.

For purposes of this study, the GWSIM4 model was modified to: (1) calculate the amount of springflow potentially available for recirculation at rates up to 200 cfs and 400 cfs, (2) turn the springflow recirculation 'ON' or 'OFF' on the basis of ground water levels at index monitoring wells located near the two recharge areas, (3) distribute and add the available recirculated water at the end of a given month to the natural recharge during the following month at pre-selected recharge sites, and (4) provide user-specified summaries of results for analysis of aquifer performance.

In simulating springflow recirculation, the model allows for three possibilities. One is a baseline with no recirculated water. The second possibility is for a recirculation rate of up to 200 cfs when flows from Comal Springs are in excess of 60 cfs. The third possibility is for a recirculation rate up to 400 cfs when combined flows from Comal and San Marcos Springs are in excess of 160 cfs. Before water is allowed to be recirculated, a test is made to determine whether the water level in an index well near the appropriate recharge area is above or below specified levels. If the water level is below a minimum specified level, a signal indicating a need for recharge activates recirculation. If the water level is above a maximum specified level, a signal

---

<sup>6</sup> HDR Engineering, Inc., "Guadalupe-San Antonio's River Basin Recharge Enhancement Study," Edwards Underground Water District, September, 1993.

<sup>7</sup> HDR Engineering, Inc., "Nueces River Basin Regional Water Supply Planning Study," Nueces River Authority, et al., May, 1991.

indicates that the aquifer is full and stops recirculation. In-between the two specified levels, the operational status for the previous month, (with or without recirculation) continues.

The number of recharge cells used as delivery areas for recirculated springflow in the model was adjusted on a trial and error basis until the computed water level rises were reasonable. A fixed percentage of the recirculated springflow goes to designated recharge cells in the model. For each designated cell, the recirculated springflow is simply added to the natural recharge.

Finally, GWSIM4 computes water level information in the vicinity of the recharge areas, springflow recirculation rates, springflows, water levels, and volumes of springflow recirculation. These results were used to evaluate aquifer performance subject to two conceptual management plans and three springflow recirculation system capacities ranging from 0 to 400 cfs.

### 2.2.2 Surface Water

As outlined in the preceding sections, each of the two management plans was evaluated with a baseline and two levels of springflow recirculation. Because the recirculation would be comprised of Guadalupe River water taken from below Comal and/or San Marcos Springs, this would affect remaining flow in the river. Therefore, for each of the GWSIM4 model simulations of the Edwards Aquifer, two companion analyses were made to evaluate potential effects on: (1) downstream flows, (2) water available for existing water rights, and (3) estimated fisheries harvest in the Guadalupe Estuary.

The Guadalupe - San Antonio River Basin Model (GSA Model) was utilized to evaluate changes in flow immediately below the recirculation diversion and to translate the effects of these changes to downstream locations. In addition, the essential but somewhat delayed, changes in spring discharge resulting from the recirculation were simulated using the GSA Model. The GSA Model simulates streamflows throughout the river basin on a monthly basis utilizing an historical sequence of naturalized flows and making adjustments for diversions, return flows, evaporative losses, aquifer recharge, changes in springflow, etc.<sup>8</sup>

---

<sup>8</sup> HDR Engineering, Inc. "Guadalupe - San Antonio River Basin, Recharge Enhancement Study, Volume II - Technical Report", 1993.

For each of the six GWSIM4 model simulations, changes in monthly spring discharges from known historical amounts for Comal, San Marcos, San Antonio, and San Pedro Springs were used as inputs to the GSA Model. The other external input to the GSA Model was the monthly amount of springflows diverted from the Guadalupe River under each management plan/ recirculation system simulation. These monthly amounts were simulated as exports from the appropriate geographic location. GSA Model outputs include simulated monthly flows and water rights shortages at key locations on the Guadalupe, San Marcos and San Antonio Rivers which would result from the combined effects of recirculation diversions and consequent changes in springflow.

Simulated streamflows at the Saltwater Barrier on the Guadalupe River near Tivoli were then utilized to quantify potential effects on fisheries harvests for the Guadalupe Estuary. Fisheries harvest estimates were computed using equations developed by the Texas Water Development Board and the Texas Parks and Wildlife Department (TPWD). These equations predict the harvest of seven key commercial finfish, and shellfish species based on the sequence of monthly freshwater inflows.<sup>9</sup> Relationships between harvest and freshwater inflows depend not only on the magnitude, but also on their timing of these inflows with respect to the life-cycle of each species. These equations have been included in a post processor program for the GSA Model, (referenced herein as the Guadalupe Estuary Model), which tabulates fisheries harvest, salinity fluctuations, and summary statistics.<sup>10</sup>

## **2.3 Evaluation**

### **2.3.1 Aquifer Performance**

Evaluation of recirculated springflow concepts is based on comparison of GWSIM4 model results with the baseline simulations. Comparisons with historical data are not appropriate because aquifer pumpage is at predetermined uniform annual rates and not historical rates. Additionally, comparisons of results with historical data would include model calibration error which is significantly eliminated by comparisons with the baseline runs.

---

<sup>9</sup> TWDB and TPWD, "Freshwater Inflows to Texas Bays and Estuaries: Ecological Relationships and Methods for Determination of Needs," Joint Estuarine Research Study, 1994.

<sup>10</sup> HDR Engineering, Inc., "Guadalupe-San Antonio River Basin Model Modifications and Enhancements," Trans-Texas Water Program, West Central Study Area, Phase II, San Antonio River Authority, et al., March, 1998.



Evaluation of Edwards Aquifer response to springflow recirculation includes analyses of changes in (1) the overall mass balance of water movement into and out of the aquifer, (2) flow from Comal Springs, (3) flow from the combined Comal and San Marcos Springs after diversion from the Guadalupe River for recirculation, (4) flow from all major springs, (5) water levels in the two recharge areas, and (6) water levels at San Antonio and Uvalde index wells. Finally, GWSIM4 simulation results are reviewed in the context of historical water level and springflow data, hydrogeology, modeling studies, and calibration and test ranges of the model.

### 2.3.2 Streamflow and Fisheries Harvest

Evaluation of the potential effects of springflow recirculation on surface water flows, availability, and fisheries harvest was accomplished by comparing the results of successive simulations using the GSA Model and the Guadalupe Estuary Model simulations. For each management plan (400,000 ac-ft/yr pumpage and “sustained yield” pumpage), comparisons were made between the baseline case with no springflow recirculation and the two cases involving recirculation of up to 200 cfs and 400 cfs, respectively.

Key parameters for comparison were:

- changes in the estimated firm yield of Canyon Reservoir;
- median monthly flows on the Guadalupe River at the H-5 Dam, at Cuero, and at the Saltwater Barrier, the San Antonio River at Falls City, and the San Marcos River at Luling;
- flow frequency curves derived from monthly streamflows for these same five locations;
- water rights shortages for the Guadalupe River at Victoria and the Saltwater Barrier and the San Antonio River near Falls City;
- fisheries harvest estimates for seven species of interest in the Guadalupe Estuary.

(This page intentionally left blank.)

### 3.0 CONCEPTUAL MANAGEMENT PLANS

Two general management plans were evaluated. One sets long-term Edwards Aquifer pumpage at a fixed rate of 400,000 ac-ft/yr. The other sets long-term pumpage from the aquifer at a rate equal to the "sustained yield" which is defined herein as the maximum fixed pumpage rate that does not cause the flow from Comal Springs to fall below 60 cfs during the worst month of the drought of record.

#### 3.1 Pumpage of 400,000 ac-ft/yr

##### 3.1.1 Ground Water

###### 3.1.1.1 Recirculated Springflow

For the recirculation rate of up to 200 cfs, available water is recharged to Salado, Leon, and Helotes Creeks in northwestern Bexar County with a third of the water going to each creek. For the maximum recirculation rate of 400 cfs, the first 200 cfs is recharged in northwestern Bexar County and the remainder is recharged in Verde, Hondo, Parkers, and Seco Creeks in northern Medina County (Figure 2.1-1). The actual rate of recirculated springflow will be dependent upon springflows availability and ground water levels in index wells located in the targeted recharge areas (Figure 2.2-1). In Bexar County, the Hill County well (State Well No. 68-29-103) was used as the index well; and, in Medina County, the Seco Creek well (69-38-601) was used as the index well. If the water level in the index well rises above a given elevation, then the recirculation diversion is turned 'OFF' to that recharge area. Likewise, if the water level declines below a given elevation, then the recirculation diversion is turned 'ON.'

For the recirculation rate of up to 200 cfs, the jagged breaks in the line on (Figure 3.1-1) below 200 cfs reflect conditions when there is insufficient springflows in the stream to provide a maximum diversion rate of 200 cfs. When there is an abrupt change from 200 cfs to 0 cfs and later back to 200 cfs, water levels in the index well in the recharge area have turned the diversion 'OFF' and then back 'ON.' Two important characteristics shown in this graph are the reduced water available for recirculation during the drought of the 1950s and the intermittent periods when the index well indicated that the aquifer in northwestern Bexar County was 'full' and turned

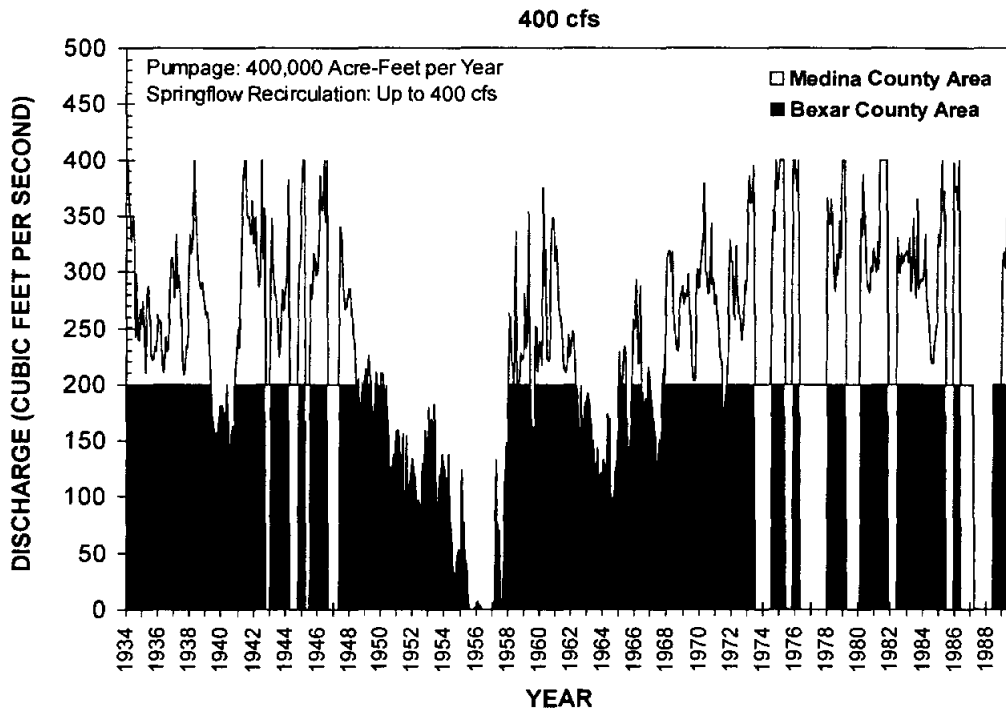
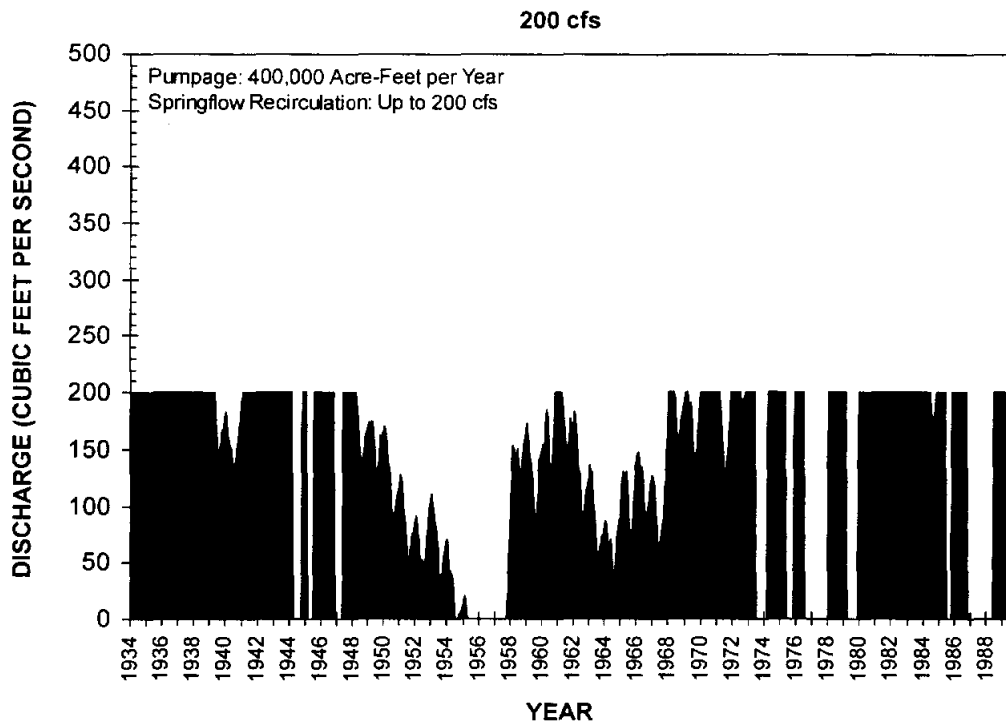

CONCEPTUAL EVALUATION OF  
SPRINGFLOW RECIRCULATION

TRANS TEXAS WATER PROGRAM /  
WEST CENTRAL STUDY AREA



HDR Engineering, Inc.

**RECIRCULATED SPRINGFLOW**  
400,000 ACFT/YR AQUIFER PUMPAGE

FIGURE 3.1-1

the recirculation system 'OFF' (1973 – 1989). Because of these two constraints, the recirculation rate average 136 cfs out of a possible 200 cfs during the 1934-1989 period.

For the maximum recirculation rate of 400 cfs, two recharge areas were utilized as shown in (Figure 2.1-1). The first 200 cfs goes to northwestern Bexar County and the balance goes to Medina County. Again, the jagged breaks in the plot in (Figure 3.1-1) indicate a lack of available water to utilize the maximum diversion rate. The graph shows that the maximum diversion rate is reached about 10 times, but the duration of operation at the maximum rate is always less than a year. The abrupt changes in the plots indicate the frequent turning of the diversions 'OFF' and 'ON.' The only times that recirculation diversions were turned 'OFF' completely occurred in 1987 and 1988. Because of these two constraints, an average of 225 cfs out of a possible 400 cfs maximum rate was diverted during the 1934-1989 period. Of the 225 cfs, a long-term average of 145 cfs was recharged in Bexar County and an average of 80 cfs was recharged in Medina County.

#### 3.1.1.2 Water Budget

The TWDB representation of the Edwards Aquifer with the GWSIM4 ground water flow model, with the modifications by HDR for this study, maintains a water balance considering factors which effect storage including: wells, springs, leakage to adjacent formations, natural recharge, and recirculated recharge.

For the conceptual evaluation in which pumpage remained constant at 400,000 ac-ft/yr and natural recharge was the same for all three simulations, the only changes between the baseline conditions and the two recirculation rates were springflow, leakage, recirculated springflow, and change in storage (Figure 3.1-2). Even though the maximum springflow recirculation rates were 200 and 400 cfs (144,500 and 289,000 ac-ft/yr); water availability and a full aquifer in the recharge area resulted in the average recirculation rates of 136 and 225 cfs (98,375 and 162,777 ac-ft/yr), respectively. On the average, natural recharge amounted to about 642,000 ac-ft/yr. during the 1934-1989 historical period. Thus, recirculated recharge account for respective increases of 15 and 25 percent in overall recharge to the Edwards Aquifer. Because pumpage was held constant, about 80 percent of the recirculated springflow returned to the springs, about 16 percent went into aquifer storage, and 4 percent to leakage near Uvalde.

# WATER BUDGET OF EDWARDS AQUIFER, 1934-1989

Pumpage: 400,000 Acre-Feet per Year

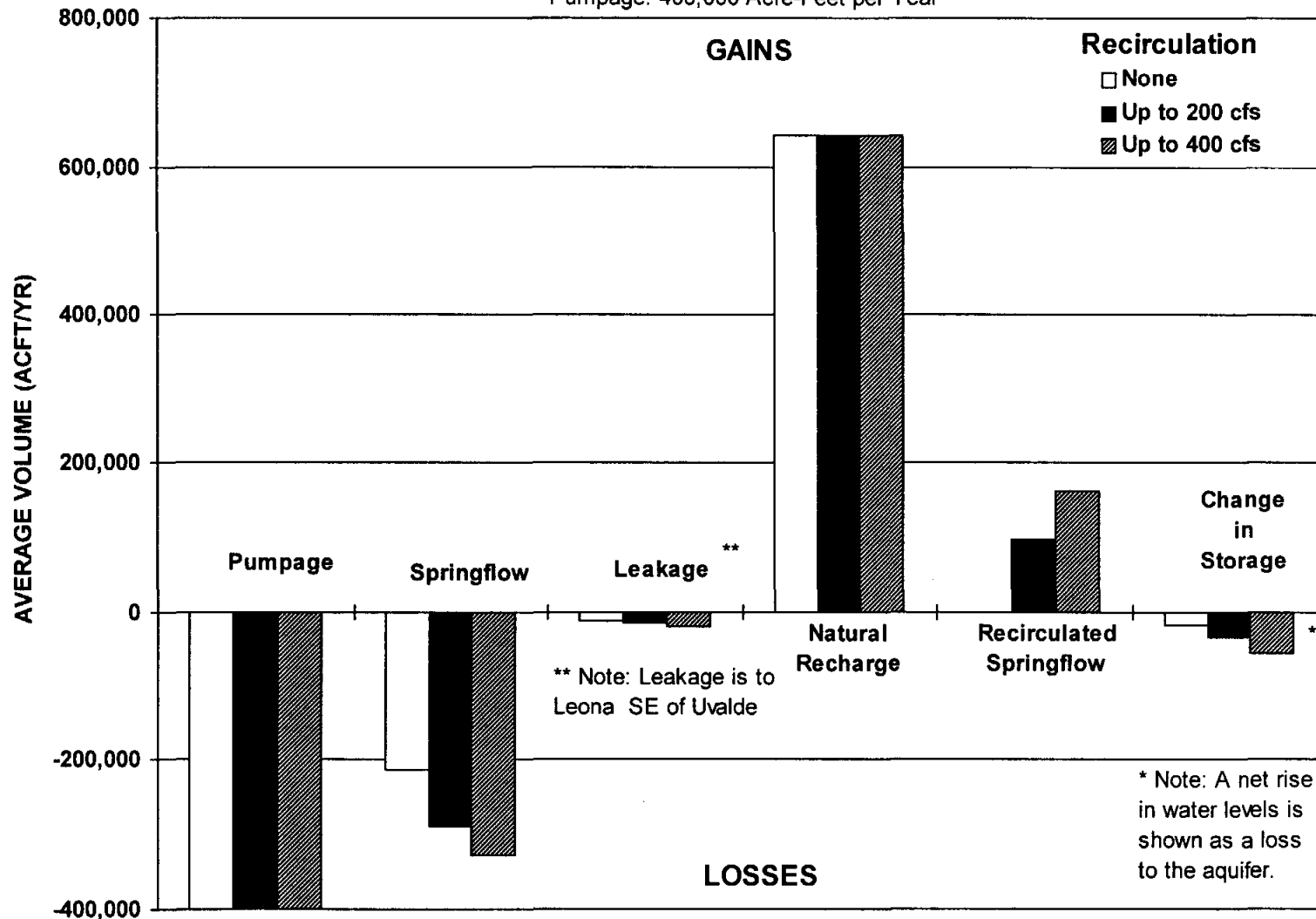

TRANS TEXAS WATER PROGRAM /  
WEST CENTRAL STUDY AREA

**WATER BUDGET**  
400,000 ACFT/YR PUMPAGE

CONCEPTUAL EVALUATION OF  
SPRINGFLOW RECIRCULATION



HDR Engineering, Inc.

FIGURE 3.1-2

However, when the maximum rate was increased to 400 cfs, the percentage of recirculated springflow discharging from all springs was 71 percent; the amount of water going into storage increased to 24 percent; and, the increase in leakage in the Uvalde was 5 percent. These changes are attributed to a portion of the recirculated springflow being recharged northwest of the Medina Lake and Diversion Lake fault complex which causes the water to be temporarily stored behind these faults and to take a very long flowpath before the recharge can influence springflow. The leakage rate in the Uvalde area is believed to approximate the discharge from Leona Springs and represents only a fraction of the overall water budget.

The error in the differences between the losses and gains is less than 1 percent. Some sources of this error include: closure in iterations by the model's solution method, well pumpage that is stopped by the model when calculated water levels fall below the base of the aquifer, and recharge that is stopped by the model when calculated water levels reach the land surface.

#### 3.1.1.3 Comal Springs

Flow from Comal Springs for the baseline conditions with constant pumpage of 400,000 ac-ft/yr and no recirculation for the period from 1934 to 1946 averaged about 200 cfs (Figure 3.1-3). Beginning in 1947, springflows dropped sharply and finally went to zero in 1954 and did not resume until 1957. From 1957 to 1973, flow averaged about 125 cfs which is considerably below the flow of 200 cfs in the first period. The difference could be attributed to below average recharge; however, some of it has to be attributed to refilling depleted storage in the aquifer. The last period is from 1974 to 1989 during which flows averaged about 275 cfs which is considerably above the 200 cfs during the first period. Overall, the flow from Comal Springs from 1934 to 1989 averaged 172 cfs for the management plan with constant pumpage of 400,000 ac-ft/yr and no recirculation.

Flows from Comal Springs for the baseline condition of no recirculation and with recirculation rates of up to 200 and 400 cfs are shown in (Figure 3.1-3). The amount of time when the springs are below 60 cfs and at no flow are of critical interest. For a recirculation rate of up to 200 cfs, the amount of time springflow at Comal is below 60 cfs has been reduced from 9.25 to 2.75 years and at the no flow condition the amount of time changed from 2.75 to 0.5 years. For a recirculation rate of up to 400 cfs, the amount of time below 60 cfs could be

**COMAL SPRINGS**

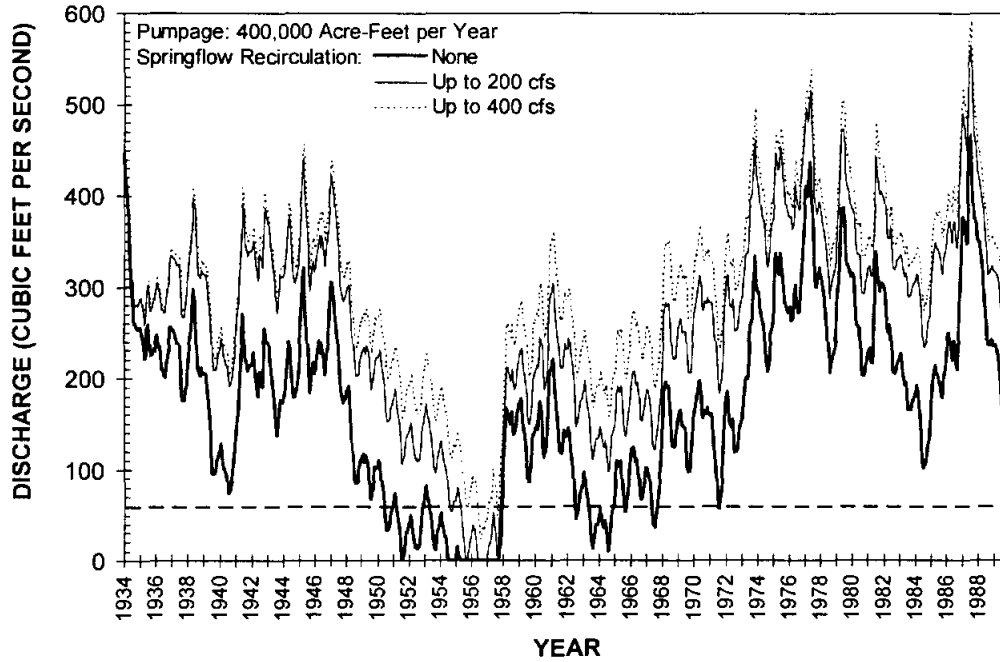

**COMAL SPRINGS - CHANGE IN FLOW**

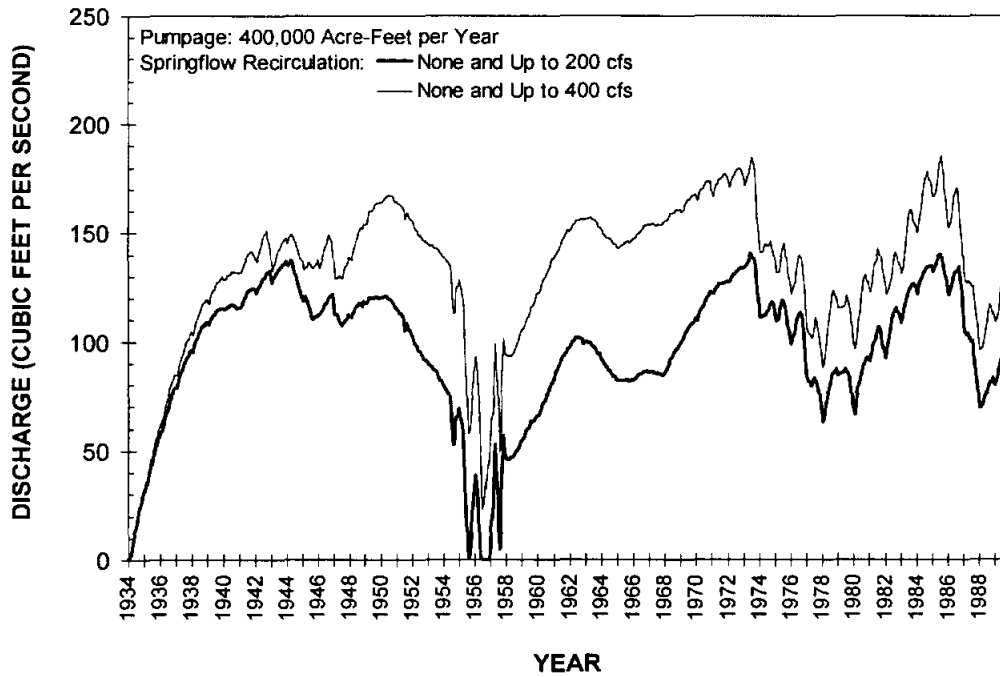

CONCEPTUAL EVALUATION OF  
SPRINGFLOW RECIRCULATION

TRANS TEXAS WATER PROGRAM /  
WEST CENTRAL STUDY AREA



HDR Engineering, Inc.

**COMPUTED FLOW FROM  
COMAL SPRINGS**  
400,000 ACFT/YR PUMPAGE

FIGURE 3.1-3



reduced from 9.25 to 1.0 years. Instead of no flow for extended periods without recirculation, the minimum flow was about 30 cfs. The greatest enhancement in springflows occurred from 1948 to 1973 which coincides with the generally low flows noted during the baseline conditions. The improvement in springflows for the maximum 400 cfs recirculation rate in comparison to the 200 cfs rate is much greater at low flows than high flows.

Another perspective on the impact of springflow recirculation on Comal Springs is related to the delay in occurrence of critical flows caused by drought. For the maximum recirculation rate of 200 cfs, there is a delay of about 5 years; and for the maximum recirculation rate of 400 cfs, the delay is 8 to 9 years. One of the primary reasons for this additional delay is the more westerly location of the targeted recharge area with the 400 cfs rate. This reserve of water in aquifer storage from recirculated springflow greatly reduces the chance of reaching critical flow conditions at Comal Springs during severe drought.

The changes in flow from Comal Springs between the baseline condition and with recirculation rates of 200 and 400 cfs are shown in (Figure 3.1-3). For the 200 cfs recirculation rate, the plots show that it takes at least 10 years for the effects of the recirculated recharge to approach a new flow equilibrium at Comal Springs. For the maximum 400 cfs recirculation rate, this period is estimated to be at least 14 years.

The general trend in increasing springflow from recirculation of water after the drought is interrupted after 1974. This coincides with San Antonio and San Pedro Springs starting to flow and the frequent occurrence of 'OFF' cycles when no springflow is recirculated to northwestern Bexar County because of high groundwater levels.

Overall, Comal Springs discharged an average of about 95 cfs of the 136 cfs (70 percent) average recirculated springflow for the 200 cfs recirculation rate; and, about 131 cfs of the 225 cfs (58 percent) for the 400 cfs recirculation rate.

#### 3.1.1.4 Major Springs

The major springs of the Edwards Aquifer include Comal, San Marcos, San Antonio, San Pedro, and Leona Springs. For the baseline conditions, Comal Springs and San Marcos Springs had average flows of 172 and 121 cfs, respectively. San Antonio, San Pedro, and Leona Springs were dry under the baseline 400,000 ac-ft/yr pumpage and no recirculation. Thus, the total

average flow during baseline conditions was the sum of Comal and San Marcos Springs, that is, 293 cfs. With recirculation, San Antonio and San Pedro Springs flowed intermittently after 1972 with the model results showing Leona Springs remaining dry for all runs. Leakage in the Uvalde area to the Leona Formation is considered to account for Leona Springs. However, this leakage was not added to the total of the five springs identified in the model.

Over half of the total springflow from the Edwards Aquifer comes from Comal Springs. The pattern of flow from all the springs (Figure 3.1-4) is similar to the flow from Comal Springs as shown in (Figure 3.1-3). The impact of the 1950s drought is evident with declines in flow to less than 100 cfs for about 3 years. The hydrographs show rapid recoveries after the drought but are short lived because of declines from a drought in the early 1960s. Beginning in the mid-1960s, springflows recovery was moderate and steady until the early 1970s when recovery was again rapid. Since the early 1970s, flows appear to be substantially above normal, except for short periods in 1984 and 1989.

The change in the combined flow from all the springs (Figure 3.1-4) shows a pattern very similar to Comal Springs. However, San Marcos Springs increased less than 10 cfs at any time because most of the enhancement occurs at Comal Springs which is located between the areas of recharge and San Marcos Springs. In contrast, San Antonio and San Pedro Springs flow during high water level conditions or generally during the winter. This flow causes the flow hydrographs to take on a jagged pattern during the high water conditions in the early 1940s and after 1970. As with Comal Springs, turning the recirculation 'OFF' and 'ON' in northern Bexar County when water levels are high added to the erratic pattern.

Overall, springflow recirculation for rates up to 200 and 400 cfs increased total springflow by 108 and 160 cfs, respectively, for the period from 1973 to 1989. For the same period, San Antonio and San Pedro Springs flowed at an average of 21 and 52 cfs, respectively. This is in contrast to them being dry prior to 1973 and during all years of the baseline simulation.

#### 3.1.1.5 Guadalupe River

The impact of springflow recirculation on the Guadalupe River is presented in two parts. One is for the diversion of up to 200 cfs from Lake Dunlap. The other is for a diversion of up to

**MAJOR SPRINGS**  
COMAL, SAN MARCOS, SAN ANTONIO, AND SAN PEDRO SPRINGS

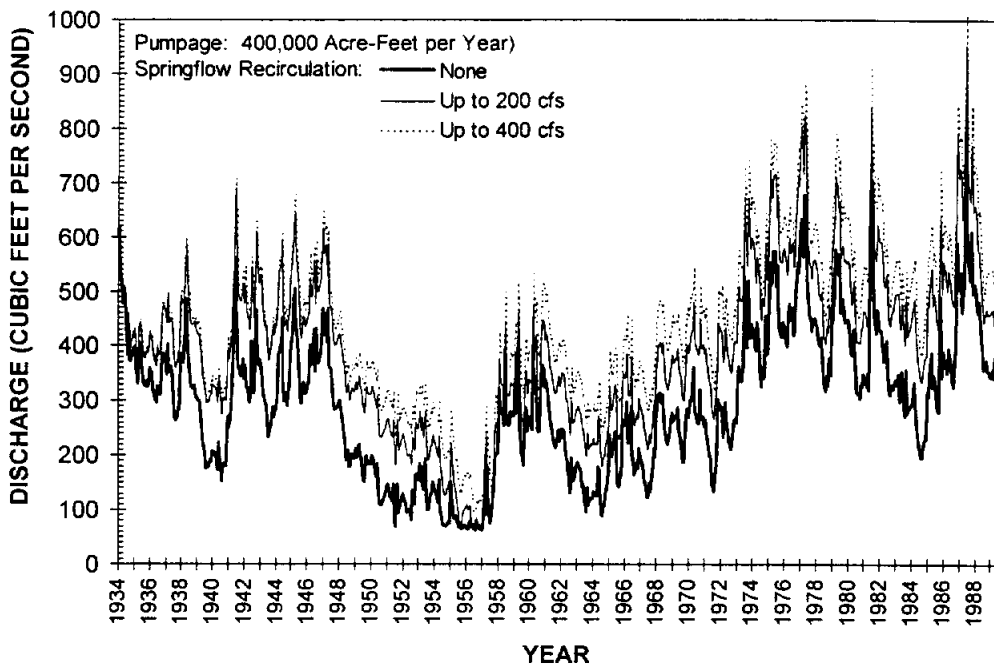

**MAJOR SPRINGS - CHANGE IN FLOW**

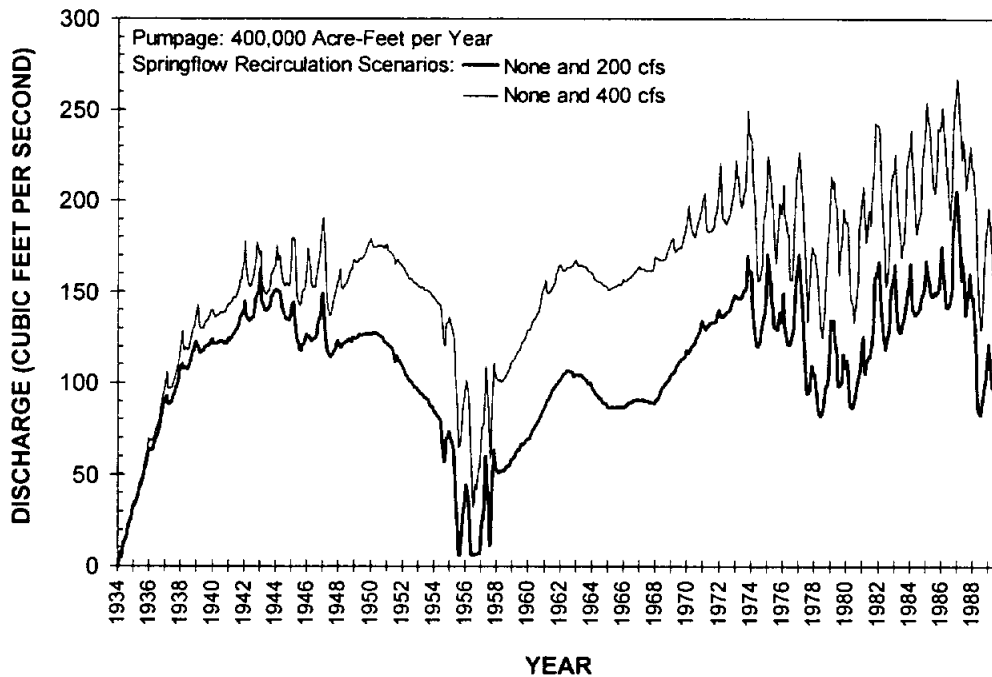

CONCEPTUAL EVALUATION OF  
SPRINGFLOW RECIRCULATION

TRANS TEXAS WATER PROGRAM /  
WEST CENTRAL STUDY AREA



HDR Engineering, Inc.

**COMPUTED FLOW FROM MAJOR  
SPRINGS OF EDWARDS AQUIFER  
400,000 ACFT/YR PUMPAGE**

FIGURE 3.1-4

400 cfs from the Guadalupe River downstream of the mouth of the San Marcos River near Gonzales.

Springflow in the Guadalupe River at Lake Dunlap is taken as equivalent to the flow from Comal Springs which was presented earlier in (Figure 3.1-3). To show the impact of springflow diversions of up to 200 cfs on flows in the Guadalupe River, the diversion rate calculated by the model is subtracted from the discharge of Comal Springs. The change in flow in the Guadalupe River (Figure 3.1-5) reflects both the enhanced springflow from Comal Springs and the diversion for springflow recirculation. As expected, the initial recirculated flow reduction in 1934 is 200 cfs; but, the recharge of the recirculated springflow gradually causes the flow of Comal Springs to increase above baseline rates which in turn reduces the impact on the loss of flow in the Guadalupe River to be significantly less than the 200 cfs starting conditions in 1934. For example, by 1945, the loss was about 60 cfs. The spikes in the change of springflow in the Guadalupe River occurred when the diversion was turned 'OFF' and back 'ON.' Of importance, the graph shows the flows to average about 30 cfs greater during the 1950s drought with recirculation than without recirculation. Recirculation also improved the flow conditions in the Guadalupe River during the low flow conditions of the mid-1960s. However, for the 200 cfs recirculation run, the average flow in the Guadalupe River decreased about 35 cfs.

Diversion of the water with a recirculation rate of up to 400 cfs would be from the Guadalupe River below the mouth of San Marcos River so that the diversion could include both Comal Springs and San Marcos Springs. To show the impact of the maximum 400 cfs springflow diversion on flows in the Guadalupe River; the diversion rate as calculated by the model is subtracted from the combined discharge of Comal Springs and San Marcos Springs. The water available for diversion is limited to the rate that is in excess of 160 cfs. The change in springflow in the Guadalupe River for the 400 cfs recirculation test is shown in (Figure 3.1-5). As shown earlier in the springflow recirculation graph, rarely was 400 cfs available for diversion. As a result, the average diversion rate prior to the drought of the 1950s was about 125 cfs. However, during the drought of the 1950s the flow in the Guadalupe was greater than during the baseline conditions with no recirculation. For this test, the increase in flow during this critical period was more than 50 cfs. Flows in the Guadalupe River during the low flow period that occurred in the mid-1960s also increased. The spike occurring in the mid 1980s is in response to diversions

**GUADALUPE RIVER  
CHANGE IN FLOW AFTER DIVERSION**

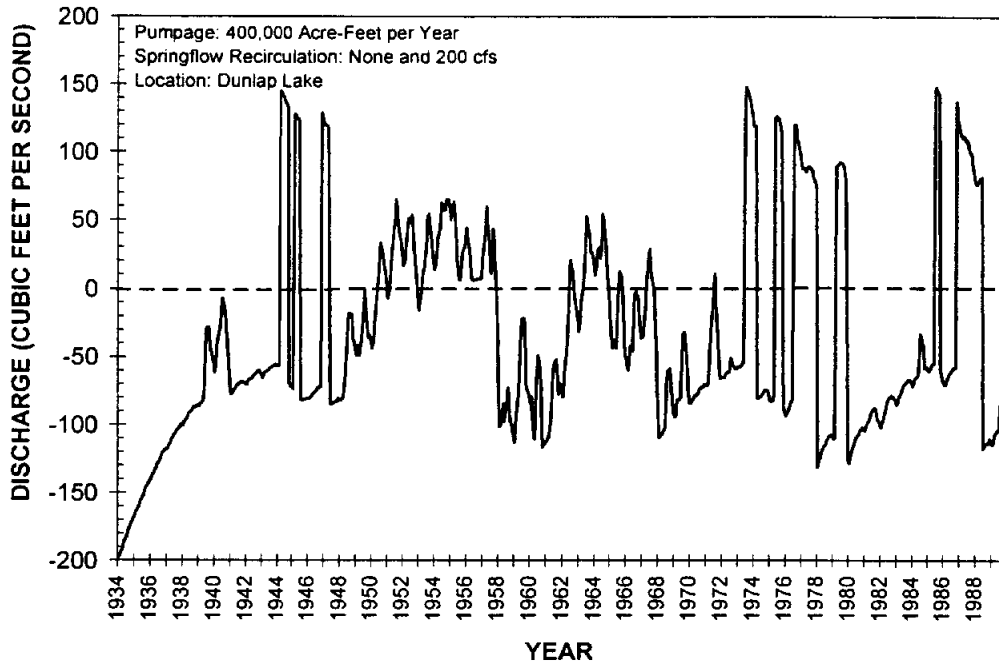

**GUADALUPE RIVER  
CHANGE IN FLOW AFTER DIVERSION**

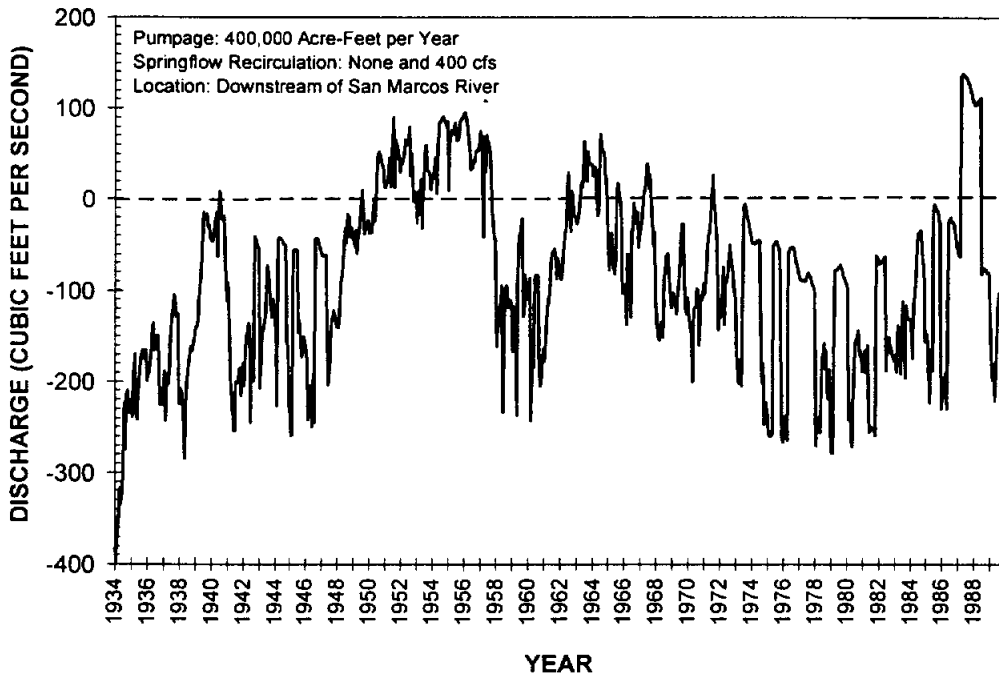

CONCEPTUAL EVALUATION OF  
SPRINGFLOW RECIRCULATION

TRANS TEXAS WATER PROGRAM /  
WEST CENTRAL STUDY AREA



HDR Engineering, Inc.

**COMPUTED CHANGE IN FLOW  
GUADALUPE RIVER AFTER DIVERSION  
400,000 ACFT/YR PUMPAGE**

FIGURE 3.1-5

being turned 'OFF' in both recharge areas. Overall, for the 400 cfs recirculation rate, flows in the Guadalupe River were reduced about 86 cfs.

#### 3.1.1.6 Water Levels

Water levels were analyzed at four locations; two are in the outcrop areas and two in the confined zone. The Hill Country monitoring well is located in the outcrop area in northern Bexar County and was selected to represent the central part of the outcrop as well as the Bexar County recharge area. The Seco Creek monitoring well is located northwest of the Medina Lake Fault and was selected to represent the water level conditions in the outcrop areas in the northwest part of the aquifer and in the Medina County recharge area. The J-17 well represents the San Antonio area and the Uvalde well represents the western part of the aquifer. The later two are in the confined zone and are used as indices for declaring stages of drought management.

For the baseline condition, the calculated water levels in the Hill Country well averaged about 700 ft above mean sea level from 1934 to 1947 then declined until the model's cell went dry at an elevation of 660 in 1955. The model shows water levels recover to an elevation of about 710 ft after 1974 with peak elevations of over 730 ft in 1977 and 1987 (Figure 3.1-6). With springflow recirculation, water levels rose to an operating range of 740 and 745 ft which are the elevations where the recharge was turned 'OFF' and 'ON.' This resulted in water levels being about 30 ft higher than without recirculation and required about 10 years. Because recirculation to the area near the Hill Country well is limited to 200 cfs for both simulations, the water level hydrographs for maximum recirculation rates of 200 cfs and 400 cfs is nearly the same until 1949. Then, from 1949 to 1974, the management plan with a maximum 400 cfs recirculation rate caused the water levels to be about 10 ft higher than the plan having a lower recirculation rate. This is caused by more springflow being available for recirculation which, in turn, allows the amount of recirculation to be greater during times of drought. After 1974, the water levels for the two recirculation rates were again very similar and centered along the operating range of 740 to 745 ft.

The calculated water levels at the Seco Creek well location for baseline conditions reflects a general decline of about 150 ft from 1934 to the worst part of the drought in 1957 and overall recovery of about 100 ft by the 1980s (Figure 3.1-6). For a recirculation rate of up to 200 cfs,

### HILL COUNTRY WELL

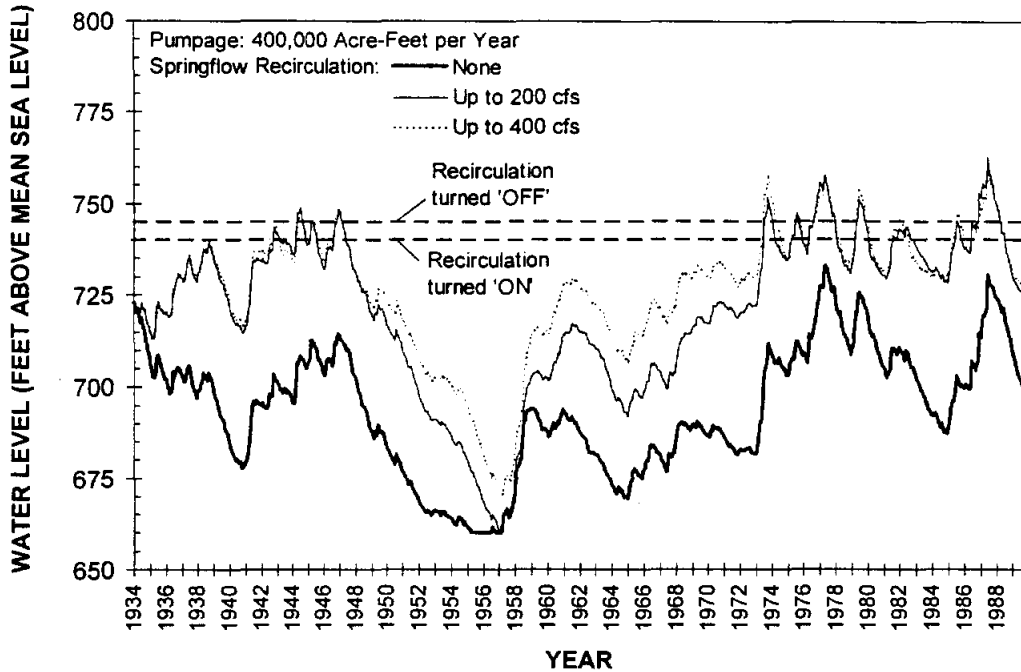

### SECO CREEK WELL

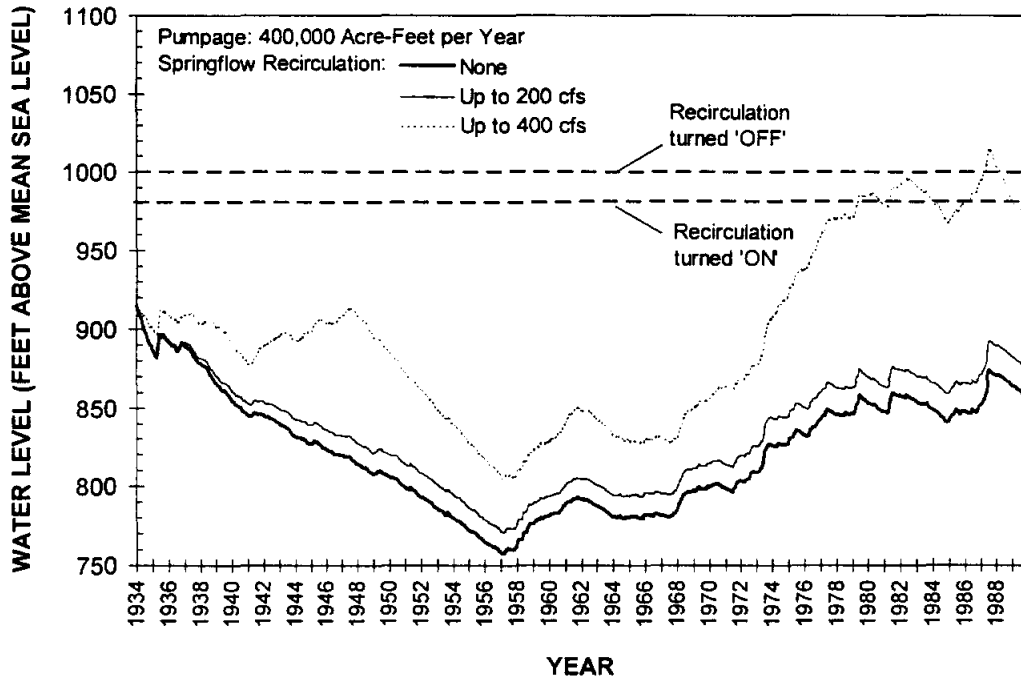

CONCEPTUAL EVALUATION OF  
 SPRINGFLOW RECIRCULATION

TRANS TEXAS WATER PROGRAM /  
 WEST CENTRAL STUDY AREA



HDR Engineering, Inc.

COMPUTED WATER LEVELS  
 AT INDEX WELLS  
 400,000 ACFT/YR PUMPAGE

FIGURE 3.1-6

none of the recharge is occurring in Medina County. As a result, the water levels show only a rise of about 15 ft above the baseline water levels. This rise is in response to the higher water levels in Bexar County that is caused by the recharge of springflow. However, for the recirculation rate of up to 400 cfs, there is recharge in the Medina County area. This recharge is greatest in the 1940s and after 1972. This is reflected in about a 90 ft rise by 1947 and about 120 ft after 1972. The decline in water levels in 1987 is caused by turning the recirculation 'OFF.' It was turned back 'ON' in 1989; but, the simulation ended before a rise in water levels at the index well occurred.

The calculated water levels at the J-17 monitoring well for baseline conditions reflect the typical regional trend in ground water conditions with normal water levels from 1934 to 1947, steady declines to about 600 ft by 1957, irregular recoveries until 1974 and generally higher than normal water levels after 1974 (Figure 3.1-7). Within the regional trends, there are annual pumping cycles where the summer pumping causes the water levels to decline about 20 ft from the winter recoveries. As with the Hill Country well, the two recirculation tests produced similar rises in water levels above the baseline conditions until 1947. Overall, water levels for the 200 cfs recirculation rate increased water levels an average of about 17.2 ft while the 400 cfs rate increased water levels an average of about 23.7 ft. The erratic water levels after 1974 are caused by seasonal flow from nearby San Antonio and San Pedro Springs and the intermittent operation of the recirculation system.

Proposed drought management rules for the San Antonio area would impose pumpage reductions based on water levels in the J-17 well in the following stages: Stage I, 642-650 ft; Stage II, 636-642 ft; Stage III, 632-636 ft; Stage IV, 628-632; and Stage V, below 628. For baseline conditions, during 42.6 years of the 56-year test period there would be some stage of drought management. In contrast, for a maximum recirculation rate of 200 and 400 cfs, some level of drought management would be necessary for 17.8 and 9.0 years, respectively. For the most severe stage, the water use controls would last about 13.4 years with no recirculation, 3.2 years with 200 cfs recirculation rate and 1.2 years with 400 cfs of recirculation.

The calculated water levels at the Uvalde monitoring well reflect the regional water level pattern with water levels at an elevation of about 835 ft at the start of the test period, declining to about 760 ft during the worst part of the drought, and recovering to about 820 ft at the end of the



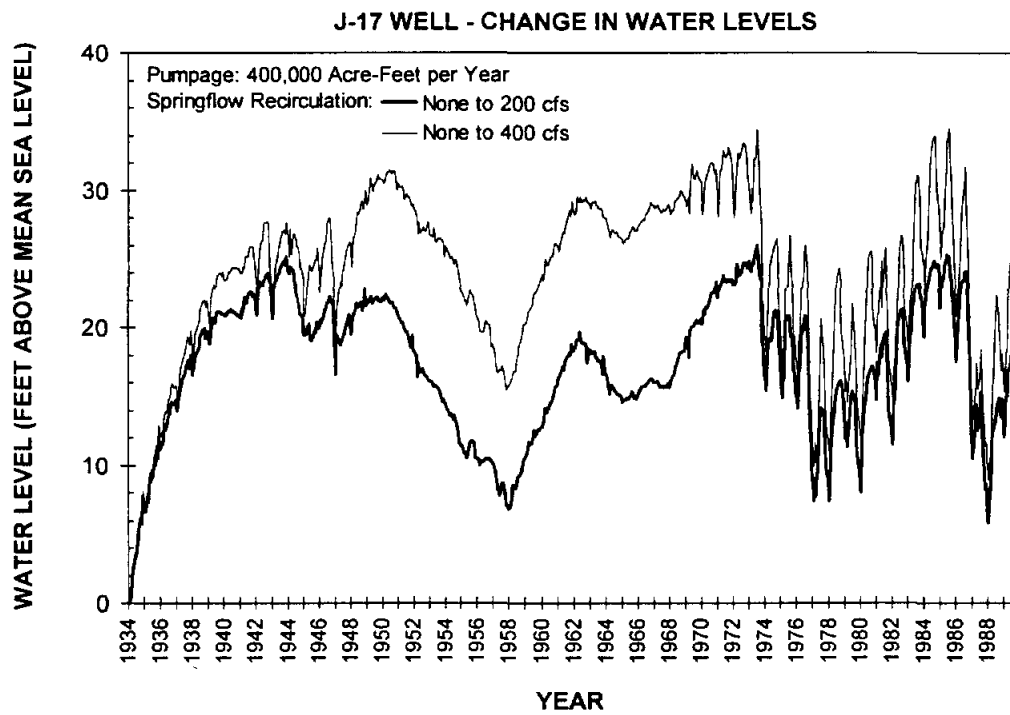
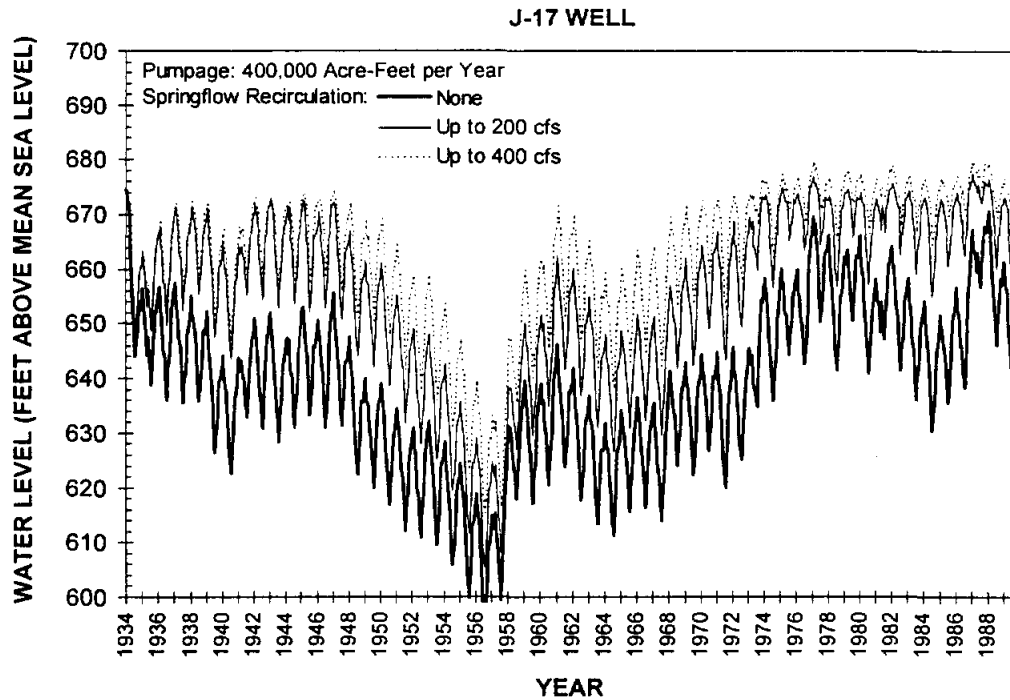

CONCEPTUAL EVALUATION OF  
 SPRINGFLOW RECIRCULATION

TRANS TEXAS WATER PROGRAM /  
 WEST CENTRAL STUDY AREA



HDR Engineering, Inc.

COMPUTED WATER LEVELS  
 AT J-17 INDEX WELL  
 400,000 ACFT/YR PUMPAGE

FIGURE 3.1-7

period (Figure 3.1-8). Like J-17, there was an annual cycle in the water level pattern. Here, the range between summer and winter is about 30 ft which appeared to be caused by local and regional pumping. For the recirculation rate of up to 200 cfs, the water levels gradually increased above baseline conditions until they were about 15 ft higher at the end of 1950. For the rest of the period, water levels were 10-20 ft higher than baseline conditions. For the recirculation rate of up to 400 cfs the water levels had a general rise except during the drought until they were about 45 ft higher than baseline conditions. This peak occurred in about 1986. The higher water level for the 400 cfs recirculation rate is attributed to recharge of recirculated springflow in Medina County. Much of the recharge is deflected by the Medina Lake Fault and the Diversion Lake Fault to the eastern part of Uvalde County before turning toward San Antonio. Proposed drought management rules would impose a Stage I reduction in pumpage in Uvalde County at water levels between 840 and 845 ft and a Stage II reduction when water levels are below 840 ft. The reduction in the amount of time under the stages of conservation can not be reasonably estimated because the model is not sufficiently calibrated in this area of the aquifer for this purpose. This is evident because the simulated water levels are more than 50 ft below measured water levels during the 1980s; but, they are reasonably close during the 1950s drought. However, the model's calculation of water levels rise of about 20 and 45 ft for recirculation of 200 cfs and 400 cfs, respectively, by 1980 are believed to be reasonable. These higher water level conditions would substantially reduce or, possibly, eliminate having to impose water use controls in this area.

### 3.1.2 Surface Water

#### 3.1.2.1 Streamflows and Water Rights Availability

Simulated median monthly streamflows for the 400,000 ac-ft/yr Edwards Aquifer pumpage management plan are shown in (Figure 3.1-9) for several key locations in the Guadalupe - San Antonio River Basin. For comparative purposes, the results of the two recirculation rates are shown along with the baseline case with no recirculation.

For the Guadalupe River at the H-5 Dam near Gonzales, the diversion of up to 200 cfs at Lake Dunlap led to the evident decreases in median monthly streamflow by a range of between

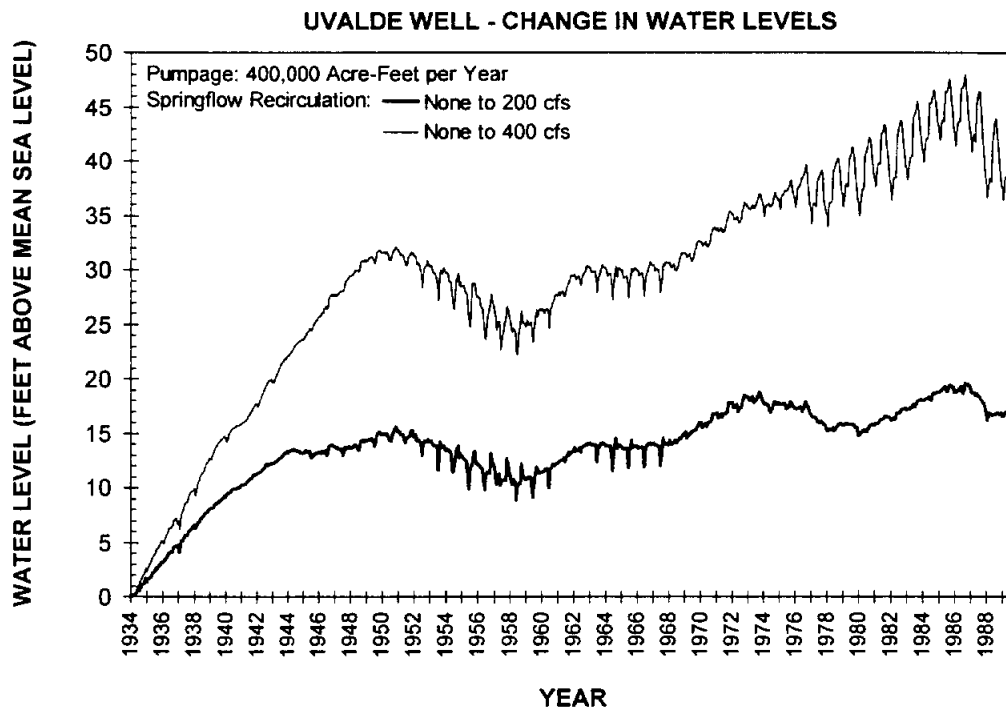
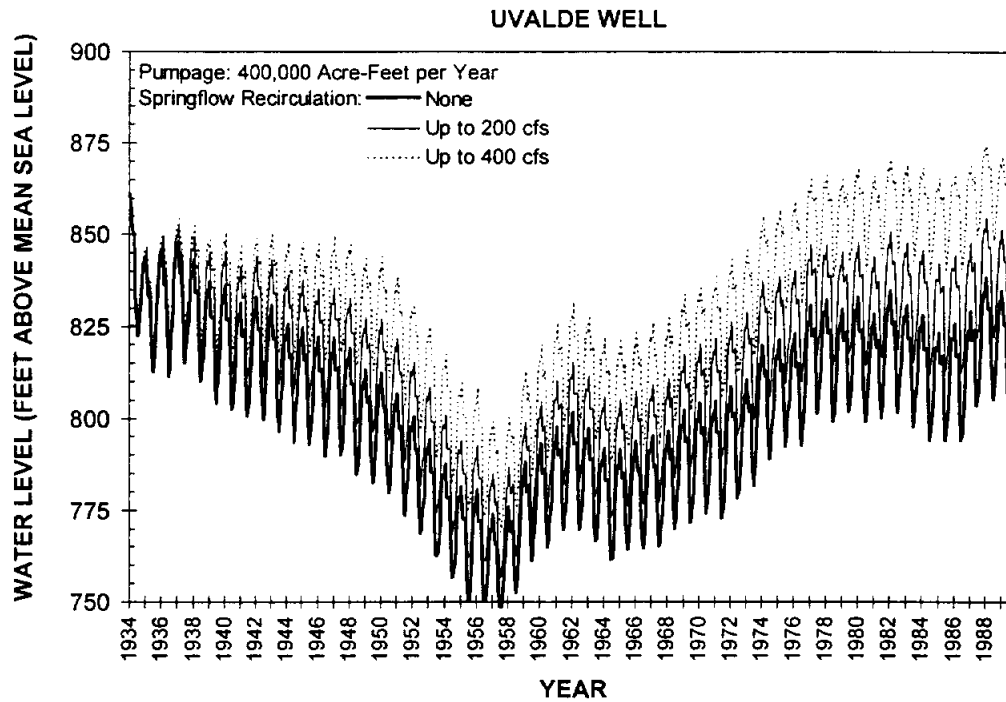

CONCEPTUAL EVALUATION OF  
 SPRINGFLOW RECIRCULATION

TRANS TEXAS WATER PROGRAM /  
 WEST CENTRAL STUDY AREA



HDR Engineering, Inc.

COMPUTED WATER LEVELS  
 AT UVALDE INDEX WELL  
 400,000 ACFT/YR PUMPAGE

FIGURE 3.1-8

**GUADALUPE RIVER AT H-5 DAM**

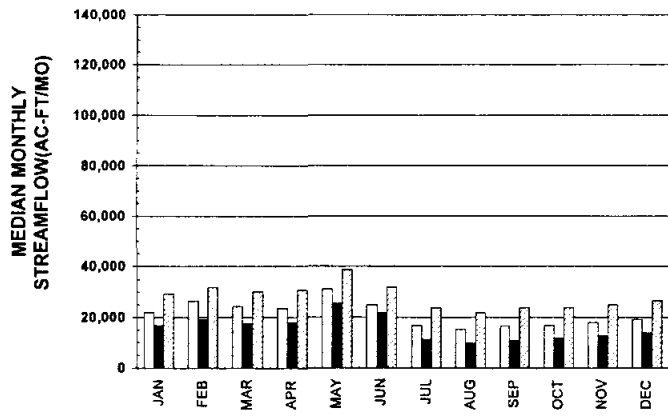

**GUADALUPE RIVER AT CUERO**

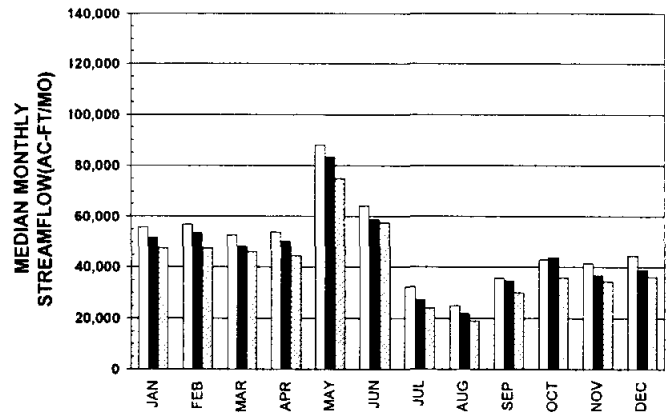

**GUADALUPE RIVER AT SALT WATER BARRIER**

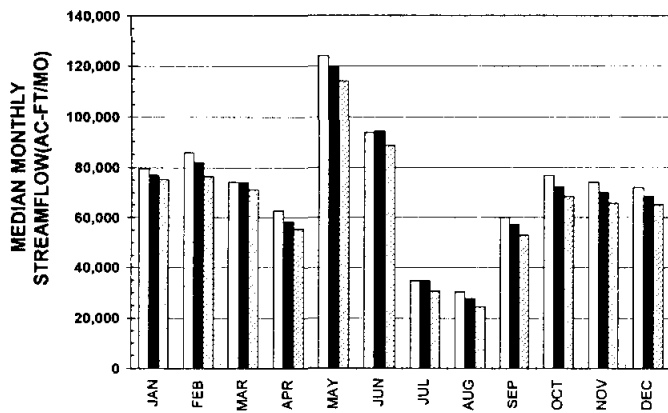

**SAN ANTONIO RIVER AT FALLS CITY**

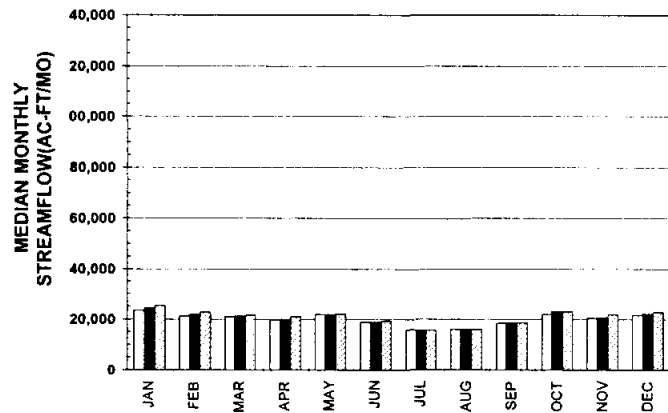

**SAN MARCOS RIVER AT LULING**

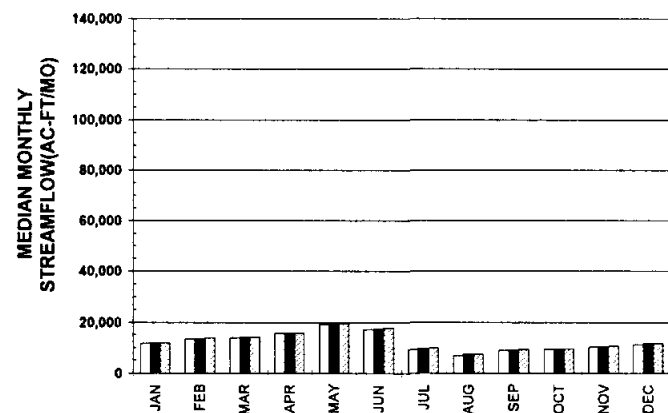

Aquifer Pumpage = 400,000 ac-ft/yr

- Baseline: No recirculation
- Recirculation up to 200 cfs
- ▨ Recirculation up to 400 cfs

CONCEPTUAL EVALUATION OF  
SPRINGFLOW RECIRCULATION



HDR Engineering, Inc.

TRANS TEXAS WATER PROGRAM /  
WEST CENTRAL STUDY AREA

**MEDIAN MONTHLY STREAMFLOWS  
GUADALUPE - SAN ANTONIO  
RIVER BASIN**

400,000 ACFT/YR PUMPAGE

FIGURE 3.1-9

5,000 - 8,000 ac-ft/mo. For the 400 cfs recirculation rate, the recirculation withdrawal was simulated downstream of the H-5 Dam so that the increases in Comal Springs discharges as shown in (Figure 3.1-3) were evident as higher streamflows. Compared to the baseline case, the 400 cfs recirculation test showed increases in median monthly streamflows ranging from approximately 5,000 - 9,000 ac-ft/mo at this location.

For the other two locations on the Guadalupe River, at Cuero and at the Saltwater Barrier near Tivoli, the median monthly streamflow pattern showed decreases for nearly all months under both recirculation rates because the diversion locations were both upstream of these points. At the Cuero location, the 200 cfs recirculation resulted in changes in median monthly streamflows ranging from about -6,000 ac-ft/mo to +1,000 ac-ft/mo (October) as compared to the baseline. The 400 cfs recirculation test resulted in reductions in streamflows at Cuero ranging from 5,000 to 13,000 ac-ft/mo compared to the baseline case.

For the two other locations, the San Antonio River near Falls City and the San Marcos River near Luling the flows in the river showed a small increase as the recirculation rate was increased. These two locations benefit from the increased springflows of San Antonio, San Pedro, and San Marcos Springs (Figure 3.1-4).

Figure 3.1-10 shows monthly flow frequency plots for these same locations under the three variations of the 400,000 ac-ft/yr Edwards Aquifer pumpage management plan. For example, at Cuero streamflow is predicted to be less than or equal to about 27,000 ac-ft/mo 30 percent of the time under the baseline of no recirculation. At recirculation rates of up to 200 cfs and 400 cfs this flow would drop to approximately 22,000 and 19,000 ac-ft/mo, respectively. The Falls City and Luling locations show increases in percentile flows as recirculation is increased because of the greater springflows which influence these locations (San Antonio, San Pedro, and San Marcos Springs).

A summary of the effects of the recirculation of springflows on existing water rights is portrayed in Table 3.1-1. The recirculation has little effect on water rights. For example, at the Saltwater Barrier under the baseline case of 400,000 ac-ft/yr pumpage from the Edwards Aquifer and no recirculation, a predicted average shortage of 7,326 ac-ft/yr (out of a total 220,433 ac-ft/yr of rights) over the entire 56 year period would occur. This shortage would increase to only

GUADALUPE RIVER AT H-5 DAM

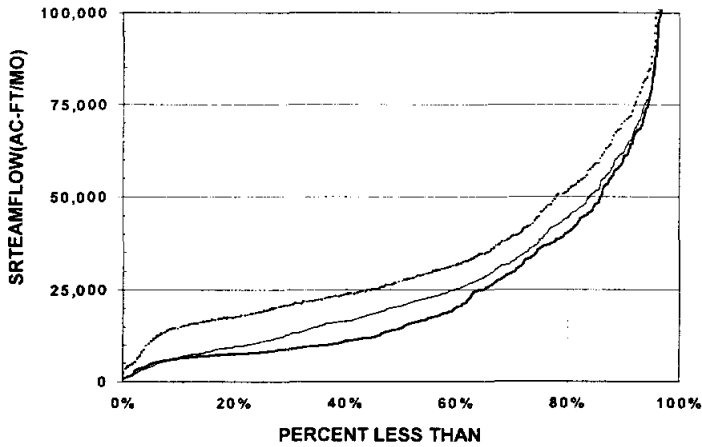

GUADALUPE RIVER AT CUERO

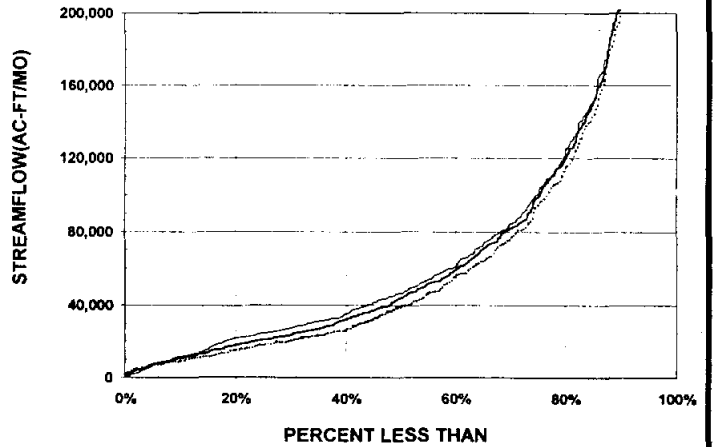

GUADALUPE RIVER AT SALT WATER BARRIER

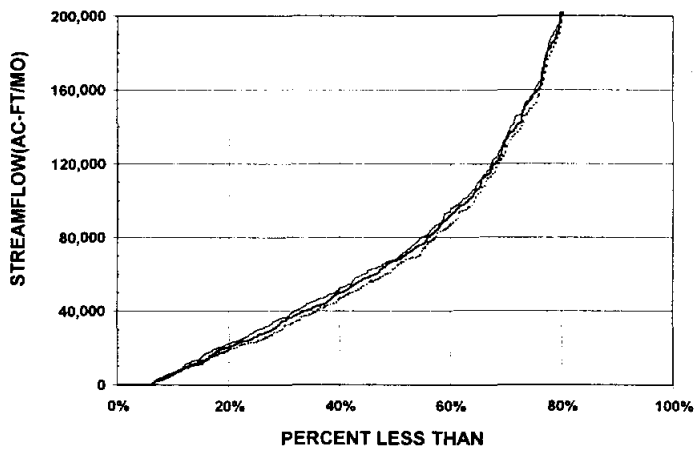

SAN ANTONIO RIVER AT FALLS CITY

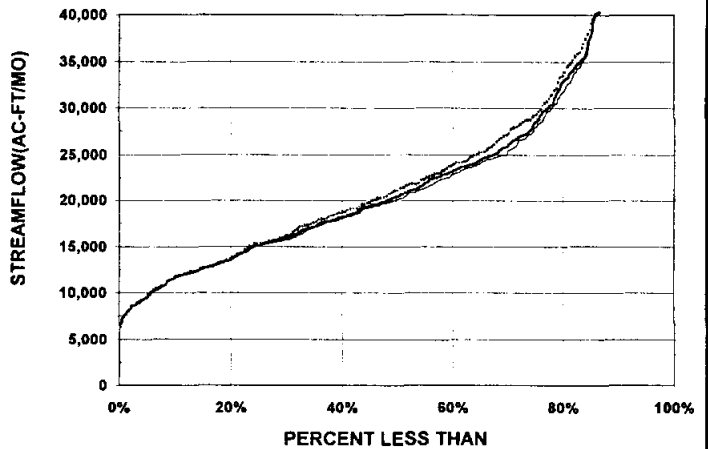

SAN MARCOS RIVER AT LULING

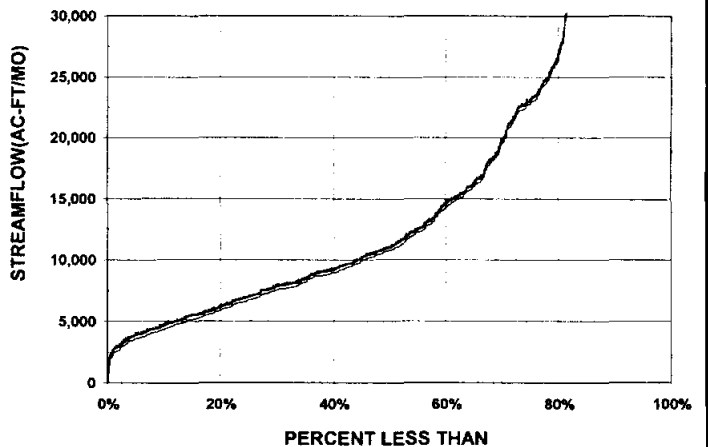

Aquifer Pumpage = 400,000 ac-ft/yr

— Baseline: No recirculation

— Recirculation up to 200 cfs

••• Recirculation up to 400 cfs

CONCEPTUAL EVALUATION OF  
SPRINGFLOW RECIRCULATION



HDR Engineering, Inc.

TRANS TEXAS WATER PROGRAM /  
WEST CENTRAL STUDY AREA

FLOW FREQUENCY CURVES  
GUADALUPE - SAN ANTONIO  
RIVER BASIN

400,000 ACFT/YR PUMPAGE

FIGURE 3.1-10

7,345 ac-ft/yr under the recirculation of up to 200 cfs of Guadalupe River waters for recharge and to only 8,081 ac-ft/yr for the 400 cfs recirculation.

<b>Table 3.1-1.</b>						
<b>Summary of Water Rights Shortages and Canyon Reservoir Firm Yield for 400,000 ac-ft/yr Pumpage</b>						
Location	Total Water Rights (ac-ft)	Shortage or Yield in ac-ft/yr				
		Baseline no Recirculation	Up to 200 cfs Recirculation	Δ	Up to 400 cfs Recirculation	Δ
<b>Long-Term (1934-89) Average</b>						
Guadalupe Riv., Victoria	23,806	0	0	0	0	0
Guadalupe Riv., Saltwater Barrier	220,433	7,326	7,345	19	8,081	755
San Antonio Riv., Falls City	9,311	0	0	0	0	0
<b>Drought (1947-56) Average</b>						
Guadalupe Riv., Victoria	23,806	0	0	0	0	0
Guadalupe Riv., Saltwater Barrier	220,433	25,458	24,440	-1,019	24,037	-1,422
San Antonio Riv., Falls City	9,311	0	0	0	0	0
Canyon Lake firm yield		86,274	86,456	182	86,262	-12

The bottom portion of Table 3.1-1 portrays the simulated water rights shortages for the 1947-56 critical drought period. Under the 400,000 ac-ft/yr Edwards Aquifer pumpage management plan, recirculation would enhance the availability of water to satisfy downstream rights. For example, compared to the baseline, a recirculation of 200 cfs would decrease simulated shortages by 1,019 ac-ft/yr during the critical drought. This is consistent with the findings of Section 3.1.1 regarding increased springflows and shorter periods of critical deficits, especially at Comal Springs. Also shown in the low portion of Table 3.1-1 are the negligible effects of the recirculation on Canyon Lake firm yield.

### 3.1.2.2 Guadalupe Estuary Fisheries Harvest

Table 3.1-2 summarizes the simulated effects of the recirculation of Edward Aquifer springflow on the fisheries harvest of the Guadalupe Estuary. The long-term average harvest of four species could increase slightly while that of three species could decrease slightly. A more detailed statistical presentation of the results of the Guadalupe Estuary Model used to determine these averages is presented in Appendix A.

**Table 3.1-2.  
Summary of Fisheries Harvest Estimates for the  
Guadalupe Estuary for 400,000 ac-ft/yr Pumpage**

Species (klbs/yr)	Baseline no Recirculation	Up to 200 cfs Recirculation	$\Delta$	Up to 400 cfs Recirculation	$\Delta$
White Shrimp	819	822	+3.0	820	+1.0
Brown Shrimp	396	394	-2.0	391	-5.0
Blue Crab	211	209	-2.0	208	-3.0
Eastern Oyster	478	477	-1.0	456	-22.0
Black Drum	26	25	-1.0	25	-1.0
Red Drum	73	72	-1.0	72	-1.0
Seatrout	57	57	+0.0	58	+1.0



## 3.2 "Sustained Yield" Pumpage

The second management plan sets annual pumpage at a "sustained yield" rate so that minimum monthly flows at Comal Springs are not less than 60 cfs. The "sustained yield" is determined by adjusting the annual pumpage in the model on a trial and error basis until the model calculates flows at Comal Springs during the worst month of the drought to be 60 cfs. For the baseline conditions, model runs indicate the aquifer has a "sustained yield" pumpage of 270,000 ac-ft/yr. With springflow recirculation at rates of up to 200 cfs and 400 cfs, the "sustained yield" is 357,000 and 388,000 ac-ft/yr, respectively.

### 3.2.1 Ground Water

#### 3.2.1.1 Recirculated Springflow

Under this management plan and for purposes of this evaluation, all of the recirculated water for the rate of up to 200 cfs is recharged in Salado, Leon, and Helotes Creeks in Bexar County with each one receiving about a third of the water. When the maximum recirculation rate is 400 cfs, the first 200 cfs goes to the same Bexar County area with the remaining 200 cfs (or less) recharged in Seco, Parkers, Hondo, and Verde Creeks in Medina County. The actual rate of recirculated springflow (Figure 3.2-1) is dependent upon the availability of water downstream from the springs and ground water levels in an index well in the recharge area. If less water is available than the maximum recirculation rate, only the amount that is available is diverted to the recharge area. If the water level in the index well for a given recharge area rises above a specified elevation, then the diversion to that recharge area is turned 'OFF.' Later, if the water level declines below another specified elevation, then the diversion is turned back 'ON.'

For the recirculation rate of up to 200 cfs, the jagged breaks in the line below 200 cfs reflect conditions when there is not enough water in the Guadalupe River to provide a maximum diversion rate of 200 cfs. When there is an abrupt change from 200 cfs to 0 cfs and later back to 200 cfs, the water levels in the Hill Country index well in the Bexar County recharge area turned the diversion 'OFF' and then back 'ON.' Important characteristics of the graph are: (1) During the drought of the 1950s, there is a lack of water available for any springflow recirculation and

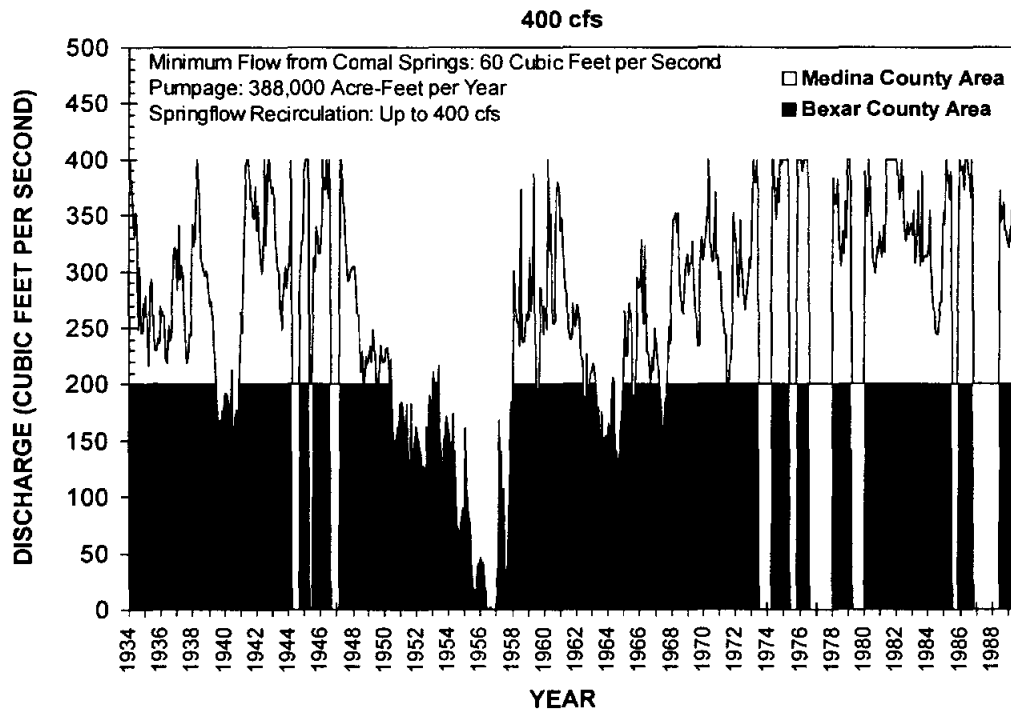
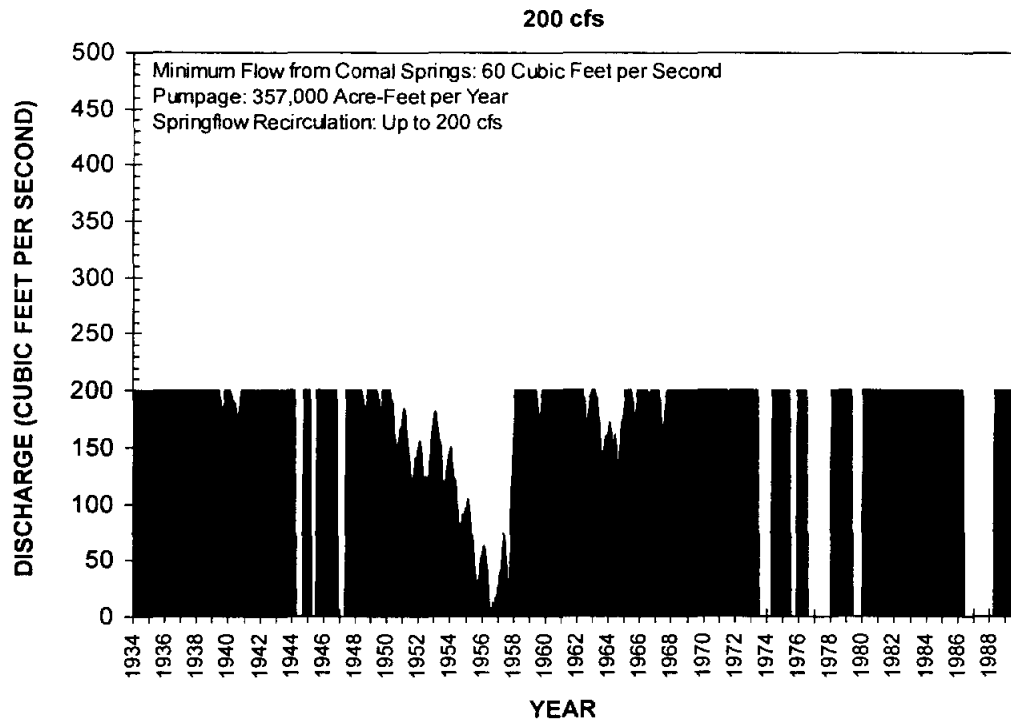

CONCEPTUAL EVALUATION OF  
 SPRINGFLOW RECIRCULATION

TRANS TEXAS WATER PROGRAM /  
 WEST CENTRAL STUDY AREA



HDR Engineering, Inc.

**RECIRCULATED SPRINGFLOW**  
 "SUSTAINED YIELD" PUMPAGE

FIGURE 3.2-1

(2) after 1973, the index well indicates that the aquifer was 'full' on several occasions. Because of these two constraints, an average of 161 cfs out of a possible 200 cfs was diverted for this run.

For the recirculation rate of up to 400 cfs, the jagged breaks in the plot again indicate a lack of water availability to meet the maximum diversion demand of 400 cfs. The graph shows that the maximum diversion rate is reached numerous times but the duration is always less than a year. The abrupt changes in the plots indicates the turning of the diversions 'OFF' and 'ON.' The diversions were turned 'OFF' in the Bexar County recharge area nine times but were not turn 'OFF' in the Medina County area. Because of these two constraints, an average of 257 cfs out of a possible 400 cfs was diverted. Of the 257 cfs, 160 cfs was recharged in Bexar County and 97 cfs was recharged in Medina County.

#### 3.2.1.2 Water Budget

As discussed earlier, the TWDB's representation of the Edwards Aquifer with the GWSIM4 ground water flow model maintains a water balance considering wells, springs, leakage to adjacent formations, and storage and for gains from natural recharge, recirculated recharge, and storage.

Changes between the baseline conditions and the two recirculation runs occurred in pumpage, springflow, leakage, recirculated springflow and change in storage (Figure 3.2-2). The "sustained yields" were calculated to be 270,000, 357,000, and 388,000 ac-ft/yr for no recirculation up to 200 cfs of recirculation (144,500 ac-ft/yr) and up to 400 cfs (maximum of 289,000 ac-ft/yr), respectively. On the average, natural recharge amounted to 642,000 ac-ft/yr. Recirculated recharge resulted in an increase of 18 and 29 percent in recharge to the Edwards Aquifer, respectively. For a recirculation rate of up to 200 cfs, about 75 percent of the recirculated springflow was pumped by wells and about 24 percent flowed from springs. When the maximum rate was increased to 400 cfs, the recirculated springflow being discharged by wells was 63 percent and the amount flowing from springs was 21 percent with most of the remainder going to increases in aquifer storage. In the first case, about 1 percent went into aquifer storage; however, in the second case, about 14 percent went into aquifer storage. These differences are attributed to a significant portion of the recirculated springflow under the 400 cfs scenario being recharged northwest of the Medina Lake and Diversion Lake fault complex. This

# WATER BALANCE OF THE EDWARDS AQUIFER, 1934-1989

Pumpage: Sustained Yield (270,000,  
357,000, and 388,000 Acre-Feet per Year)

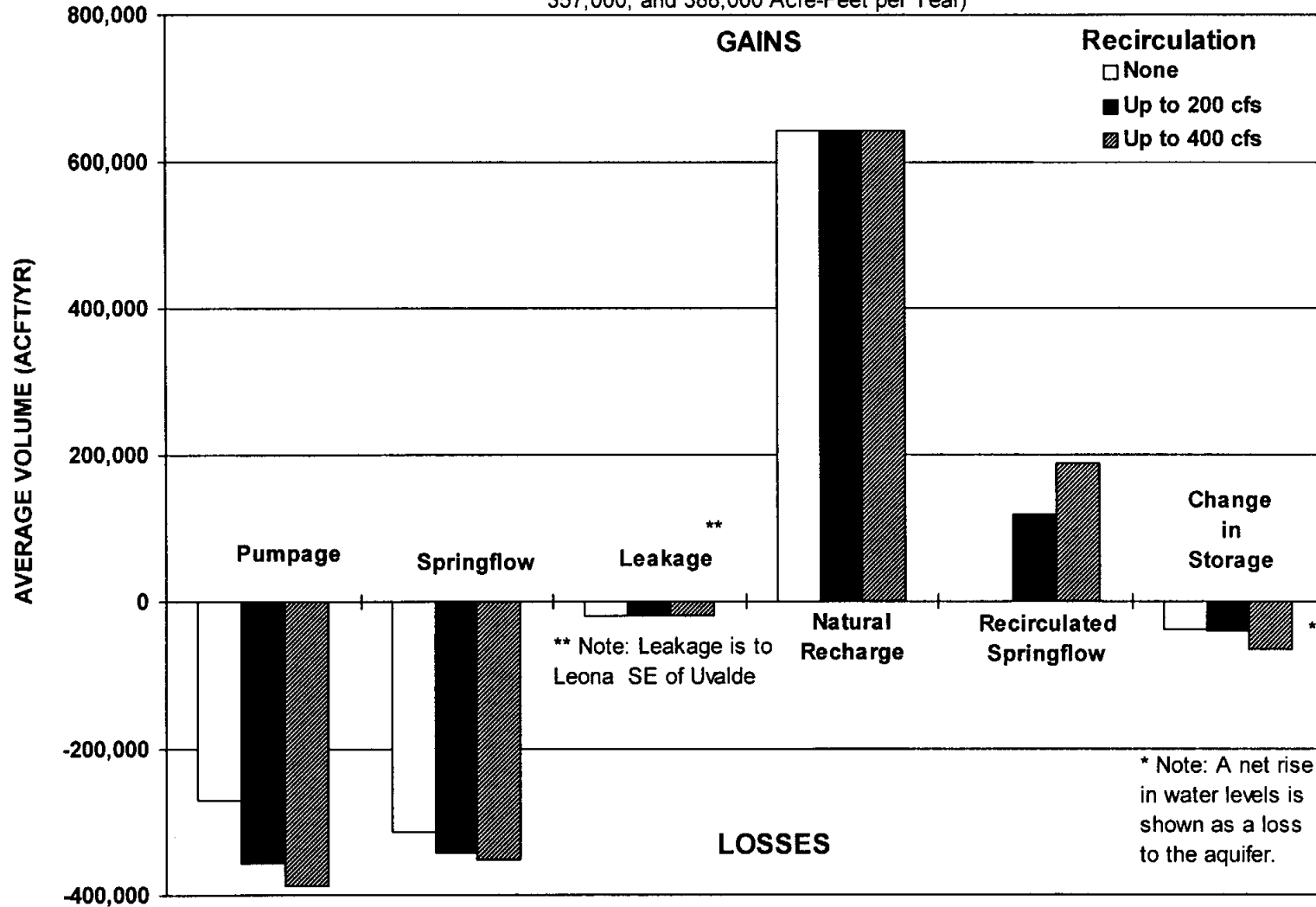

TRANS TEXAS WATER PROGRAM /  
WEST CENTRAL STUDY AREA

**WATER BUDGET**  
"SUSTAINED YIELD" PUMPAGE

CONCEPTUAL EVALUATION OF  
SPRINGFLOW RECIRCULATION



HDR Engineering, Inc.

FIGURE 3.2-2

causes water to be stored for a short time behind these faults and to take a very long flowpath before the water can cause a sufficient rise in water levels to influence springflow. The leakage rate in the Uvalde area into the Leona Formation ranges from about 18,000 to 20,000 ac-ft/yr for the three simulations. This water loss is believed to approximate discharges from Leona Springs.

#### 3.2.1.3 Comal Springs

Based on modeling results for the baseline condition of 270,000 ac-ft/yr Edwards Aquifer pumpage, the flow from Comal Springs from 1934 to 1989 averaged 287 cfs (Figure 3.2-3). With pumpage increased to 357,000 and 388,000 ac-ft/yr and associated recirculation rates of up to 200 and 400 cfs, the calculated flows from Comal Springs averaged 320 and 325 cfs. Under the “sustained yield” baseline pumping with no springflow recirculation test, the discharge from 1934 to 1946 is about 340 cfs. During the high flow conditions during 1973 to 1989, flows were often over 400 cfs and over 600 cfs once. During the 1950s drought, flows did not decline below the critical 60 cfs.

A comparison of the flow from Comal Springs between the baseline condition of no recirculation and recirculation rates of up to 200 and 400 cfs is shown in (Figure 3.2-3). Significant increases (enhancements) in springflow occurred from 1940-1955, 1962-1974 when the flows were about 50 cfs above the baseline conditions. The increase in springflow with the two recirculation scenarios during the 56-year test period was always within 20 cfs of each other. Neither was consistently greater than the other.

#### 3.2.1.4 Major Springs

Flow from the major springs of the Edwards Aquifer includes Comal, San Marcos, San Antonio, San Pedro, and Leona Springs. The average flow from all major springs during baseline conditions was 483 cfs and ranged from about 150 cfs in 1957 to over 900 in 1987. At Comal Springs, San Marcos Springs, and the combined flow of San Antonio and San Pedro Springs, the average flows were 325, 130, and 28 cfs, respectively. The model showed Leona Springs to be dry for all simulations; however, leakage rate of about 25 cfs in the Uvalde area may be considered to account for Leona Springs. However, this leakage was not added to the total of the five springs identified in the model.

**COMAL SPRINGS**

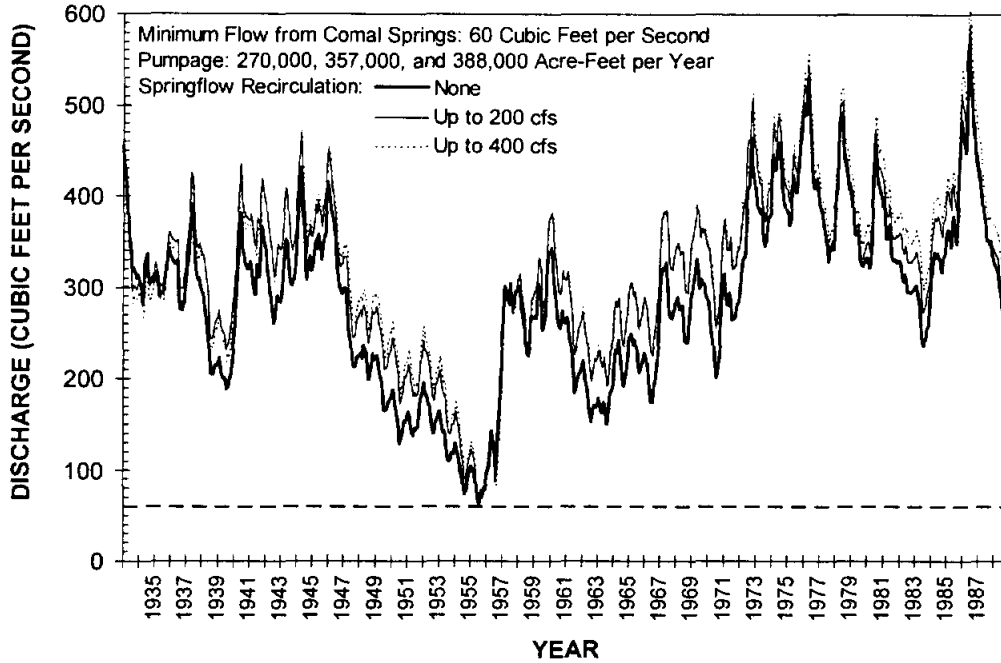

**COMAL SPRINGS - CHANGE IN FLOW**

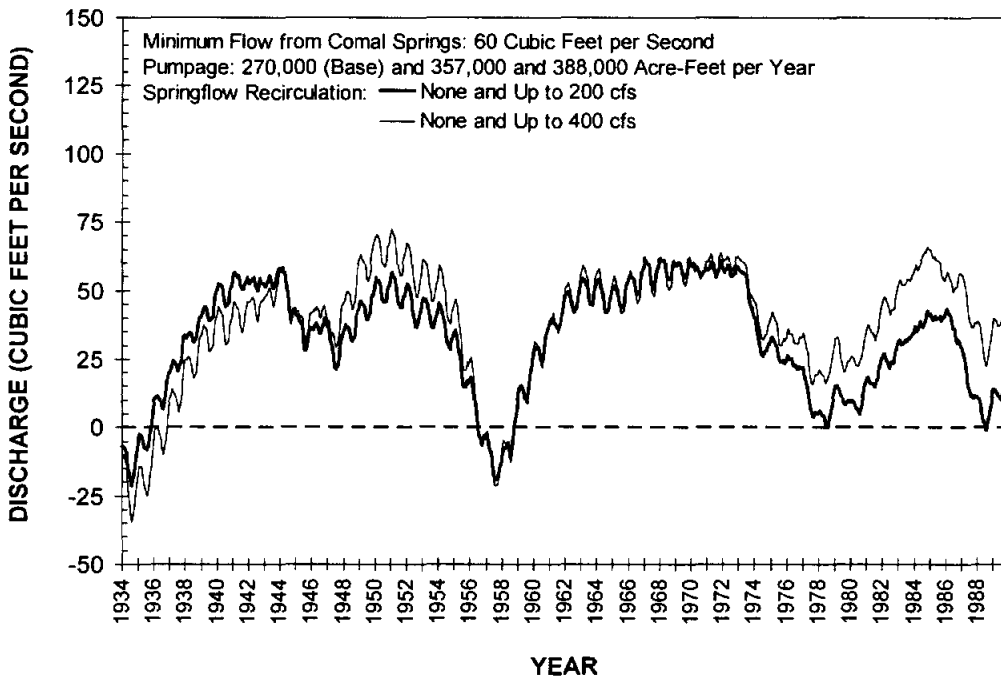

CONCEPTUAL EVALUATION OF  
 SPRINGFLOW RECIRCULATION

TRANS TEXAS WATER PROGRAM /  
 WEST CENTRAL STUDY AREA



HDR Engineering, Inc.

**COMPUTED FLOW FROM  
 COMAL SPRINGS**  
 "SUSTAINED YIELD" PUMPAGE

FIGURE 3.2-3

The impact of the 1950s drought is evident with declines in flow to less than 100 cfs for most of 3 years. The hydrograph shows rapid recoveries after the drought but they were short lived because of declines in the early 1960s. Beginning in the mid-1960s the springs recovery was moderate and steady until the early 1970s when recovery was again rapid. Since the early 1970s, flows appear to be substantially above normal except for short term droughts in 1984 and 1989.

The changes in the combined flow from all the springs show a pattern similar to Comal Springs (Figure 3.2-4). San Marcos Springs changed less than 5 cfs at any time. In contrast, flows from San Antonio and San Pedro Springs occur only during high water level conditions but only during the winter months when pumping is reduced. This flow caused the hydrograph showing changes in total springflow to take on a jagged pattern during the high water conditions in the early 1940s and after 1970. As with Comal Springs, turning the recirculation 'OFF' and 'ON' in northern Bexar County added to the erratic pattern. For the period from 1973 to 1989, the overall average flow from San Antonio and San Pedro Springs increased from an average of 9 cfs to 50 cfs for the 200 cfs rate, and from 9 to 75 cfs for the 400 cfs rate.

#### 3.2.1.5 Guadalupe River

A recirculation rate of up to 200 cfs was considered from Lake Dunlap, as described earlier. The springflow in the Guadalupe River at this location is equivalent to Comal Springs which is shown in (Figure 3.2-3). To show the impact of diversions on flows in the Guadalupe River at this location; the diversion rate calculated by the model is subtracted from the discharge of Comal Springs. This change in springflow in the Guadalupe River is shown in (Figure 3.2-5). The initial impact was the greatest, but tended to approach about 150 cfs in the mid-1940s, and early 1970s; but averaged 129 cfs. The sudden changes in springflows in the Guadalupe River that showed a net gain in flow occurred when the diversion was turned 'OFF' and back 'ON'. The graph shows the decrease in flows to become less severe during the low flow conditions of the 1950s drought. Overall, there was a reduction of 97 cfs in the Guadalupe River for the 200 cfs recirculation rate.

Diversion of the water for a recirculation rate of up to 400 cfs occurs from the Guadalupe River below the mouth of San Marcos River so that the diversion can include flow from Comal

**MAJOR SPRINGS**  
COMAL, SAN MARCOS, SAN ANTONIO, AND SAN PEDRO SPRINGS

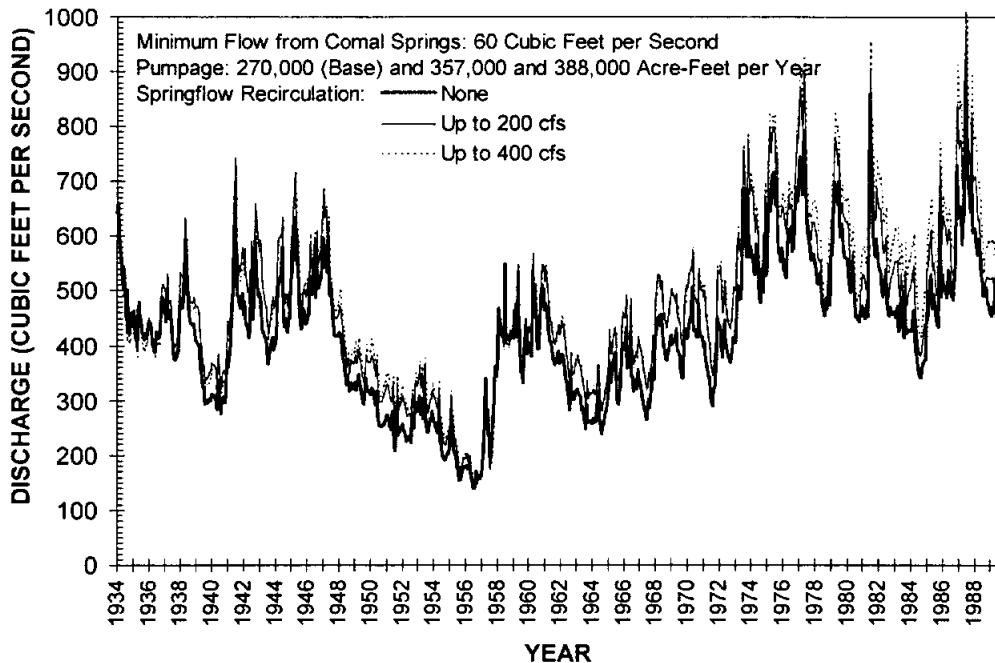

**MAJOR SPRINGS - CHANGE IN FLOW**

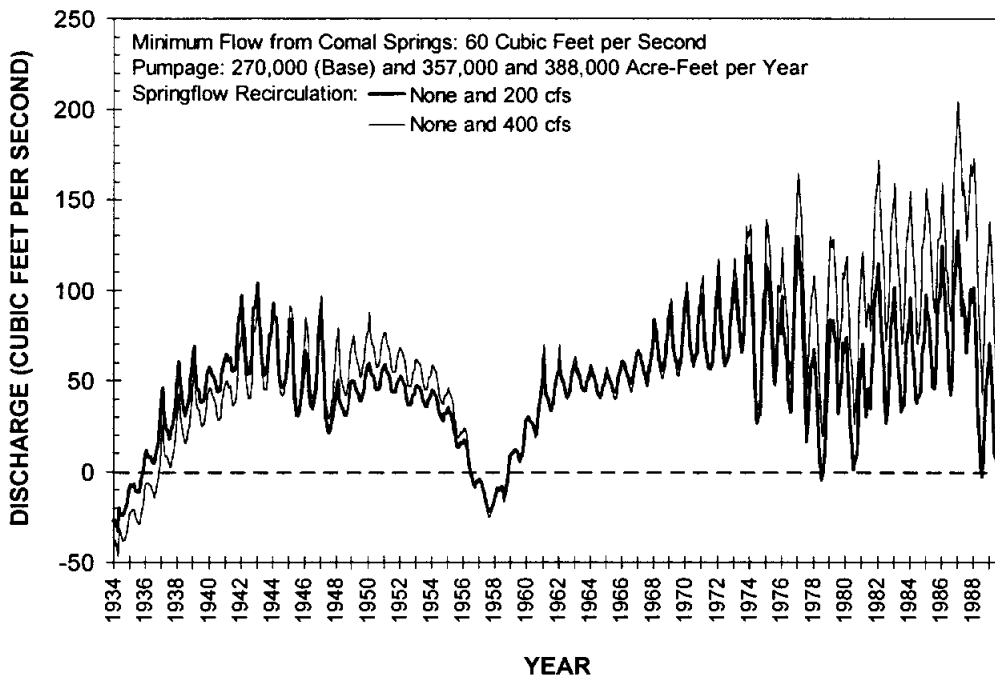

CONCEPTUAL EVALUATION OF  
SPRINGFLOW RECIRCULATION

TRANS TEXAS WATER PROGRAM /  
WEST CENTRAL STUDY AREA



HDR Engineering, Inc.

**COMPUTED FLOW FROM MAJOR  
SPRINGS OF EDWARDS AQUIFER  
"SUSTAINED YIELD" PUMPAGE**

FIGURE 3.2-4



**GUADALUPE RIVER  
CHANGE IN FLOW AFTER DIVERSION**

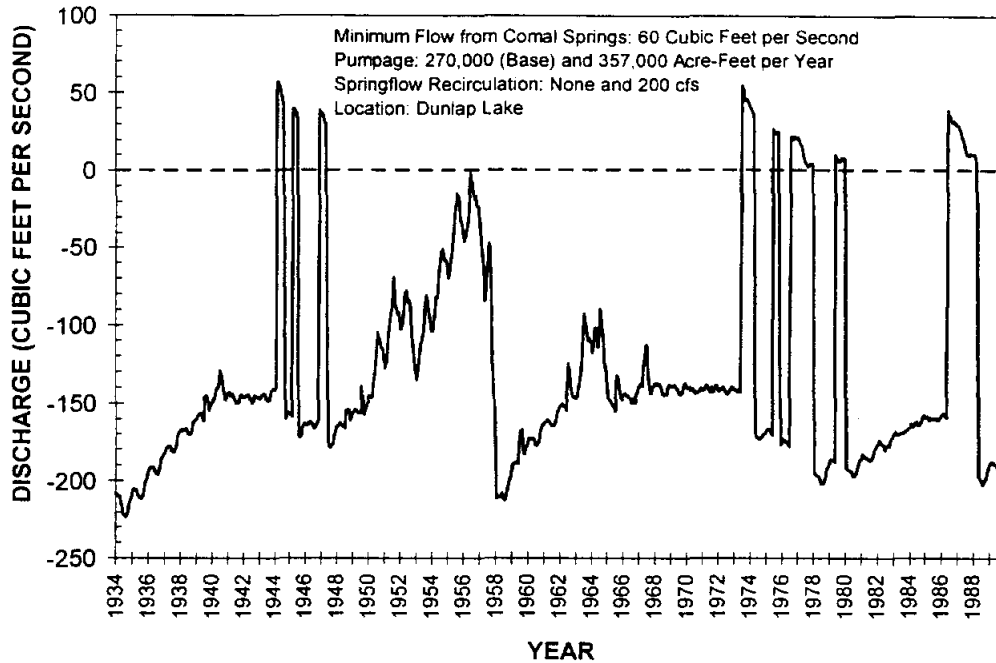

**GUADALUPE RIVER  
CHANGE IN FLOW AFTER DIVERSION**

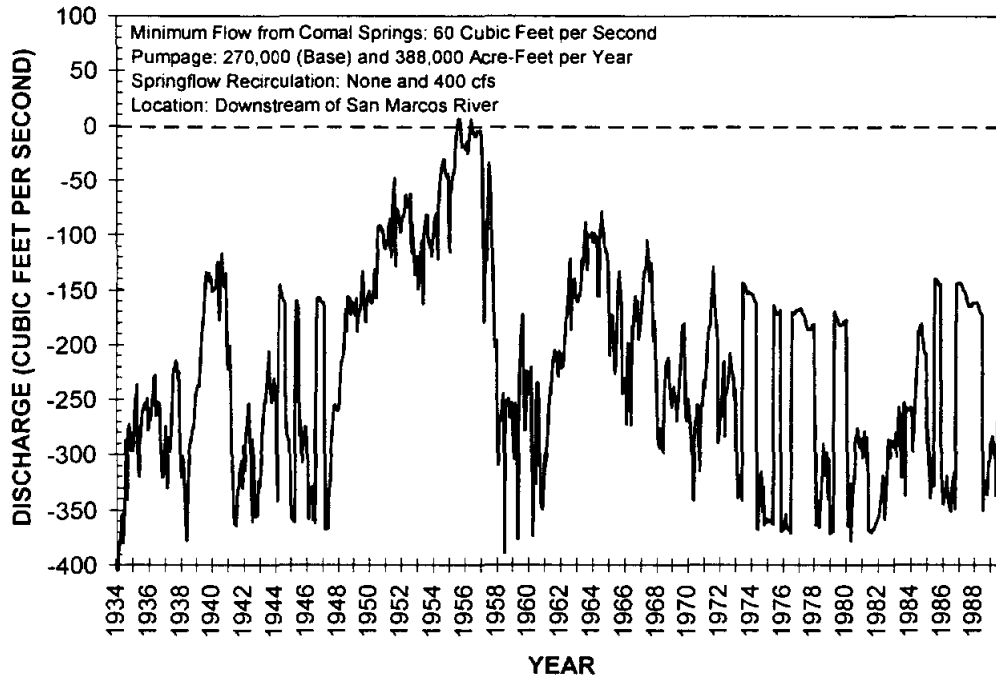

CONCEPTUAL EVALUATION OF  
 SPRINGFLOW RECIRCULATION

TRANS TEXAS WATER PROGRAM /  
 WEST CENTRAL STUDY AREA



HDR Engineering, Inc.

**COMPUTED CHANGE IN FLOW  
 GUADALUPE RIVER AFTER DIVERSION  
 "SUSTAINED YIELD" PUMPAGE**

FIGURE 3.2-5

Springs and San Marcos Springs. The average flow from the two springs was 456 cfs. The flow distribution for the 56-year test period is approximated by the major springs hydrograph shown in (Figure 3.2-4). To show the impact of the 400 cfs springflow recirculation diversion on flows in the Guadalupe River; the diversion rate as calculated by the model is subtracted from the combined discharge of Comal Springs and San Marcos Springs. As discussed earlier, the water available for diversion is limited to flows in excess of 160 cfs. The change in springflow in the Guadalupe River is shown in (Figure 3.2-5). As shown in the springflow recirculation graph (Figure 3.2-1), 400 cfs was available for diversion for only a small amount of the time. As a result, the average reduction from baseline conditions was 220 cfs. The square shaped spikes occurring after 1973 is in response to diversions being turned 'OFF' in both recharge areas.

#### 3.2.1.6 Water Levels

Water levels were calculated with the model at four locations. Two are in the outcrop areas; and, two are in the confined zone. The Hill Country monitoring well is located in the outcrop area of the Edwards Aquifer in northern Bexar County and was selected to be the index well for the Bexar County recharge area. The Seco Creek monitoring well is located northwest of the Medina Lake Fault and was selected to represent the water level conditions in the outcrop areas in the northwest part of the aquifer and in the Medina County recharge area. The J-17 well represents the San Antonio area; and, the Uvalde well represents the western part of the aquifer. Both are in the confined zone and are used as indices for declaring stages of drought management.

The calculated water levels in the Hill Country well averaged about 710 ft above mean sea level under conditions from 1934 to baseline 1947 and then declined until the cell nearly went dry at 660 ft in 1957. The model shows water level recoveries to about 725 ft in 1974 and to peak water levels of over 740 ft in 1977 and 1987 (Figure 3.2-6). For the two recirculation scenarios, the rise in water levels was very nearly the same. This is attributed to limiting recharge to 200 cfs in this area. During the test with springflow recirculation, water levels rose to an operating range of 745 and 750 ft which resulted in the recharge being turned 'OFF' and 'ON' several times in the 1940s and from 1973-1987.

### HILL COUNTRY WELL

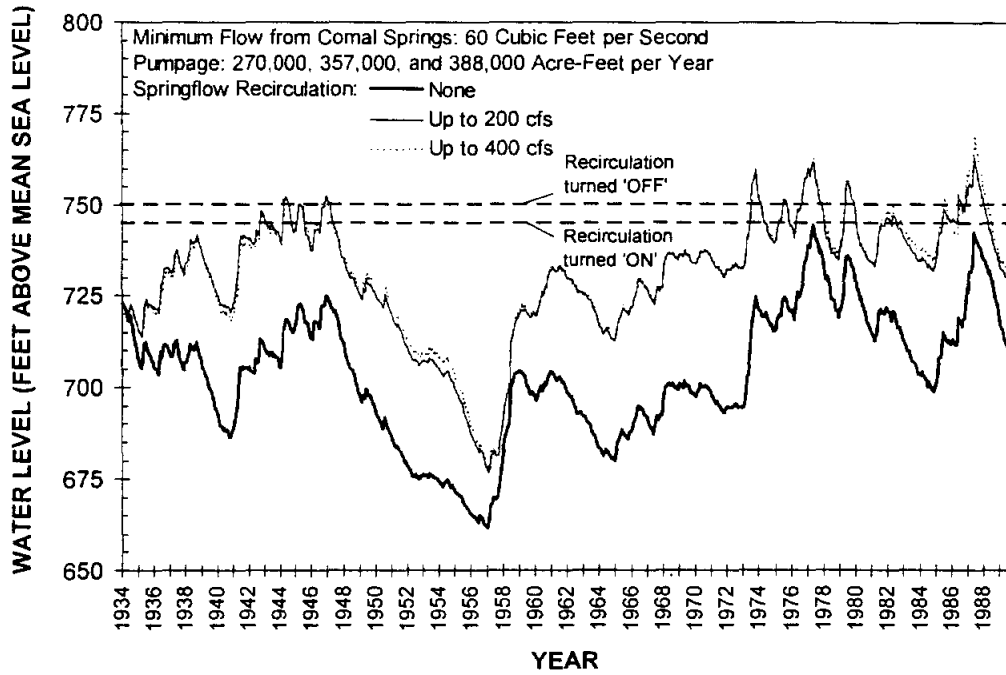

### SECO CREEK WELL

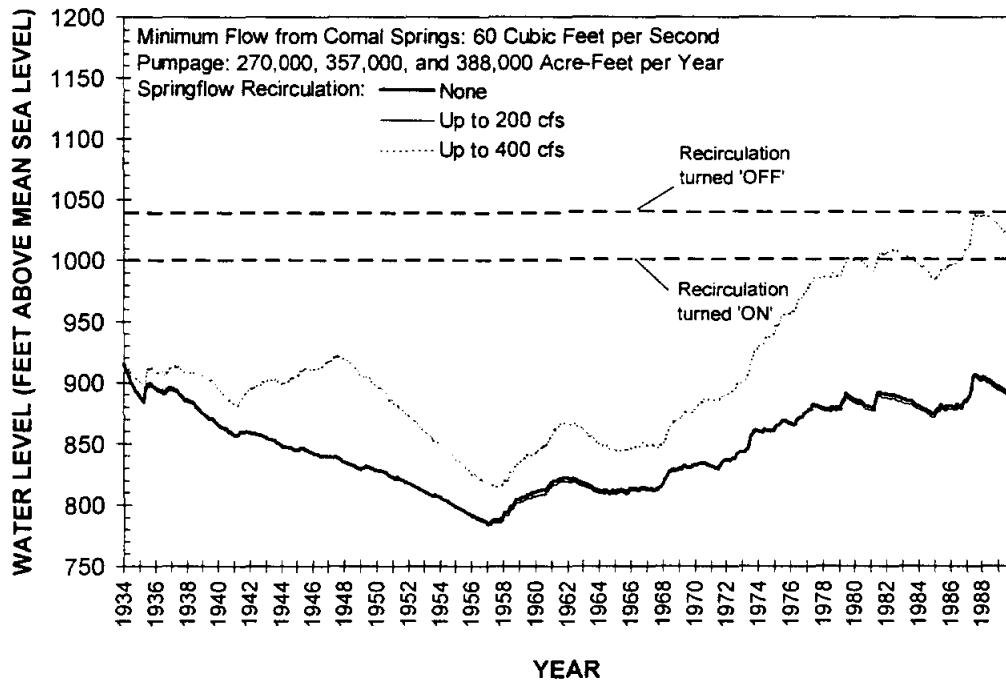

CONCEPTUAL EVALUATION OF  
 SPRINGFLOW RECIRCULATION

TRANS TEXAS WATER PROGRAM /  
 WEST CENTRAL STUDY AREA



HDR Engineering, Inc.

COMPUTED WATER LEVELS  
 AT INDEX WELLS  
 "SUSTAINED YIELD" PUMPAGE

FIGURE 3.2-6

The calculated water levels at the Seco Creek well location reflect a general decline of about 125 feet from 1934 to the worst part of the drought in 1957 and overall recovery to original water levels near the end of the 56-year simulation (Figure 3.2-6). For the 200 cfs recirculation rate, the water levels are almost identical to the baseline water levels, indicating recharge in the Bexar County area is effectively offsetting the increase in pumpage. However, for the recirculation rate of 400 cfs, the water levels increased about 80 ft higher than baseline conditions by 1947 and reached a maximum of 130 ft higher in 1987. The water levels never reached the elevation of 1040 ft at which point the recirculation would have been turned 'OFF.'

The calculated water levels at the J-17 well reflect the typical regional trend in ground water conditions with about normal water levels from 1934 to 1947, steady declines to about 600 ft by 1957, irregular recoveries until 1974 and generally higher than normal water levels after 1974 (Figure 3.2-7). Within the regional trends, there are annual pumping cycles where the summer pumping causes the water levels to decline about 20 ft below the winter recoveries. As with the Hill Country well, the combination of increased pumpage and recirculation produced similar rises in water levels above the baseline conditions until 1947. Afterwards, water levels with the 200 cfs recirculation rate increased water levels an average of about 4.1 ft while the 400 cfs scenario increased water levels an average of about 4.9 ft. Proposed drought management plans for the San Antonio area would impose pumpage reductions based on the J-17 well in the following stages: Stage I, 642-650 ft; Stage II, 636-642 ft; Stage III, 632-636 ft; Stage IV, 628-632; and Stage V, below 628. During the 1950s drought, water levels would have triggered restrictions for about a 9.9 year period for the baseline conditions. Both the 200 and 400 cfs recirculation rates would have reduced this to 5.5 years. The runs showed that the most severe restrictions would have been in place for part of one summer for the baseline conditions and parts of two summers with either of the recirculation plans.

The baseline water levels calculated by the model at the Uvalde monitoring well reflects the regional water level pattern with water levels at about 850 ft at the start of the period, declining to about 790 ft during the worst part of the drought, and recovering to about 860 ft at the end of the period (Figure 3.2-8). Each year, there is an annual cycle with a range of about 30 ft which appeared to be caused by local and regional pumping. For the 200 cfs recirculation plan, the increase in pumpage from 270,000 to 357,000 ac-ft/yr causes the water levels to be

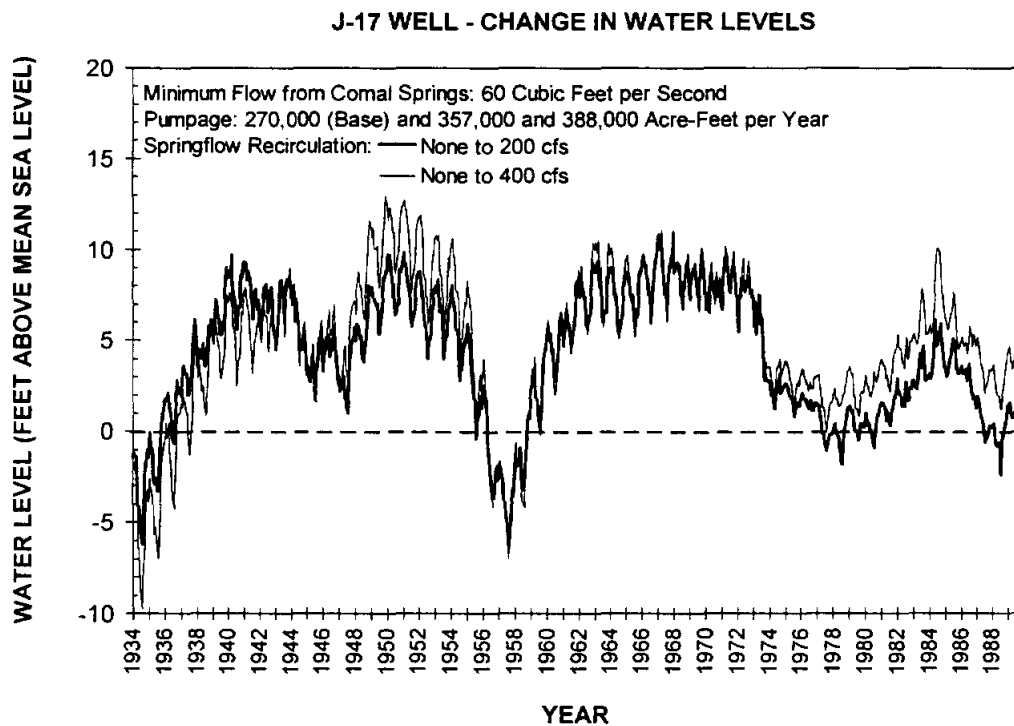
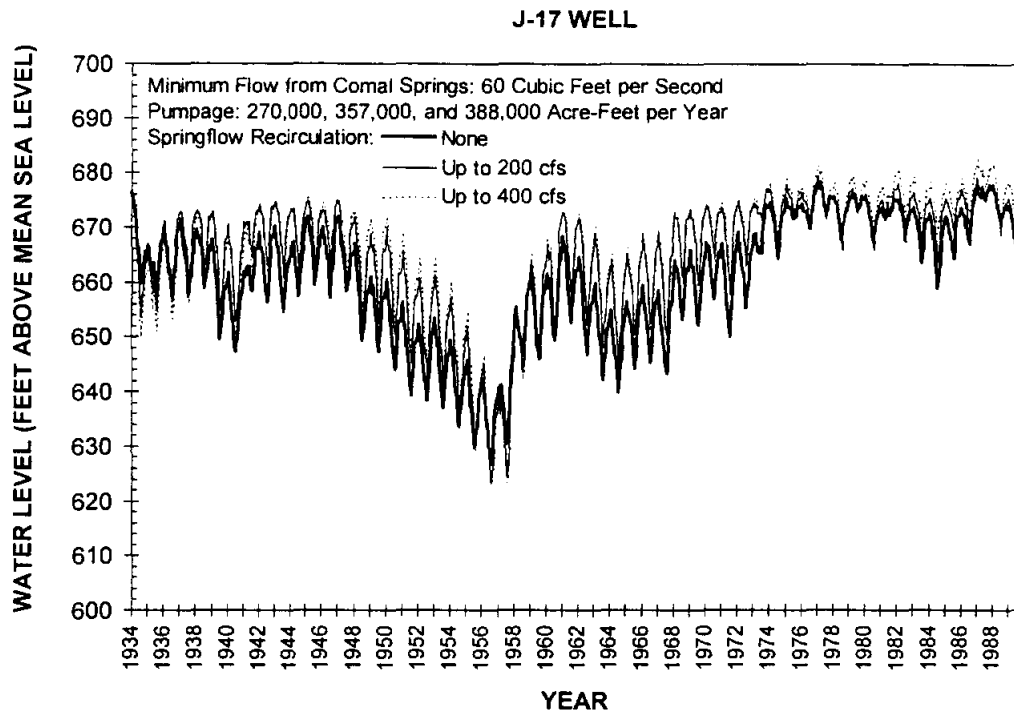

CONCEPTUAL EVALUATION OF  
 SPRINGFLOW RECIRCULATION

TRANS TEXAS WATER PROGRAM /  
 WEST CENTRAL STUDY AREA



HDR Engineering, Inc.

COMPUTED WATER LEVELS  
 AT J-17 INDEX WELL  
 "SUSTAINED YIELD" PUMPAGE

FIGURE 3.2-7

### UVALDE WELL

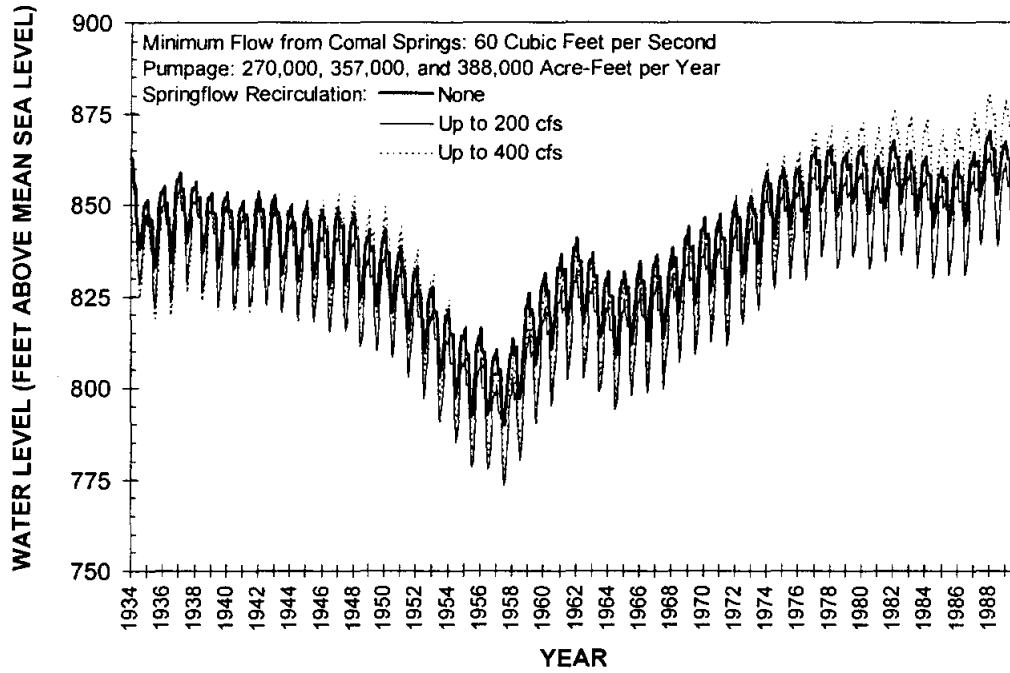

### UVALDE WELL - CHANGE IN WATER LEVELS

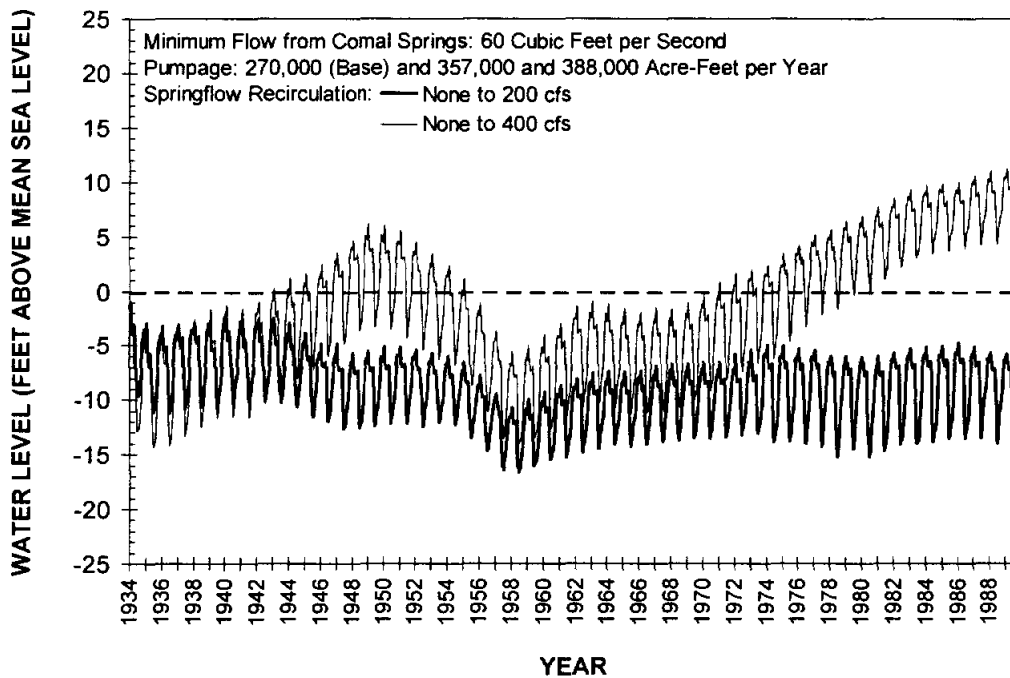

CONCEPTUAL EVALUATION OF  
 SPRINGFLOW RECIRCULATION

TRANS TEXAS WATER PROGRAM /  
 WEST CENTRAL STUDY AREA



HDR Engineering, Inc.

COMPUTED WATER LEVELS  
 AT UVALDE INDEX WELL  
 "SUSTAINED YIELD" PUMPAGE

FIGURE 3.2-8

about 10 ft lower than baseline conditions. However, for the 400 cfs recirculation where there was recharge in the western part of the aquifer, the water levels eventually rose to nearly 10 ft above the baseline conditions. If the 200 cfs management plan was implemented along with increased pumpage, the water use restrictions would be longer, more frequent and possibly more severe for this part of the aquifer than with baseline conditions. However, if the 400 cfs management plan was implemented, the percent of time restrictions would occur is reduced because of the generally higher water levels.

### 3.2.2 Surface Water

#### 3.2.2.1 Streamflows and Water Rights Availability

Simulated median monthly streamflows for the 1934-89 period under the “sustained yield” Edwards Aquifer pumpage management plan are shown in (Figure 3.2-9) for several key locations in the Guadalupe and San Antonio River basins. For comparative purposes the results of the two recirculation rates are shown along with the baseline case of no recirculation. The “sustained yield” pumpage with no recirculation was 270,000 ac-ft/yr and is increased to 357,000 ac-ft/yr with 200 cfs recirculation (Section 3.2.1).

At the H-5 Dam near Gonzales, the diversion of up to 200 cfs for recirculation led to decreases in median monthly streamflows which ranged from approximately 9,000 - 12,000 ac-ft/mo. The decreases are greater than those seen under the 400,000 ac-ft/yr management plan where they ranged from 5,000 - 8,000 ac-ft/mo (Section 3.1.2.1 and Figure 3.1-9) because Edwards Aquifer pumpage here is also increasing between the baseline case and the recirculation cases.

For the 400 cfs recirculation, the “sustained yield” pumpage was increased to 388,000 ac-ft/yr (Section 3.2.1). Under this case Comal Springs discharges are influenced by a combination of the increased recharge and greater pumpage from the aquifer. The net result of this is seen on (Figure 3.2-9) for the H-5 location with increases in median streamflows differing from the baseline by only about +1,000 to +3,000 ac-ft/mo.

At Cuero and at the Saltwater Barrier near Tivoli, the median monthly streamflow pattern showed decreases for all months under both recirculation rates because the diversion locations

GUADALUPE RIVER AT H-5 DAM

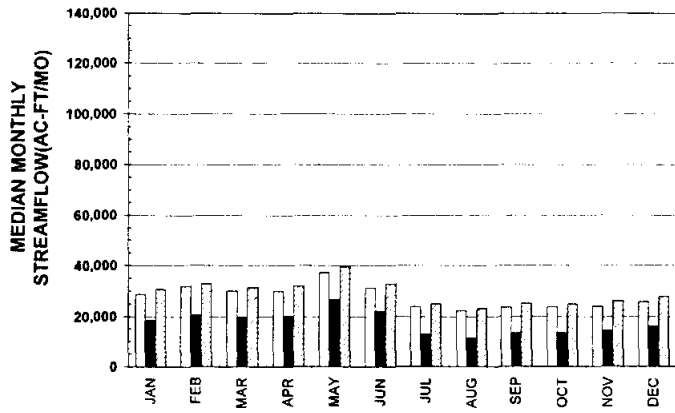

GUADALUPE RIVER AT CUERO

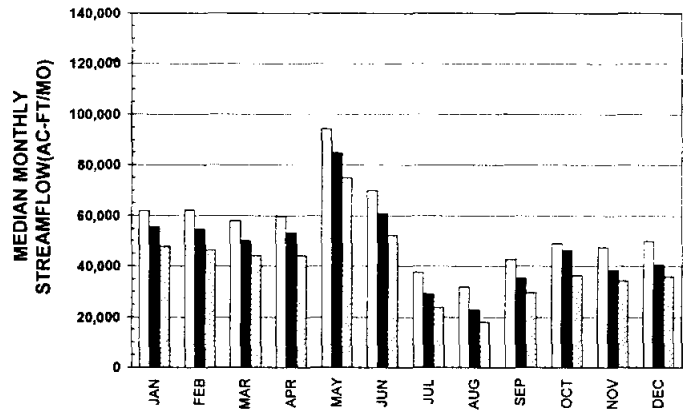

GUADALUPE RIVER AT SALT WATER BARRIER

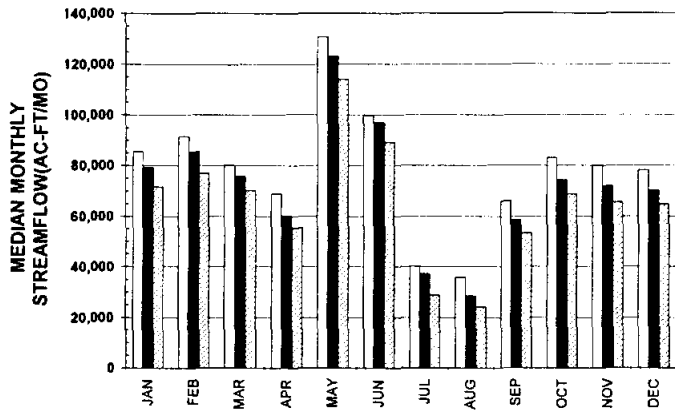

SAN ANTONIO RIVER AT FALLS CITY

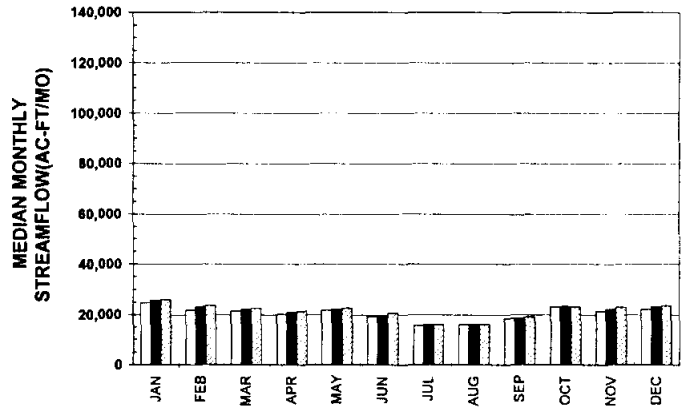

SAN MARCOS RIVER AT LULING

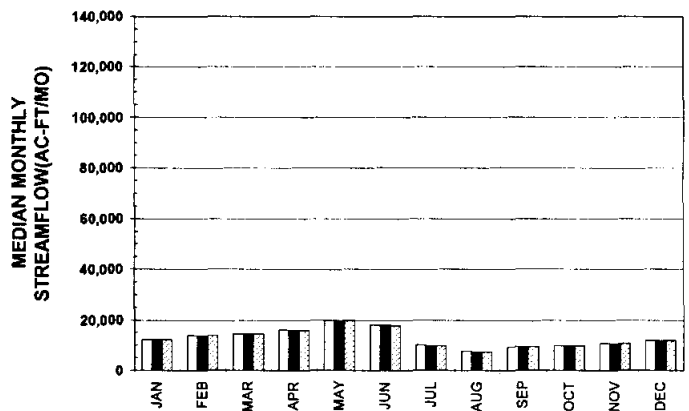

- Baseline: No recirculation  
(Aquifer Pumpage = 270,000 ac-ft/yr)
- Recirculation up to 200 cfs  
(Aquifer Pumpage = 357,000 ac-ft/yr)
- ▨ Recirculation up to 400 cfs  
(Aquifer Pumpage = 388,000 ac-ft/yr)

CONCEPTUAL EVALUATION OF  
SPRINGFLOW RECIRCULATION



HDR Engineering, Inc.

TRANS TEXAS WATER PROGRAM /  
WEST CENTRAL STUDY AREA

MEDIAN MONTHLY STREAMFLOWS  
GUADALUPE - SAN ANTONIO  
RIVER BASIN

"SUSTAINED YIELD" PUMPAGE

FIGURE 3.2-9



were both upstream of these points. For example, at the Saltwater Barrier location, the 200 cfs recirculation led to decreases in median monthly streamflows ranging from about 3,000 to 9,000 ac-ft/mo.

For the two other locations, the San Antonio River near Falls City and the San Marcos River near Luling the monthly median streamflows have a mixed pattern ranging from small increases to very small decreases. This mixed pattern is due to the competing influences of (1) a tendency for springflows to increase as the recirculation of river water for Edwards Aquifer recharge is increased, and (2) the tendency toward reduced springflows as pumpage from the aquifer under the “sustained yield” management plan is increased. Figure 3.2-10 portrays flow frequency plots for these same locations under the three variations of the “sustained yield” management plan.

A summary of the effects of the recirculation of springflows on existing water rights is portrayed in Table 3.2-1. Again, the recirculation generally has very little effect on water rights, except for the very large rights at the extreme lower end of the basin near the Saltwater Barrier. For example, under the baseline case of “sustained yield” pumpage from the Edwards Aquifer and no recirculation, an average shortage of 4,862 ac-ft/yr over the entire 56-year period would occur at the Saltwater Barrier. This would increase to 7,092 ac-ft/yr subject to the recirculation of up to 200 cfs and to 8,054 ac-ft/yr for the 400 cfs recirculation rate.

<b>Table 3.2-1.</b>						
<b>Summary of Water Rights Shortages and Canyon Reservoir Firm Yield for “Sustained Yield” Pumpage</b>						
Location	Total Water Rights (ac-ft)	Shortage or Yield in ac-ft/yr				
		Baseline no Recirculation	Up to 200 cfs Recirculation	Δ	Up to 400 cfs Recirculation	Δ
<b>Long-Term (1934-89) Average</b>						
Guadalupe Riv., Victoria	23,806	0	0	0	0	0
Guadalupe Riv., Saltwater Barrier	220,433	4,862	7,092	2,230	8,054	3,192
San Antonio Riv., Falls City	9,311	0	0	0	0	0
<b>Drought (1947-56) Average</b>						
Guadalupe Riv., Victoria	23,806	0	0	0	0	0
Guadalupe Riv., Saltwater Barrier	220,433	18,887	23,789	4,901	24,112	5,225
San Antonio Riv., Falls City	9,311	0	0	0	0	0
Canyon Lake firm yield		87,124	86,492	-632	86,253	-871

GUADALUPE RIVER AT H-5 DAM

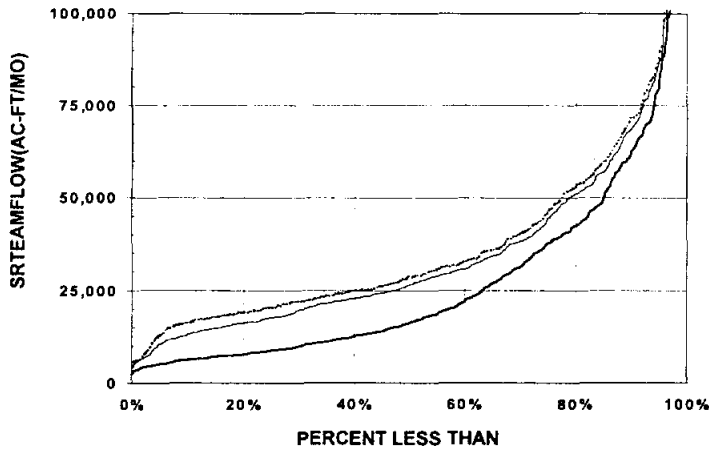

GUADALUPE RIVER AT CUERO

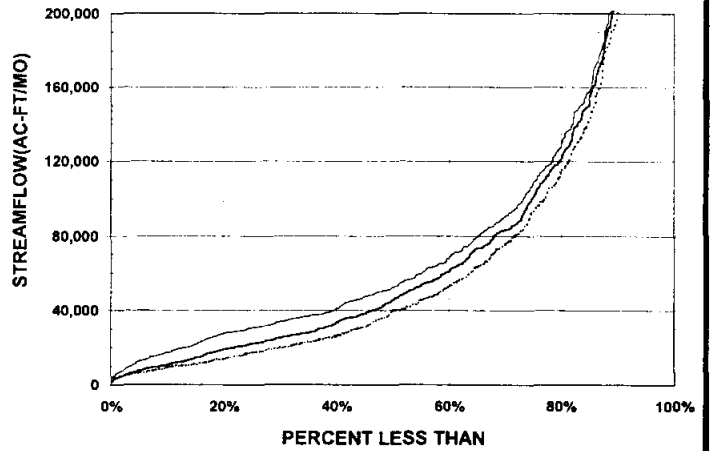

GUADALUPE RIVER AT SALT WATER BARRIER

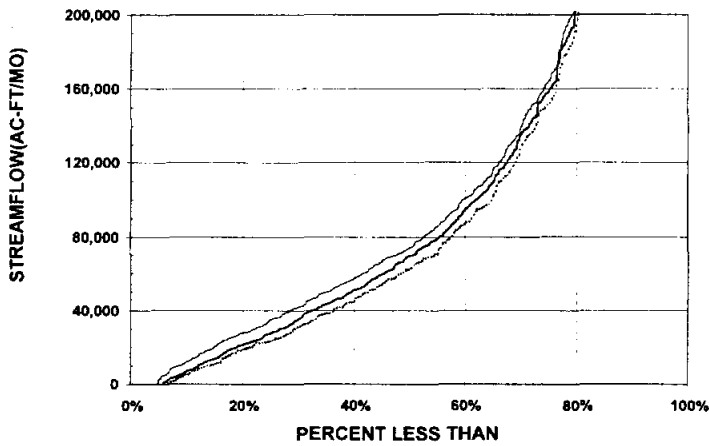

SAN ANTONIO RIVER AT FALLS CITY

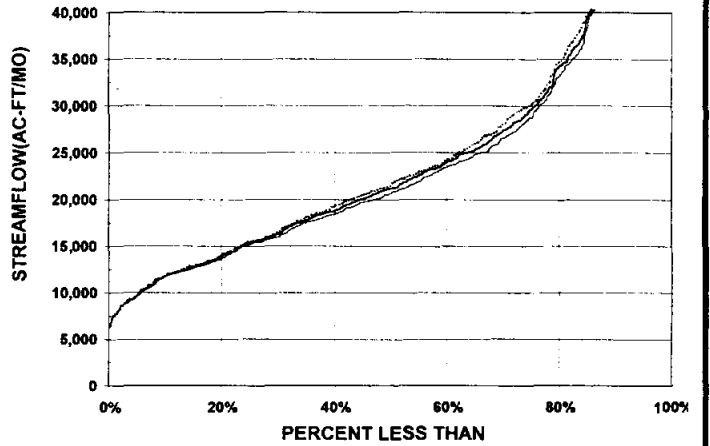

SAN MARCOS RIVER AT LULING

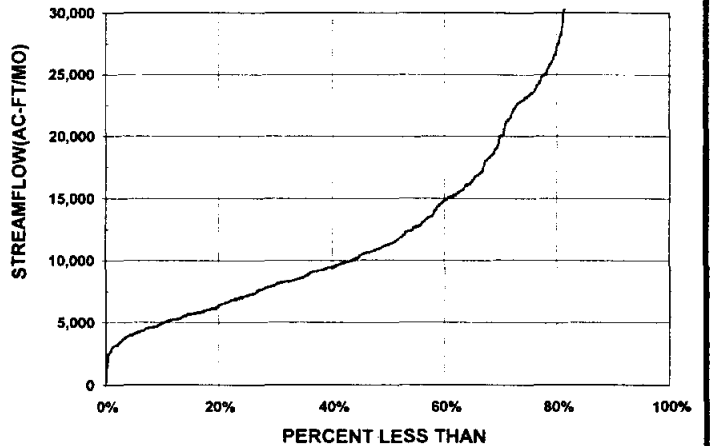

- Baseline: No recirculation  
(Aquifer Pumpage = 270,000 ac-ft/yr)
- Recirculation up to 200 cfs  
(Aquifer Pumpage = 357,000 ac-ft/yr)
- • • Recirculation up to 400 cfs  
(Aquifer Pumpage = 388,000 ac-ft/yr)

CONCEPTUAL EVALUATION OF  
SPRINGFLOW RECIRCULATION



HDR Engineering, Inc.

TRANS TEXAS WATER PROGRAM /  
WEST CENTRAL STUDY AREA

FLOW FREQUENCY CURVES  
GUADALUPE - SAN ANTONIO  
RIVER BASIN

"SUSTAINED YIELD" PUMPAGE

FIGURE 3.2-10

The bottom portion of Table 3.2-1 portrays the simulated impacts on existing water rights during the 1947-56 critical drought period. These shortages are increased by 4,901 and 5,225 ac-ft/yr over the baseline shortages for the 200 cfs and 400 cfs recirculation rates, respectively. The lower portion of Table 3.2-1 also summarizes the small effects of the recirculation on Canyon Lake firm yield. The simulated decreases in Canyon Lake firm yield for the 200 cfs and the 400 cfs recirculation cases represent less than 1 percent of the baseline firm yield.

It is important to note that these increased shortages could be fully mitigated by reducing the recirculation diversion rate at these times when water is needed by these senior water rights. This would decrease the volume of water available for recirculation and reduce the “sustained yield” by an estimated 2,000 to 3,000 ac-ft/yr for either recirculation scenarios.

### 3.2.2.2 Guadalupe Estuary Fisheries Harvest

Table 3.2-2 summarizes the simulated Guadalupe Estuary fisheries harvest for the “sustained yield” management plan under the three variations of recirculation. Again, as under the 400,000 ac-ft/yr management plan, there are a mixture of generally small increases and decreases in predicted harvest depending upon the particular species. More detailed data on Guadalupe Estuary fisheries harvest for the baseline and two recirculation test of this management plan are presented in Appendix A.

<b>Table 3.2-2. Summary of Fisheries Harvest Estimates for the Guadalupe Estuary “Sustained Yield” Pumpage</b>					
Species (klbs)	Baseline no Recirculation	Up to 200 cfs Recirculation	Δ	Up to 400 cfs Recirculation	Δ
White Shrimp	803	818	+15.0	820	+17.0
Brown Shrimp	391	395	+4.0	321	+0.0
Blue Crab	219	210	-9.0	208	-11.0
Eastern Oyster	489	478	-11.0	456	-33.0
Black Drum	27	26	-1.0	25	-2.0
Red Drum	74	73	-1.0	72	-2.0
Seatrout	57	57	+0.0	57	+0.0

(This page intentionally left blank.)

#### 4.0 DISCUSSION OF GROUND WATER MODELING RESULTS

Application of the GWSIM4 Model in the conceptual evaluation of springflow recirculation implies acceptance of at least four major assumptions as valid. These assumptions are: (1) the hydrogeology of the aquifer is reasonably well understood and the many descriptive parameters are mapped across the aquifer correctly, (2) the model is mathematically sound, is properly applied, and sufficiently calibrated, (3) the pumpage estimates are reasonable and accurately distributed in time and space, and (4) the recharge estimates are reasonable and accurately distributed in time and space. Because the conceptual management plans are evaluated primarily by comparison of model runs with a baseline run, errors or model biases are expected to have a similar effect in each test. In other words, calculated water levels, springflow, and leakage from the model may have limited accuracy; but, the calculated differences between tests may be assumed reasonable.

In reviewing the history of the GWSIM4 model, the code was developed in the 1970s for use on mainframe computers (Prickett and Lonquist, 1971).<sup>1</sup> In the mid- to late-1970s, the TWDB applied the model to the Edwards Aquifer in the San Antonio area using best available data and computers (Klemt and others, 1979).<sup>2</sup> Since then, TWDB and others have repeatedly used the original model and a refined version as a management tool and the results have been widely accepted. However, the model is characteristic of its original design and constraints (i.e., the goal of making long term and generalized projections is constrained by a limited understanding of the hydrogeology at the time, limited computer power by current standards, and very laborious data preparation tasks). As a result, the model is dated in several ways. A modern version would be expected to have: (1) a grid that could be regenerated to match details required by the goals of the modeling objective, (2) an hydrogeologic representation that takes into account the hydrogeologic research that has been done in the last 20 years, (3) a means of entering data, especially time dependent data, in a user-friendly manner, (4) a code that can be easily modified for special designs and tests, (5) graphical processors to readily visualize the data

---

<sup>1</sup> Prickett, T.A. and Lonquist, C.G. "Selected digital Computer techniques for ground water resource evaluation" Illinois Water Survey Bulletin 55, 1971.

<sup>2</sup> Klemt, W.B., Knowles, T.R., Elder, G.R., and Sieh, T.W. "Ground-water resources and model applications for the Edwards (Balcones Fault Zone) Aquifer in the San Antonio region, Texas "Texas Water Development Board Rep 239, 1979.

and results, and (6) a design that would facilitate the use as a day-to-day management model that could test the impact of such requests as well permits or recharge/discharge offsets.

Considering the issue of assessing the reliability of the results of the runs made in this report, some potential weaknesses, but no critical shortcomings, are noted. Based on previous studies and professional experience, these weaknesses include:

- The simulated flow from Comal Springs tends to be much too low when actual flow is between 100 and 300 cfs and too high when actual flow was below 50 cfs during the drought of the 1950s. This could be caused by a combination of model calibration and accuracy of the natural recharge, measured springflow discharges, and estimated pumpage. This discrepancy would make the calculations by the model during the critical low flow period of this report appear more favorable than they really are. For example, the "sustained yields" could be less than reported by this study and the duration of the hypothetical drought could be longer than estimated.
- The simulated flow from San Marcos Springs tends to be too low except for drought conditions.
- The simulated flows from San Antonio and San Pedro Springs appear to be about two times more than they should be. Based on correlations with the J-17 index well, this would explain at least part of the erratic springflow patterns noted in this report.
- The simulated water levels in J-17 tend to be too low during normal and above normal water level conditions in the aquifer. The difference is most pronounced after 1977.
- The simulated water levels in the Hill Country Well appear to be about 10 ft too low until the mid-1980s. Then, the match between simulated and measured water levels is generally within a few feet.
- The simulated water levels in the Seco Creek Well show that the water levels in this part of the aquifer are less responsive to major recharge events than the measured water levels indicate.
- The simulated water levels in the Uvalde Well show a reasonable fit during the 1950s drought; but they are much too low after 1977 and show too great a response to seasonal pumping.
- The aquifer permeabilities in the model for the targeted recharge area in Bexar County varied largely without an organized pattern and only partly account for faults in the area. This would show recharge water to migrate more easily to wells in the San Antonio area instead of Comal Springs than may be actually possible. The result would be higher water levels in the San Antonio area and delayed increase in flows at Comal Springs.
- The aquifer permeabilities in the model for northern Medina County tend to be isotropic and follow a regional pattern. The exception is a major fault that acts as a barrier to flow directly from the recharge area in Medina County to the central part of the confined zone.

## 5.0 PROJECT ENGINEERING AND COST ESTIMATES

Two diversion and recharge options were evaluated with respect to sizing of facilities and costs for the recirculation of flow from Comal and San Marcos Springs. One of the options has a capacity of 200 cfs, withdraws water from Lake Dunlap near New Braunfels, and recharges the Edwards Aquifer in northwestern Bexar County (Figure 5.0-1). The other option has a recirculation capacity of up to 400 cfs, and recharges up to 200 cfs of this in northwestern Bexar County and up to 200 cfs in northern Medina County (Figure 5.0-2). In Sections 2 and 3 of this report, all of the water in the 400 cfs recirculation tests was assumed to be diverted below the influence of the Guadalupe and San Marcos Rivers. However, for cost estimation purposes of this section, it was assumed that up to 200 cfs would be withdrawn from Lake Dunlap and up to 200 cfs withdrawn from near Gonzales.

Major facilities to transport the water from the Guadalupe River to the recharge sites include:

- Intake and pump stations
- Raw water pipelines and laterals and booster stations
- Water treatment plant (direct filtration for water diverted from near Gonzales only)
- Recharge structures.

Depending on the option, the intake structures and associated pump stations are located on the shores of Lake Dunlap and Guadalupe River at Gonzales. Raw water pipelines are sized to match the design capacities and booster stations are included as necessary to maintain design capacities and pressures. For the higher turbidity water diverted near Gonzales, water may need to be treated. Therefore, costs have been included for treatment of this water through direct filtration treatment which involves: (1) addition of alum and polymer, (2) rapid mixing, (3) flocculation, (4) settling, and (5) gravity filtration. Within the recharge area, pipelines will transport the water to either the upper reaches of target streams which directly recharge the aquifer or directly to small capacity recharge dams. The main pipeline is stepped down in size after each water delivery site.

One means of recharging the Edwards Aquifer with recirculated springflow is to utilize natural channel losses in the recharge zone of the Edwards Aquifer. To take advantage of these “losses”, water is released in the target stream near the upper limit of the recharge zone and

allowed to flow uncontrolled across the recharge zone. Near the end of the stream segment on the recharge zone, a recharge reservoir captures any remaining water that did not percolate through the streambed. Suitable reservoirs or recharge facilities exist on Panther Springs Creek, tributaries to Salado Creek, San Geranimo Creek, Verde Creek, Parkers Creek, and Seco Creek. Ongoing recharge enhancement studies are recommending a new reservoir on Hondo Creek. Thus, the only additional reservoirs associated with this study are on Culebra Creek and Government Canyon Creek. Cost estimates include all reservoirs that do not exist.

For the management plan with aquifer pumpage of 400,000 ac-ft/yr and a simulated recirculation rate of 200 cfs, a long-term average of 98,400 ac-ft/yr would be recharged at an annual cost of \$28,649,000 (Table 5.1-1). During drought conditions, equivalent to 1947-56, an average of 60,600 ac-ft/yr would be recharged at an average annual cost of \$24,906,000. The average annual cost of recirculated recharge at the 200 cfs recirculation rate would range from \$291/ac-ft on the long-term to \$411/ac-ft during drought. For a simulated recirculation rate of up to 400 cfs, an average of 162,800 ac-ft/yr would be recharged at an average annual cost of \$88,876,000 (Table 5.1-2). During drought conditions, an average of 96,300 ac-ft/yr would be recharged at an average annual cost of \$82,552,000. The average annual cost of recirculated recharge at the 400 cfs recirculation rate would range from \$546/ac-ft on the long-term to \$857/ac-ft during drought. The incremental unit costs for the increased recirculated recharge provided by the 400 cfs option indicate that it may not prove economical as these costs range from \$935 to \$1,615 per ac-ft as shown in Table 5.1-2. Since the measure of improvement due to recirculation for the 400,000 ac-ft/yr pumpage options is in terms of reduced periods of time of mandatory water use restrictions rather than increases in pumpage, annual costs for recirculated recharge should be compared to those for other natural recharge alternatives.

For the management plan with a "sustained yield" pumpage and a simulated recirculation rate of 200 cfs, Edwards Aquifer pumpage is increased by about 87,000 ac-ft/yr. This increased pumpage would be at a unit cost of \$350 per ac-ft under long-term average conditions (Table 5.1-3). During drought conditions when less water is recharged and power costs are reduced, the unit cost decreases to \$326 per ac-ft. These unit costs for increased "sustained yield" are comparable to unit costs for surface water reservoirs and other firm water supply alternatives. For comparison with natural recharge alternatives, annual costs of recirculated



recharge at the 200 cfs recirculation rate would range from \$261/ac-ft on the long-term to \$296/ac-ft during drought.

For the option with a recirculation rate of up to 400 cfs, the “sustained yield” pumpage is increased by 118,000 ac-ft/yr. For this option, the long-term average unit cost is \$774 per ac-ft (Table 5.1-4). During drought conditions, unit cost is reduced to \$717 per ac-ft as pumping costs are reduced. For comparison with natural recharge alternatives, annual costs of recirculated recharge at the 400 cfs recirculation rate would range from \$490/ac-ft on the long-term to \$720/ac-ft during drought. The incremental unit costs for the increased “sustained yield” pumpage or recirculated recharge provided by the 400 cfs option indicate that it may not prove economical as these costs range from \$875 to \$2,605 per ac-ft as shown in Table 5.1-4.

**Table 5.1-1**  
**Cost Estimate Summaries for 400,000 ac-ft/yr Aquifer Pumpage**  
**with up to 200 cfs Diversions from Lake Dunlap to Northwestern Bexar County**  
**(L-22A)**  
**(First Quarter 1996 Prices)**

Item	Average Annual Diversion to Recharge Zone	Drought (1) Annual Diversion to Recharge Zone
<b>Capital Costs</b>		
Transmission and Pumping	\$123,936,000	
Treatment Plant	0	
New Reservoirs	<u>4,020,000</u>	
<b>Total Capital Costs</b>	<b>\$127,956,000</b>	
Engineering, Contingencies, and Legal Costs	\$38,810,000	
Land Acquisition	1,630,000	
Environmental Studies and Mitigation	1,678,000	
Interest During Construction	<u>8,164,000</u>	
<b>Total Project Costs</b>	<b>\$178,238,000</b>	
<b>Annual Costs</b>		
Annual Debt Service	\$16,754,000	\$16,754,000
Annual Operation and Maintenance	2,243,000	2,243,000
Annual Power Costs	<u>9,652,000</u>	<u>5,909,000</u>
<b>Total Annual Costs</b>	<b>\$28,649,000</b>	<b>\$24,906,000</b>
Average Annual Recirculated Recharge <sup>(2)</sup> (acft/yr)	98,400	60,600
Annual Cost of Recirculated Recharge	\$291/acft	\$411/acft
Notes:		
(1) Drought annual averages for 1947-56 historical period		
(2) Recirculated recharge is springflow diverted below Comal Springs, delivered via transmission pipeline to Northwestern Bexar County, and allowed to recharge the Edwards Aquifer		

**Table 5.1-2**  
**Cost Estimate Summaries for 400,000 ac-ft/yr Aquifer Pumpage**  
**with up to 400 cfs Diversions from Lake Dunlap and Gonzales and**  
**Recharge to Northwestern Bexar County and Northern Medina County**  
**(L-22B)**  
**(First Quarter 1996 Prices)**

Item	Average Annual Diversion to Recharge Zone	Drought (1) Annual Diversion to Recharge Zone
<b>Capital Costs</b>		
Transmission and Pumping	\$425,010,000	
Treatment Plant	30,121,000	
New Reservoirs	<u>5,360,000</u>	
<b>Total Capital Costs</b>	<b>\$460,491,000</b>	
Engineering, Contingencies, and Legal Costs	\$141,252,000	
Land Acquisition	3,558,000	
Environmental Studies and Mitigation	3,542,000	
Interest During Construction	<u>29,224,000</u>	
<b>Total Project Costs</b>	<b>\$638,067,000</b>	
<b>Annual Costs</b>		
Annual Debt Service	\$59,978,000	\$59,978,000
Annual Operation and Maintenance	13,434,000	13,434,000
Annual Power Costs	<u>15,464,000</u>	<u>9,140,000</u>
<b>Total Annual Costs</b>	<b>\$88,876,000</b>	<b>\$82,552,000</b>
Average Annual Recirculated Recharge <sup>(2)</sup> (acft/yr)	162,800	96,300
Annual Cost of Recirculated Recharge	\$546/acft	\$857/acft
Incremental Total Annual Cost Increase Above 200 cfs	\$60,227,000	\$57,646,000
Incremental Increase in Average Annual Recirculated Recharge Above 200 cfs (acft/yr)	64,400	35,700
Incremental Annual Cost of Recirculated Recharge Above 200 cfs	\$935/acft	\$1,615/acft
Notes:		
(1) Drought annual averages for 1947-56 historical period.		
(2) Recirculated recharge is springflow diverted from the Guadalupe River at Lake Dunlap and near Gonzales, delivered via transmission pipelines to northwestern Bexar County and northern Medina County, and allowed to recharge the Edwards Aquifer.		

**Table 5.1-3**  
**Cost Estimate Summaries for "Sustained Yield"<sup>(1)</sup> Aquifer Pumpage**  
**with up to 200 cfs Diversions from Lake Dunlap to Northwestern Bexar County**  
**(L-23A)**  
**(First Quarter 1996 Prices)**

Item	Average Annual Diversion to Recharge Zone	Drought <sup>(2)</sup> Annual Diversion to Recharge Zone
<b>Capital Costs</b>		
Transmission and Pumping	\$123,936,000	
Treatment Plant	0	
New Reservoirs	<u>4,020,000</u>	
<b>Total Capital Costs</b>	<b>\$127,956,000</b>	
Engineering, Contingencies, and Legal Costs	\$38,810,000	
Land Acquisition	1,630,000	
Environmental Studies and Mitigation	1,678,000	
Interest During Construction	<u>8,164,000</u>	
<b>Total Project Costs</b>	<b>\$178,238,000</b>	
<b>Annual Costs</b>		
Annual Debt Service	\$16,754,000	\$16,754,000
Annual Operation and Maintenance	2,243,000	2,243,000
Annual Power Costs	<u>11,438,000</u>	<u>9,357,000</u>
<b>Total Annual Costs</b>	<b>\$30,435,000</b>	<b>\$28,354,000</b>
Increase in "Sustained Yield" (acft/yr)	87,000	87,000
Annual Cost of Increase in "Sustained Yield"	\$350/acft	\$326/acft
Average Annual Recirculated Recharge <sup>(3)</sup> (acft/yr)	116,600	95,900
Annual Cost of Recirculated Recharge	\$261/acft	\$296/acft
Notes:		
(1) "Sustained Yield" is the maximum fixed annual pumpage from the Edwards Aquifer subject to which discharge at Comal springs remains above 60 cfs during the most severe drought on record.		
(2) Drought annual averages for 1947-56 historical period.		
(3) Recirculated recharge is springflow diverted below Comal Springs, delivered via transmission pipeline to northwestern Bexar County, and allowed to recharge the Edwards Aquifer.		

**Table 5.1-4**  
**Cost Estimate Summaries for "Sustained Yield"<sup>(1)</sup> Aquifer Pumpage**  
**with up to 400 cfs Diversions from Lake Dunlap and Gonzales and**  
**Recharge to Northwestern Bexar County and Northern Medina County**  
**(L-23B)**  
**(First Quarter 1996 Prices)**

Item	Average Annual Diversion to Recharge Zone	Drought <sup>(2)</sup> Annual Diversion to Recharge Zone
<b>Capital Costs</b>		
Transmission and Pumping	\$425,010,000	
Treatment Plant (for Gonzales water only)	30,121,000	
New Reservoirs	5,360,000	
<b>Total Capital Costs</b>	<b>\$460,491,000</b>	
Engineering, Contingencies, and Legal Costs	\$141,252,000	
Land Acquisition	3,558,000	
Environmental Studies and Mitigation	3,542,000	
Interest During Construction	29,224,000	
<b>Total Project Costs</b>	<b>\$638,067,000</b>	
<b>Annual Costs</b>		
Annual Debt Service	\$59,978,000	\$59,978,000
Annual Operation and Maintenance	13,434,000	13,434,000
Annual Power Costs	17,869,000	11,202,000
<b>Total Annual Costs</b>	<b>\$91,281,000</b>	<b>\$84,614,000</b>
Incremental Total Annual Cost Increase Above 200 cfs	\$60,846,000	\$56,260,000
Increase in "Sustained Yield" (acft/yr)	118,000	118,000
Annual Cost of Increase in "Sustained Yield"	\$774/acft	\$717/acft
Incremental Increase in "Sustained Yield" Above 200 cfs (acft/yr)	31,000	31,000
Incremental Annual Cost of Increase in "Sustained Yield" Above 200 cfs	\$1,963/acft	\$1,815/acft
Average Annual Recirculated Recharge <sup>(3)</sup> (acft/yr)	186,100	117,500
Annual Cost of Recirculated Recharge	\$490/acft	\$720/acft
Incremental Increase in Average Annual Recirculated Recharge Above 200 cfs (acft/yr)	69,500	21,600
Incremental Annual Cost of Recirculated Recharge Above 200 cfs	\$875/acft	\$2,605/acft

Notes:

- (1) "Sustained Yield" is the maximum fixed annual pumpage from the Edwards Aquifer subject to which discharge at Comal springs remains above 60 cfs during the most severe drought on record.
- (2) Drought annual averages for 1947-56 historical period.
- (3) Recirculated recharge is springflow diverted from the Guadalupe River at Lake Dunlap and near Gonzales, delivered via transmission pipelines to northwestern Bexar County and northern Medina County, and allowed to recharge the Edwards Aquifer.

(This page intentionally left blank.)

## 6.0 SUMMARY

A conceptual evaluation of springflow recirculation was performed for two management plans. These plans were evaluated with the GWSIM4 computer model of the Edwards Aquifer developed by the Texas Water Development Board. One of the plans established a fixed aquifer pumpage of 400,000 ac-ft/yr and the other established pumpage at "sustained yield" rates. For each plan, baseline model simulations were made with no springflow recirculation to determine how each plan affects springflows and water levels. Recirculation evaluations were made with up to 200 cfs diverted downstream of Comal Springs and recharged in northwestern Bexar County, and another test with up to 400 cfs diverted downstream of Comal Springs and San Marcos Springs and recharged to northwestern Bexar County and northern Medina County. Each model simulation used the 1934-89 historical pattern of recharge, including the critical drought of 1947-56 to evaluate aquifer water levels and springflows. For the diversion of up to 200 cfs, only Comal Spring flow in excess of 60 cfs was considered to be available for diversion. For the maximum 400 cfs diversion, the combined springflow from Comal Springs and San Marcos Springs in excess of 160 cfs was considered to be available. In addition to the occasional lack of available springflow in the Guadalupe River, a lack of additional aquifer storage in the target recharge areas occasionally limited the amount of recirculated water.

For the 400,000 ac-ft/yr management plan, averages of 98,400 and 162,800 ac-ft/yr was recirculated back to the aquifer for the 200 cfs and 400 cfs tests, respectively. This increases the recharge by 15 and 25 percent, respectively. Because pumpage was fixed, most of the recirculated water became enhanced springflow at Comal Springs. Model results showed that, during the critical drought, the duration of the flow below the 60 cfs level was 9.25 years for the baseline conditions with no recirculation. This declined to 2.75 years with up to 200 cfs recirculation, and to only one year with 400 cfs recirculation. For the three simulations, Comal Springs had 'no flow' conditions, with durations of 2.75, 0.50, and zero years, respectively. The average flow for the Guadalupe River in the immediate vicinity of Comal Springs and downstream of the diversion for the 1934-89 test period decreased by an average of 35 cfs for the 200 cfs recirculation rate and by 86 cfs for the 400 cfs recirculation rate. However, during the drought period of 1947-56, the flows increased an average of 9 cfs for each of the two tests. Considering the water levels in the J-17 index well in San Antonio, the minimum water levels

were 8.8 ft higher with the 200 cfs recirculation rate and 10.0 ft higher with the 400 cfs recirculation rate. This general rise in water levels decreased the amount of time that the San Antonio area was in the most severe stage of the drought management plan from 13.4 years with no recirculation to 3.2 years for 200 cfs recirculation and to 1.2 years with 400 cfs recirculation.

The springflow recirculation diversions were also evaluated with respect to their effects on the availability of water to satisfy surface water rights and Guadalupe Estuary fisheries harvests. Under the 400,000 ac-ft/yr management plan, the principal impacts are reductions in streamflow below the recirculation diversion sites. For example, for the Guadalupe River at Cuero and for the Saltwater Barrier there were decreases in median monthly streamflows for nearly all months under both recirculation rates. Compared to the baseline case of no recirculation, the decreases were generally on the order of 4,000 ac-ft/mo for the 200 cfs recirculation and about 8,000 ac-ft/mo for the 400 cfs recirculation.

For locations on the San Antonio River near Falls City and the San Marcos River near Luling the median monthly streamflows predominantly showed small increases as the recirculation rate was increased. These locations benefit from the increased springflows of San Antonio, San Pedro, and San Marcos Springs which result from increased Edwards Aquifer recharge and storage.

Generally, recirculation of Guadalupe River water under 400,000 ac-ft/yr management plan would have little effect on water rights. For example, the average simulated shortage for large water rights at the Saltwater Barrier would increase from 7,326 ac-ft/yr to only 7,345 ac-ft/yr and to only 8,081 ac-ft/yr for the 200 cfs and the 400 cfs recirculation tests, respectively. For the 1947-56 critical drought period springflow recirculation would actually improve the availability of water to satisfy downstream rights. Compared to the baseline, a recirculation rate of 200 cfs or 400 cfs would decrease the average water rights shortage by 1,019 ac-ft/yr or 1,422, respectively during the critical drought. The estimated firm yield of Canyon Lake would be essentially unaffected by either to 200 cfs or 400 cfs recirculation rates under the 400,000 ac-ft/yr management plan. The effects of recirculation on Guadalupe Estuary fisheries harvest are also quite small based on the seven commercial species considered.



For the "sustained yield" management plan, Edwards Aquifer pumpage was allowed at a rate that would not cause the monthly flow from Comal Springs to fall below the critical level of 60 cfs during the drought of record. Based on model simulations, pumpage would be 270,000 ac-ft/yr under baseline conditions with no recirculation, 357,000 ac-ft/yr for a recirculation rate of up to 200 cfs and 388,000 ac-ft/yr for a recirculation rate of up to 400 cfs. Averages of 116,600 ac-ft/yr and 186,100 ac-ft/yr were recirculated back to the aquifer for the 200 cfs and 400 cfs tests, respectively. This increased the total recharge by 18 and 29 percent, respectively. About 75 percent of the recirculated water for the 200 cfs recirculation and about 64 percent of the water recirculated for the 400 cfs recirculation was later pumped from the aquifer. Even with the increase in aquifer pumpage, the long-term average flow from Comal Springs increased by 33 cfs for the 200 cfs recirculation rate and by 38 cfs for the 400 cfs recirculation rate. In the immediate vicinity of the diversion sites on the Guadalupe River, the average flow for the 1934-89 test period decreased by 97 cfs for the 200 cfs recirculation rate and 220 cfs for the 400 cfs recirculation rate. However, during the drought period of 1947-56, the flow decrease was considerably less than the 56-year average. Considering the water levels in the J-17 index well in San Antonio, the minimum water levels were 4.5 ft lower with the 200 cfs recirculation rate and 5.2 ft lower with the 400 cfs recirculation rate due to the increased pumpage. This general lowering of water levels would slightly increase the amount of time that the San Antonio area was in the most severe stage of the drought management plan from one or two months with no recirculation to six months for 200 cfs and 400 cfs recirculation rates.

The principal impacts of the "sustained yield" management plan include reductions in streamflow below the diversion sites. At the Saltwater Barrier, there were decreases in monthly median streamflows for nearly all months under both recirculation rates. The decreases were generally on the order of 6,000 ac-ft/mo for the 200 cfs recirculation and about 14,000 ac-ft/mo for the 400 cfs recirculation when compared to the baseline case of no recirculation. For locations on the San Antonio River near Falls City and the San Marcos River near Luling there were essentially no effects on median monthly streamflows as the recirculation rate was increased.

The recirculation of springflows under the "sustained yield" pumpage management plan has some effects on the large water rights near the Saltwater Barrier. The simulated average

shortage at the Saltwater Barrier would increase from 4,862 ac-ft/yr to 7,092 ac-ft/yr and to 8,054 ac-ft/yr for the 200 cfs and 400 cfs recirculation tests, respectively. For the 1947-56 critical drought period springflow recirculation would increase the average water rights shortage by 4,901 ac-ft/yr during the critical drought and by 5,225 ac-ft/yr with 400 cfs recirculation if not mitigated. These additional shortages can, in part, be eliminated by reducing the diversion rate of the pumping stations when downstream water rights shortages are imminent. The firm yield of Canyon Lake could decrease by 632 ac-ft/yr under the 200 cfs recirculation test and decrease by 871 ac-ft/yr with the 400 cfs recirculation. The simulated effects of the recirculation under the "sustained yield" pumpage management plan on the fisheries harvest of the Guadalupe Estuary are quite small with variable effects on seven commercial species.

For the management plan with a "sustained yield" pumpage and a simulated recirculation rate of 200 cfs, Edwards Aquifer pumpage is increased by about 87,000 ac-ft/yr. This increased pumpage would be at a unit cost of \$350 per ac-ft under long-term average conditions. During drought conditions when less water is recharged and power costs are reduced, the unit cost decreases to \$326 per ac-ft. For the option with a recirculative rate of up to 400 cfs, the "sustained yield" pumpage is increased by 118,000 ac-ft/yr. For this option, the long-term average unit cost is \$774 per ac-ft. During drought conditions, unit cost is reduced to \$717 per ac-ft as pumping costs are reduced. The incremental unit cost for the extra 31,000 ac-ft/yr of pumpage provided by the 400 cfs option is not economical as it ranges between \$1,963 and \$1,815 per ac-ft.

## 7.0 CONCLUSIONS AND RECOMMENDATIONS

The conceptual evaluation of Edwards Aquifer springflow recirculation indicates that implementation of this concept may offer a substantial opportunity for ensuring maintenance of springflows and for increasing the availability of ground water for water supply purposes during sustained droughts. Under the “sustained yield” scenario, springflow recirculation has been examined in a manner analogous to conventional surface water projects in that a firm, dependable increase in aquifer pumpage has been estimated which is subject to maintenance of a specified minimum component of Comal springflow (60 cfs) remaining in the river downstream of the diversion. Maintenance of springflows during drought conditions is a requirement by year 2012 under Senate Bill 1477, 1993 Texas Legislature.

Results of the “sustained yield” evaluation indicate that fixed annual pumpage could be increased by 87,000 ac-ft/yr based on facilities capable of diversion and transmission of up to 200 cfs of springflow from Dunlap Lake to the Edwards Aquifer recharge zone in northwestern Bexar County. The long-term average unit cost for this plan is \$350/ac-ft/yr. Simulated impacts of springflow recirculation on downstream water rights are relatively small and potentially avoidable on a real-time basis by temporarily halting recirculation diversions during critical shortages. Results of a second “substantial yield” evaluation in which up to an additional 200 cfs was recirculated from facilities located near Gonzales and recharged in Medina County, indicate that an additional 31,000 ac-ft/yr of aquifer pumpage could be sustained. However, the additional facilities needed to transport the water the extra distance results in unit cost of about \$2,000 per ac-ft/yr for this additional water.

It is important to note that the “sustained yield” Edwards Aquifer pumpage under either recirculation scenario is still less than 400,000 ac-ft/yr. Hence, springflow recirculation will most likely be considered as one component of several water management strategies that are expected to be based on the conjunctive use of surface and ground water supply sources. For example, operation of springflow recirculation diversion and transmission facilities in conjunction with conventional delivery, treatment and distribution of water from the Guadalupe River to Bexar County could provide significant economies of scale. Additionally, springflow recirculation should be further evaluated in conjunction with proposed recharge enhancement dams to determine the combined benefits and unit costs when operated as a system.

To more fully evaluate the potential benefits of springflow recirculation, it is recommended that the current version of GWSIM4 be improved to more accurately evaluate potential and recommended springflow recirculation and recharge enhancement projects. These improvements should include: (1) the ability to easily modify starting head conditions within the model, (2) a reevaluation of the head-discharge relationships at each spring, especially at San Antonio, San Pedro, and Leona Springs, (3) a consideration of discharge from Hueco Springs and any recharge from the Guadalupe River, and (4) a consideration of recharge coming from Onion Creek which may improve simulations at San Marcos Springs. These improvements are not intended to eliminate the need for a new generation ground water model of the aquifer system in the San Antonio area.

After GWSIM4 is improved, it is recommended that the following analysis be performed to fully evaluate the benefits of the recharge enhancement projects on the basis of "sustained yields" and unit cost of increased "sustained yields" both with and without springflow recirculation.

- Use GWSIM4 to determine in a systematic manner "sustained yield" pumpage and associated unit costs for individual or groups of recommended recharge projects. This would be done initially without recirculation;
- Use GWSIM4 to determine optimum recirculation rate from Lake Dunlap with recommended recharge projects in place and determine "sustained yield" and unit costs for a range of recirculation rates. Consider adding other water sources, i.e., unappropriated water, unutilized water rights, or purchased water rights at Lake Dunlap. Also, consider the water supply benefits and costs of extending the recirculation pipeline to Medina Lake on both aquifer yield and reservoir yield. (Note: This analysis is intended to determine the upper limit of aquifer pumpage for the combined effects of multiple recharge projects and water sources.)
- Determine optimum combination of recharge projects and recirculation rate by a systematic elimination of selected recharge projects to determine increased "sustained yield" and unit costs with recirculation in place; and
- Recommend optimum system and consider institutional and permitting issues associated with implementation to allow for pumping and springflow benefits to be fully realized.

**APPENDIX A**  
**GUADALUPE ESTUARY DATA**

TRANS-TEXAS WATER PROGRAM, WEST CENTRAL STUDY AREA, PHASE 2  
 HDR JOB# = 07755-026-036 DATE = 2/19/98  
 SCENARIO: TASK1 EDWARDS PUMPAGE @ 400,000 AC-Ft/YR, NO RECIRCULATION.

FRESHWATER INFLOWS (ACFT) - GUADALUPE ESTUARY  
 \*\*\*\*\*

MONTH	AVERAGE	10%<	25%<	50%<	75%<	90%<
*****	*****	****	****	****	****	****
JAN	122610.	11971.	46832.	78627.	131719.	242787.
FEB	130352.	23421.	47209.	90372.	147640.	265961.
MAR	108462.	16081.	39206.	77093.	164142.	234519.
APR	143625.	12002.	31356.	63311.	157845.	439136.
MAY	231556.	22215.	36978.	123888.	347480.	568113.
JUN	224265.	92.	30326.	93173.	256220.	490598.
JUL	119278.	0.	4286.	36658.	135128.	298219.
AUG	56872.	0.	5620.	33720.	74088.	137147.
SEP	173764.	1857.	20651.	70411.	187287.	411799.
OCT	163974.	9777.	27332.	82673.	146490.	358542.
NOV	129219.	13140.	40008.	74700.	163394.	291026.
DEC	116226.	15149.	41227.	74899.	146180.	246523.

UPPER SAN ANTONIO BAY SALINITY (PPT)  
 \*\*\*\*\*

MONTH	AVERAGE	10%<	25%<	50%<	75%<	90%<	#V SUB	#V SLB
*****	*****	****	****	****	****	****	*****	*****
JAN	13.30	2.43	7.46	12.73	16.80	22.44	11	10
FEB	12.31	1.87	7.89	11.86	16.74	19.20	6	11
MAR	13.70	4.24	6.80	12.82	17.53	23.03	12	8
APR	14.42	.00	7.48	14.59	20.04	26.73	15	11
MAY	10.75	.00	.70	9.24	18.74	22.78	17	14
JUN	14.17	.00	2.68	11.00	19.47	36.22	20	9
JUL	21.85	.90	8.18	18.42	32.76	45.00	36	5
AUG	22.59	6.45	12.69	19.37	30.42	45.00	37	0
SEP	16.05	.00	4.61	13.21	22.12	34.08	15	14
OCT	13.77	.18	4.15	12.55	20.70	23.78	16	14
NOV	13.63	1.22	7.14	13.30	17.32	26.68	10	9
DEC	13.82	2.81	8.10	12.97	17.97	21.81	12	7

LOWER SAN ANTONIO BAY SALINITY (PPT)  
 \*\*\*\*\*

MONTH	AVERAGE	10%<	25%<	50%<	75%<	90%<	#V SUB	#V SLB
*****	*****	****	****	****	****	****	*****	*****
JAN	22.24	12.22	16.90	21.80	25.59	30.84	16	0
FEB	21.32	11.70	17.30	20.99	25.53	27.82	17	0
MAR	22.60	13.90	16.28	21.88	26.27	31.38	16	0
APR	23.06	9.38	16.92	23.53	28.60	34.83	23	1
MAY	19.23	7.05	10.60	18.55	27.39	31.16	17	2
JUN	21.86	8.33	12.45	20.19	28.07	43.66	17	2
JUL	28.44	10.79	17.56	27.09	40.44	45.00	35	2
AUG	29.99	15.95	21.76	27.98	38.27	45.00	35	0
SEP	23.94	9.20	14.24	22.25	30.54	41.67	25	1
OCT	22.35	10.12	13.81	21.64	29.22	32.09	19	2
NOV	22.40	11.09	16.60	22.34	26.07	34.78	19	0
DEC	22.73	12.57	17.49	22.02	26.68	30.25	21	0

TRANS-TEXAS WATER PROGRAM, WEST CENTRAL STUDY AREA, PHASE 2  
 HDR JOB# = 07755-026-036 DATE = 2/19/98  
 SCENARIO: TASK1 EDWARDS PUMPAGE @ 400,000 AC-FYR, NO RECIRCULATION.

ESPIRITU SANTO BAY SALINITY (PPT)  
 \*\*\*\*\*

MONTH	AVERAGE	10%<	25%<	50%<	75%<	90%<	#V SUB	#V SLB
*****	*****	****	****	****	****	****	*****	*****
JAN	27.32	22.56	24.78	27.10	28.90	31.38	0	0
FEB	26.87	22.31	24.96	26.72	28.87	29.95	0	0
MAR	27.53	23.35	24.48	27.14	29.22	31.64	1	0
APR	27.82	21.21	24.78	27.92	30.32	33.28	1	0
MAY	26.02	20.11	21.79	25.56	29.75	31.54	1	0
JUN	27.84	20.71	22.67	26.33	30.07	37.46	6	0
JUL	31.83	21.88	25.09	29.61	35.94	45.00	13	0
AUG	31.97	24.33	27.08	30.03	34.91	45.00	8	0
SEP	28.64	21.13	23.52	27.31	31.24	36.52	5	0
OCT	27.39	21.56	23.31	27.02	30.61	31.98	0	0
NOV	27.51	22.02	24.63	27.35	29.12	33.26	1	0
DEC	27.54	22.72	25.06	27.21	29.41	31.10	0	0

ANNUAL NUTRIENT AND SEDIMENT CONSTRAINTS  
 \*\*\*\*\*

SIMULATED FRESHWATER INFLOWS LESS THAN NUTRIENT CONSTRAINT ( 860000. ACFT/YR) IN 14 YEARS  
 SIMULATED FRESHWATER INFLOWS LESS THAN SEDIMENT CONSTRAINT ( 355235. ACFT/YR) IN 5 YEARS

ANNUAL FISHERIES HARVEST (KLBS) - GUADALUPE ESTUARY  
 \*\*\*\*\*

SPECIES	AVERAGE	10%<	25%<	50%<	75%<	90%<	# YRS
*****	*****	****	****	****	****	****	*****
WHITE SHRIMP	819.	369.	612.	802.	1003.	1111.	38
BROWN SHRIMP	396.	73.	142.	307.	583.	700.	46
BLUE CRAB	211.	41.	44.	149.	255.	499.	46
OYSTER	478.	54.	54.	396.	619.	1039.	42
BLACK DRUM	26.	0.	5.	16.	40.	57.	45
RED DRUM	73.	31.	42.	56.	89.	123.	42
SEATROUT	57.	19.	27.	42.	77.	115.	49
TOTAL	2013.	1386.	1511.	1732.	2343.	3022.	30

TRANS-TEXAS WATER PROGRAM, WEST CENTRAL STUDY AREA, PHASE 2  
 HDR JOB# = 07755-026-036 DATE = 2/19/98  
 SCENARIO: TASK2A EDWARDS PUMPAGE @ 400,000 AC-FT/YR, RECIR. <= 200 CFS

FRESHWATER INFLOWS (ACFT) - GUADALUPE ESTUARY  
 \*\*\*\*\*

MONTH	AVERAGE	10%<	25%<	50%<	75%<	90%<
*****	*****	****	****	****	****	****
JAN	120300.	12438.	43218.	77159.	126952.	249632.
FEB	127786.	21131.	44285.	85677.	143280.	269916.
MAR	105990.	16614.	34334.	75868.	160482.	229612.
APR	141335.	9559.	28052.	59190.	153646.	433724.
MAY	229249.	20069.	32730.	118020.	342265.	560791.
JUN	222195.	92.	24668.	97038.	250134.	485179.
JUL	117662.	0.	1335.	34700.	131136.	293799.
AUG	55502.	0.	5217.	31798.	70870.	132883.
SEP	172440.	1132.	18921.	66805.	189175.	410623.
OCT	162473.	11432.	23657.	77579.	152752.	364211.
NOV	127414.	11054.	38752.	70645.	155708.	298320.
DEC	114320.	12896.	40628.	69599.	141746.	242419.

UPPER SAN ANTONIO BAY SALINITY (PPT)  
 \*\*\*\*\*

MONTH	AVERAGE	10%<	25%<	50%<	75%<	90%<	#V SUB	#V SLB
*****	*****	****	****	****	****	****	*****	*****
JAN	13.49	2.47	7.64	13.05	17.15	22.72	11	10
FEB	12.54	1.95	7.54	12.30	17.44	19.75	6	11
MAR	13.91	4.43	7.24	13.18	18.50	23.72	13	7
APR	14.80	.00	7.69	15.20	20.83	27.16	16	11
MAY	10.94	.00	.81	9.45	18.57	23.29	17	14
JUN	14.57	.00	2.81	11.22	18.66	40.57	20	9
JUL	22.58	.76	8.38	19.00	41.06	45.00	36	5
AUG	23.33	6.21	12.81	19.54	33.42	45.00	37	0
SEP	16.51	.00	4.75	13.38	22.79	37.54	17	14
OCT	13.96	.19	4.27	12.95	21.69	25.44	16	14
NOV	13.86	1.24	7.35	13.72	18.05	26.35	10	9
DEC	14.01	2.92	8.38	13.19	18.13	22.47	12	7

LOWER SAN ANTONIO BAY SALINITY (PPT)  
 \*\*\*\*\*

MONTH	AVERAGE	10%<	25%<	50%<	75%<	90%<	#V SUB	#V SLB
*****	*****	****	****	****	****	****	*****	*****
JAN	22.43	12.26	17.06	22.10	25.91	31.09	16	0
FEB	21.54	11.76	16.97	21.40	26.19	28.33	17	0
MAR	22.86	14.07	16.69	22.22	27.17	32.03	17	0
APR	23.41	9.30	17.11	24.10	29.34	35.23	25	1
MAY	19.46	7.02	10.70	18.75	27.24	31.63	17	2
JUN	22.19	8.39	12.57	20.40	27.32	45.00	18	2
JUL	28.94	10.67	17.75	27.64	45.00	45.00	35	2
AUG	30.54	15.74	21.88	28.14	41.06	45.00	34	0
SEP	24.29	9.33	14.37	22.41	31.16	44.89	25	1
OCT	22.58	10.13	13.92	22.01	30.14	33.63	20	2
NOV	22.62	11.11	16.79	22.73	26.75	34.48	18	0
DEC	22.89	12.67	17.75	22.23	26.83	30.86	22	0



TRANS-TEXAS WATER PROGRAM, WEST CENTRAL STUDY AREA, PHASE 2  
 HDR JOB# = 07755-026-036 DATE = 2/19/98  
 SCENARIO: TASK2A EDWARDS PUMPAGE @ 400,000 AC-FT/YR,RECIR. <= 200 CFS

ESPIRITU SANTO BAY SALINITY (PPT)  
 \*\*\*\*\*

MONTH	AVERAGE	10%<	25%<	50%<	75%<	90%<	#V SUB	#V SLB
*****	*****	****	****	****	****	****	*****	*****
JAN	27.40	22.57	24.85	27.24	29.05	31.51	0	0
FEB	26.98	22.34	24.81	26.91	29.18	30.19	0	0
MAR	27.62	23.44	24.68	27.30	29.65	31.95	0	0
APR	27.99	21.17	24.88	28.19	30.67	33.46	1	0
MAY	26.11	20.09	21.84	25.65	29.68	31.76	1	0
JUN	28.02	20.74	22.72	26.43	29.71	39.38	6	0
JUL	32.09	21.82	25.18	29.87	39.60	45.00	14	0
AUG	32.31	24.22	27.14	30.11	36.23	45.00	9	0
SEP	28.86	21.19	23.58	27.39	31.54	38.05	6	0
OCT	27.48	21.57	23.37	27.20	31.05	32.71	0	0
NOV	27.61	22.03	24.72	27.54	29.45	33.11	1	0
DEC	27.62	22.77	25.18	27.30	29.48	31.40	0	0

ANNUAL NUTRIENT AND SEDIMENT CONSTRAINTS  
 \*\*\*\*\*

SIMULATED FRESHWATER INFLOWS LESS THAN NUTRIENT CONSTRAINT ( 860000. ACFT/YR) IN 15 YEARS  
 SIMULATED FRESHWATER INFLOWS LESS THAN SEDIMENT CONSTRAINT ( 355235. ACFT/YR) IN 7 YEARS

ANNUAL FISHERIES HARVEST (KLBS) - GUADALUPE ESTUARY  
 \*\*\*\*\*

SPECIES	AVERAGE	10%<	25%<	50%<	75%<	90%<	# YRS
*****	*****	****	****	****	****	****	*****
WHITE SHRIMP	822.	420.	609.	806.	1007.	1110.	38
BROWN SHRIMP	394.	67.	136.	313.	556.	684.	46
BLUE CRAB	209.	41.	41.	151.	255.	505.	46
OYSTER	477.	54.	54.	351.	638.	1052.	42
BLACK DRUM	25.	0.	4.	16.	41.	58.	45
RED DRUM	72.	31.	41.	56.	87.	124.	42
SEATROUT	57.	19.	27.	44.	78.	115.	49
*****	*****	*****	*****	*****	*****	*****	*****
TOTAL	2007.	1382.	1511.	1723.	2343.	2979.	30

TRANS-TEXAS WATER PROGRAM, WEST CENTRAL STUDY AREA, PHASE 2  
 HDR JOB# = 07755-026-036 DATE = 2/19/98  
 SCENARIO: TASK2B EDWARDS PUMPAGE @ 400,000 AC-FT/YR, RECIR. <= 400 CFS

FRESHWATER INFLOWS (ACFT) - GUADALUPE ESTUARY  
 \*\*\*\*\*

MONTH	AVERAGE	10%<	25%<	50%<	75%<	90%<
*****	*****	****	****	****	****	****
JAN	116908.	11599.	39044.	74152.	124369.	241019.
FEB	124012.	23298.	41180.	78574.	138032.	261502.
MAR	101759.	16376.	30113.	71405.	153806.	225479.
APR	137588.	8909.	23012.	57694.	144176.	424513.
MAY	225459.	18714.	30773.	114176.	339969.	559474.
JUN	218720.	92.	19659.	89152.	244985.	480624.
JUL	114629.	0.	1003.	32538.	126443.	282888.
AUG	52654.	0.	4454.	30086.	68649.	122843.
SEP	169596.	357.	17831.	67065.	185909.	409634.
OCT	159546.	11240.	21919.	73571.	144891.	355340.
NOV	124539.	10749.	35994.	66017.	154766.	290668.
DEC	111312.	12033.	36981.	67761.	138966.	237131.

UPPER SAN ANTONIO BAY SALINITY (PPT)  
 \*\*\*\*\*

MONTH	AVERAGE	10%<	25%<	50%<	75%<	90%<	#V SUB	#V SLB
*****	*****	****	****	****	****	****	*****	*****
JAN	13.67	2.70	8.07	13.07	17.59	22.93	11	9
FEB	12.83	2.18	7.94	12.77	17.66	20.56	7	11
MAR	14.22	4.54	7.68	13.48	19.80	23.90	14	7
APR	15.24	.00	7.79	15.22	22.12	27.93	16	11
MAY	11.38	.00	1.05	9.94	18.48	23.55	18	13
JUN	15.09	.00	2.91	11.51	18.30	45.00	22	9
JUL	23.23	.71	8.52	19.77	41.20	45.00	36	5
AUG	24.00	6.30	13.01	20.10	35.30	45.00	39	0
SEP	16.95	.00	4.83	14.13	23.24	37.84	20	14
OCT	14.27	.23	4.29	13.29	22.78	24.79	16	14
NOV	14.04	1.31	7.43	14.07	18.78	26.39	12	9
DEC	14.27	3.14	8.49	13.35	18.89	23.05	12	7

LOWER SAN ANTONIO BAY SALINITY (PPT)  
 \*\*\*\*\*

MONTH	AVERAGE	10%<	25%<	50%<	75%<	90%<	#V SUB	#V SLB
*****	*****	****	****	****	****	****	*****	*****
JAN	22.60	12.47	17.46	22.12	26.32	31.29	19	0
FEB	21.81	11.98	17.34	21.84	26.39	29.09	18	0
MAR	23.19	14.18	17.10	22.50	28.38	32.20	19	0
APR	23.83	9.43	17.20	24.12	30.53	35.95	25	1
MAY	19.76	7.02	10.93	19.20	27.15	31.87	17	2
JUN	22.49	8.43	12.66	20.66	26.98	45.00	19	2
JUL	29.51	10.61	17.88	28.35	45.00	45.00	35	2
AUG	31.12	15.82	22.06	28.66	42.80	45.00	37	0
SEP	24.71	9.36	14.44	23.10	31.58	45.00	25	1
OCT	22.86	10.16	13.95	22.32	31.15	33.02	22	2
NOV	22.85	11.18	16.87	23.04	27.43	34.51	20	0
DEC	23.14	12.88	17.85	22.37	27.54	31.41	22	0

TRANS-TEXAS WATER PROGRAM, WEST CENTRAL STUDY AREA, PHASE 2  
 HDR JOB# = 07755-026-036                      DATE = 2/19/98  
 SCENARIO: TASK2B EDWARDS PUMPAGE @ 400,000 AC-FT/YR,RECIR. <= 400 CFS

ESPIRITU SANTO BAY SALINITY (PPT)  
 \*\*\*\*\*

MONTH	AVERAGE	10%<	25%<	50%<	75%<	90%<	#V SUB	#V SLB
*****	*****	****	****	****	****	****	*****	*****
JAN	27.48	22.68	25.04	27.25	29.24	31.60	0	0
FEB	27.11	22.44	24.99	27.12	29.27	30.55	0	0
MAR	27.76	23.49	24.87	27.43	30.22	32.03	0	0
APR	28.19	21.23	24.92	28.20	31.24	33.81	1	0
MAY	26.38	20.09	21.95	25.87	29.63	31.87	2	0
JUN	28.38	20.76	22.77	26.56	29.56	45.00	8	0
JUL	32.46	21.79	25.24	30.21	39.66	45.00	14	0
AUG	32.61	24.26	27.22	30.35	37.06	45.00	9	0
SEP	29.12	21.20	23.61	27.72	31.74	38.18	6	0
OCT	27.62	21.58	23.38	27.35	31.53	32.42	0	0
NOV	27.62	22.06	24.76	27.69	29.77	33.13	0	0
DEC	27.73	22.87	25.23	27.37	29.82	31.65	0	0

ANNUAL NUTRIENT AND SEDIMENT CONSTRAINTS  
 \*\*\*\*\*

SIMULATED FRESHWATER INFLOWS LESS THAN NUTRIENT CONSTRAINT ( 860000. ACFT/YR) IN 16 YEARS  
 SIMULATED FRESHWATER INFLOWS LESS THAN SEDIMENT CONSTRAINT ( 355235. ACFT/YR) IN 7 YEARS

ANNUAL FISHERIES HARVEST (KLBS) - GUADALUPE ESTUARY  
 \*\*\*\*\*

SPECIES	AVERAGE	10%<	25%<	50%<	75%<	90%<	# YRS
*****	*****	****	****	****	****	****	*****
WHITE SHRIMP	820.	433.	604.	794.	985.	1110.	37
BROWN SHRIMP	391.	67.	137.	287.	538.	702.	46
BLUE CRAB	208.	41.	41.	151.	253.	513.	45
OYSTER	456.	54.	54.	272.	585.	1069.	41
BLACK DRUM	25.	0.	3.	15.	38.	55.	45
RED DRUM	72.	31.	40.	55.	88.	121.	41
SEATROUT	58.	19.	28.	44.	80.	115.	49
TOTAL	2002.	1113.	1436.	1703.	2343.	2920.	27

TRANS-TEXAS WATER PROGRAM, WEST CENTRAL STUDY AREA, PHASE 2  
 HDR JOB# = 07755-026-036 DATE = 2/19/98  
 SCENARIO: TASK3 SUSTAIN. YLD PUMPAGE =270000 AC-FT/YR,NO RECIRCULATION

FRESHWATER INFLOWS (ACFT) - GUADALUPE ESTUARY  
 \*\*\*\*\*

MONTH	AVERAGE	10%<	25%<	50%<	75%<	90%<
*****	*****	****	****	****	****	****
JAN	128358.	17120.	51732.	85619.	137796.	250865.
FEB	136054.	29216.	53356.	96589.	152956.	271859.
MAR	114003.	21083.	45050.	79791.	169911.	240627.
APR	149105.	17655.	35862.	69915.	163819.	443740.
MAY	237234.	27720.	42400.	129961.	353858.	571977.
JUN	229503.	92.	35996.	98749.	260621.	497203.
JUL	123991.	0.	6290.	42887.	141045.	303655.
AUG	61677.	0.	11241.	39881.	80721.	143117.
SEP	179225.	1857.	26694.	76984.	193953.	418624.
OCT	169830.	15232.	32982.	88788.	153145.	366041.
NOV	135130.	18131.	45943.	80948.	166210.	299024.
DEC	122058.	20390.	45646.	81241.	152524.	252881.

UPPER SAN ANTONIO BAY SALINITY (PPT)  
 \*\*\*\*\*

MONTH	AVERAGE	10%<	25%<	50%<	75%<	90%<	#V SUB	#V SLB
*****	*****	****	****	****	****	****	*****	*****
JAN	12.42	2.28	7.13	12.19	15.93	20.88	8	10
FEB	11.62	1.69	7.52	11.31	15.96	17.97	6	11
MAR	12.75	4.04	6.70	12.28	16.49	21.19	10	9
APR	13.50	.00	7.24	13.91	18.63	23.97	12	12
MAY	9.89	.00	.60	8.85	17.82	21.01	17	14
JUN	13.52	.00	2.52	10.53	18.15	29.03	18	9
JUL	20.24	.73	7.84	17.50	29.23	45.00	35	5
AUG	21.26	6.12	12.11	18.06	26.15	45.00	36	0
SEP	14.99	.00	4.39	12.58	20.30	28.50	15	14
OCT	12.68	.05	3.93	12.00	19.78	21.94	11	14
NOV	12.69	1.07	6.84	12.75	16.50	24.12	9	9
DEC	12.89	2.63	7.78	12.44	17.06	20.12	7	7

LOWER SAN ANTONIO BAY SALINITY (PPT)  
 \*\*\*\*\*

MONTH	AVERAGE	10%<	25%<	50%<	75%<	90%<	#V SUB	#V SLB
*****	*****	****	****	****	****	****	*****	*****
JAN	21.43	12.07	16.59	21.30	24.78	29.38	14	0
FEB	20.68	11.53	16.95	20.48	24.81	26.68	12	0
MAR	21.82	13.71	16.19	21.38	25.30	29.67	15	0
APR	22.19	9.27	16.69	22.90	27.29	32.26	20	1
MAY	18.57	6.96	10.51	18.19	26.54	29.51	17	2
JUN	21.24	8.24	12.30	19.75	26.84	36.97	15	2
JUL	27.48	10.63	17.25	26.24	37.16	45.00	31	2
AUG	28.77	15.65	21.22	26.76	34.29	45.00	32	0
SEP	22.98	9.13	14.04	21.66	28.84	36.48	23	1
OCT	21.40	10.00	13.61	21.12	28.36	30.37	18	2
NOV	21.62	10.95	16.32	21.82	25.31	32.40	16	0
DEC	21.85	12.40	17.19	21.53	25.83	28.68	18	0

TRANS-TEXAS WATER PROGRAM, WEST CENTRAL STUDY AREA, PHASE 2  
 HDR JOB# = 07755-026-036 DATE = 2/19/98  
 SCENARIO: TASK3 SUSTAIN. YLD PUMPAGE =270000 AC-FT/YR,NO RECIRCULATION

ESPIRITU SANTO BAY SALINITY (PPT)

\*\*\*\*\*

MONTH	AVERAGE	10%<	25%<	50%<	75%<	90%<	#V SUB	#V SLB
*****	*****	****	****	****	****	****	*****	*****
JAN	26.92	22.49	24.63	26.86	28.51	30.69	0	0
FEB	26.57	22.23	24.80	26.47	28.52	29.41	0	0
MAR	27.11	23.26	24.44	26.90	28.76	30.83	0	0
APR	27.38	21.16	24.68	27.62	29.70	32.06	1	0
MAY	25.57	20.07	21.75	25.39	29.35	30.75	0	0
JUN	27.55	20.67	22.59	26.13	29.49	34.29	6	0
JUL	30.79	21.80	24.94	29.20	34.38	45.00	8	0
AUG	31.39	24.18	26.82	29.45	33.02	45.00	8	0
SEP	28.17	21.09	23.42	27.03	30.44	34.06	5	0
OCT	26.91	21.50	23.22	26.78	30.21	31.16	0	0
NOV	27.03	21.95	24.50	27.11	28.76	32.13	0	0
DEC	27.12	22.64	24.92	26.97	29.01	30.36	0	0

ANNUAL NUTRIENT AND SEDIMENT CONSTRAINTS

\*\*\*\*\*

SIMULATED FRESHWATER INFLOWS LESS THAN NUTRIENT CONSTRAINT ( 860000. ACFT/YR) IN 14 YEARS  
 SIMULATED FRESHWATER INFLOWS LESS THAN SEDIMENT CONSTRAINT ( 355235. ACFT/YR) IN 4 YEARS

ANNUAL FISHERIES HARVEST (KLBS) - GUADALUPE ESTUARY

\*\*\*\*\*

SPECIES	AVERAGE	10%<	25%<	50%<	75%<	90%<	# YRS
*****	*****	****	****	****	****	****	*****
WHITE SHRIMP	803.	449.	614.	774.	982.	1099.	40
BROWN SHRIMP	391.	83.	145.	267.	514.	675.	49
BLUE CRAB	219.	41.	61.	155.	260.	492.	46
OYSTER	489.	54.	54.	416.	672.	1037.	43
BLACK DRUM	27.	0.	7.	18.	42.	59.	46
RED DRUM	74.	32.	41.	58.	90.	125.	42
SEATROUT	57.	19.	27.	42.	76.	115.	49
*****							
TOTAL	2055.	1399.	1597.	1882.	2369.	2897.	32

TRANS-TEXAS WATER PROGRAM, WEST CENTRAL STUDY AREA, PHASE 2  
 HDR JOB# = 07755-026-036 DATE = 2/19/98  
 SCENARIO: TASK4A SUSTAIN. YIELD PUMPAGE =357000 AC-FT/YR,RECIR. <= 200

FRESHWATER INFLOWS (ACFT) - GUADALUPE ESTUARY

\*\*\*\*\*

MONTH	AVERAGE	10%<	25%<	50%<	75%<	90%<
*****	*****	****	****	****	****	****
JAN	122506.	12328.	45947.	78561.	131785.	252552.
FEB	130028.	23960.	46078.	88253.	145905.	271930.
MAR	107867.	16510.	36728.	77899.	162863.	234424.
APR	143251.	12006.	29059.	61004.	156455.	435540.
MAY	230688.	21025.	34073.	121362.	343192.	562133.
JUN	223666.	92.	26744.	100634.	251621.	489794.
JUL	119039.	0.	2600.	38320.	133022.	296204.
AUG	56752.	0.	5249.	33242.	73648.	134915.
SEP	173833.	1857.	18775.	76808.	189068.	411222.
OCT	163831.	11332.	25556.	79804.	145832.	364635.
NOV	129306.	11195.	39164.	73675.	158764.	302681.
DEC	116276.	13226.	41902.	72549.	144432.	246576.

UPPER SAN ANTONIO BAY SALINITY (PPT)

\*\*\*\*\*

MONTH	AVERAGE	10%<	25%<	50%<	75%<	90%<	#V SUB	#V SLB
*****	*****	****	****	****	****	****	*****	*****
JAN	13.21	2.44	7.48	12.76	16.94	22.54	11	10
FEB	12.31	1.87	7.36	11.90	17.01	19.21	6	11
MAR	13.66	4.31	7.21	12.95	18.02	23.03	13	8
APR	14.53	.00	7.59	14.84	20.41	26.99	15	11
MAY	10.83	.00	.77	9.23	19.49	22.96	17	14
JUN	14.41	.00	2.70	11.05	20.32	37.21	20	9
JUL	22.08	.71	8.31	18.61	37.96	45.00	36	5
AUG	22.88	6.10	12.83	19.59	31.27	45.00	37	0
SEP	16.23	.00	4.73	13.03	22.27	37.75	16	14
OCT	13.80	.19	4.20	12.74	21.21	24.36	16	14
NOV	13.64	1.24	7.21	13.42	17.70	26.41	10	9
DEC	13.77	2.83	8.18	13.14	17.79	22.51	12	7

LOWER SAN ANTONIO BAY SALINITY (PPT)

\*\*\*\*\*

MONTH	AVERAGE	10%<	25%<	50%<	75%<	90%<	#V SUB	#V SLB
*****	*****	****	****	****	****	****	*****	*****
JAN	22.17	12.22	16.91	21.82	25.72	30.93	16	0
FEB	21.33	11.69	16.80	21.03	25.78	27.84	17	0
MAR	22.67	13.97	16.66	22.01	26.72	31.39	16	0
APR	23.15	9.42	17.02	23.77	28.95	35.07	23	1
MAY	19.34	7.01	10.67	18.55	28.09	31.32	17	2
JUN	22.08	8.36	12.47	20.23	28.87	44.58	18	2
JUL	28.68	10.62	17.68	27.27	45.00	45.00	35	2
AUG	30.20	15.64	21.89	28.18	39.06	45.00	33	0
SEP	24.13	9.29	14.36	22.08	30.68	45.00	25	1
OCT	22.42	10.13	13.86	21.81	29.70	32.63	18	2
NOV	22.41	11.11	16.66	22.45	26.43	34.53	18	0
DEC	22.67	12.59	17.57	22.18	26.51	30.91	22	0

TRANS-TEXAS WATER PROGRAM, WEST CENTRAL STUDY AREA, PHASE 2  
 HDR JOB# = 07755-026-036 DATE = 2/19/98  
 SCENARIO: TASK4A SUSTAIN. YIELD PUMPAGE =357000 AC-FT/YR,RECIR. <= 200

ESPIRITU SANTO BAY SALINITY (PPT)  
 \*\*\*\*\*

MONTH	AVERAGE	10%<	25%<	50%<	75%<	90%<	#V SUB	#V SLB
*****	*****	****	****	****	****	****	*****	*****
JAN	27.27	22.56	24.78	27.11	28.96	31.43	0	0
FEB	26.87	22.31	24.73	26.73	28.99	29.96	0	0
MAR	27.51	23.39	24.66	27.20	29.43	31.65	0	0
APR	27.86	21.23	24.83	28.03	30.49	33.39	1	0
MAY	26.06	20.09	21.82	25.56	30.08	31.61	1	0
JUN	27.95	20.73	22.68	26.36	30.45	37.90	6	0
JUL	31.84	21.80	25.15	29.69	38.23	45.00	12	0
AUG	32.10	24.18	27.14	30.13	35.28	45.00	8	0
SEP	28.73	21.17	23.57	27.23	31.31	38.14	5	0
OCT	27.40	21.57	23.34	27.10	30.84	32.23	0	0
NOV	27.44	22.03	24.66	27.41	29.29	33.14	1	0
DEC	27.51	22.73	25.09	27.28	29.33	31.42	0	0

ANNUAL NUTRIENT AND SEDIMENT CONSTRAINTS  
 \*\*\*\*\*

SIMULATED FRESHWATER INFLOWS LESS THAN NUTRIENT CONSTRAINT ( 860000. ACFT/YR) IN 15 YEARS  
 SIMULATED FRESHWATER INFLOWS LESS THAN SEDIMENT CONSTRAINT ( 355235. ACFT/YR) IN 6 YEARS

ANNUAL FISHERIES HARVEST (KLBS) - GUADALUPE ESTUARY  
 \*\*\*\*\*

SPECIES	AVERAGE	10%<	25%<	50%<	75%<	90%<	# YRS
*****	*****	****	****	****	****	****	*****
WHITE SHRIMP	818.	352.	609.	799.	1009.	1110.	38
BROWN SHRIMP	395.	67.	137.	320.	563.	649.	46
BLUE CRAB	210.	41.	50.	151.	257.	502.	46
OYSTER	478.	54.	54.	359.	635.	1044.	42
BLACK DRUM	26.	0.	5.	16.	41.	59.	45
RED DRUM	73.	31.	42.	56.	89.	125.	42
SEATROUT	57.	19.	27.	43.	77.	115.	49
TOTAL	2009.	1359.	1512.	1726.	2348.	2998.	30

TRANS-TEXAS WATER PROGRAM, WEST CENTRAL STUDY AREA, PHASE 2  
 HDR JOB# = 07755-026-036 DATE = 2/19/98  
 SCENARIO: TASK4B SUSTAIN. YLD PUMPAGE =388000 AC-FT/YR,RECIR. <= 400 CFS

FRESHWATER INFLOWS (ACFT) - GUADALUPE ESTUARY  
 \*\*\*\*\*

MONTH	AVERAGE	10%<	25%<	50%<	75%<	90%<
*****	*****	*****	*****	*****	*****	*****
JAN	116769.	11349.	39045.	70561.	125071.	242995.
FEB	123973.	23907.	41722.	79194.	138551.	263895.
MAR	101831.	16354.	31018.	70137.	153917.	226180.
APR	137112.	8543.	23490.	57588.	146059.	424617.
MAY	224706.	18620.	30731.	113889.	339547.	559410.
JUN	217946.	92.	19312.	90377.	244945.	480463.
JUL	114082.	0.	1003.	30800.	127134.	283617.
AUG	52411.	0.	3634.	29776.	68477.	123832.
SEP	169391.	357.	17474.	61428.	185615.	409403.
OCT	159119.	10956.	22183.	74243.	146496.	357619.
NOV	124497.	10671.	36031.	66118.	154979.	292241.
DEC	110949.	11927.	37249.	67471.	139109.	237779.

UPPER SAN ANTONIO BAY SALINITY (PPT)  
 \*\*\*\*\*

MONTH	AVERAGE	10%<	25%<	50%<	75%<	90%<	#V SUB	#V SLB
*****	*****	*****	*****	*****	*****	*****	*****	*****
JAN	13.68	2.70	8.02	13.48	17.46	22.95	11	9
FEB	12.85	2.13	7.86	12.75	17.63	20.38	7	11
MAR	14.24	4.53	7.63	13.77	19.66	24.03	14	7
APR	15.29	.00	7.80	15.26	21.83	27.97	16	11
MAY	11.41	.00	1.04	9.90	19.25	23.60	18	13
JUN	15.18	.00	2.91	11.52	19.97	45.00	22	9
JUL	23.52	.89	8.54	19.86	42.43	45.00	36	5
AUG	24.33	6.46	13.04	20.12	35.56	45.00	39	0
SEP	17.06	.00	4.84	14.15	23.34	38.20	19	14
OCT	14.34	.23	4.49	13.20	22.75	26.47	16	14
NOV	14.08	1.32	7.44	14.07	18.83	26.56	12	9
DEC	14.32	3.12	8.51	13.28	18.71	22.80	13	7

LOWER SAN ANTONIO BAY SALINITY (PPT)  
 \*\*\*\*\*

MONTH	AVERAGE	10%<	25%<	50%<	75%<	90%<	#V SUB	#V SLB
*****	*****	*****	*****	*****	*****	*****	*****	*****
JAN	22.61	12.46	17.42	22.49	26.20	31.31	19	0
FEB	21.83	11.94	17.27	21.82	26.36	28.92	19	0
MAR	23.21	14.17	17.06	22.77	28.25	32.31	19	0
APR	23.87	9.40	17.21	24.15	30.27	35.99	25	1
MAY	19.79	7.02	10.92	19.16	27.87	31.92	17	2
JUN	22.57	8.43	12.66	20.67	28.53	45.00	19	2
JUL	29.72	10.78	17.90	28.43	45.00	45.00	35	2
AUG	31.32	15.96	22.09	28.68	43.05	45.00	37	0
SEP	24.80	9.36	14.46	23.12	31.68	45.00	25	1
OCT	22.91	10.17	14.13	22.24	31.12	34.58	22	2
NOV	22.88	11.18	16.87	23.05	27.48	34.67	20	0
DEC	23.19	12.86	17.87	22.31	27.36	31.18	22	0



TRANS-TEXAS WATER PROGRAM, WEST CENTRAL STUDY AREA, PHASE 2  
 HDR JOB# = 07755-026-036 DATE = 2/19/98  
 SCENARIO: TASK4B SUSTAIN. YLD PUMPAGE =388000 AC-FT/YR,RECIR. <= 400 CFS

ESPIRITU SANTO BAY SALINITY (PPT)  
 \*\*\*\*\*

MONTH	AVERAGE	10%<	25%<	50%<	75%<	90%<	#V SUB	#V SLB
JAN	27.48	22.67	25.02	27.43	29.19	31.61	0	0
FEB	27.11	22.42	24.95	27.11	29.26	30.47	0	0
MAR	27.77	23.48	24.85	27.56	30.16	32.08	0	0
APR	28.21	21.22	24.93	28.21	31.11	33.82	1	0
MAY	26.39	20.09	21.94	25.85	29.97	31.90	2	0
JUN	28.42	20.76	22.77	26.56	30.29	45.00	8	0
JUL	32.54	21.88	25.25	30.24	40.20	45.00	15	0
AUG	32.75	24.33	27.24	30.36	37.17	45.00	11	0
SEP	29.16	21.20	23.62	27.73	31.78	38.34	6	0
OCT	27.65	21.59	23.46	27.31	31.52	33.16	0	0
NOV	27.64	22.07	24.76	27.69	29.79	33.20	0	0
DEC	27.76	22.86	25.24	27.34	29.74	31.54	0	0

ANNUAL NUTRIENT AND SEDIMENT CONSTRAINTS  
 \*\*\*\*\*

SIMULATED FRESHWATER INFLOWS LESS THAN NUTRIENT CONSTRAINT ( 860000. ACFT/YR) IN 16 YEARS  
 SIMULATED FRESHWATER INFLOWS LESS THAN SEDIMENT CONSTRAINT ( 355235. ACFT/YR) IN 7 YEARS

ANNUAL FISHERIES HARVEST (KLBS) - GUADALUPE ESTUARY  
 \*\*\*\*\*

SPECIES	AVERAGE	10%<	25%<	50%<	75%<	90%<	# YRS
WHITE SHRIMP	820.	409.	604.	800.	986.	1110.	37
BROWN SHRIMP	391.	67.	137.	286.	537.	695.	46
BLUE CRAB	208.	41.	41.	151.	253.	514.	45
OYSTER	456.	54.	54.	272.	595.	1069.	41
BLACK DRUM	25.	0.	3.	16.	39.	55.	45
RED DRUM	72.	29.	40.	55.	84.	121.	41
SEATROUT	57.	19.	27.	44.	79.	115.	49
TOTAL	2000.	1116.	1427.	1697.	2338.	2925.	27

**Report 3**

**Modification of Principal Spillways at  
Existing Flood Control Projects for  
Recharge Enhancement**

**TRANS-TEXAS WATER PROGRAM  
WEST CENTRAL STUDY AREA**

**PHASE 2**

**MODIFICATION OF PRINCIPAL SPILLWAYS AT  
EXISTING FLOOD CONTROL PROJECTS FOR  
RECHARGE ENHANCEMENT**

**San Antonio River Authority  
San Antonio Water System  
Edwards Aquifer Authority  
Guadalupe-Blanco River Authority  
Lower Colorado River Authority  
Bexar Metropolitan Water District  
Nueces River Authority  
Canyon Lake Water Supply Corporation  
Bexar-Medina-Atascosa Counties WCID No. 1  
Texas Natural Resource Conservation Commission  
Texas Parks and Wildlife Department  
Texas Water Development Board**

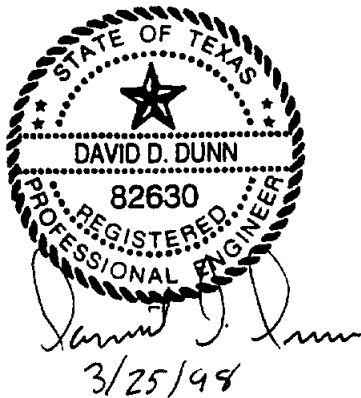

March 1998

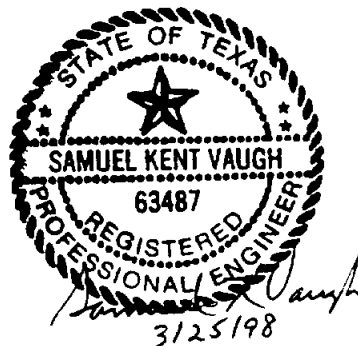

**MODIFICATION OF PRINCIPAL SPILLWAYS AT  
EXISTING FLOOD CONTROL PROJECTS FOR  
RECHARGE ENHANCEMENT**

**TABLE OF CONTENTS**

<b>Section</b>	<b>Page</b>
<b>1.0 INTRODUCTION.....</b>	<b>1-1</b>
<b>2.0 SITE SELECTION.....</b>	<b>2-1</b>
<b>3.0 FLOOD HYDROLOGY ANALYSIS .....</b>	<b>3-1</b>
<b>3.1 Data Collection and Model Development .....</b>	<b>3-1</b>
<b>3.2 Performance of Flood Retarding Structures Without Considering         Recharge .....</b>	<b>3-4</b>
<b>3.3 Performance of Flood Retarding Structures Considering Recharge.....</b>	<b>3-6</b>
<b>3.4 Evaluation of Principal Spillway Constriction.....</b>	<b>3-6</b>
<b>4.0 RECHARGE ENHANCEMENT POTENTIAL.....</b>	<b>4-1</b>
<b>5.0 IMPLEMENTATION .....</b>	<b>5-1</b>
<b>6.0 SUMMARY .....</b>	<b>6-1</b>

## LIST OF FIGURES

<b>Figure No.</b>		<b>Page</b>
2-1	Location Map, Potential Sites for FRS Outlet Modifications.....	2-4
3-1	Typical NRCS Flood Retardation Structure .....	3-3
3-2	Comal Site 4 Unconstricted Principal Spillway Ratings .....	3-8
3-3	Salado Site 11 Unconstricted and Constricted Principal Spillway Ratings.....	3-9
3-4	Salado Site 13A Unconstricted and Constricted Principal Spillway Ratings.....	3-10
3-5	Comal Site 4 Flood Pool Hydrograph.....	3-12
3-6	Salado Site 11 Flood Pool Hydrograph .....	3-13
3-7	Salado Site 13A Flood Pool Hydrograph.....	3-14

## LIST OF TABLES

<b>Table No.</b>		<b>Page</b>
2-1	Summary of NRCS Flood Control Structures on the Edwards Aquifer Recharge Zone .....	2-1
3-1	Summary of Principal Spillway and Flood Storage Parameters .....	3-4
3-2	Flood Hydrology Parameters, 100-Year Design Storm Event.....	3-5
3-3	Summary of Flood Structures Performance without Recharge Considered .....	3-5
3-4	Summary of Flood Structures Performance with Recharge Considered .....	3-7
3-5	Summary of Flood Structures Performance with Constricted Principal Spillways and Consideration of Recharge .....	3-11
4-1	Recharge Enhancement Potential, Single Storm Event Analysis, Salado Creek Site 11 .....	4-1
4-2	Summary of Recharge Enhancement for Salado Creek Site 11 and Site 13A.....	4-4
5-1	Project Cost Estimate for Modification of Principal Spillway, Per Flood Control Structure.....	5-1
5-2	Recharge Enhancement Cost Summary .....	5-2

## 1.0 INTRODUCTION

Flood control structures located in the Salado Creek, York Creek, Comal River, and Upper San Marcos River watersheds have been designed and constructed by the Natural Resources Conservation Service (formerly Soil Conservation Service) in cooperation with local sponsors. Many of the flood control structures were constructed on the Edwards Aquifer recharge zone and provide additional recharge to the aquifer by impounding floodwater and allowing it to infiltrate into the aquifer over a period of several days.

The principal spillways of Natural Resources Conservation Service (NRCS) flood control structures are designed to evacuate the floodwater retarding pool within a 10-day period, commencing from the time the maximum flood pool elevation is attained. This standard accounts for the possibility of successive major storm events.<sup>1</sup> The floodwater retarding pool consists of that portion of the reservoir allotted to the temporary impoundment of floodwater with its upper limit being the elevation of the auxiliary or emergency spillway crest. In practice, the criteria are considered to be satisfied if the floodwater retarding pool is evacuated to below 15-percent of the flood pool capacity. Significant recharge rates which contribute to the evacuation of floodwater from the reservoirs have been observed at structures located in the Edwards Aquifer recharge zone.<sup>2</sup> In the original design of many of these structures, the rate of recharge in the reservoir pool area was not considered in calculating the required spillway discharge capacity for meeting the 10-day drawdown design criteria. If the actual drawdown time is less than 10 days because of recharge in the reservoir pool area, the principal spillway could be modified to reduce or eliminate releases in order to enhance recharge and still satisfy the 10-day drawdown design criteria. The primary objective of this study is to assess the potential for enhancement of recharge to the Edwards Aquifer by modifying the principal spillways of three selected flood control structures in the Guadalupe-San Antonio River Basin.

---

<sup>1</sup> Soil Conservation Service, "Earth Dams and Reservoirs," Technical Release No. 60, October 1990.

<sup>2</sup> San Antonio River Authority, "Flood Control and Edwards Recharge at Salado Site 8, Storm Event on April 4, 1991," videotape.

(This page intentionally left blank.)



## 2.0 SITE SELECTION

A total of 22 flood control structures have been constructed on the Edwards Aquifer recharge zone in the Salado Creek, York Creek, Comal River, and Upper San Marcos River watersheds. Table 2-1 characterizes these structures by watershed, drainage area controlled, and floodwater storage capacity. Of the four watersheds considered, the Salado Creek watershed has the most extensive program of NRCS flood control structures on the Edwards Aquifer recharge zone.

<b>Table 2-1</b>			
<b>Summary of NRCS Flood Control Structures</b>			
<b>On the Edwards Aquifer Recharge Zone</b>			
<b>Watershed</b>	<b>Structure I.D.</b>	<b>Drainage Area (square miles)</b>	<b>Storage Capacity<sup>1</sup> (acre-feet)</b>
Salado Creek	4	5.51	1,982
	5	8.86	3,293
	6	4.58	1,490
	8	11.18	4,178
	9	2.37	1,026
	10	4.78	1,846
	11	6.56	2,598
	12	12.70	4,875
	13A	3.28	1,441
	13B	2.53	1,093
York Creek	1	12.93	3,178
	2	2.80	586
Comal River	1	18.52	3,793
	2	30.15	7,878
	3	11.56	3,422
	4	12.97	3,604
	5	1.38	394
Upper San Marcos River	1	33.57	8,683
	2	4.35	1,275
	3	5.67	1,011
	4	20.17	4,788
	5	14.41	3,167
<b>Total</b>		<b>230.83</b>	<b>65,601</b>
Notes:			
1. Storage capacity presented is the total storage capacity, including sediment reserve, at the auxiliary spillway crest elevation.			

For this study, three flood control structures were to be selected for detailed analyses of their potential for modification for recharge enhancement. Flood control structures in the Upper San Marcos River watershed were designed considering the recharge rates that exist in the reservoir pool areas and, therefore, were not selected for further study. Flood control structures in the upper portion of the York Creek watershed were designed as NRCS Class A structures, which do not have spillway capacities as large as the Class C structures constructed in the other watersheds. In some cases, the York Creek structures may not meet current Hydrologic Criteria for Dams as required by the Texas Natural Resource Commission.<sup>1</sup> Based on the present hydraulic capacity of the York Creek structures, further reduction of the principal spillway capacity at these structures may not be feasible.

Five flood control structures in the Comal River watershed are located on the Edwards Aquifer recharge zone. Based on personal interviews with local NRCS representatives, Site 3 and Site 4 are the most likely sites at which to implement reductions in the hydraulic capacity of the principal spillways. Subordination agreements with adjacent landowners that allow for constriction of the principal spillway are presently in place at these sites. A review of NRCS design files obtained from the NRCS state office indicated that recharge was considered in the design of Site 3. No data could be located in the design files that indicated that recharge was considered in the design of Site 4.

Flood control structures in the Salado Creek watershed appear to offer the most potential for additional recharge enhancement by modifying the principal spillways. A total of ten of the Salado Creek flood control structures are located on the Edwards Aquifer recharge zone. Of these ten structures, six were not considered for further study due to existing residential development or other commercial activity around the perimeter of the flood pool, or because of downstream water right issues. Reduction of the principal spillway capacity at one of these structures would produce higher flood levels in the upstream pool potentially impacting upstream development, and could reduce water available for diversion downstream of the structure. Of the remaining four Salado Creek structures, the principal spillway discharge from Site 8 has been observed to recharge prior to arriving at the next downstream structure. Therefore, the recharge

---

<sup>1</sup> Texas Natural Resource Conservation Commission, "Guidelines for Operation and Maintenance of Dams in Texas," September 1990.

of floodwater is considered to be near its maximum potential for this structure and a reduction in spillway capacity would not offer additional recharge benefit. In the Salado Creek watershed, Site 11 and Site 13A appear to have the least potential conflicts associated with reduction of the principal spillway discharge capacity.

For purposes of this study, Salado Creek Site 11, Salado Creek Site 13A, and Comal River Site 4 were selected for detailed study. These three sites appear to offer the greatest potential for modification of the principal spillway and enhancement of recharge within their respective reservoir pools. The locations of the three selected sites in the Salado Creek and Comal River watersheds are shown in Figure 2-1.

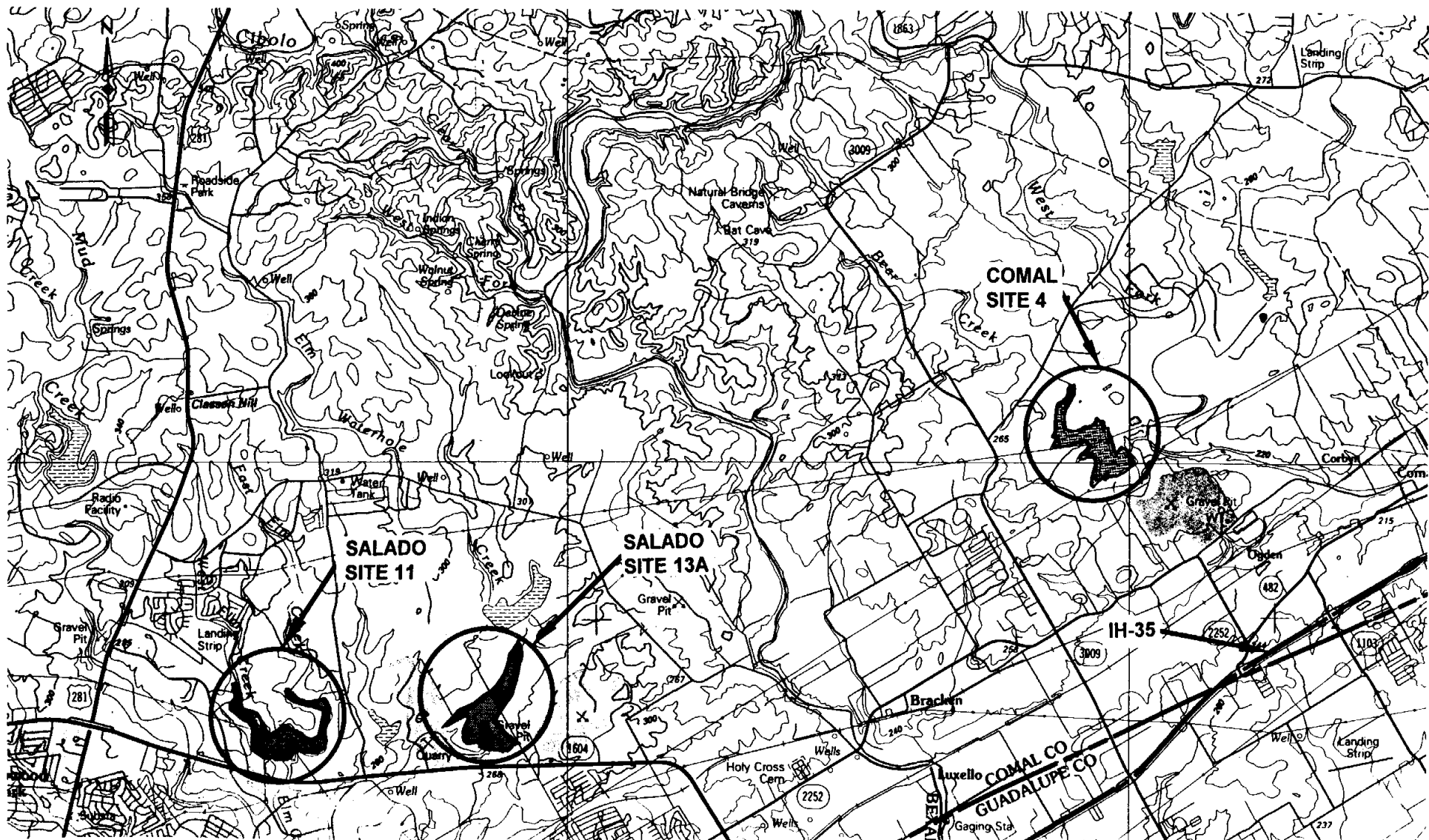

**SITE SELECTED  
FOR ANALYSIS**

**APPROXIMATE  
SCALE IN FEET**



**TRANS TEXAS WATER PROGRAM  
WEST CENTRAL STUDY AREA**

**LOCATION MAP  
POTENTIAL SITES FOR  
OUTLET MODIFICATIONS**



HDR Engineering, Inc.

**FIGURE 2 - 1**

*MODIFICATION OF PRINCIPAL SPILLWAYS AT  
EXISTING FLOOD CONTROL PROJECTS FOR  
RECHARGE ENHANCEMENT*

### **3.0 FLOOD HYDROLOGY ANALYSIS**

Any modification of the principal spillway at the selected sites is contingent upon the structure meeting the requirements of the original design criteria. More specifically, the maximum water-surface elevation attained under a simulation of the design storm event must be lower than the crest of the emergency spillway, and the floodwater retarding pool must evacuate to less than 15 percent of the total floodwater capacity within 10 days.

A flood hydrology model was developed for each site to assess the performance of the principal spillway as constructed, and under various degrees of constriction. The flood hydrology model for each site was utilized to simulate the design storm event, compute the hydraulic rating for the principal spillway, and compute the maximum water-surface elevation and drawdown time for the design storm event. Elevation-recharge rate relationships were developed for each site to estimate the amount of recharge from the reservoir pool that might occur during the design storm event. Spillway hydraulic capacity and the elevation-recharge relationships were used to determine the reduction of the principal spillway capacity that could occur and still satisfy allowable flood elevation constraints and 10-day drawdown design criteria. Specific tasks performed to evaluate the effects of principal spillway capacity reductions on flood hydrology for each site include:

1. Collect structure design and watershed data;
2. Develop flood hydrology model;
3. Compute the time to evacuate the retarding pool without considering recharge;
4. Develop an elevation-recharge rate relationship;
5. Compute the time to evacuate the retarding pool considering recharge; and
6. Calculate the reduction of the principal spillway capacity that could be made and still meet the hydrologic design criteria considering recharge.

#### **3.1 Data Collection and Model Development**

As-built structure information and flood hydrology parameters (drainage area, runoff curve number, time of concentration, etc.) used in the design of each site were obtained from the NRCS. The flood hydrology information was obtained from archived records, some of which were incomplete and inconclusive regarding parameters ultimately selected to develop the design flood hydrology model for each site. When a final design parameter was in doubt, the most

reasonable value was selected and supported with information from other sources such as topographic maps and soil surveys.

The flood hydrology parameters were used to develop a SITES<sup>1</sup> model for each flood control structure to calculate a principal spillway discharge rating table, simulate the design storm, route the resulting runoff hydrograph, and compute the maximum water-surface elevation and drawdown time. The SITES computer program is the current version of the NRCS DAMS2 program, which was utilized in the original design of most of the structures. The DAMS2 and SITES programs perform flood hydrology computations in accordance with the procedures outlined in TR-60<sup>2</sup> and Chapter 21 of NEH-4<sup>3</sup>. These references present criteria and procedures for developing principal spillway hydrographs (PSHs) for the design of flood retarding structures. The PSH adopted by the NRCS is a function of the direct runoff mass curve from the 100-year, 10-day precipitation depth, and the direct runoff volume from the 100-year, 24-hour precipitation depth. The SITES model also calculates principal spillway rating tables from dimensions and elevations of principal spillway appurtenances.

The NRCS utilizes a standard principal spillway configuration for most flood retarding structures. This configuration includes a tower drop inlet structure which is controlled by an overflow weir. Flow from the inlet structure is conveyed by a circular conduit through the dam and discharged to the channel downstream. The overflow weir usually is sized to control the flow up to an elevation about 1.5 to 2 feet above the weir crest, above which the outlet conduit controls flow through the principal spillway. The volume contained between the reservoir bottom and the crest of the principal spillway weir usually is considered “dead” storage, and is reserved for sediment accumulation over the life of the structure. The design flood routings begin with the storage set equal to the principal spillway crest elevation. Figure 3-1 presents a schematic drawing of a typical NRCS flood retardation structure.

The Texas Natural Resource Conservation Commission requires water rights permits for dams that impound more than 200 acre-feet of water. For sites where hydrologic design

---

<sup>1</sup> Natural Resources Conservation Service, “SITES, Water Resource Site Analysis Computer Program,” December 1996.

<sup>2</sup> Soil Conservation Service, “Earth Dams and Reservoirs,” Technical Release No. 60, October 1990.

<sup>3</sup> Soil Conservation Service, “SCS National Engineering Handbook, Section 4, Hydrology,” March 1985.

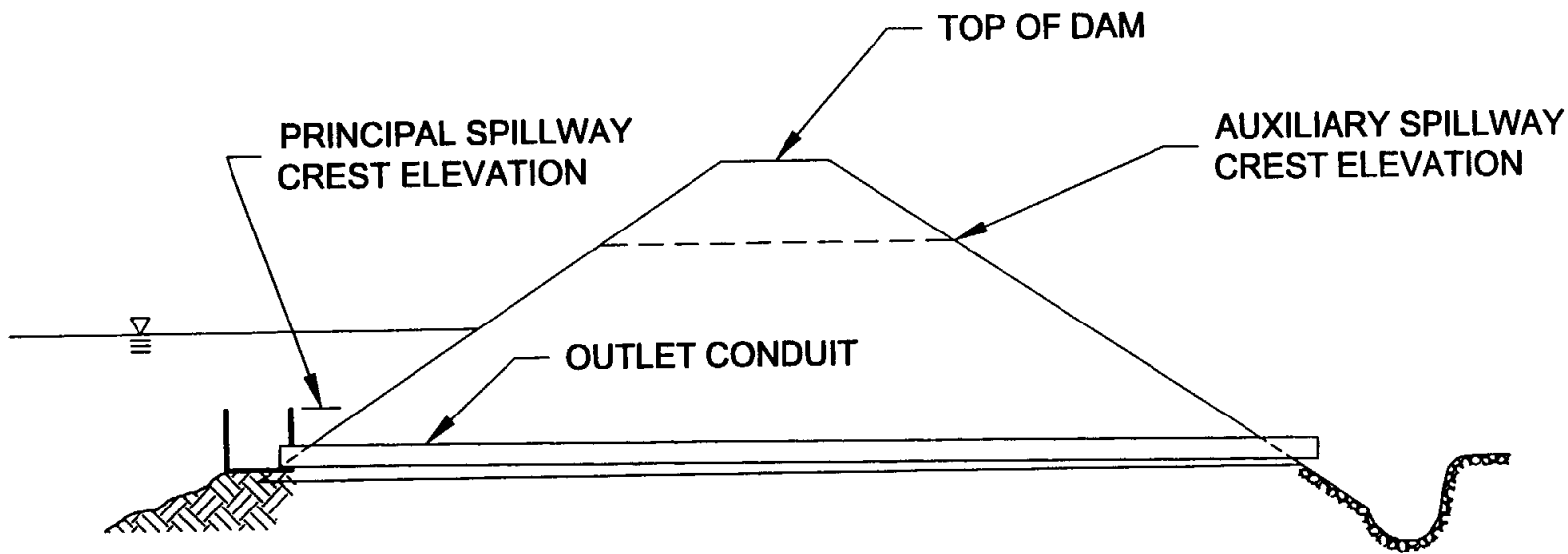

MODIFICATION OF PRINCIPAL SPILLWAYS AT  
EXISTING FLOOD CONTROL PROJECTS FOR  
RECHARGE ENHANCEMENT



HDR Engineering, Inc.

TRANS TEXAS WATER PROGRAM /  
WEST CENTRAL STUDY AREA

**TYPICAL NRCS FLOOD  
RETARDATION STRUCTURE**

FIGURE 3 - 1

constraints cause the structure to impound more than 200 acre-feet below the principal spillway crest elevation, the NRCS has incorporated portholes in the sides of the drop inlet tower. These portholes are positioned at the elevation corresponding to 200 acre-feet storage to allow automatic drawdown to below this elevation. These portholes usually have an insignificant effect on the outflow rating of the principal spillway. The Comal River Site 4 includes these portholes. They were not included in the flood routings. Pertinent data used to compute the principal spillway rating and determine drawdown times are presented in Table 3-1.

<b>Site Characteristic</b>	<b>Site</b>		
	<b>Comal River Site 4</b>	<b>Salado Creek Site 11</b>	<b>Salado Creek Site 13A</b>
Principal Spillway Crest Elevation (ft-msl)	763.4	845.3	861.8
Emergency Spillway Crest Elevation (ft-msl)	798.8	877.8	877.0
Storage at Principal Spillway Crest (acft)	298	84	128
Storage at Emergency Spillway Crest (acft)	3,605	2,598	1,441
Elevation at 15% Flood Control Storage (ft-msl)	774.8	857.3	866.4
Weir Length (ft)	15	15	16.3
Conduit Diameter (inches)	30	30	36
Conduit Length (ft)	340	200	230
Conduit Tailwater Elevation (ft-msl)	739.2	837.0	849.0

### **3.2 Performance of Flood Control Structures without Considering Recharge**

The design inflow hydrograph for each site was computed using the SITES model and routed through the existing flood control structure. Recharge from the reservoir pool was not considered in the initial flood routings. The flood hydrology model parameters for each of the three selected sites are presented in Table 3-2. The initial flood routings are summarized in Table 3-3.

As shown in Table 3-3, Comal River Site 4 does not meet either the maximum water surface elevation or the 10-day drawdown criteria. Because recharge was considered in the design of Comal River Site 3, recharge likely was considered in the design of Comal River Site 4. Salado Creek Site 11 meets the maximum water-surface elevation criteria, but does not



meet the 10-day drawdown criteria. Salado Creek Site 13A does not meet the maximum water-surface elevation criteria, but does meet the 10-day drawdown criteria.

Site	Drainage Area (sq. mi.)	SCS Runoff CN	Time of Conc. (hrs)	Precipitation Depth	
				24-hr Total (inches)	10-day Total (inches)
Comal River Site 4	12.97	77	3.6	9.8	16.0
Salado Creek Site 11	6.56	81	2.3	9.8	16.0
Salado Creek Site 12 <sup>1</sup>	12.70	79	2.8	9.8	16.0
Salado Creek Site 13A <sup>2</sup>	3.28	81	1.0	9.8	16.0

Notes:  
 1. Upstream of Salado Site 13A.  
 2. Drainage area shown is uncontrolled area; it does not include area controlled by Site 12.

Site	Peak Inflow (cfs)	Peak Outflow (cfs)	Emergency Spillway Crest Elevation (ft-msl)	Maximum Water Surface Elevation (ft-msl) <sup>1</sup>	Drawdown Time (days) <sup>2</sup>
Comal River Site 4	8,323	148	798.8	801.1	14.1
Salado Creek Site 11	6,927	139	877.8	877.7	10.7
Salado Creek Site 12 <sup>3</sup>	11,934	148	936.2	935.1	5.7
Salado Creek Site 13A <sup>4</sup>	5,963	166	877.0	878.4	8.2

Notes:  
 1. If higher than the elevation of the emergency spillway, the routing was performed assuming that the emergency spillway is blocked.  
 2. Does not include recharge from flood control pool, except for Site 12. Drawdown time is measured from time of peak water-surface elevation in flood pool to 15-percent flood pool storage.  
 3. Peak outflow is outflow through principal spillway only, and was computed with recharge considered. Peak outflow and drawdown time without recharge considered are 153 cfs and 18.5 days, respectively.  
 4. Peak inflow is computed considering recharge at Site 12, which does not substantially reduce the peak inflow, but reduces the length of time inflow is received from Site 12.

Salado Creek Site 12 is a flood control structure upstream of Site 13A, and controls 12.70 square miles of the total 15.98 square mile watershed. Site 12 was included in the Site 13A flood hydrology model. Neither Site 12 or Site 13A meet the 10-day drawdown criteria without consideration of recharge, but Site 12 does meet the requirement with recharge considered. Recharge from the Site 12 flood control pool was reflected in all flood routings for

considered. Recharge from the Site 12 flood control pool was reflected in all flood routings for Site 13A. Site 12 was not studied (beyond inclusion in the Site 13A model), because a quarry operation is located within and adjacent to its flood control pool, and constriction of the principal spillway could be problematic.

### **3.3 Performance of Flood Control Structures Considering Recharge**

An elevation-recharge rate relationship was developed for each site, based upon the elevation-area inundated relationship for each site and an estimate of the permeability of the soil cover in the flood-control pool. Soil cover permeabilities were estimated from the Soil Survey of Comal and Hays Counties<sup>4</sup> and the Soil Survey of Bexar County<sup>5</sup>. This method for estimating recharge has been shown to be applicable for recharge reservoirs in the Nueces River Basin<sup>6</sup>. The method does not take into account the increase in head on the soil cover as the reservoir stage rises and the increase in recharge rate that would result. It also does not take into account that much of the native soil was excavated from the reservoir pool area of many sites. Therefore, the elevation-recharge rate estimates likely are less than actual recharge rates.

The elevation-recharge rating was combined with the principal spillway rating table computed by the SITES model to develop a combined elevation-recharge-outflow rating for each site. The flood routings are summarized in Table 3-4. Comal Site 4 failed to meet both the maximum water-surface elevation and the 10-day drawdown criteria when recharge was considered.

### **3.4 Evaluation of Principal Spillway Constriction**

Constriction of the principal spillway will require either constricting the entrance into the drop inlet, constricting the entrance into the conduit, or constricting the exit of the conduit and could be accomplished using some form of orifice plate, valve, or sluice gate. A feasible approach that would allow the degree of constriction to be reduced or increased, based on observation of performance, is installation of a removable orifice plate at the entrance to the

---

<sup>4</sup> Soil Conservation Service, "Soil Survey of Comal and Hays Counties, Texas," June 1984.

<sup>5</sup> Soil Conservation Service, "Soil Survey of Bexar County, Texas," June 1991.

<sup>6</sup> HDR Engineering, Inc., "Edwards Aquifer Recharge Enhancement Project, Phase IVA, Nueces River Basin," June 1994.

outlet conduit. This plate could be adjusted up or down to modify the degree of constriction of the principal spillway.

Site	Principal Spillway Peak Outflow (cfs)	Peak Recharge Rate (cfs)	Emergency Spillway Crest Elevation (ft-msl)	Maximum Water Surface Elevation (ft-msl) <sup>1</sup>	Drawdown Time (days)
Comal River Site 4	147.6	30.5	798.8	800.7	12.4
Salado Creek Site 11	136.7	140.4	877.8	876.5	6.1
Salado Creek Site 13A	161.2	91.0	877.0	876.6	7.3

Note:  
1. If higher than the elevation of the emergency spillway, the routing was performed assuming that the emergency spillway is blocked.

A series of constricted principal spillway elevation-discharge ratings were developed for each site, consistent with the methods described in NEH-5.<sup>7</sup> The ratings under low levels of constriction agree closely with those calculated by the SITES program. These ratings were combined with the elevation-recharge ratings to develop combined recharge-spillway ratings, and were entered into the SITES program. The opening that resulted in approximately a 10-day drawdown time was selected. Figures 3-2, 3-3, and 3-4 illustrate the principal spillway ratings utilized for Comal River Site 4, Salado Creek Site 11, and Salado Creek Site 13A, respectively.

The flood routings for Salado Creek Sites 11 and 13A are summarized in Table 3-5. Comal River Site 4 failed to meet either the maximum water-surface elevation or the 10-day drawdown criteria without constriction of the spillway and was eliminated from further consideration. Both Salado Creek sites were able to meet the 10-day drawdown criteria, but Site 13A does not meet the maximum water-surface elevation criteria. If the spillway is constricted at Salado Creek Site 13A, modification of the auxiliary spillway to include an erodible berm (fuse plug) may be required to meet the NRCS design criteria. This berm could be designed to erode (fail) when overtopped, thereby allowing floods larger than the design event to pass

<sup>7</sup> Soil Conservation Service, "National Engineering Handbook, Section 5, Hydraulics," 1956.

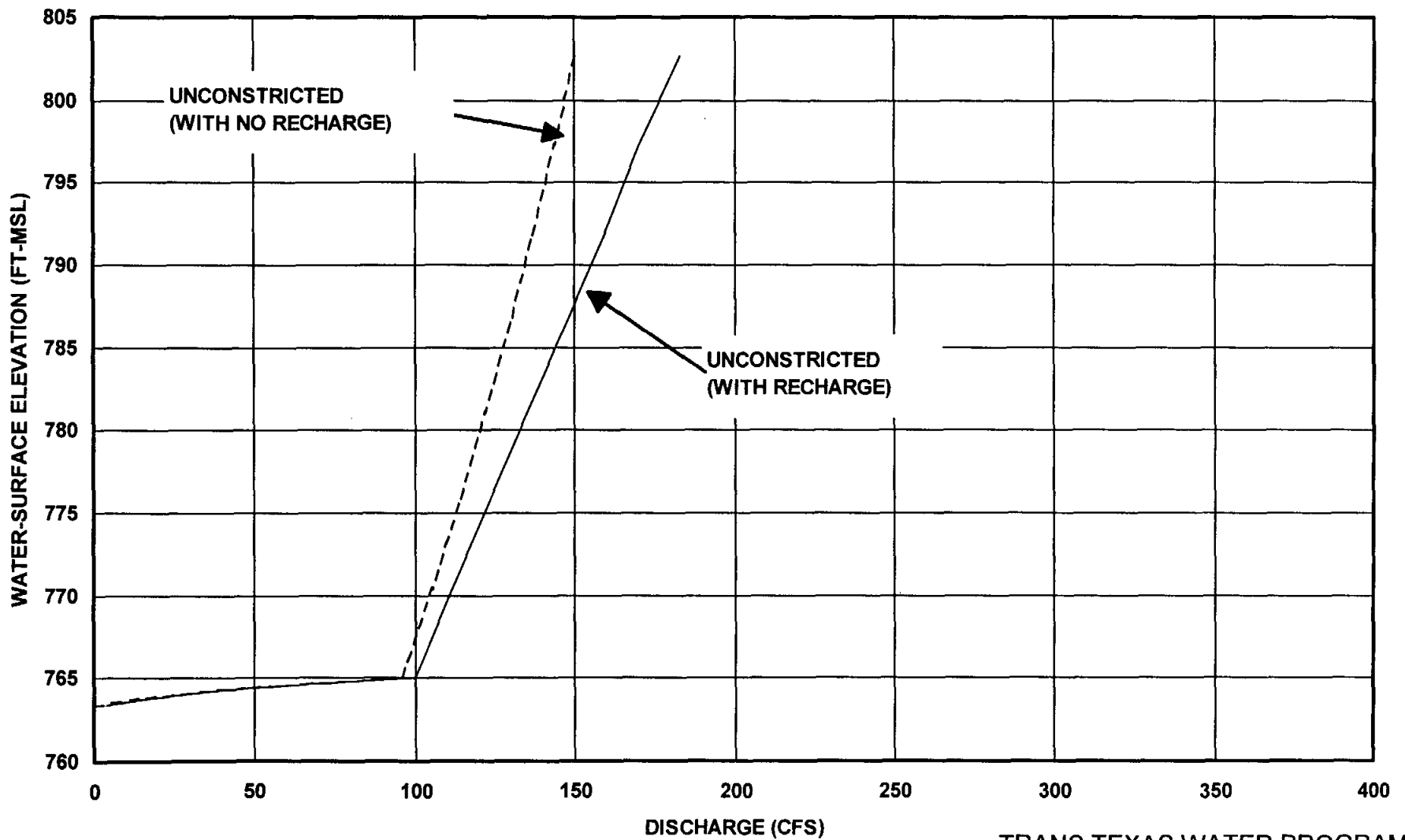

TRANS TEXAS WATER PROGRAM /  
WEST CENTRAL STUDY AREA

**COMAL SITE 4  
UNCONSTRICTED PRINCIPAL  
SPILLWAY RATINGS**

FIGURE 3 - 2

*MODIFICATION OF PRINCIPAL SPILLWAYS AT  
EXISTING FLOOD CONTROL PROJECTS FOR  
RECHARGE ENHANCEMENT*



HDR Engineering, Inc.

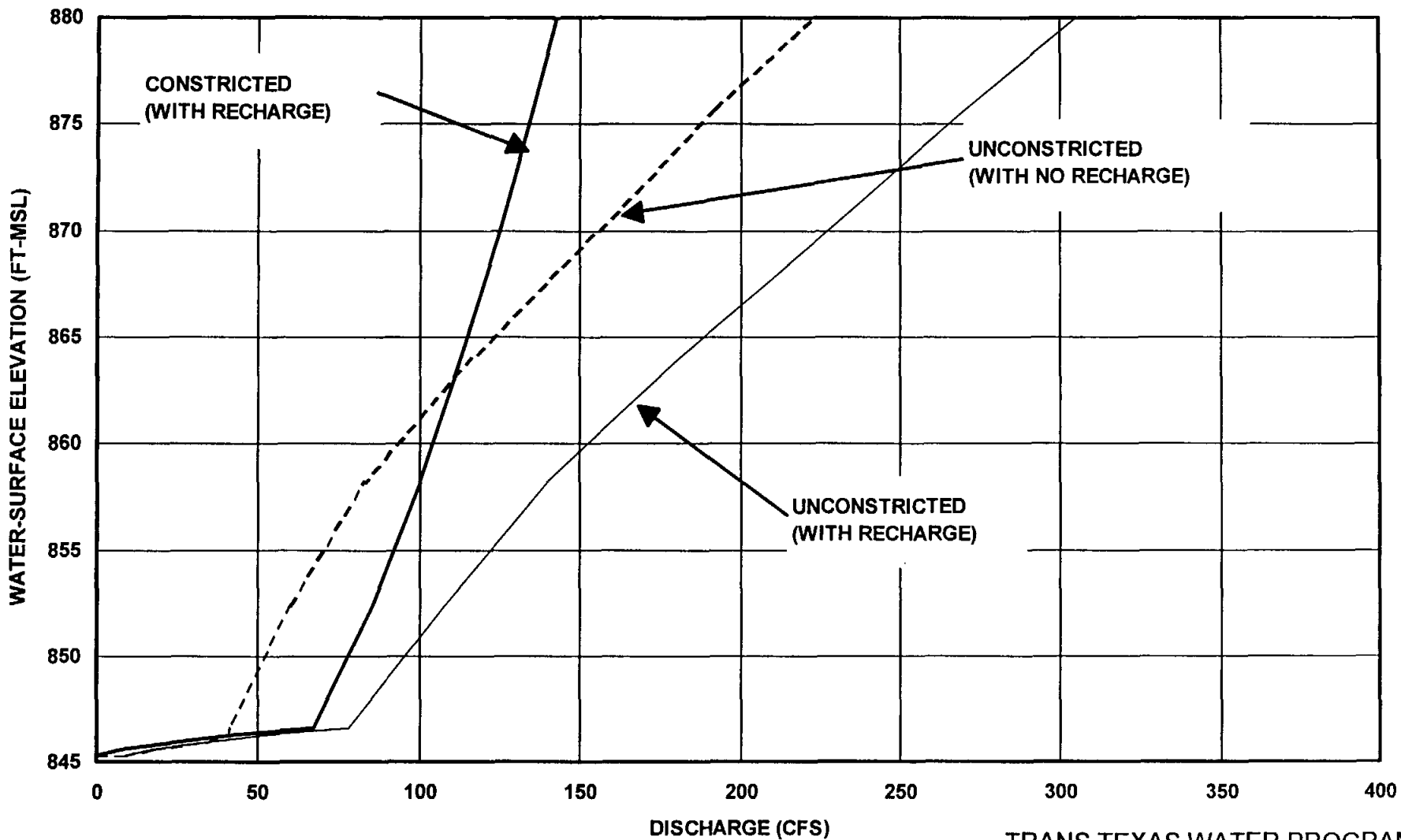

TRANS TEXAS WATER PROGRAM /  
WEST CENTRAL STUDY AREA

**SALADO SITE 11  
UNCONSTRICTED AND  
CONSTRICTED PRINCIPAL  
SPILLWAY RATINGS**  
FIGURE 3 - 3

MODIFICATION OF PRINCIPAL SPILLWAYS AT  
EXISTING FLOOD CONTROL PROJECTS FOR  
RECHARGE ENHANCEMENT



HDR Engineering, Inc.

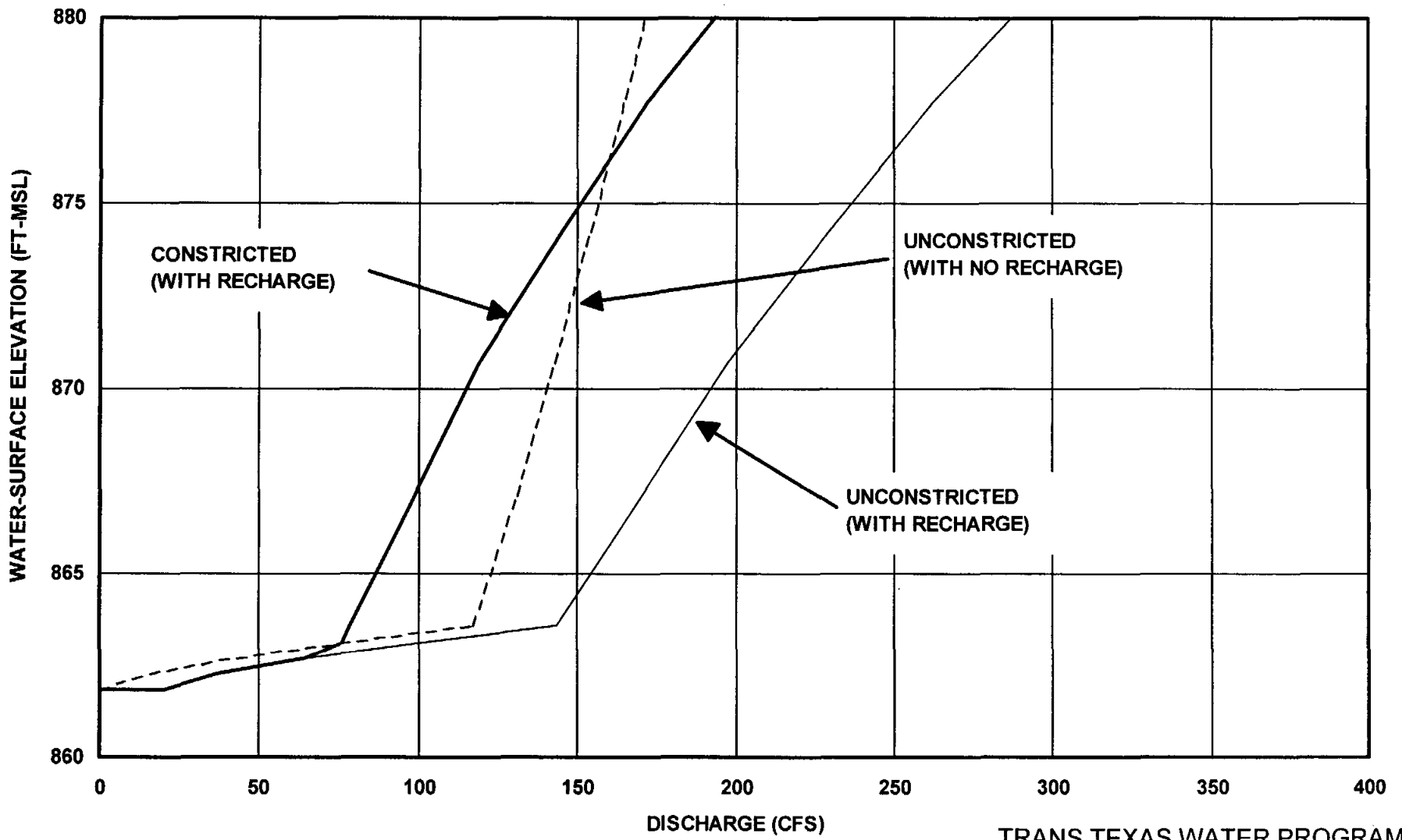

TRANS TEXAS WATER PROGRAM /  
WEST CENTRAL STUDY AREA

**SALADO SITE 13A  
UNCONSTRICTED AND  
CONSTRICTED PRINCIPAL  
SPILLWAY RATINGS**  
FIGURE 3 - 4

MODIFICATION OF PRINCIPAL SPILLWAYS AT  
EXISTING FLOOD CONTROL PROJECTS FOR  
RECHARGE ENHANCEMENT



HDR Engineering, Inc.

unimpeded through the emergency spillway. Figures 3-5, 3-6, and 3-7 present the stage hydrographs for each of the scenarios analyzed.

Site	Principal Spillway Peak Outflow (cfs)	Peak Recharge Rate (cfs)	Emergency Spillway Crest Elevation (ft-msl)	Maximum Water-Surface Elevation Attained (ft-msl) <sup>1</sup>	Drawdown Time (days)
Comal River Site 4	N/A	N/A	N/A	N/A	N/A
Salado Creek Site 11	59.3	148.0	877.8	877.7	9.2
Salado Creek Site 13A	75.1	105.4	877.0	878.7	9.7
Notes:					
1. If higher than the elevation of the emergency spillway, the routing was performed assuming that the emergency spillway is blocked.					

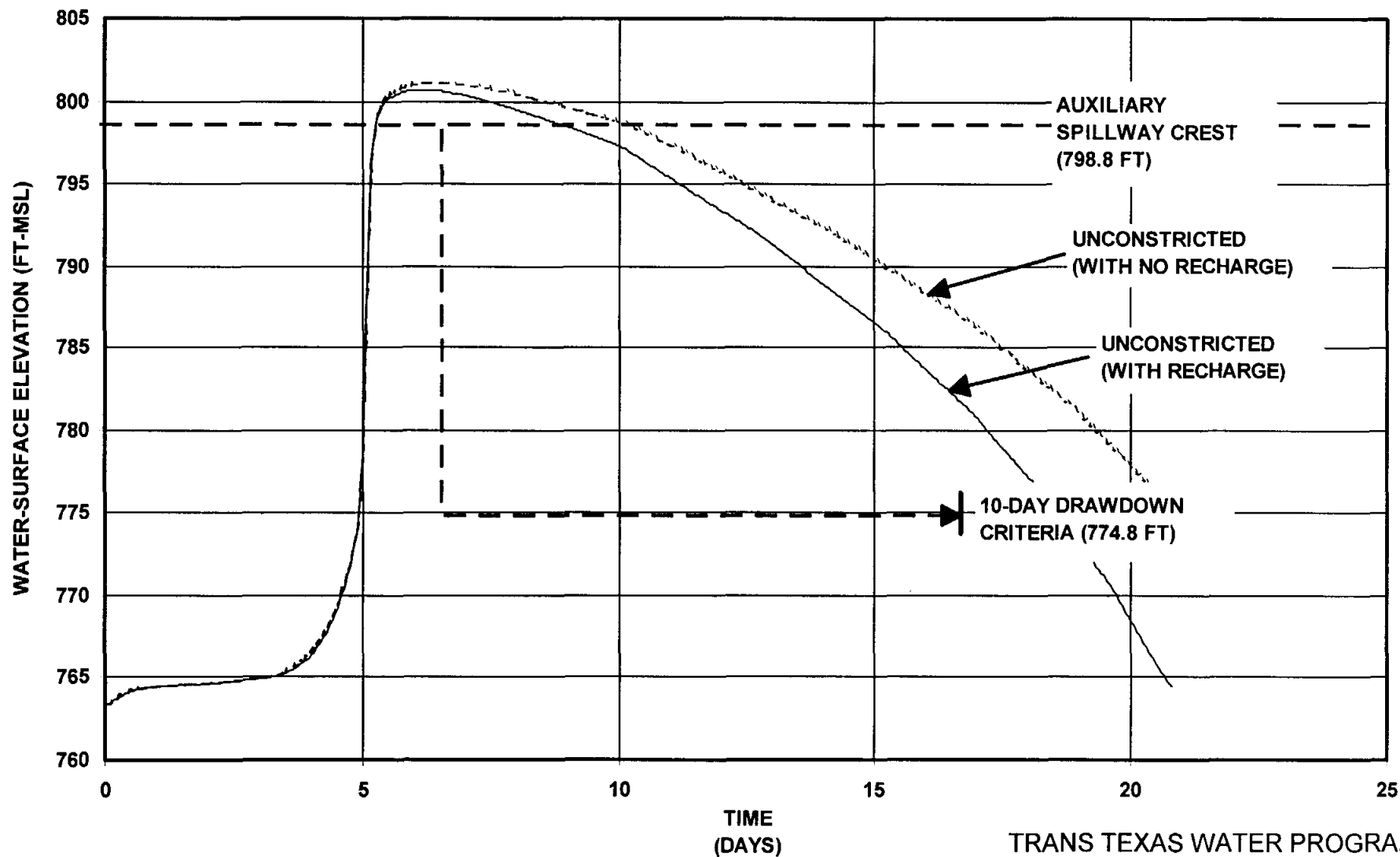

TRANS TEXAS WATER PROGRAM /  
WEST CENTRAL STUDY AREA

COMAL SITE 4  
FLOOD POOL HYDROGRAPH

MODIFICATION OF PRINCIPAL SPILLWAYS AT  
EXISTING FLOOD CONTROL PROJECTS FOR  
RECHARGE ENHANCEMENT



HDR Engineering, Inc.

FIGURE 3 - 5



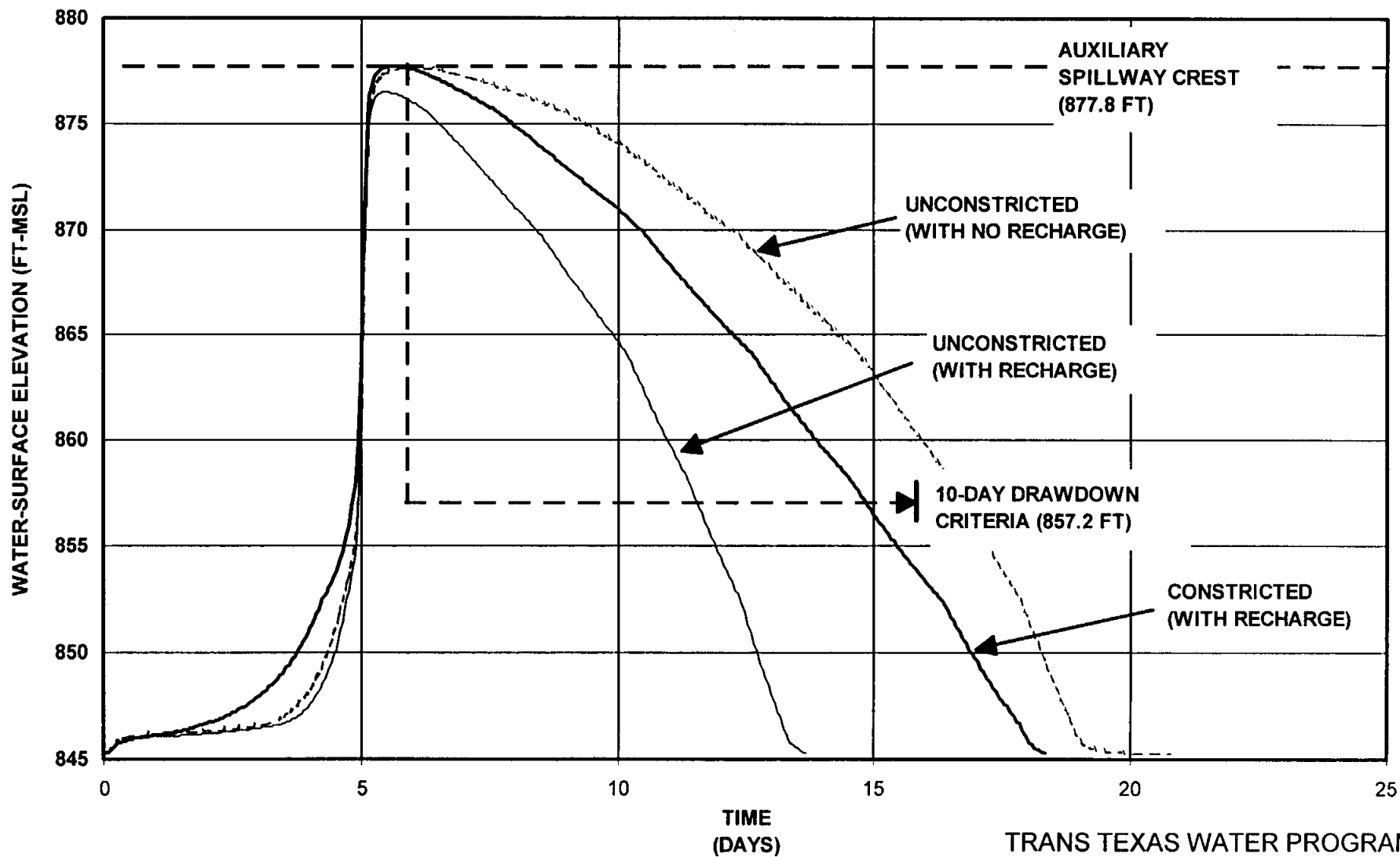

TRANS TEXAS WATER PROGRAM /  
WEST CENTRAL STUDY AREA

**SALADO SITE 11  
FLOOD POOL HYDROGRAPH**



HDR Engineering, Inc.

FIGURE 3 - 6

MODIFICATION OF PRINCIPAL SPILLWAYS AT  
EXISTING FLOOD CONTROL PROJECTS FOR  
RECHARGE ENHANCEMENT

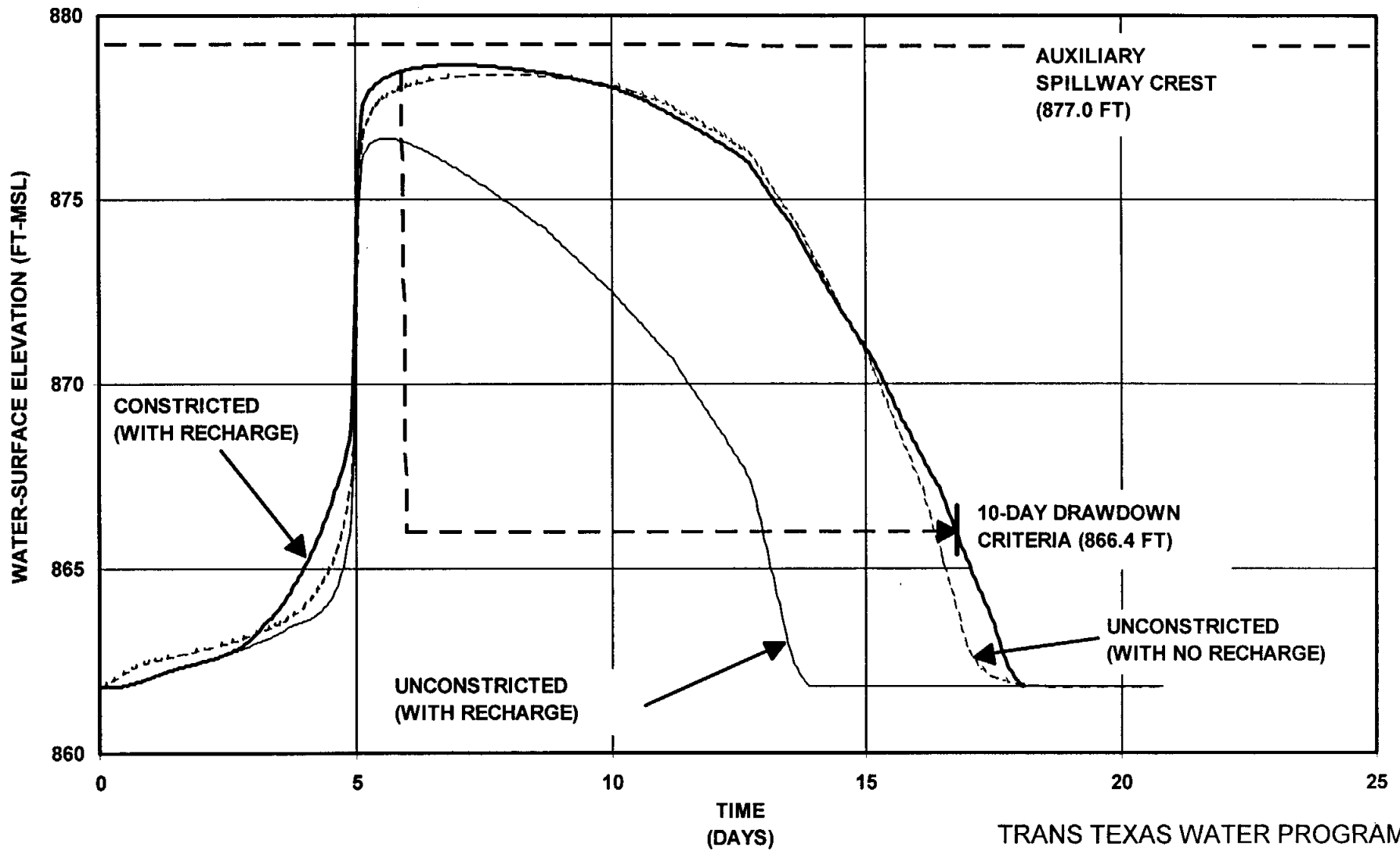

TRANS TEXAS WATER PROGRAM /  
WEST CENTRAL STUDY AREA

**SALADO SITE 13A  
FLOOD POOL HYDROGRAPH**

MODIFICATION OF PRINCIPAL SPILLWAYS AT  
EXISTING FLOOD CONTROL PROJECTS FOR  
RECHARGE ENHANCEMENT

**HDR**

HDR Engineering, Inc.

FIGURE 3 - 7

#### 4.0 RECHARGE ENHANCEMENT POTENTIAL

Modification of the principal spillways by reducing the discharge capacity will enhance recharge to the Edwards Aquifer by reducing the amount of outflow from the reservoir and allowing it to recharge within the upstream reservoir area. The amount of recharge enhancement that may be obtained by modifying the spillway can be demonstrated by examining a series of hypothetical storm events and calculating the amount of floodwater that would recharge into the aquifer with and without the spillway modification. Table 4-1 summarizes a series of hypothetical, 24-hour storm (SCS Type II) events for Salado Creek Site 11, ranging from storm depths of 2 inches to almost 10 inches. For storm events with rainfall depths less than 5 inches, the volume of runoff recharged under present conditions would range from 20 percent to 30 percent of the total volume of runoff. Reducing the principal spillway discharge capacity by about 60 percent results in the volume of recharge increasing to 30 percent to 50 percent of the total runoff volume. For larger storm events with storm depths exceeding five inches, the volume of recharge under present conditions would range from 30 percent to 40 percent of the total runoff volume. Reducing the principal spillway discharge capacity results in the volume of recharge increasing to 50 percent to 60 percent of the total runoff volume.

24-hour Storm Rainfall (inches)	Runoff Volume <sup>2</sup> (inches) (ac-ft)		Existing Conditions		With Principal Spillway Modification		Recharge Enhancement <sup>3</sup>	
			Principal Spillway Discharge (ac-ft)	Edwards Aquifer Recharge (ac-ft)	Principal Spillway Discharge (ac-ft)	Edwards Aquifer Recharge (ac-ft)	Recharge Increase (ac-ft)	Percent Recharge Increase (%)
2.0	0.6	211	170	41	141	70	29	73%
3.0	1.3	459	356	102	280	179	77	75%
4.0	2.1	742	548	194	414	328	134	69%
5.0	3.0	1,044	734	310	537	507	197	64%
6.0	3.9	1,358	915	443	653	706	263	59%
7.0	4.8	1,681	1,092	589	762	919	330	56%
8.0	5.7	2,009	1,263	745	867	1,142	397	53%
9.0	6.7	2,340	1,431	909	967	1,374	465	51%
9.8 <sup>1</sup>	7.5	2,609	1,563	1,046	1,045	1,563	518	50%

Notes:

1. Storm total rainfall for the 100-year return period storm event.
2. Runoff volume based on computation using the SCS Runoff Curve Number Method with a runoff curve number of 81.
3. Recharge enhancement is the difference between the Edwards Aquifer recharge with principal spillway modification and existing conditions.

While the single storm event analysis demonstrates the potential for recharge enhancement by reducing the discharge capacity of the principal spillway, assessment of the long-term benefits requires the analysis to be expanded to cover a time period of many years. Assessment of the long-term recharge enhancement benefits of NRCS flood control structures is a feature incorporated into the Guadalupe-San Antonio River Basin Model (GSA Model).<sup>1</sup> The GSA Model utilizes a methodology for estimating recharge enhancement by NRCS flood control structures on a monthly time step. Historical recharge for the 1934-89 period was developed for watersheds upstream of and on the Edwards Aquifer recharge zone that included a program of NRCS flood control structures. In order to assess the recharge characteristics of the NRCS structures, it was presumed that historical recharge ( $R$ ) is comprised of natural recharge ( $R_N$ ) and additional components associated with the normal pool ( $R_{NP}$ ) and active pool ( $R_{AP}$ ) storage of the NRCS structures as defined in the following equations:

$$R = R_N + R_{NP} + R_{AP} \quad [4-1]$$

$$R_{NP} = c_{NP} \left( \frac{A_c}{A} \right) (QI - R_N) \leq c_{NP} (NP) \quad [4-2]$$

$$R_{AP} = c_{AP} \left[ \left( \frac{A_c}{A} \right) (QI - R_N) - R_{NP} \right] \leq c_{AP} (AP) \quad [4-3]$$

where:

- $R$  = Historical Recharge;
- $R_N$  = Natural Recharge;
- $R_{NP}$  = SCS/FRS Normal Pool Recharge;
- $R_{AP}$  = SCS/FRS Active Pool Recharge;
- $QI$  = Potential Runoff;
- $A_c$  = Watershed Area Controlled;
- $A$  = Total Watershed Area;
- $c_{NP}$  = Normal Pool Recharge Coefficient;
- $c_{AP}$  = Active Pool Recharge Coefficient;
- $NP$  = Aggregate Normal Pool Storage; and
- $AP$  = Aggregate Active Pool Storage.

The methodology used to estimate the recharge coefficients included the development of monthly natural recharge estimates obtained from a linear regression between the natural and potential runoff based on available data prior to construction of the NRCS flood control

---

<sup>1</sup> HDR Engineering, Inc., "Guadalupe-San Antonio River Basin Recharge Enhancement Study," Edwards Aquifer

structures. The normal pool recharge coefficient was assumed to equal 1.0 which implies that 100 percent of the water impounded within the normal pools (below the principal spillway crest elevation) will contribute to recharge, neglecting evaporation. Historical monthly recharge was then computed based on the equations using various assumed values for the active pool recharge coefficient. An assumed active pool recharge coefficient of 0.63 resulted in the least error in estimating historical recharge in the Salado Creek watershed. This result implies that, over a long-term period, approximately 63 percent of the runoff temporarily impounded by the NRCS flood control structures contributes to recharge, neglecting evaporation. This same procedure was applied in the Comal River watershed. The active pool recharge coefficient in the Comal River watershed was found to be 0.70, which is slightly higher than the Salado Creek watershed and likely a result of recharge being included in the design of Comal River structures.

For the two selected Salado Creek flood control structures, Site 11 and Site 13A, the design principal spillway discharge was reduced 57 percent (135 cfs to 58 cfs) and 55 percent (165 cfs to 74 cfs), respectively. For purposes of estimating the long-term recharge enhancement benefits of reducing the spillway capacity by this amount, the corresponding percentage of active pool storage was simulated in the GSA Model as normal pool storage. For example, the normal pool storage for Site 11 is 84 acre-feet and the active pool storage is 2,512 acre-feet. Design storm routings indicate that the principal spillway discharge capacity could be reduced by 57 percent and meet the 10-day drawdown design criteria. Therefore, for simulating the recharge enhancement benefits for Site 11 in the GSA Model, the normal pool storage was increased by 1,432 acre-feet, the corresponding percentage of active pool storage (57% of 2,512 acre-feet) and the active pool storage was reduced by the same amount. For Site 13A, the normal pool storage of 128 acre-feet and active pool storage of 1,313 acre-feet were increased and reduced by 722 acre-feet (55% of 1,313 acre-feet), respectively.

Results of the GSA Model simulation indicate that an average of 373 acre-feet per year of additional recharge could potentially be produced by reducing the principal spillway discharge capacity, without impairing the flood-control function of the structures. During the 10-year drought period of 1947 to 1956, additional recharge would be insignificant because the natural

recharge rate and existing flood control structures maximize recharge. Table 4-2 presents a recharge summary for Salado Creek Site 11 and Site 13A.

<b>Table 4-2</b>				
<b>Summary of Recharge Enhancement for Salado Creek Site 11 and Site 13A</b>				
<b>Flood Control Structure</b>	<b>Natural Recharge<sup>1</sup> (acft/yr)</b>	<b>Existing Recharge Enhancement<sup>2</sup> (acft/yr)</b>	<b>Additional Recharge with Modification of Principal Spillway (acft/yr)</b>	<b>Total Recharge (acft/yr)</b>
<b>Site 11</b>				
1934-1989 (average)	2,615	429	249	3,293
1947-1956 (average)	1,054	214	0	1,268
<b>Site 13A</b>				
1934-1989 (average)	1,307	513 <sup>3</sup>	124	1,944
1947-1956 (average)	527	82 <sup>3</sup>	0	609
Notes:				
1. Natural recharge includes recharge within contributing watershed area.				
2. Natural and enhanced recharge based on simulation of GSA Model.				
3. Existing recharge enhancement includes capture and recharge of floodwater discharge from Site 12 located upstream.				

## 5.0 IMPLEMENTATION

Modification of the principal spillways for enhancement of recharge at the existing NRCS flood control structures involves reduction of the spillway discharge capacity. There are several methods for reducing the principal spillway discharge capacity including the recommended installation of an orifice plate in the intake tower to reduce flow into the outlet conduit. Requirements for implementation of the modification should include flexibility to adjust the discharge capacity based on future observations of performance. The conceptual plan includes a steel orifice plate installed over the entrance to the outlet conduit inside of the drop inlet structure. The estimated cost for the conceptual plan as shown in Table 5-1 is approximately \$13,000, which includes installation of the orifice plate, construction contingencies, and engineering costs.

<b>Item</b>	<b>Quantity</b>	<b>Units</b>	<b>Unit Cost</b>	<b>Total Cost</b>
Plate Fabrication and Installation	1	Lump Sum	\$10,000	\$10,000
Contingencies (15%)				\$1,500
Engineering (15%)				\$1,500
<b>Total</b>				<b>\$13,000</b>

Operation and maintenance of the principal spillway modification is expected to be minimal. Therefore, the annual cost associated with implementation of the modification is essentially debt service, which would result in an annual cost of \$1,218 per structure assuming an interest rate of 8.0 percent and a financing period of 25 years. The unit cost of recharge for average conditions (1934-1989) would be about \$4.89 per acre-feet for Site 11 and \$9.82 for Site 13A. Although the volume of recharge associated with each individual project is small, the low cost and ease of implementation results in an economical project.

**Table 5-2  
Recharge Enhancement Cost Summary**

<b>Flood Control Structure</b>	<b>Annual Cost</b>	<b>1934-89 Average Recharge (acft/yr)</b>	<b>1947-56 Drought Recharge (acft/yr)</b>	<b>Average Unit Cost of Recharge (\$/acft)</b>	<b>Drought Unit Cost of Recharge (\$/acft)</b>
Salado Creek Site 11	\$1,218	249	0	\$4.89	N/A
Salado Creek Site 13A	\$1,218	124	0	\$9.82	N/A
<b>Total</b>	<b>\$2,436</b>	<b>373</b>	<b>0</b>	<b>\$6.53</b>	<b>N/A</b>



## 6.0 SUMMARY

Modification of the principal spillways at existing flood control projects in the Guadalupe-San Antonio River Basin is a relatively low cost method for enhancement of recharge. The potential for recharge enhancement appears to be the greatest in the Salado Creek watershed as most of the principal spillways for these structures appear to have been sized without considering the effects of recharge within the reservoir pool. Modification of the principal spillways at existing flood control projects in the Comal River and Upper San Marcos River watersheds is not considered to be feasible due to the rate of recharge in the reservoir pool being included in sizing the principal spillway for those structures. Modification of the principal spillways at the two York Creek flood control projects on the Edwards Aquifer recharge zone is not recommended due to the lower design standard for these structures (Class A structures) and concerns about the overall hydraulic capacity to meet the TNRCC Hydrologic Criteria for Dams.

The results of this study indicate that an average of approximately 373 acre-feet of additional recharge could potentially be achieved by reducing the hydraulic capacity of the principal spillways at two structures (Site 11 and Site 13A) in the Salado Creek watershed. Including the rate of recharge in the reservoir pool area allows for the principal spillway discharge capacity to be reduced and still meet the NRCS 10-day drawdown design criteria for the structure. Overall, the cost for implementation is relatively low, resulting in average annual unit costs for recharge enhancement ranging from \$4.89 to \$9.82 per acre-foot. At these minimal unit costs, resolution of institutional and permitting issues associated with implementation is of primary importance so that the benefits of increased aquifer pumpage and/or springflow may be fully realized.

A monitoring system consisting of stage recorders is recommended for installation at the structures and on the stream channel flowing into the reservoir. The monitoring system should be capable of measuring reservoir stage and inflow for a series of storm events to quantify the actual recharge rates within the reservoir pool. Actual recharge rates in the reservoir pool are expected to be higher than the estimates developed in this study, which may result in further reduction of the principal spillway discharge capacity and a greater potential for recharge enhancement. Implementation of a data collection system at other potential sites such as

Salado Creek Sites 4, 5, 6, and 10 is also recommended to provide data for future assessment of the potential for modification of the principal spillways at those sites.

**Report 4**

**Edwards Aquifer  
Recharge Update**

**TRANS-TEXAS WATER PROGRAM  
WEST CENTRAL STUDY AREA**

**PHASE 2**

**MODIFICATION OF PRINCIPAL SPILLWAYS AT  
EXISTING FLOOD CONTROL PROJECTS FOR  
RECHARGE ENHANCEMENT**

**San Antonio River Authority  
San Antonio Water System  
Edwards Aquifer Authority  
Guadalupe-Blanco River Authority  
Lower Colorado River Authority  
Bexar Metropolitan Water District  
Nueces River Authority  
Canyon Lake Water Supply Corporation  
Bexar-Medina-Atascosa Counties WCID No. 1  
Texas Natural Resource Conservation Commission  
Texas Parks and Wildlife Department  
Texas Water Development Board**

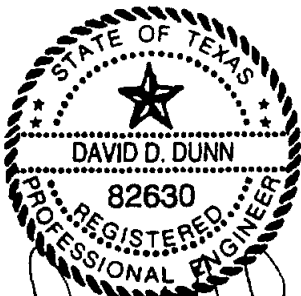

*David D. Dunn*  
3/25/98

**HDR**

HDR Engineering, Inc.

March 1998

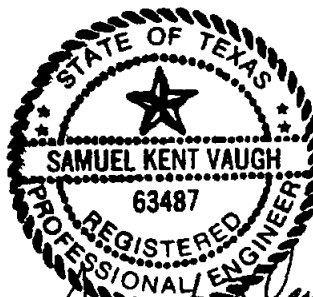

*Samuel Kent Vaughn*  
3/25/98

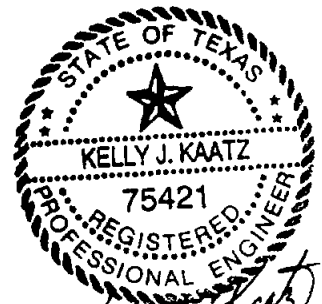

*Kelly J. Kaatz*  
3/25/98

**TRANS-TEXAS WATER PROGRAM  
WEST CENTRAL STUDY AREA**

**EDWARDS AQUIFER RECHARGE UPDATE**

**TABLE OF CONTENTS**

<b>Section</b>	<b>Page</b>
<b>1.0 INTRODUCTION.....</b>	<b>1-1</b>
<b>2.0 DATA COLLECTION AND REFINEMENT .....</b>	<b>2-1</b>
<b>3.0 RECHARGE SUMMARY AND COMPARISONS .....</b>	<b>3-1</b>
<b>3.1 Nueces River Basin .....</b>	<b>3-1</b>
<b>3.2 Guadalupe - San Antonio River Basin .....</b>	<b>3-3</b>
<b>3.3 General Comparisons .....</b>	<b>3-5</b>
<b>4.0 RECOMMENDATIONS.....</b>	<b>4-1</b>
 <b>APPENDICES</b>	
<b>A HISTORICAL EDWARDS AQUIFER RECHARGE ESTIMATES.....</b>	<b>A-1</b>

## LIST OF FIGURES

<b>Figure No.</b>		<b>Page</b>
1.0-1	Nueces River Basin Edwards Aquifer Recharge Basins.....	1-3
1.0-2	GSA River Basin Edwards Aquifer Recharge Basins .....	1-4
2.0-1	Reported Water Use Comparisons.....	2-2
3.1-1	Annual Edwards Aquifer Recharge Comparisons Nueces River Basin.....	3-2
3.2-1	Annual Edwards Aquifer Recharge Comparisons GSA River Basin .....	3-4
3.3-1	Geographical Comparison of Edwards Aquifer Recharge by Recharge Basin.....	3-7
3.3-2	Long Term Edwards Aquifer Recharge Comparisons.....	3-8
3.3-3	Geographical Comparison of Edwards Aquifer Recharge by River Basin.....	3-10

## LIST OF TABLES

<b>Table No.</b>		<b>Page</b>
3.3-1	Summary of Average Historical Edwards Aquifer Recharge by Basin (1934-96).....	3-6

## 1.0 INTRODUCTION AND BACKGROUND

The 1990-96 historical period was one of extremes with respect to fluctuations in pumpage, water levels, and springflows associated with the Edwards Aquifer. Coming out of a drought in the late 1980's which resulted in record high annual pumpage (543,000 acft) in 1989, the Edwards Aquifer rose to a record high level of about 703 ft-msl recorded at the Bexar County Monitoring Well (J-17) in June, 1992 when pumpage fell to the lowest annual rate (327,000 acft) since 1973. Then, another drought cycle ensued resulting in significantly reduced springflows and severe water use restrictions during the summer of 1996. In addition to improved estimates of pumpage, the extremes experienced by the aquifer make the first half of the 1990's an excellent period for potential use in calibration of Edwards Aquifer models such as the GWSIM4 model developed by the Texas Water Development Board (TWDB).<sup>1</sup>

The TWDB staff is, in fact, engaged in recalibration and enhancement of the GWSIM4 model which has been applied extensively in the Trans-Texas Water Program, Edwards Aquifer litigation, and numerous technical and planning studies. This recalibration effort has been prompted by the availability of improved geological mapping in Hays, Comal, and Bexar Counties, installation of a precipitation (and streamflow) gaging network in the Edwards outcrop area, completion of aquifer divide studies, and ongoing water balance studies for Medina Lake and the Guadalupe River. In addition, estimates of historical Edwards Aquifer recharge have been developed by HDR Engineering, Inc. (HDR) in the course of studies sponsored by the Edwards Underground Water District<sup>2</sup> and Nueces River Authority.<sup>3</sup> Based on the 1934-89 historical period, HDR estimates differ significantly from those published by the U.S. Geological Survey<sup>4</sup> (USGS) in terms of both geographical and temporal distribution.

As the TWDB has expressed an interest in using the most recent historical data available in the recalibration effort and regional sponsors have expressed their concurrence, HDR has

---

<sup>1</sup> TWDB, "Ground-water Resources and Model Applications for the Edwards (Balcones Fault Zone) Aquifer in the San Antonio Region," Report 239, October, 1979.

<sup>2</sup> HDR, "Guadalupe - San Antonio River Basin Recharge Enhancement Study," Vol. 2, Edwards Underground Water District, September, 1993.

<sup>3</sup> HDR, "Nueces River Basin Regional Water Supply Planning Study, Phase I," Vol. 2, Nueces River Authority, et al., May, 1991.

<sup>4</sup> USGS, "Recharge to and Discharge from the Edwards Aquifer in the San Antonio Area, Texas, 1996," <http://txwww.cr.usgs.gov/reports/info/97/recharge1/index.html>, April, 1997.

updated its recharge estimates to include the 1990-96 historical period and will provide them to the TWDB for consideration as an alternative to published USGS estimates. Estimates of Edwards Aquifer recharge have been developed for four recharge basins in the Nueces River Basin (Figure 1.0-1) and five recharge basins in the Guadalupe - San Antonio River Basin (Figure 1.0-2) for the 1990-96 historical period. The following sections of this report detail the data collection and refinement efforts prerequisite to recharge calculation, summarize the resulting estimates of Edwards Aquifer recharge in both historical and geographical contexts, and provide comparisons to published USGS estimates. Recommendations regarding opportunities for improvement of recharge estimates are included in Section 4.



**LEGEND**

- RECHARGE AREA
- USGS STREAMGAGE
- RECHARGE BASIN BOUNDARY
- STREAMGAGE BASIN BOUNDARY
  
- RECHARGE BASINS
- ① NUECES - WEST NUECES
- ② FRIO - DRY FRIO
- ③ SABINAL
- ④ AREA BETWEEN SABINAL AND MEDINA RIVER
  
- UNGAGED AREAS
- A LEONA RIVER
- B HACKBERRY AND BLANCO CREEKS
- C LITTLE BLANCO AND NOLTON CREEKS
- D RANCHERO CREEK
- E PARKERS AND LIVE OAK CREEKS
- F AREA BETWEEN HONDO CREEK AND MEDINA RIVER
- F-1 ABOVE RECHARGE ZONE
- F-2 RECHARGE ZONE - VERDE CREEK
- F-3 RECHARGE ZONE - OTHER

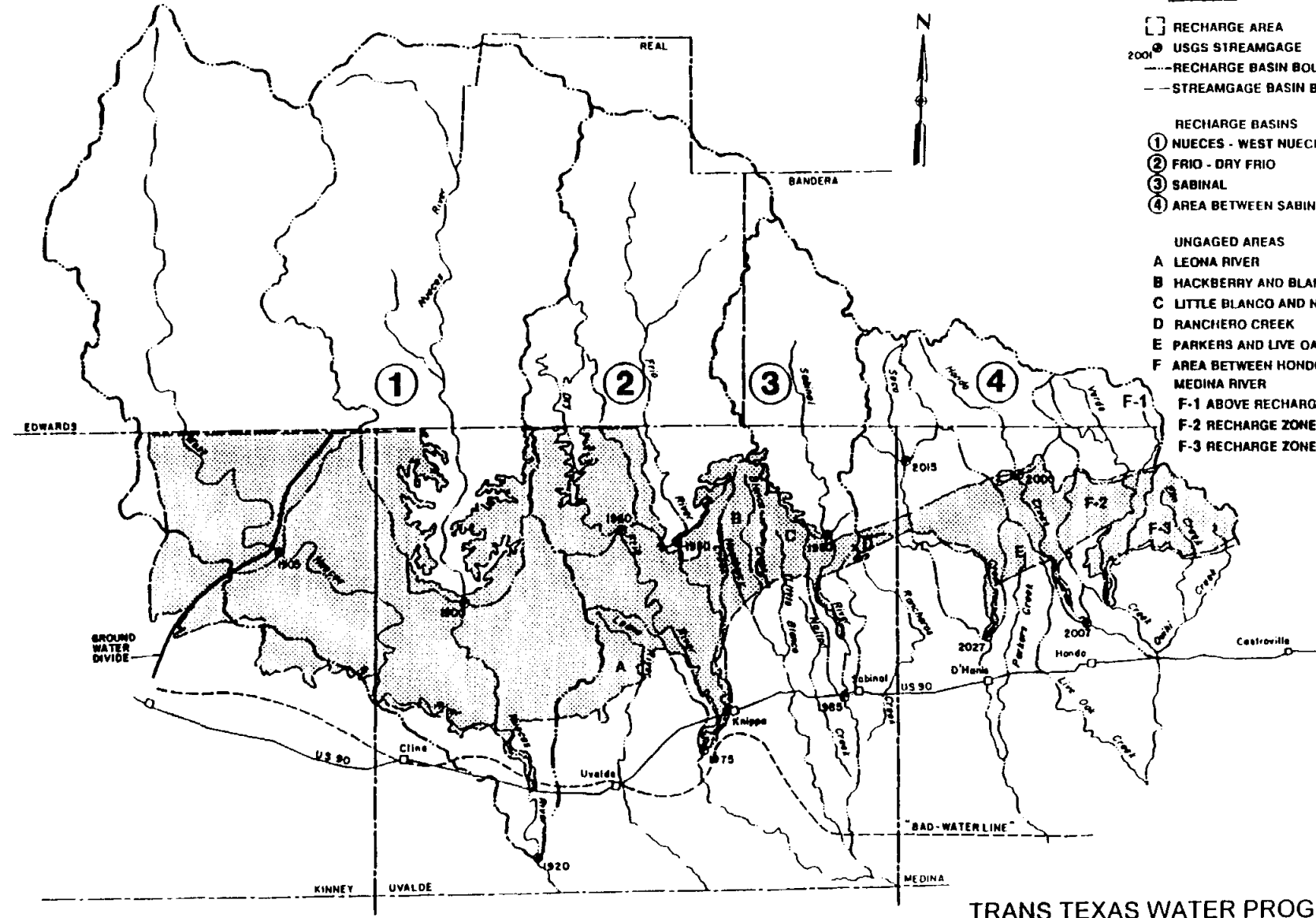

APPROXIMATE SCALE



EDWARDS AQUIFER  
RECHARGE UPDATE



HDR Engineering, Inc.

TRANS TEXAS WATER PROGRAM /  
WEST CENTRAL STUDY AREA

**NUECES RIVER BASIN  
EDWARDS AQUIFER  
RECHARGE BASINS**

FIGURE 1.0-1

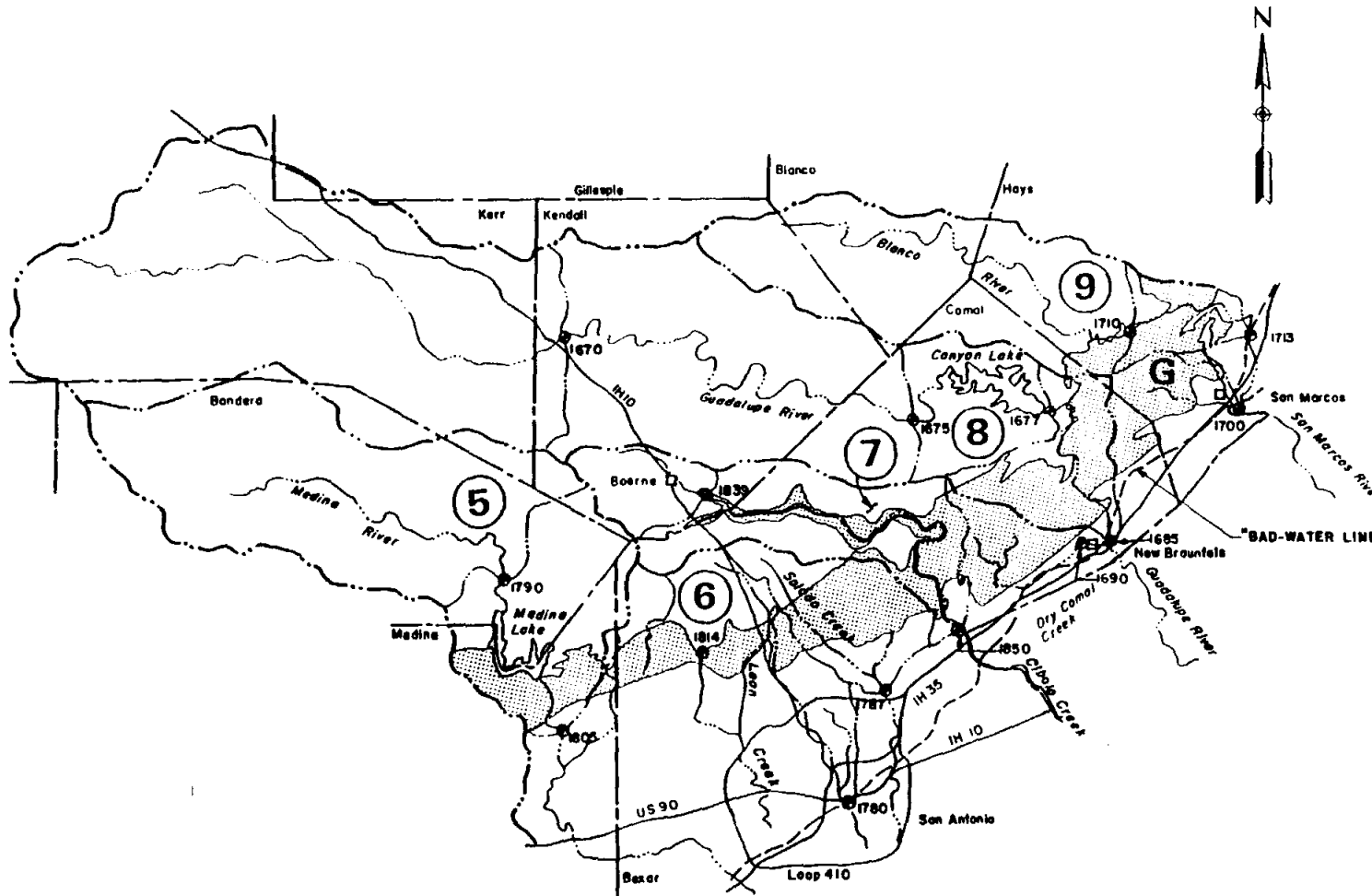

**LEGEND**

- RECHARGE AREA
- 1710  USGS STREAMGAGE
- RECHARGE BASIN BOUNDARY
- STREAMGAGE BASIN BOUNDARY

**RECHARGE BASINS**

- 5 MEDINA RIVER
- 6 AREA BETWEEN MEDINA AND CIBOLO
- 7 CIBOLO AND DRY COMAL
- 8 GUADALUPE
- 9 BLANCO

**UNGAGED AREAS**

- G SINK, PURGATORY, YORK AND ALLIGATOR CREEKS

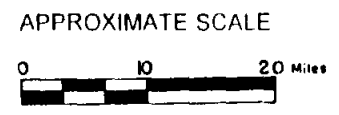

EDWARDS AQUIFER  
RECHARGE UPDATE



HDR Engineering, Inc.

TRANS TEXAS WATER PROGRAM /  
WEST CENTRAL STUDY AREA

**GSA RIVER BASIN  
EDWARDS AQUIFER  
RECHARGE BASINS**

FIGURE 1.0-2

## 2.0 DATA COLLECTION AND REFINEMENT

The first step in the process of Edwards Aquifer recharge calculation was the collection of pertinent monthly hydrologic data sets including precipitation, streamflow, reservoir contents, surface water use, treated effluent volumes, and net evaporation for the 1990-96 historical period. Pertinent hydrologic data sets collected and primary sources are summarized as follows:

- Precipitation — National Weather Service, USGS, TWDB
- Streamflow — USGS
- Reservoir Contents — USGS, Bexar-Medina-Atascosa Counties WCID#1 (BMA), Blackwell, Carter & Associates, Inc. (BCA)
- Surface Water Use — Texas Natural Resource Conservation Commission (TNRCC, Office of the Water Master), USGS, BMA, BCA
- Treated Effluent Volumes — TNRCC
- Net Evaporation — BCA

Supplementary hydrologic data collected also includes monthly estimates of recharge for existing enhancement projects provided by the Edwards Aquifer Authority (EAA) and annual historical recharge by basin available from the USGS.

Once all pertinent information was in hand and prior to initiating recharge calculations, data sets from various sources were assembled and refined through review for consistency, estimation of unavailable data, areal precipitation computation, streamflow naturalization, and potential runoff calculation. Only one concern was noted regarding consistency of data for the 1990-96 period as compared with earlier years. This concern is associated with reported surface water use data provided by the TNRCC Water Master and its consistency with earlier data which was obtained from the TNRCC (prior to full implementation of the Water Master program). Figure 2.0-1 shows reported surface water use for four selected stream segments upstream of the Edwards Aquifer recharge zone for the 1980-96 period. While the apparent inconsistencies shown in Figure 2.0-1 may appear rather alarming, the potential effect on long-term average recharge estimates is minimal, so the surface water use data provided by the TNRCC Water Master was used directly. Areal precipitation computation, streamflow naturalization, and potential runoff calculation were all accomplished using techniques described in referenced studies.<sup>1,2</sup>

---

<sup>1</sup> HDR, Op. Cit., September, 1993.

<sup>2</sup> HDR, Op. Cit., May, 1991.

**BLANCO RIVER ABOVE WIMBERLEY**

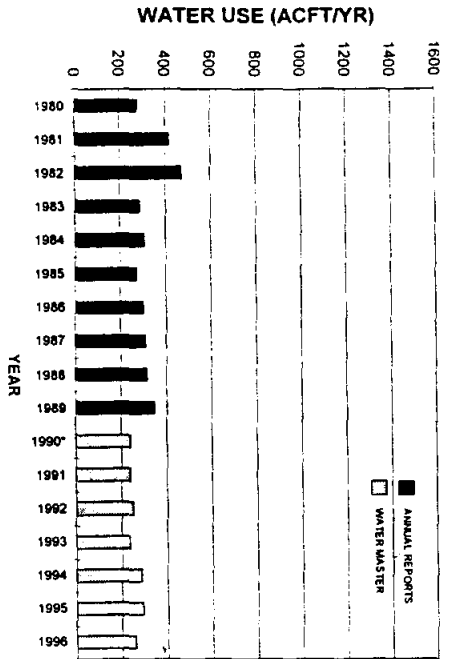

**NUECES RIVER ABOVE LAGUNA**

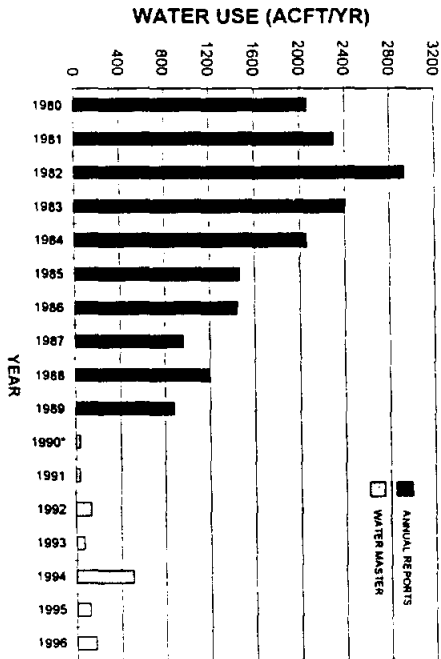

**MEDINA RIVER ABOVE PIPE CREEK**

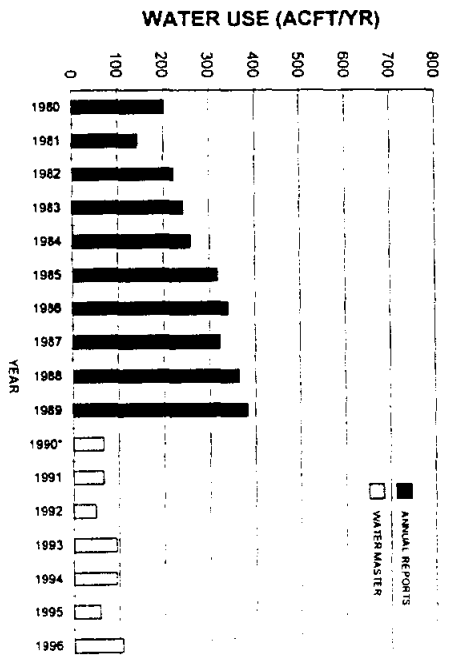

**FRIO RIVER ABOVE CONCAN**

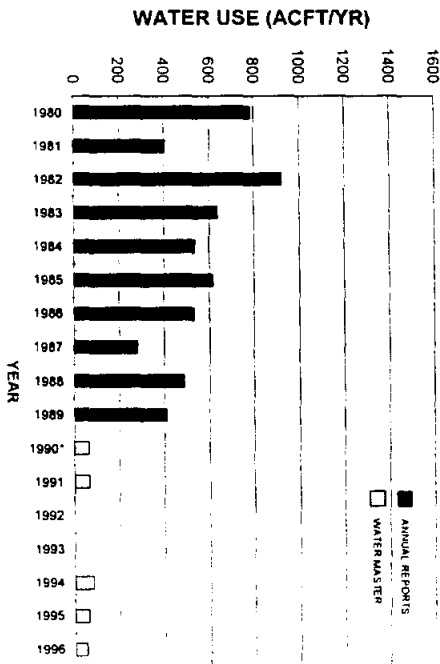

\* No records of use available from TNRCC Water Master's office.  
 Water use assumed equal to that reported in 1991.

EDWARDS AQUIFER  
 RECHARGE UPDATE



HDR Engineering, Inc.

TRANS TEXAS WATER PROGRAM /  
 WEST CENTRAL STUDY AREA  
**REPORTED WATER USE  
 COMPARISONS**

FIGURE 2.0-1

### 3.0 RECHARGE SUMMARY AND COMPARISONS

Methodologies previously developed and applied by HDR in the computation of Edwards Aquifer recharge on a monthly timestep are described at length in studies prepared under the sponsorship of the Edwards Underground Water District<sup>1</sup> and the Nueces River Authority.<sup>2</sup> For consistency with these referenced studies, recharge estimates for the 1990-96 period have been computed using methodologies and assumptions identical to those previously applied. Resulting recharge estimates are summarized by major river basin in the following subsections and compared to those estimates prepared by the USGS. A comprehensive summary of historical Edwards Aquifer recharge estimates by river and recharge basin for the full 1934-96 historical period is included as Appendix A.

#### 3.1 Nueces River Basin

The Nueces River Basin has been subdivided into four recharge basins identified in Figure 1.0-1 as the Nueces / West Nueces, Frio / Dry Frio, Sabinal, and the Area Between Sabinal and Medina Basin (which includes Seco, Hondo, and Verde Creek as well as several smaller tributary streams). In addition to naturally occurring recharge in the Nueces River Basin, the EAA (formerly EUWD) has constructed projects located on Seco, Parkers, and Verde Creek which serve to enhance recharge. Recharge associated with these projects was provided by the EAA for inclusion in the recharge basin summaries presented herein.

Figure 3.1-1 summarizes both HDR and USGS estimates of Edwards Aquifer recharge for each recharge basin within the Nueces River Basin for the 1990-96 historical period. Based on the full 1934-96 historical period, record high annual recharge volumes (432,412 acft) for the Sabinal River and the Seco, Hondo, and Verde Creek basins occurred in 1992 while a record low annual recharge volume of only 1,894 acft was computed for the Hondo Creek basin in 1996. It is readily apparent in Figure 3.1-1 that USGS recharge estimates in the wettest years are sometimes more than double those computed by HDR. There are several fundamental differences between certain recharge calculation procedures employed by the USGS and HDR,

---

<sup>1</sup> HDR, Op. Cit., September, 1993.

<sup>2</sup> HDR, Op. Cit., May, 1991.

NUECES/WEST NUECES BASIN

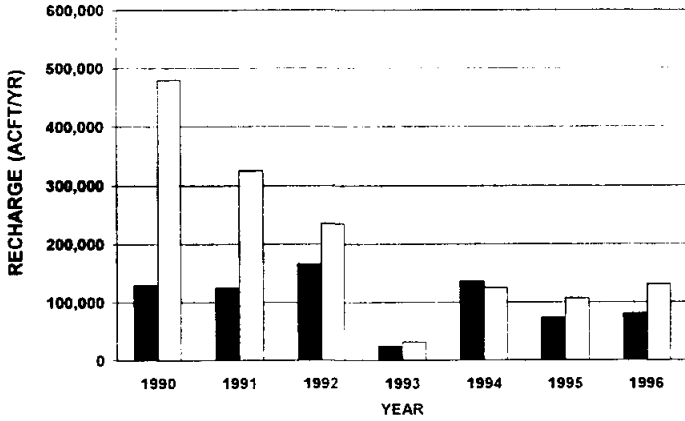

FRIO/DRY FRIO BASIN

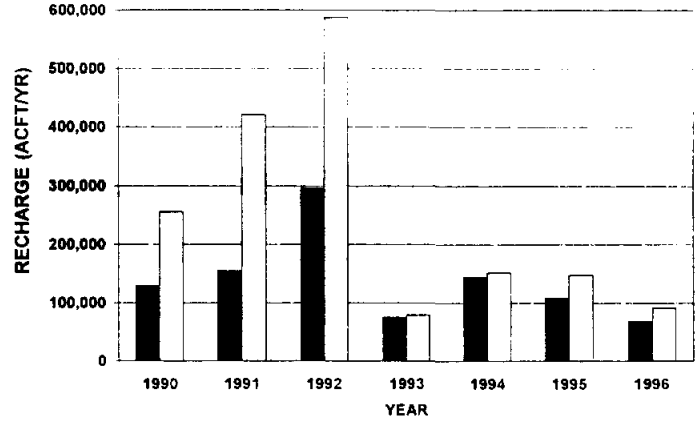

SABINAL BASIN

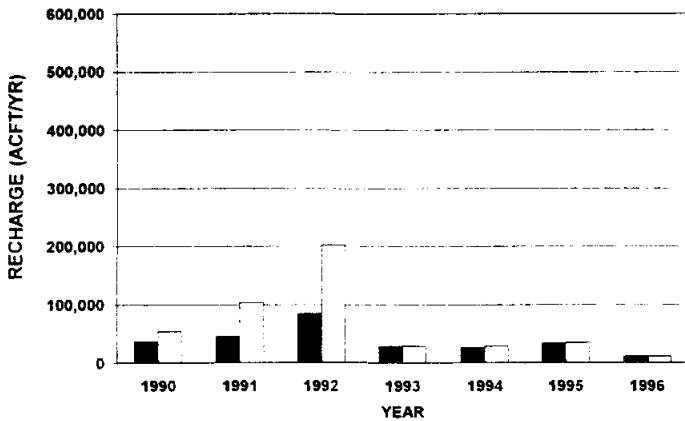

AREA BETWEEN SABINAL AND MEDINA BASIN

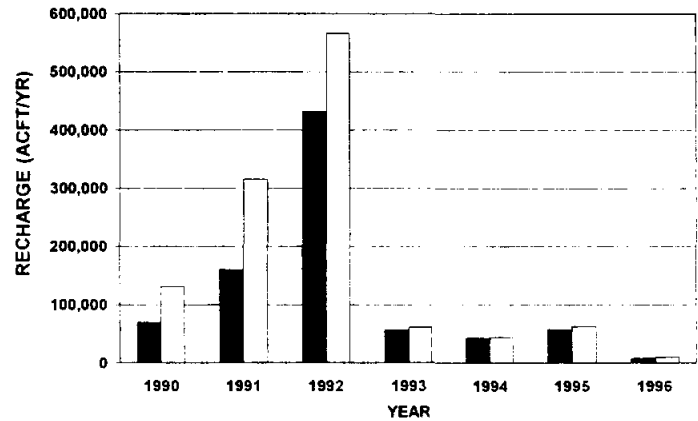

**LEGEND**

- HDR
- USGS



HDR Engineering, Inc.

EDWARDS AQUIFER  
RECHARGE UPDATE

TRANS TEXAS WATER PROGRAM /  
WEST CENTRAL STUDY AREA

**ANNUAL EDWARDS AQUIFER  
RECHARGE COMPARISONS  
NUECES RIVER BASIN**

FIGURE 3.1-1

such as areal precipitation calculation, potential runoff estimation, and accounting for reported water rights diversions. The extreme difference in wet year estimates, however, is believed to be associated with the USGS application of "base flow curves" relating base flow upstream of the Edwards Aquifer outcrop to storage in the Edwards Plateau Aquifer contributing to base flow.<sup>3</sup>

### **3.2 Guadalupe - San Antonio River Basin**

The Guadalupe - San Antonio River Basin has been subdivided into five recharge basins identified in Figure 1.0-2 as the Medina River, Area Between Medina and Cibolo (which includes San Geronimo, Helotes, Leon, and Salado Creek as well as several smaller tributary streams), Cibolo and Dry Comal, Guadalupe, and Blanco. In addition to naturally occurring recharge in the Guadalupe - San Antonio River Basin, the EAA has constructed one recharge project located on San Geronimo Creek and the Natural Resources Conservation Service (formerly Soil Conservation Service) has constructed numerous Flood Retardation Structures (FRS) in the Salado, Dry Comal, and Upper San Marcos basins which serve to enhance recharge. Recharge associated with the San Geronimo project was provided by the EAA for inclusion in the recharge basin summaries presented herein. Estimates of historical recharge enhancement associated with the FRS were computed by HDR using methodologies summarized in a previous study.<sup>4</sup>

Figure 3.2-1 summarizes both HDR and USGS estimates of Edwards Aquifer recharge for each recharge basin within the Guadalupe - San Antonio River Basin for the 1990-96 historical period. Based on the full 1934-96 historical period, record high annual recharge amounts for the Upper San Marcos River, Salado Creek, and combined Cibolo and Dry Comal Creek basins occurred in 1992. With the exceptions of the Medina / Diversion Lake System and the Guadalupe Basin, it is apparent in Figure 3.2-1 that HDR recharge estimates generally exceed those prepared by the USGS. This is likely due to the selection of different partner areas for estimating potential runoff from the areas in which the Edwards formation outcrops. Again, the marked difference in Blanco River recharge estimates for 1992 (which was the wettest year

---

<sup>3</sup> USGS, "Method of Estimating Natural Recharge to the Edwards Aquifer in the San Antonio Area, Texas." Water Resources Investigations 78-10, April, 1978.

<sup>4</sup> HDR, Op. Cit., September, 1993.

MEDINA /DIVERSION LAKE SYSTEM

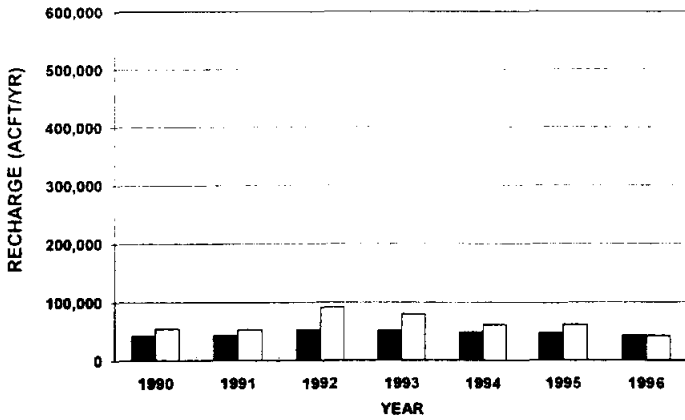

AREA BETWEEN MEDINA LAKE AND CIBOLO BASIN

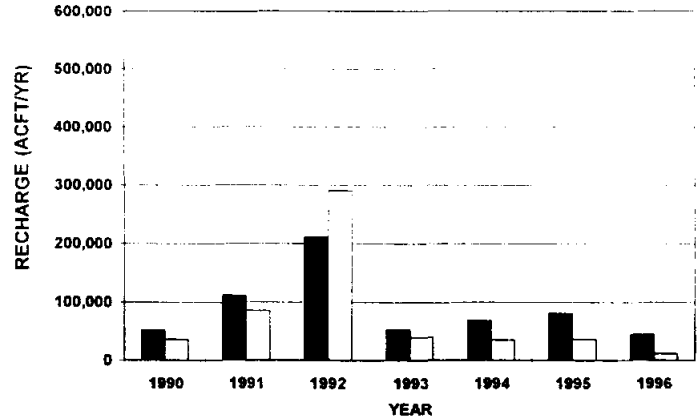

CIBOLO/DRY COMAL BASIN

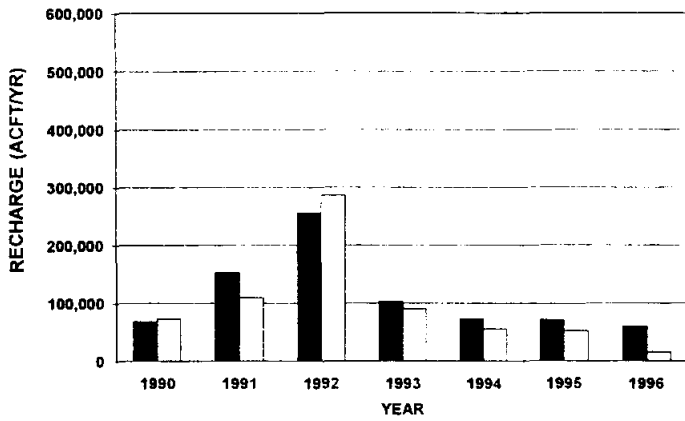

GUADALUPE BASIN

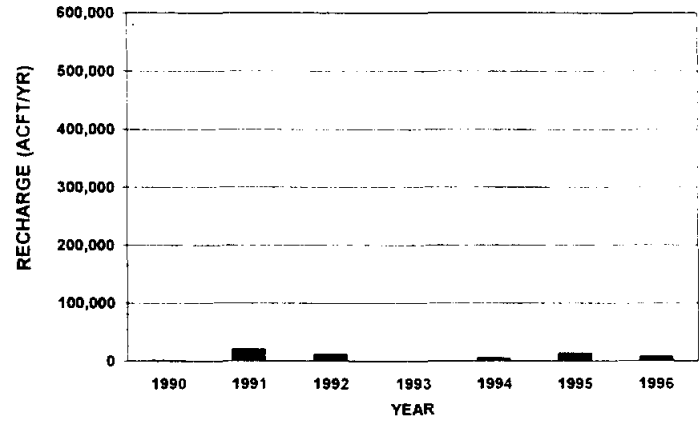

BLANCO BASIN

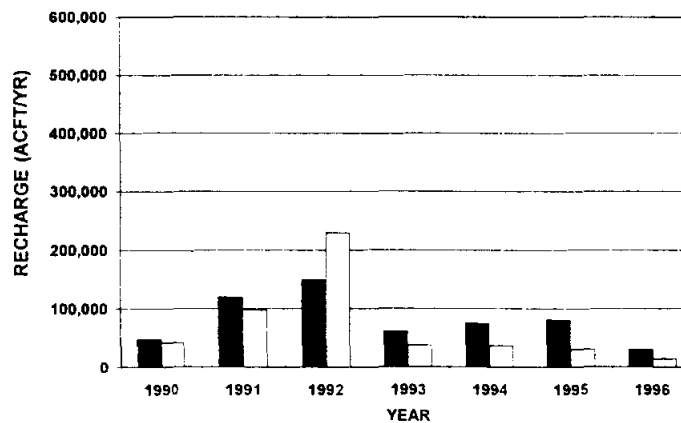

LEGEND

- HDR
- USGS

TRANS TEXAS WATER PROGRAM /  
WEST CENTRAL STUDY AREA

ANNUAL EDWARDS AQUIFER  
RECHARGE COMPARISONS  
GSA RIVER BASIN



HDR Engineering, Inc.

EDWARDS AQUIFER  
RECHARGE UPDATE

FIGURE 3.2-1



during the 1990-96 period) is likely explained by the USGS application of a base flow curve in their computation procedure.

Both the USGS and HDR estimates of annual recharge in the Medina / Diversion Lake System were computed using curves relating reservoir storage (or water surface elevation) to recharge rate. Applicable curves, however, were obtained from different sources. The USGS uses curves originally derived by Lowry<sup>5</sup> and HDR uses curves developed by Espey Huston & Associates.<sup>6</sup> It is likely that both sets of curves will soon be superseded by information in an upcoming USGS report on the Medina Lake Project which is presently under internal review.<sup>7</sup>

Also of note in Figure 3.2-1 is that HDR reports small annual estimates of Edwards Aquifer recharge occurring in the intervening Guadalupe River watershed between Canyon Reservoir and New Braunfels. The USGS reports that "the Guadalupe River crosses the infiltration area of the Edwards Aquifer, but does not contribute recharge in significant quantities."<sup>8</sup> HDR estimates indicate that annual recharge occurring in this area was as great as 20,363 acft during the 1990-96 period, but represents less than 2 percent of the long-term (1934-96) average recharge for the Edwards Aquifer in the Nueces and Guadalupe - San Antonio River Basins.

### 3.3 General Comparisons

As indicated in Appendix A, Edwards Aquifer recharge averaged about 652,700 acft/yr during the 1934-96 historical period. This is comparable to the published USGS estimate of 668,600 acft/yr which is about 2.4 percent greater. Table 3.3-1 and Figure 3.3-1 provide convenient summaries for geographical comparison of long-term average Edwards Aquifer recharge estimates developed by HDR and the USGS. Substantial differences, both in terms of volume and percentage, are readily apparent in specific recharge basins as only the Cibolo / Dry Comal recharge basin shows estimates within 10 percent of one another. In order to understand the differences between the HDR and USGS recharge estimates, basic methodologies and

---

<sup>5</sup> Lowry, R.L., "Recharge to the Edwards Ground Water Reservoir." San Antonio City Water Board, 1955.

<sup>6</sup> Espey, Huston & Associates, Inc., "Medina Lake Hydrology Study." Edwards Underground Water District, March, 1989.

<sup>7</sup> Lambert, R., Personal Communication. USGS, December, 1997.

<sup>8</sup> USGS, Op. Cit., April, 1978.

## 3.2 "Sustained Yield" Pumpage

The second management plan sets annual pumpage at a "sustained yield" rate so that minimum monthly flows at Comal Springs are not less than 60 cfs. The "sustained yield" is determined by adjusting the annual pumpage in the model on a trial and error basis until the model calculates flows at Comal Springs during the worst month of the drought to be 60 cfs. For the baseline conditions, model runs indicate the aquifer has a "sustained yield" pumpage of 270,000 ac-ft/yr. With springflow recirculation at rates of up to 200 cfs and 400 cfs, the "sustained yield" is 357,000 and 388,000 ac-ft/yr, respectively.

### 3.2.1 Ground Water

#### 3.2.1.1 Recirculated Springflow

Under this management plan and for purposes of this evaluation, all of the recirculated water for the rate of up to 200 cfs is recharged in Salado, Leon, and Helotes Creeks in Bexar County with each one receiving about a third of the water. When the maximum recirculation rate is 400 cfs, the first 200 cfs goes to the same Bexar County area with the remaining 200 cfs (or less) recharged in Seco, Parkers, Hondo, and Verde Creeks in Medina County. The actual rate of recirculated springflow (Figure 3.2-1) is dependent upon the availability of water downstream from the springs and ground water levels in an index well in the recharge area. If less water is available than the maximum recirculation rate, only the amount that is available is diverted to the recharge area. If the water level in the index well for a given recharge area rises above a specified elevation, then the diversion to that recharge area is turned 'OFF.' Later, if the water level declines below another specified elevation, then the diversion is turned back 'ON.'

For the recirculation rate of up to 200 cfs, the jagged breaks in the line below 200 cfs reflect conditions when there is not enough water in the Guadalupe River to provide a maximum diversion rate of 200 cfs. When there is an abrupt change from 200 cfs to 0 cfs and later back to 200 cfs, the water levels in the Hill Country index well in the Bexar County recharge area turned the diversion 'OFF' and then back 'ON.' Important characteristics of the graph are: (1) During the drought of the 1950s, there is a lack of water available for any springflow recirculation and

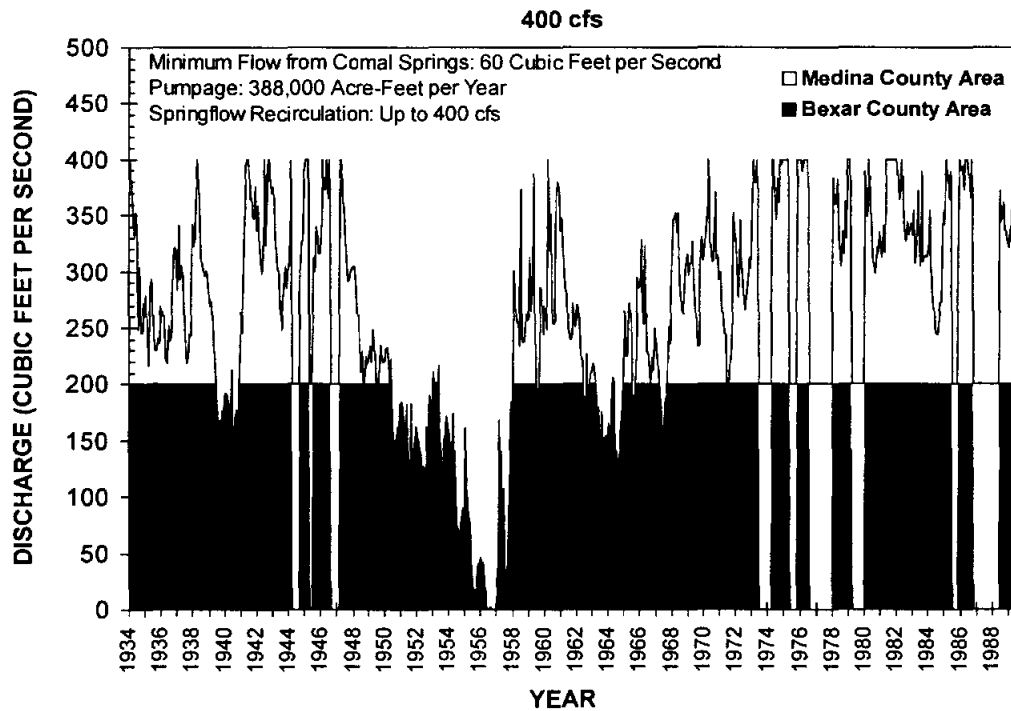
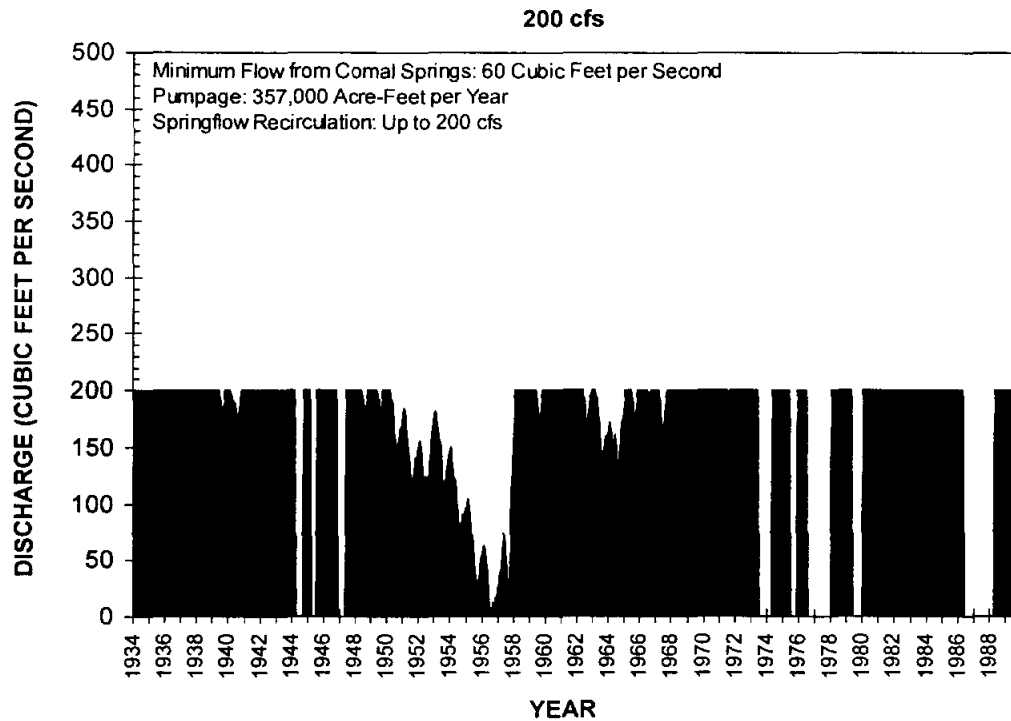

CONCEPTUAL EVALUATION OF  
 SPRINGFLOW RECIRCULATION

TRANS TEXAS WATER PROGRAM /  
 WEST CENTRAL STUDY AREA



HDR Engineering, Inc.

RECIRCULATED SPRINGFLOW  
 "SUSTAINED YIELD" PUMPAGE

FIGURE 3.2-1

(2) after 1973, the index well indicates that the aquifer was 'full' on several occasions. Because of these two constraints, an average of 161 cfs out of a possible 200 cfs was diverted for this run.

For the recirculation rate of up to 400 cfs, the jagged breaks in the plot again indicate a lack of water availability to meet the maximum diversion demand of 400 cfs. The graph shows that the maximum diversion rate is reached numerous times but the duration is always less than a year. The abrupt changes in the plots indicates the turning of the diversions 'OFF' and 'ON.' The diversions were turned 'OFF' in the Bexar County recharge area nine times but were not turn 'OFF' in the Medina County area. Because of these two constraints, an average of 257 cfs out of a possible 400 cfs was diverted. Of the 257 cfs, 160 cfs was recharged in Bexar County and 97 cfs was recharged in Medina County.

#### 3.2.1.2 Water Budget

As discussed earlier, the TWDB's representation of the Edwards Aquifer with the GWSIM4 ground water flow model maintains a water balance considering wells, springs, leakage to adjacent formations, and storage and for gains from natural recharge, recirculated recharge, and storage.

Changes between the baseline conditions and the two recirculation runs occurred in pumpage, springflow, leakage, recirculated springflow and change in storage (Figure 3.2-2). The "sustained yields" were calculated to be 270,000, 357,000, and 388,000 ac-ft/yr for no recirculation up to 200 cfs of recirculation (144,500 ac-ft/yr) and up to 400 cfs (maximum of 289,000 ac-ft/yr), respectively. On the average, natural recharge amounted to 642,000 ac-ft/yr. Recirculated recharge resulted in an increase of 18 and 29 percent in recharge to the Edwards Aquifer, respectively. For a recirculation rate of up to 200 cfs, about 75 percent of the recirculated springflow was pumped by wells and about 24 percent flowed from springs. When the maximum rate was increased to 400 cfs, the recirculated springflow being discharged by wells was 63 percent and the amount flowing from springs was 21 percent with most of the remainder going to increases in aquifer storage. In the first case, about 1 percent went into aquifer storage; however, in the second case, about 14 percent went into aquifer storage. These differences are attributed to a significant portion of the recirculated springflow under the 400 cfs scenario being recharged northwest of the Medina Lake and Diversion Lake fault complex. This

# WATER BALANCE OF THE EDWARDS AQUIFER, 1934-1989

Pumpage: Sustained Yield (270,000,  
357,000, and 388,000 Acre-Feet per Year)

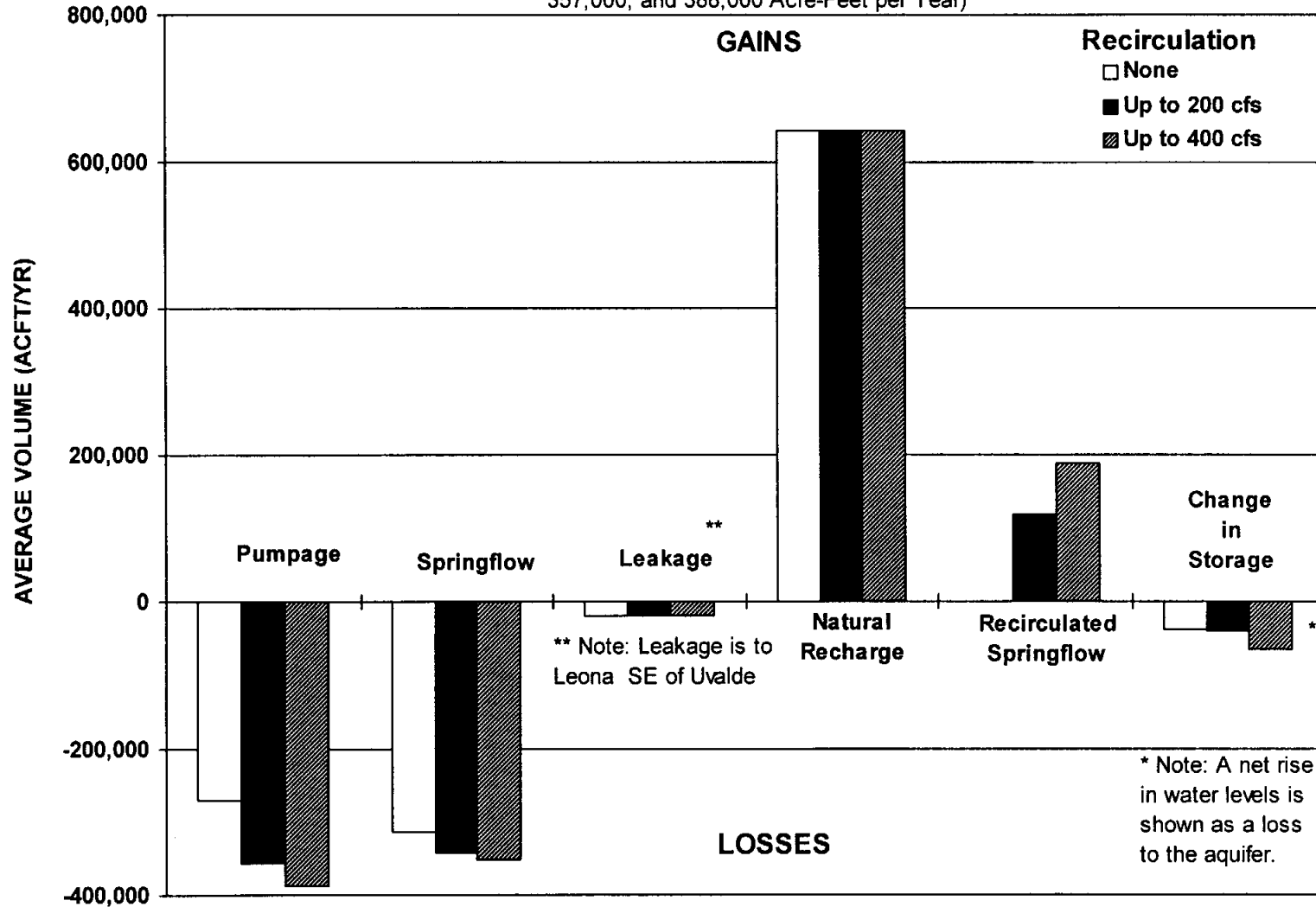

TRANS TEXAS WATER PROGRAM /  
WEST CENTRAL STUDY AREA

**WATER BUDGET**  
"SUSTAINED YIELD" PUMPAGE

CONCEPTUAL EVALUATION OF  
SPRINGFLOW RECIRCULATION



HDR Engineering, Inc.

FIGURE 3.2-2

causes water to be stored for a short time behind these faults and to take a very long flowpath before the water can cause a sufficient rise in water levels to influence springflow. The leakage rate in the Uvalde area into the Leona Formation ranges from about 18,000 to 20,000 ac-ft/yr for the three simulations. This water loss is believed to approximate discharges from Leona Springs.

#### 3.2.1.3 Comal Springs

Based on modeling results for the baseline condition of 270,000 ac-ft/yr Edwards Aquifer pumpage, the flow from Comal Springs from 1934 to 1989 averaged 287 cfs (Figure 3.2-3). With pumpage increased to 357,000 and 388,000 ac-ft/yr and associated recirculation rates of up to 200 and 400 cfs, the calculated flows from Comal Springs averaged 320 and 325 cfs. Under the “sustained yield” baseline pumping with no springflow recirculation test, the discharge from 1934 to 1946 is about 340 cfs. During the high flow conditions during 1973 to 1989, flows were often over 400 cfs and over 600 cfs once. During the 1950s drought, flows did not decline below the critical 60 cfs.

A comparison of the flow from Comal Springs between the baseline condition of no recirculation and recirculation rates of up to 200 and 400 cfs is shown in (Figure 3.2-3). Significant increases (enhancements) in springflow occurred from 1940-1955, 1962-1974 when the flows were about 50 cfs above the baseline conditions. The increase in springflow with the two recirculation scenarios during the 56-year test period was always within 20 cfs of each other. Neither was consistently greater than the other.

#### 3.2.1.4 Major Springs

Flow from the major springs of the Edwards Aquifer includes Comal, San Marcos, San Antonio, San Pedro, and Leona Springs. The average flow from all major springs during baseline conditions was 483 cfs and ranged from about 150 cfs in 1957 to over 900 in 1987. At Comal Springs, San Marcos Springs, and the combined flow of San Antonio and San Pedro Springs, the average flows were 325, 130, and 28 cfs, respectively. The model showed Leona Springs to be dry for all simulations; however, leakage rate of about 25 cfs in the Uvalde area may be considered to account for Leona Springs. However, this leakage was not added to the total of the five springs identified in the model.

**COMAL SPRINGS**

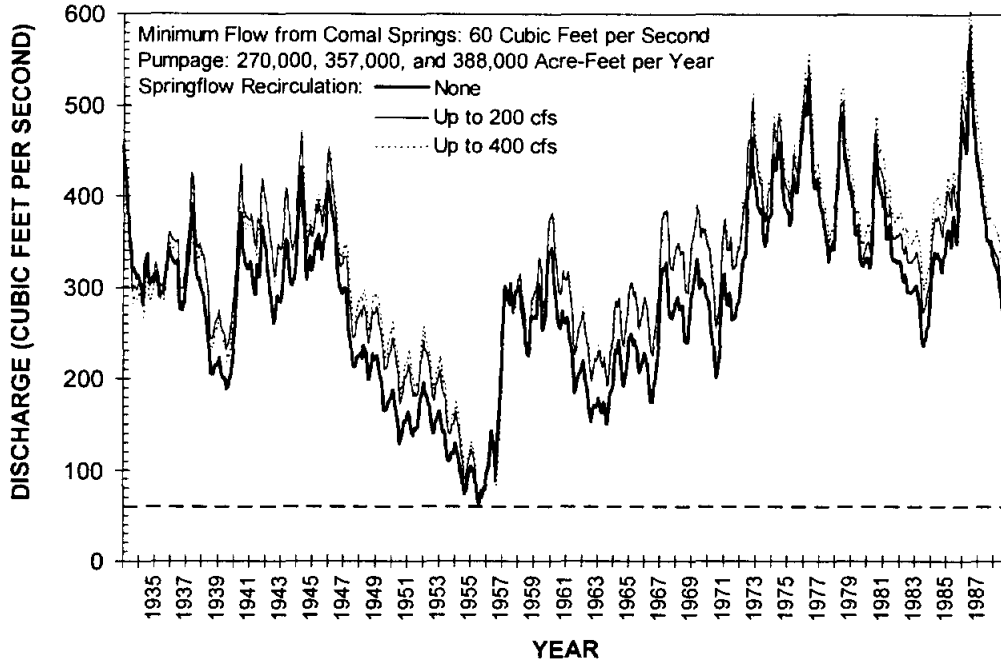

**COMAL SPRINGS - CHANGE IN FLOW**

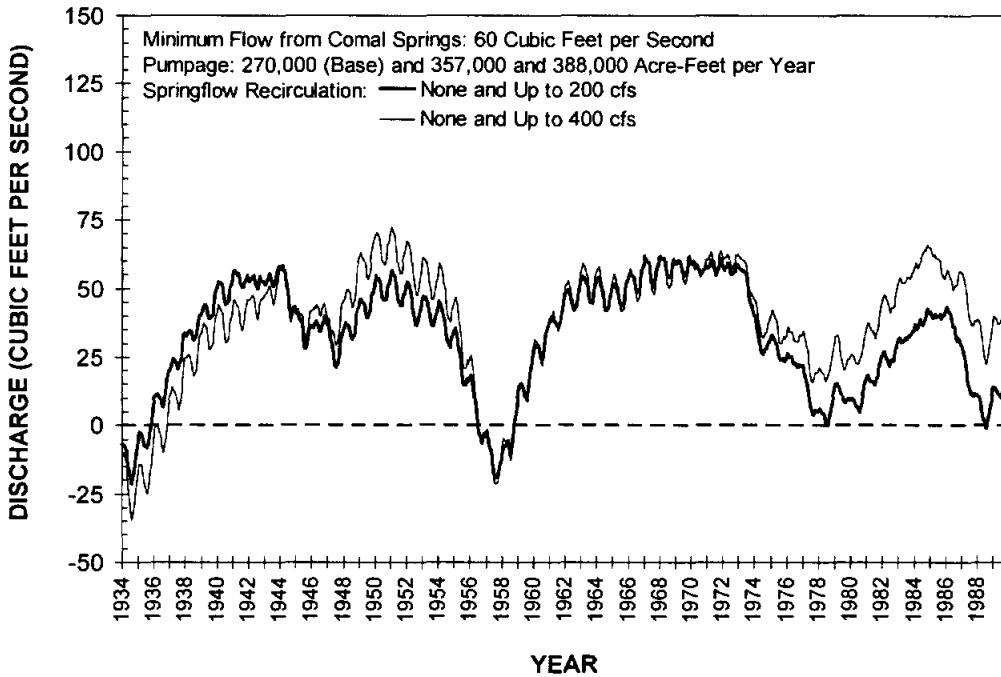

CONCEPTUAL EVALUATION OF  
 SPRINGFLOW RECIRCULATION

TRANS TEXAS WATER PROGRAM /  
 WEST CENTRAL STUDY AREA



HDR Engineering, Inc.

**COMPUTED FLOW FROM  
 COMAL SPRINGS**  
 "SUSTAINED YIELD" PUMPAGE

FIGURE 3.2-3

The impact of the 1950s drought is evident with declines in flow to less than 100 cfs for most of 3 years. The hydrograph shows rapid recoveries after the drought but they were short lived because of declines in the early 1960s. Beginning in the mid-1960s the springs recovery was moderate and steady until the early 1970s when recovery was again rapid. Since the early 1970s, flows appear to be substantially above normal except for short term droughts in 1984 and 1989.

The changes in the combined flow from all the springs show a pattern similar to Comal Springs (Figure 3.2-4). San Marcos Springs changed less than 5 cfs at any time. In contrast, flows from San Antonio and San Pedro Springs occur only during high water level conditions but only during the winter months when pumping is reduced. This flow caused the hydrograph showing changes in total springflow to take on a jagged pattern during the high water conditions in the early 1940s and after 1970. As with Comal Springs, turning the recirculation 'OFF' and 'ON' in northern Bexar County added to the erratic pattern. For the period from 1973 to 1989, the overall average flow from San Antonio and San Pedro Springs increased from an average of 9 cfs to 50 cfs for the 200 cfs rate, and from 9 to 75 cfs for the 400 cfs rate.

#### 3.2.1.5 Guadalupe River

A recirculation rate of up to 200 cfs was considered from Lake Dunlap, as described earlier. The springflow in the Guadalupe River at this location is equivalent to Comal Springs which is shown in (Figure 3.2-3). To show the impact of diversions on flows in the Guadalupe River at this location; the diversion rate calculated by the model is subtracted from the discharge of Comal Springs. This change in springflow in the Guadalupe River is shown in (Figure 3.2-5). The initial impact was the greatest, but tended to approach about 150 cfs in the mid-1940s, and early 1970s; but averaged 129 cfs. The sudden changes in springflows in the Guadalupe River that showed a net gain in flow occurred when the diversion was turned 'OFF' and back 'ON'. The graph shows the decrease in flows to become less severe during the low flow conditions of the 1950s drought. Overall, there was a reduction of 97 cfs in the Guadalupe River for the 200 cfs recirculation rate.

Diversion of the water for a recirculation rate of up to 400 cfs occurs from the Guadalupe River below the mouth of San Marcos River so that the diversion can include flow from Comal



**MAJOR SPRINGS**  
COMAL, SAN MARCOS, SAN ANTONIO, AND SAN PEDRO SPRINGS

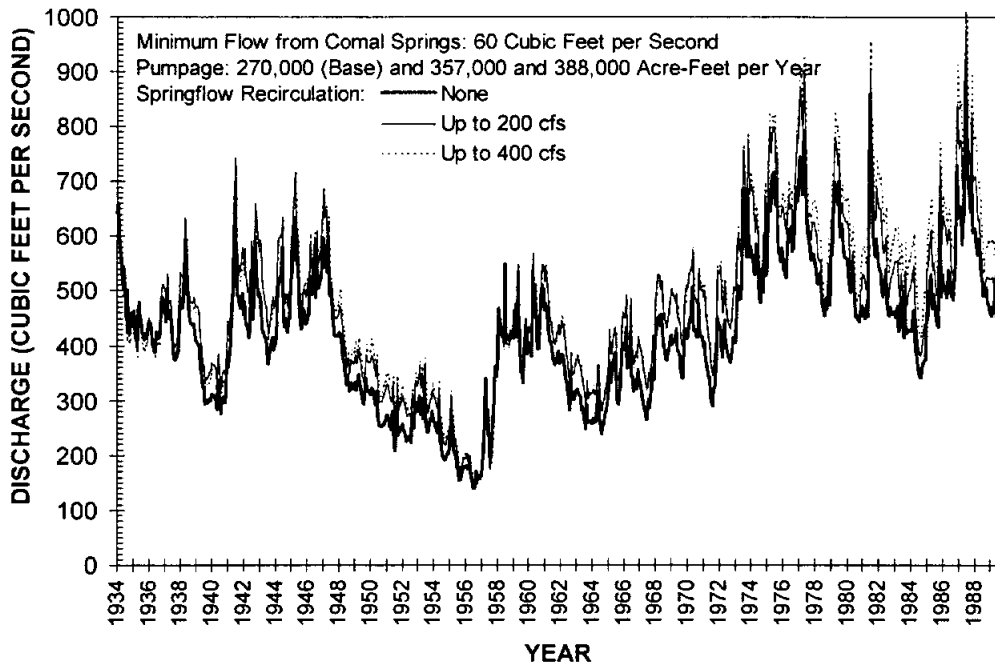

**MAJOR SPRINGS - CHANGE IN FLOW**

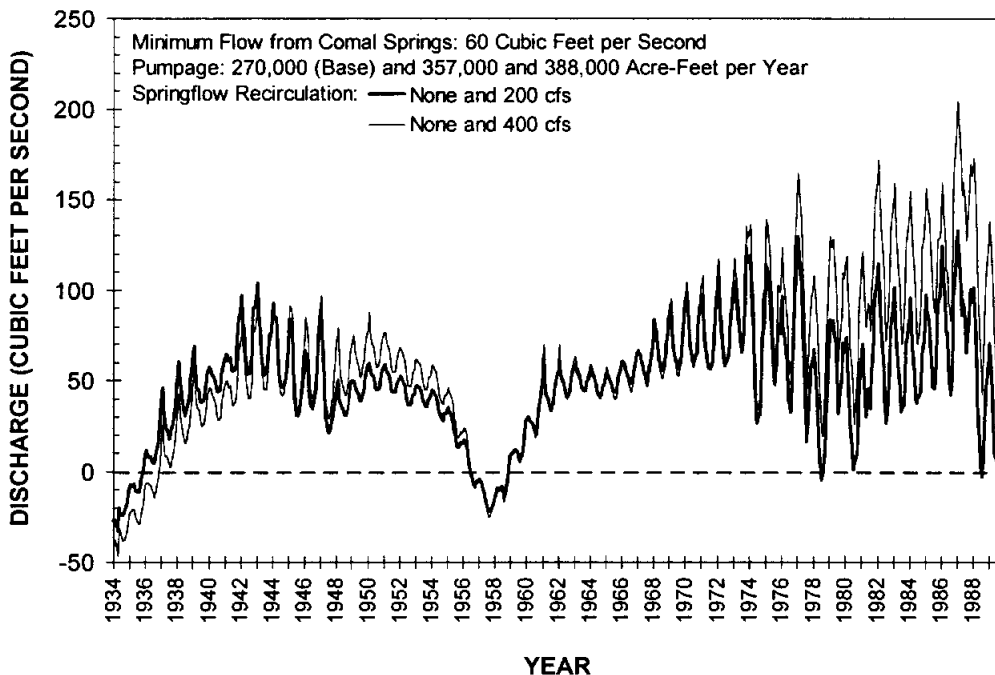

CONCEPTUAL EVALUATION OF  
SPRINGFLOW RECIRCULATION

TRANS TEXAS WATER PROGRAM /  
WEST CENTRAL STUDY AREA



HDR Engineering, Inc.

**COMPUTED FLOW FROM MAJOR  
SPRINGS OF EDWARDS AQUIFER  
"SUSTAINED YIELD" PUMPAGE**

FIGURE 3.2-4

**GUADALUPE RIVER  
CHANGE IN FLOW AFTER DIVERSION**

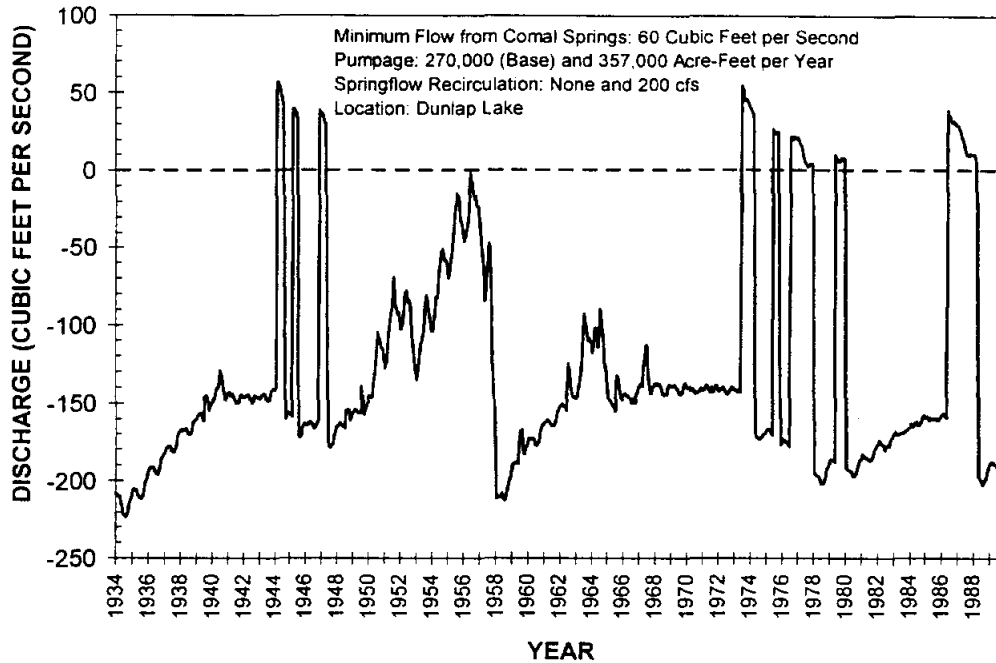

**GUADALUPE RIVER  
CHANGE IN FLOW AFTER DIVERSION**

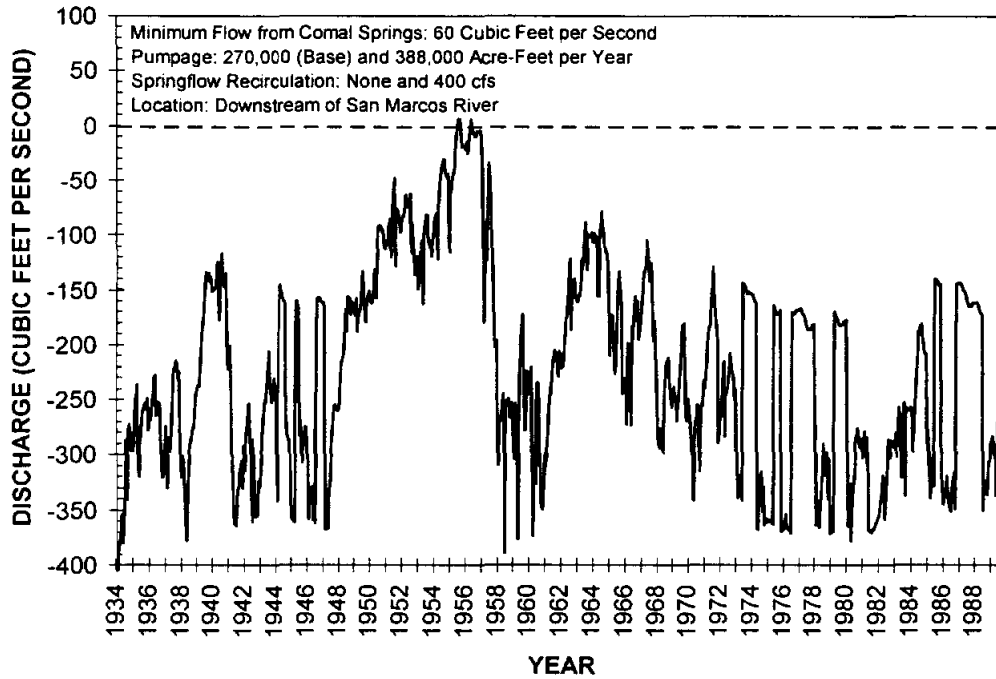

CONCEPTUAL EVALUATION OF  
 SPRINGFLOW RECIRCULATION

TRANS TEXAS WATER PROGRAM /  
 WEST CENTRAL STUDY AREA



HDR Engineering, Inc.

**COMPUTED CHANGE IN FLOW  
 GUADALUPE RIVER AFTER DIVERSION  
 "SUSTAINED YIELD" PUMPAGE**

FIGURE 3.2-5

Springs and San Marcos Springs. The average flow from the two springs was 456 cfs. The flow distribution for the 56-year test period is approximated by the major springs hydrograph shown in (Figure 3.2-4). To show the impact of the 400 cfs springflow recirculation diversion on flows in the Guadalupe River; the diversion rate as calculated by the model is subtracted from the combined discharge of Comal Springs and San Marcos Springs. As discussed earlier, the water available for diversion is limited to flows in excess of 160 cfs. The change in springflow in the Guadalupe River is shown in (Figure 3.2-5). As shown in the springflow recirculation graph (Figure 3.2-1), 400 cfs was available for diversion for only a small amount of the time. As a result, the average reduction from baseline conditions was 220 cfs. The square shaped spikes occurring after 1973 is in response to diversions being turned 'OFF' in both recharge areas.

#### 3.2.1.6 Water Levels

Water levels were calculated with the model at four locations. Two are in the outcrop areas; and, two are in the confined zone. The Hill Country monitoring well is located in the outcrop area of the Edwards Aquifer in northern Bexar County and was selected to be the index well for the Bexar County recharge area. The Seco Creek monitoring well is located northwest of the Medina Lake Fault and was selected to represent the water level conditions in the outcrop areas in the northwest part of the aquifer and in the Medina County recharge area. The J-17 well represents the San Antonio area; and, the Uvalde well represents the western part of the aquifer. Both are in the confined zone and are used as indices for declaring stages of drought management.

The calculated water levels in the Hill Country well averaged about 710 ft above mean sea level under conditions from 1934 to baseline 1947 and then declined until the cell nearly went dry at 660 ft in 1957. The model shows water level recoveries to about 725 ft in 1974 and to peak water levels of over 740 ft in 1977 and 1987 (Figure 3.2-6). For the two recirculation scenarios, the rise in water levels was very nearly the same. This is attributed to limiting recharge to 200 cfs in this area. During the test with springflow recirculation, water levels rose to an operating range of 745 and 750 ft which resulted in the recharge being turned 'OFF' and 'ON' several times in the 1940s and from 1973-1987.

### HILL COUNTRY WELL

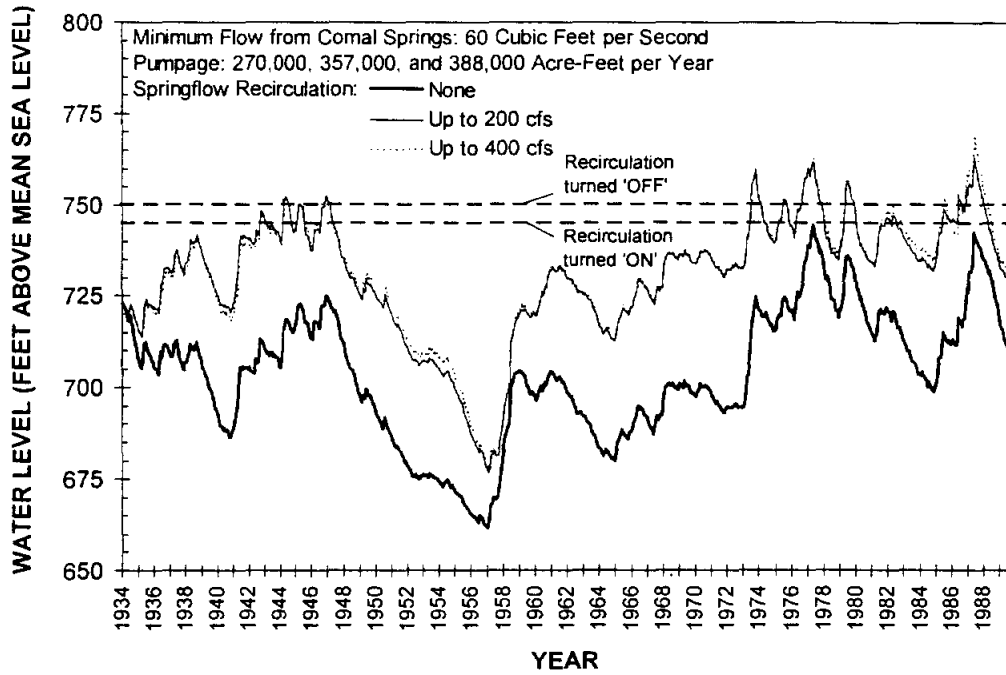

### SECO CREEK WELL

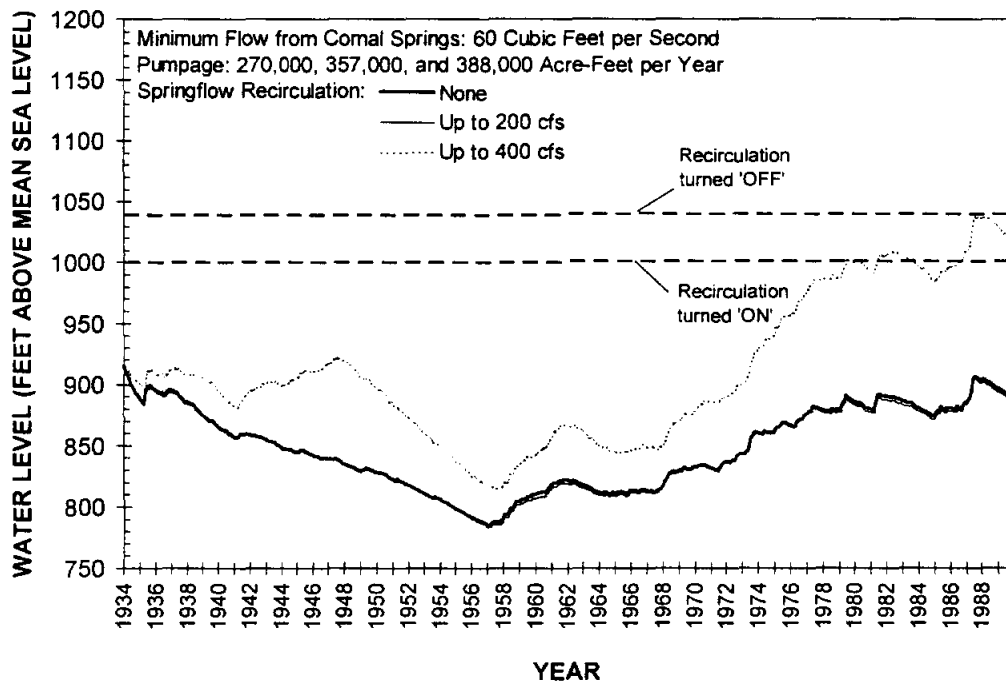

CONCEPTUAL EVALUATION OF  
 SPRINGFLOW RECIRCULATION

TRANS TEXAS WATER PROGRAM /  
 WEST CENTRAL STUDY AREA



HDR Engineering, Inc.

COMPUTED WATER LEVELS  
 AT INDEX WELLS  
 "SUSTAINED YIELD" PUMPAGE

FIGURE 3.2-6

The calculated water levels at the Seco Creek well location reflect a general decline of about 125 feet from 1934 to the worst part of the drought in 1957 and overall recovery to original water levels near the end of the 56-year simulation (Figure 3.2-6). For the 200 cfs recirculation rate, the water levels are almost identical to the baseline water levels, indicating recharge in the Bexar County area is effectively offsetting the increase in pumpage. However, for the recirculation rate of 400 cfs, the water levels increased about 80 ft higher than baseline conditions by 1947 and reached a maximum of 130 ft higher in 1987. The water levels never reached the elevation of 1040 ft at which point the recirculation would have been turned 'OFF.'

The calculated water levels at the J-17 well reflect the typical regional trend in ground water conditions with about normal water levels from 1934 to 1947, steady declines to about 600 ft by 1957, irregular recoveries until 1974 and generally higher than normal water levels after 1974 (Figure 3.2-7). Within the regional trends, there are annual pumping cycles where the summer pumping causes the water levels to decline about 20 ft below the winter recoveries. As with the Hill Country well, the combination of increased pumpage and recirculation produced similar rises in water levels above the baseline conditions until 1947. Afterwards, water levels with the 200 cfs recirculation rate increased water levels an average of about 4.1 ft while the 400 cfs scenario increased water levels an average of about 4.9 ft. Proposed drought management plans for the San Antonio area would impose pumpage reductions based on the J-17 well in the following stages: Stage I, 642-650 ft; Stage II, 636-642 ft; Stage III, 632-636 ft; Stage IV, 628-632; and Stage V, below 628. During the 1950s drought, water levels would have triggered restrictions for about a 9.9 year period for the baseline conditions. Both the 200 and 400 cfs recirculation rates would have reduced this to 5.5 years. The runs showed that the most severe restrictions would have been in place for part of one summer for the baseline conditions and parts of two summers with either of the recirculation plans.

The baseline water levels calculated by the model at the Uvalde monitoring well reflects the regional water level pattern with water levels at about 850 ft at the start of the period, declining to about 790 ft during the worst part of the drought, and recovering to about 860 ft at the end of the period (Figure 3.2-8). Each year, there is an annual cycle with a range of about 30 ft which appeared to be caused by local and regional pumping. For the 200 cfs recirculation plan, the increase in pumpage from 270,000 to 357,000 ac-ft/yr causes the water levels to be

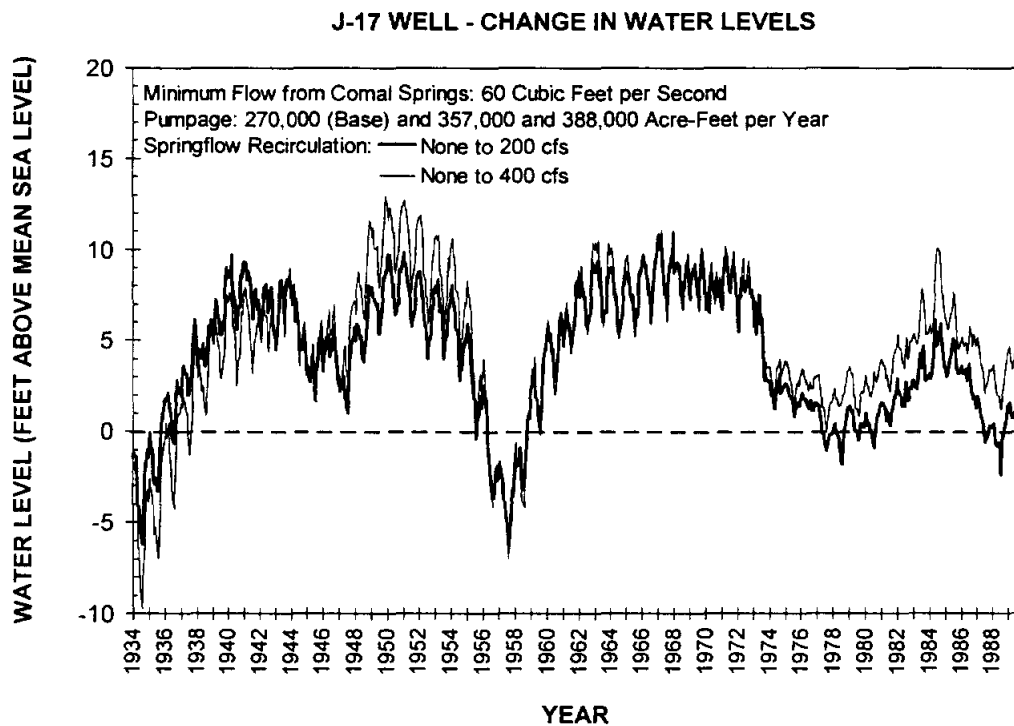
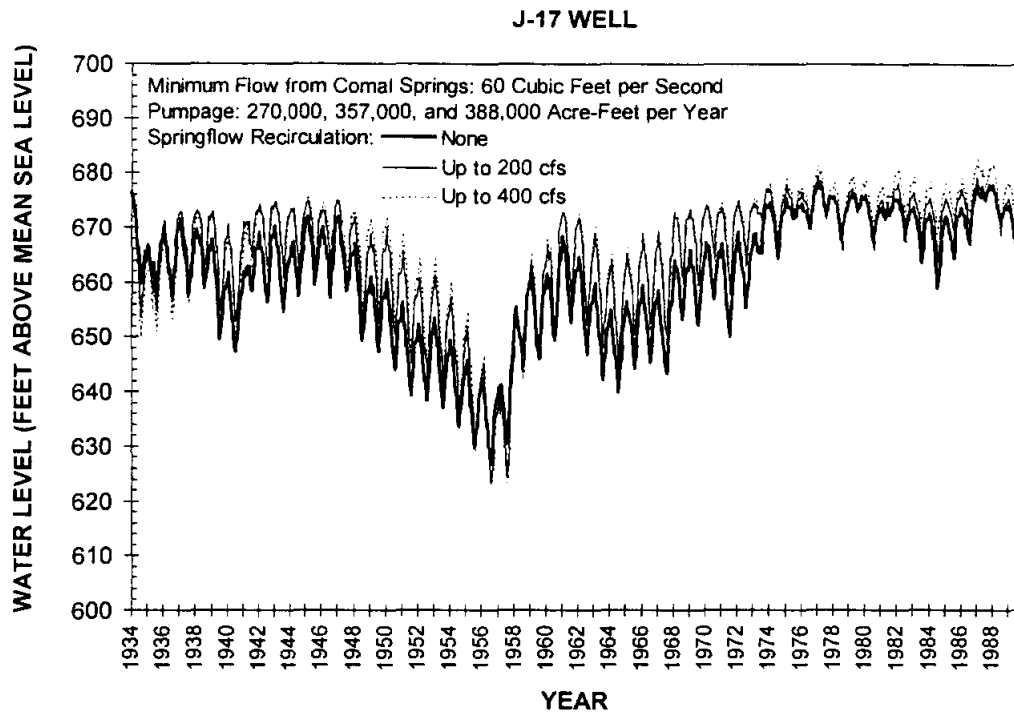

CONCEPTUAL EVALUATION OF  
 SPRINGFLOW RECIRCULATION

TRANS TEXAS WATER PROGRAM /  
 WEST CENTRAL STUDY AREA



HDR Engineering, Inc.

COMPUTED WATER LEVELS  
 AT J-17 INDEX WELL  
 "SUSTAINED YIELD" PUMPAGE

FIGURE 3.2-7

UVALDE WELL

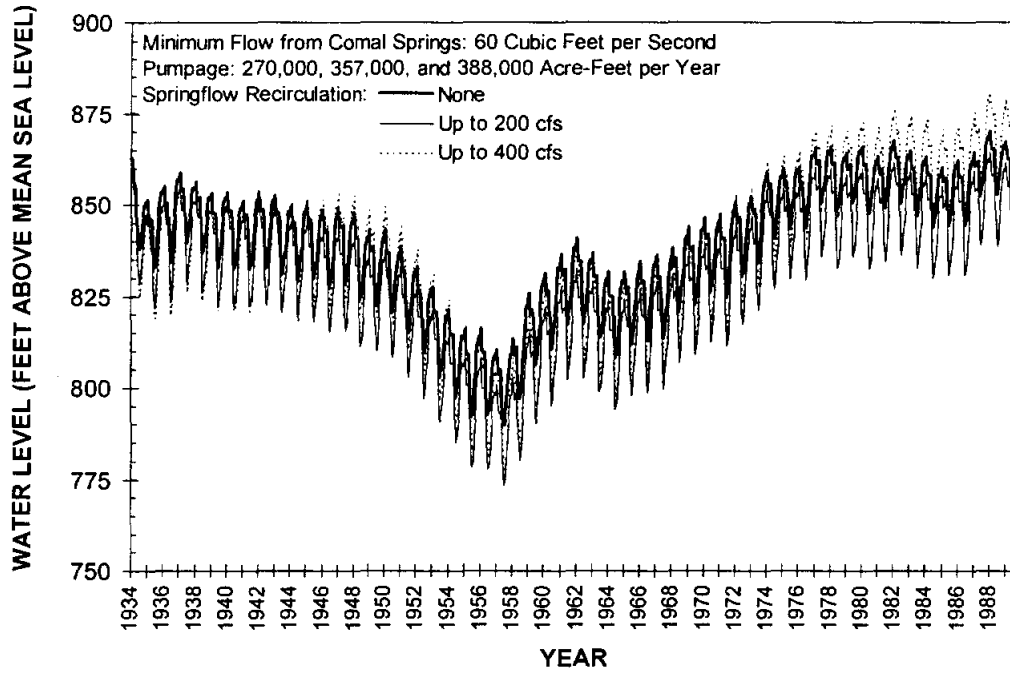

UVALDE WELL - CHANGE IN WATER LEVELS

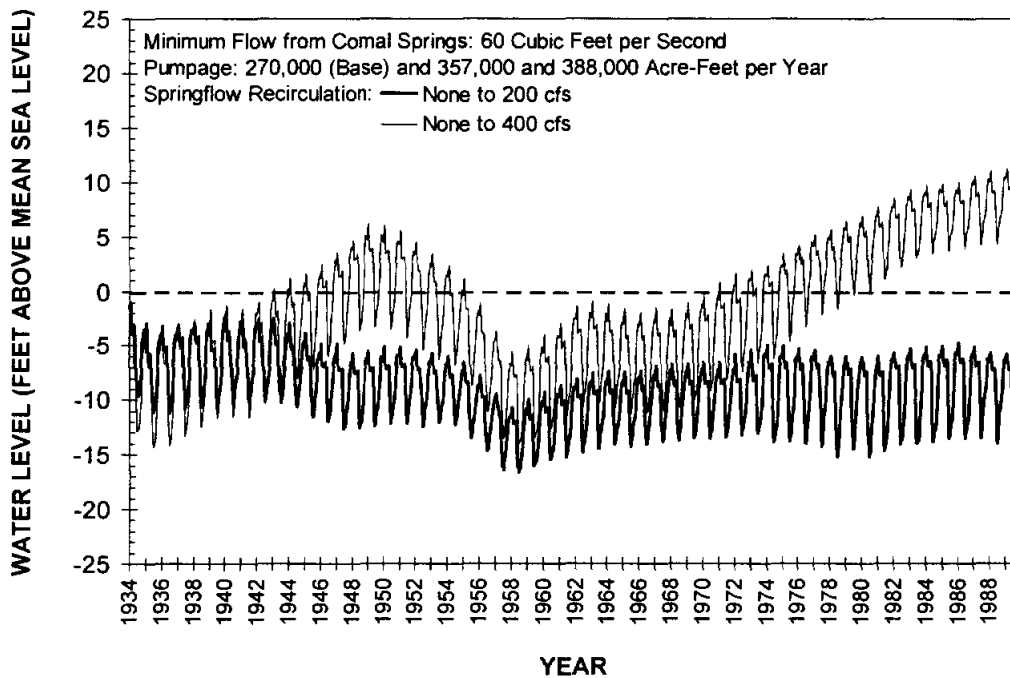

CONCEPTUAL EVALUATION OF  
 SPRINGFLOW RECIRCULATION

TRANS TEXAS WATER PROGRAM /  
 WEST CENTRAL STUDY AREA



HDR Engineering, Inc.

COMPUTED WATER LEVELS  
 AT UVALDE INDEX WELL  
 "SUSTAINED YIELD" PUMPAGE

FIGURE 3.2-8

about 10 ft lower than baseline conditions. However, for the 400 cfs recirculation where there was recharge in the western part of the aquifer, the water levels eventually rose to nearly 10 ft above the baseline conditions. If the 200 cfs management plan was implemented along with increased pumpage, the water use restrictions would be longer, more frequent and possibly more severe for this part of the aquifer than with baseline conditions. However, if the 400 cfs management plan was implemented, the percent of time restrictions would occur is reduced because of the generally higher water levels.

### 3.2.2 Surface Water

#### 3.2.2.1 Streamflows and Water Rights Availability

Simulated median monthly streamflows for the 1934-89 period under the “sustained yield” Edwards Aquifer pumpage management plan are shown in (Figure 3.2-9) for several key locations in the Guadalupe and San Antonio River basins. For comparative purposes the results of the two recirculation rates are shown along with the baseline case of no recirculation. The “sustained yield” pumpage with no recirculation was 270,000 ac-ft/yr and is increased to 357,000 ac-ft/yr with 200 cfs recirculation (Section 3.2.1).

At the H-5 Dam near Gonzales, the diversion of up to 200 cfs for recirculation led to decreases in median monthly streamflows which ranged from approximately 9,000 - 12,000 ac-ft/mo. The decreases are greater than those seen under the 400,000 ac-ft/yr management plan where they ranged from 5,000 - 8,000 ac-ft/mo (Section 3.1.2.1 and Figure 3.1-9) because Edwards Aquifer pumpage here is also increasing between the baseline case and the recirculation cases.

For the 400 cfs recirculation, the “sustained yield” pumpage was increased to 388,000 ac-ft/yr (Section 3.2.1). Under this case Comal Springs discharges are influenced by a combination of the increased recharge and greater pumpage from the aquifer. The net result of this is seen on (Figure 3.2-9) for the H-5 location with increases in median streamflows differing from the baseline by only about +1,000 to +3,000 ac-ft/mo.

At Cuero and at the Saltwater Barrier near Tivoli, the median monthly streamflow pattern showed decreases for all months under both recirculation rates because the diversion locations



GUADALUPE RIVER AT H-5 DAM

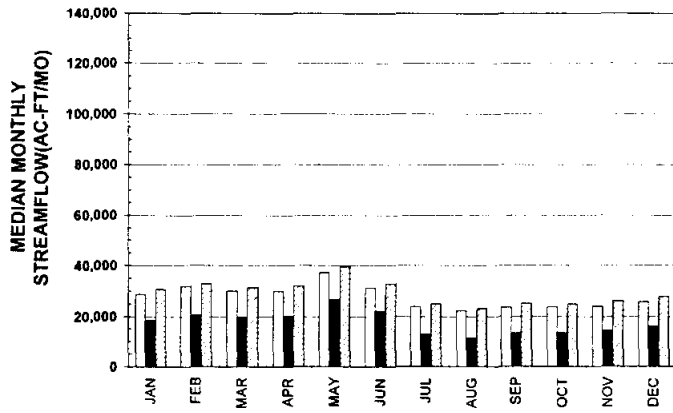

GUADALUPE RIVER AT CUERO

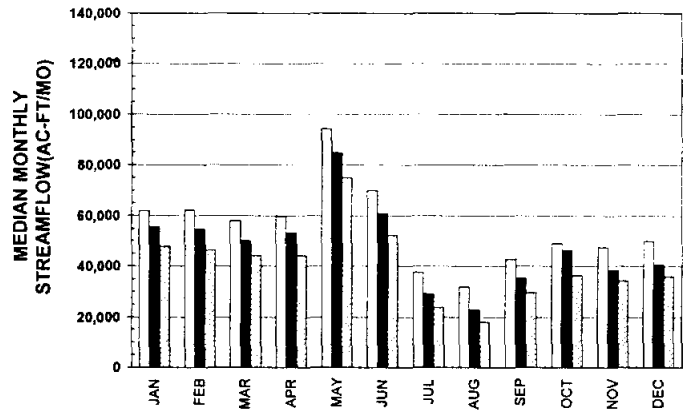

GUADALUPE RIVER AT SALT WATER BARRIER

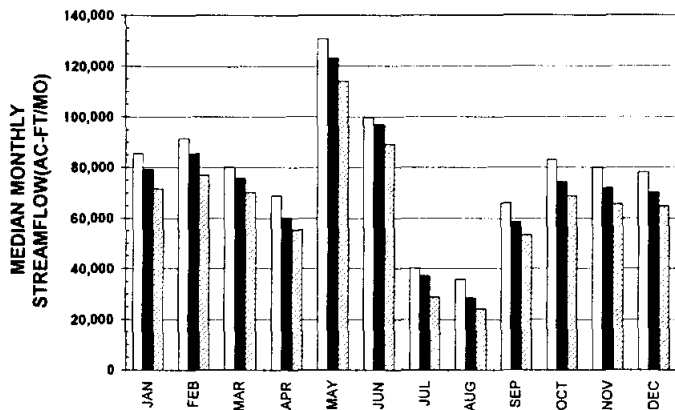

SAN ANTONIO RIVER AT FALLS CITY

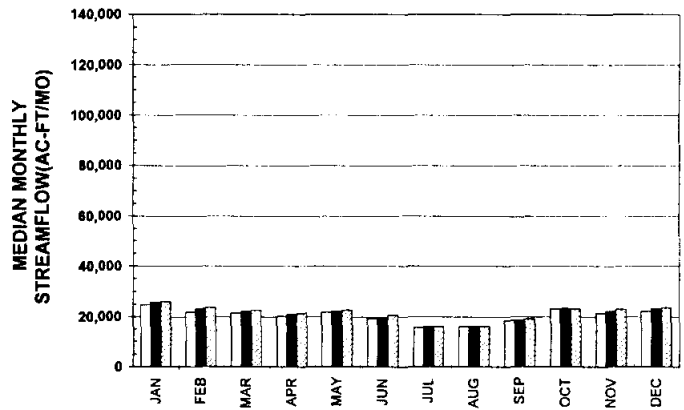

SAN MARCOS RIVER AT LULING

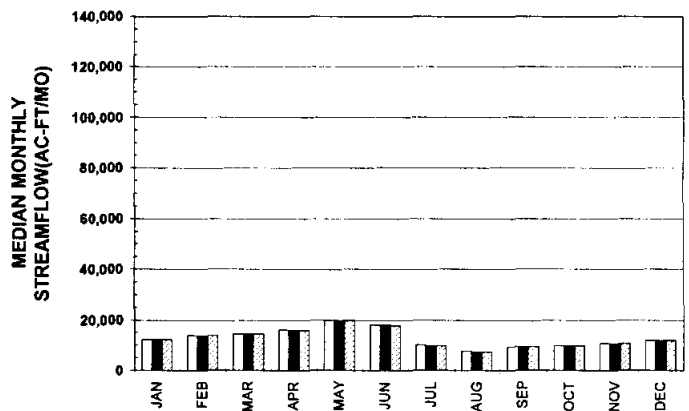

- Baseline: No recirculation  
(Aquifer Pumpage = 270,000 ac-ft/yr)
- Recirculation up to 200 cfs  
(Aquifer Pumpage = 357,000 ac-ft/yr)
- ▨ Recirculation up to 400 cfs  
(Aquifer Pumpage = 388,000 ac-ft/yr)

CONCEPTUAL EVALUATION OF  
SPRINGFLOW RECIRCULATION



HDR Engineering, Inc.

TRANS TEXAS WATER PROGRAM /  
WEST CENTRAL STUDY AREA

MEDIAN MONTHLY STREAMFLOWS  
GUADALUPE - SAN ANTONIO  
RIVER BASIN

"SUSTAINED YIELD" PUMPAGE

FIGURE 3.2-9

were both upstream of these points. For example, at the Saltwater Barrier location, the 200 cfs recirculation led to decreases in median monthly streamflows ranging from about 3,000 to 9,000 ac-ft/mo.

For the two other locations, the San Antonio River near Falls City and the San Marcos River near Luling the monthly median streamflows have a mixed pattern ranging from small increases to very small decreases. This mixed pattern is due to the competing influences of (1) a tendency for springflows to increase as the recirculation of river water for Edwards Aquifer recharge is increased, and (2) the tendency toward reduced springflows as pumpage from the aquifer under the “sustained yield” management plan is increased. Figure 3.2-10 portrays flow frequency plots for these same locations under the three variations of the “sustained yield” management plan.

A summary of the effects of the recirculation of springflows on existing water rights is portrayed in Table 3.2-1. Again, the recirculation generally has very little effect on water rights, except for the very large rights at the extreme lower end of the basin near the Saltwater Barrier. For example, under the baseline case of “sustained yield” pumpage from the Edwards Aquifer and no recirculation, an average shortage of 4,862 ac-ft/yr over the entire 56-year period would occur at the Saltwater Barrier. This would increase to 7,092 ac-ft/yr subject to the recirculation of up to 200 cfs and to 8,054 ac-ft/yr for the 400 cfs recirculation rate.

<b>Table 3.2-1.</b>						
<b>Summary of Water Rights Shortages and Canyon Reservoir Firm Yield for “Sustained Yield” Pumpage</b>						
Location	Total Water Rights (ac-ft)	Shortage or Yield in ac-ft/yr				
		Baseline no Recirculation	Up to 200 cfs Recirculation	Δ	Up to 400 cfs Recirculation	Δ
<b>Long-Term (1934-89) Average</b>						
Guadalupe Riv., Victoria	23,806	0	0	0	0	0
Guadalupe Riv., Saltwater Barrier	220,433	4,862	7,092	2,230	8,054	3,192
San Antonio Riv., Falls City	9,311	0	0	0	0	0
<b>Drought (1947-56) Average</b>						
Guadalupe Riv., Victoria	23,806	0	0	0	0	0
Guadalupe Riv., Saltwater Barrier	220,433	18,887	23,789	4,901	24,112	5,225
San Antonio Riv., Falls City	9,311	0	0	0	0	0
Canyon Lake firm yield		87,124	86,492	-632	86,253	-871

GUADALUPE RIVER AT H-5 DAM

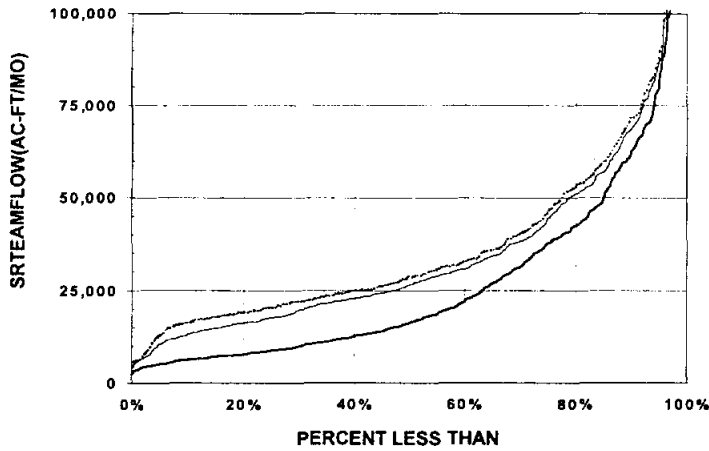

GUADALUPE RIVER AT CUERO

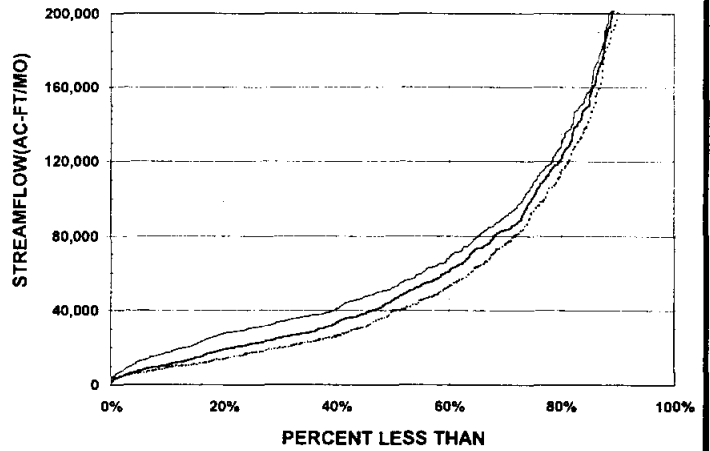

GUADALUPE RIVER AT SALT WATER BARRIER

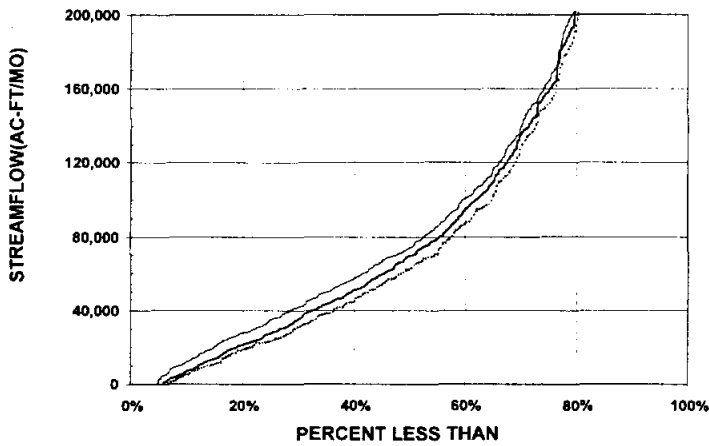

SAN ANTONIO RIVER AT FALLS CITY

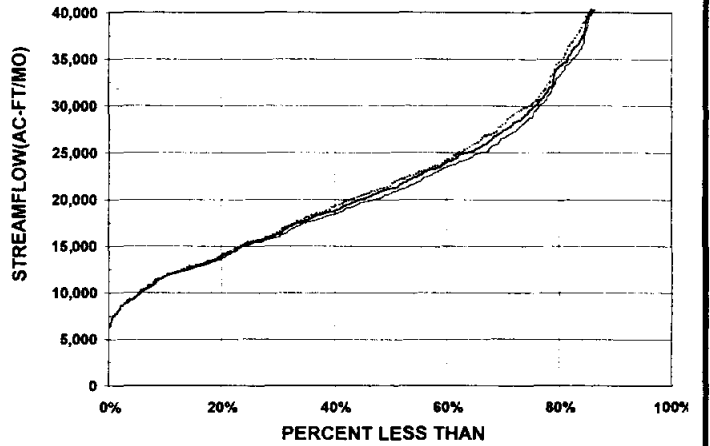

SAN MARCOS RIVER AT LULING

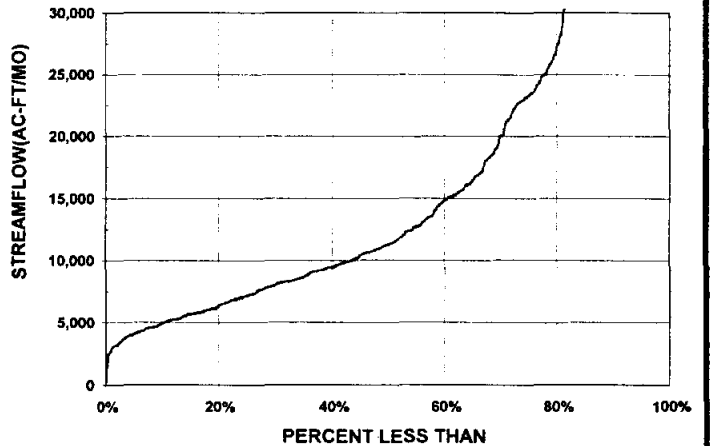

- Baseline: No recirculation  
(Aquifer Pumpage = 270,000 ac-ft/yr)
- Recirculation up to 200 cfs  
(Aquifer Pumpage = 357,000 ac-ft/yr)
- · · Recirculation up to 400 cfs  
(Aquifer Pumpage = 388,000 ac-ft/yr)

CONCEPTUAL EVALUATION OF  
SPRINGFLOW RECIRCULATION



HDR Engineering, Inc.

TRANS TEXAS WATER PROGRAM /  
WEST CENTRAL STUDY AREA

FLOW FREQUENCY CURVES  
GUADALUPE - SAN ANTONIO  
RIVER BASIN

"SUSTAINED YIELD" PUMPAGE

FIGURE 3.2-10

The bottom portion of Table 3.2-1 portrays the simulated impacts on existing water rights during the 1947-56 critical drought period. These shortages are increased by 4,901 and 5,225 ac-ft/yr over the baseline shortages for the 200 cfs and 400 cfs recirculation rates, respectively. The lower portion of Table 3.2-1 also summarizes the small effects of the recirculation on Canyon Lake firm yield. The simulated decreases in Canyon Lake firm yield for the 200 cfs and the 400 cfs recirculation cases represent less than 1 percent of the baseline firm yield.

It is important to note that these increased shortages could be fully mitigated by reducing the recirculation diversion rate at these times when water is needed by these senior water rights. This would decrease the volume of water available for recirculation and reduce the “sustained yield” by an estimated 2,000 to 3,000 ac-ft/yr for either recirculation scenarios.

### 3.2.2.2 Guadalupe Estuary Fisheries Harvest

Table 3.2-2 summarizes the simulated Guadalupe Estuary fisheries harvest for the “sustained yield” management plan under the three variations of recirculation. Again, as under the 400,000 ac-ft/yr management plan, there are a mixture of generally small increases and decreases in predicted harvest depending upon the particular species. More detailed data on Guadalupe Estuary fisheries harvest for the baseline and two recirculation test of this management plan are presented in Appendix A.

<b>Table 3.2-2. Summary of Fisheries Harvest Estimates for the Guadalupe Estuary “Sustained Yield” Pumpage</b>					
Species (klbs)	Baseline no Recirculation	Up to 200 cfs Recirculation	Δ	Up to 400 cfs Recirculation	Δ
White Shrimp	803	818	+15.0	820	+17.0
Brown Shrimp	391	395	+4.0	321	+0.0
Blue Crab	219	210	-9.0	208	-11.0
Eastern Oyster	489	478	-11.0	456	-33.0
Black Drum	27	26	-1.0	25	-2.0
Red Drum	74	73	-1.0	72	-2.0
Seatrout	57	57	+0.0	57	+0.0

(This page intentionally left blank.)

#### 4.0 DISCUSSION OF GROUND WATER MODELING RESULTS

Application of the GWSIM4 Model in the conceptual evaluation of springflow recirculation implies acceptance of at least four major assumptions as valid. These assumptions are: (1) the hydrogeology of the aquifer is reasonably well understood and the many descriptive parameters are mapped across the aquifer correctly, (2) the model is mathematically sound, is properly applied, and sufficiently calibrated, (3) the pumpage estimates are reasonable and accurately distributed in time and space, and (4) the recharge estimates are reasonable and accurately distributed in time and space. Because the conceptual management plans are evaluated primarily by comparison of model runs with a baseline run, errors or model biases are expected to have a similar effect in each test. In other words, calculated water levels, springflow, and leakage from the model may have limited accuracy; but, the calculated differences between tests may be assumed reasonable.

In reviewing the history of the GWSIM4 model, the code was developed in the 1970s for use on mainframe computers (Prickett and Lonquist, 1971).<sup>1</sup> In the mid- to late-1970s, the TWDB applied the model to the Edwards Aquifer in the San Antonio area using best available data and computers (Klemt and others, 1979).<sup>2</sup> Since then, TWDB and others have repeatedly used the original model and a refined version as a management tool and the results have been widely accepted. However, the model is characteristic of its original design and constraints (i.e., the goal of making long term and generalized projections is constrained by a limited understanding of the hydrogeology at the time, limited computer power by current standards, and very laborious data preparation tasks). As a result, the model is dated in several ways. A modern version would be expected to have: (1) a grid that could be regenerated to match details required by the goals of the modeling objective, (2) an hydrogeologic representation that takes into account the hydrogeologic research that has been done in the last 20 years, (3) a means of entering data, especially time dependent data, in a user-friendly manner, (4) a code that can be easily modified for special designs and tests, (5) graphical processors to readily visualize the data

---

<sup>1</sup> Prickett, T.A. and Lonquist, C.G. "Selected digital Computer techniques for ground water resource evaluation" Illinois Water Survey Bulletin 55, 1971.

<sup>2</sup> Klemt, W.B., Knowles, T.R., Elder, G.R., and Sieh, T.W. "Ground-water resources and model applications for the Edwards (Balcones Fault Zone) Aquifer in the San Antonio region, Texas "Texas Water Development Board Rep 239, 1979.

and results, and (6) a design that would facilitate the use as a day-to-day management model that could test the impact of such requests as well permits or recharge/discharge offsets.

Considering the issue of assessing the reliability of the results of the runs made in this report, some potential weaknesses, but no critical shortcomings, are noted. Based on previous studies and professional experience, these weaknesses include:

- The simulated flow from Comal Springs tends to be much too low when actual flow is between 100 and 300 cfs and too high when actual flow was below 50 cfs during the drought of the 1950s. This could be caused by a combination of model calibration and accuracy of the natural recharge, measured springflow discharges, and estimated pumpage. This discrepancy would make the calculations by the model during the critical low flow period of this report appear more favorable than they really are. For example, the "sustained yields" could be less than reported by this study and the duration of the hypothetical drought could be longer than estimated.
- The simulated flow from San Marcos Springs tends to be too low except for drought conditions.
- The simulated flows from San Antonio and San Pedro Springs appear to be about two times more than they should be. Based on correlations with the J-17 index well, this would explain at least part of the erratic springflow patterns noted in this report.
- The simulated water levels in J-17 tend to be too low during normal and above normal water level conditions in the aquifer. The difference is most pronounced after 1977.
- The simulated water levels in the Hill Country Well appear to be about 10 ft too low until the mid-1980s. Then, the match between simulated and measured water levels is generally within a few feet.
- The simulated water levels in the Seco Creek Well show that the water levels in this part of the aquifer are less responsive to major recharge events than the measured water levels indicate.
- The simulated water levels in the Uvalde Well show a reasonable fit during the 1950s drought; but they are much too low after 1977 and show too great a response to seasonal pumping.
- The aquifer permeabilities in the model for the targeted recharge area in Bexar County varied largely without an organized pattern and only partly account for faults in the area. This would show recharge water to migrate more easily to wells in the San Antonio area instead of Comal Springs than may be actually possible. The result would be higher water levels in the San Antonio area and delayed increase in flows at Comal Springs.
- The aquifer permeabilities in the model for northern Medina County tend to be isotropic and follow a regional pattern. The exception is a major fault that acts as a barrier to flow directly from the recharge area in Medina County to the central part of the confined zone.

## 5.0 PROJECT ENGINEERING AND COST ESTIMATES

Two diversion and recharge options were evaluated with respect to sizing of facilities and costs for the recirculation of flow from Comal and San Marcos Springs. One of the options has a capacity of 200 cfs, withdraws water from Lake Dunlap near New Braunfels, and recharges the Edwards Aquifer in northwestern Bexar County (Figure 5.0-1). The other option has a recirculation capacity of up to 400 cfs, and recharges up to 200 cfs of this in northwestern Bexar County and up to 200 cfs in northern Medina County (Figure 5.0-2). In Sections 2 and 3 of this report, all of the water in the 400 cfs recirculation tests was assumed to be diverted below the influence of the Guadalupe and San Marcos Rivers. However, for cost estimation purposes of this section, it was assumed that up to 200 cfs would be withdrawn from Lake Dunlap and up to 200 cfs withdrawn from near Gonzales.

Major facilities to transport the water from the Guadalupe River to the recharge sites include:

- Intake and pump stations
- Raw water pipelines and laterals and booster stations
- Water treatment plant (direct filtration for water diverted from near Gonzales only)
- Recharge structures.

Depending on the option, the intake structures and associated pump stations are located on the shores of Lake Dunlap and Guadalupe River at Gonzales. Raw water pipelines are sized to match the design capacities and booster stations are included as necessary to maintain design capacities and pressures. For the higher turbidity water diverted near Gonzales, water may need to be treated. Therefore, costs have been included for treatment of this water through direct filtration treatment which involves: (1) addition of alum and polymer, (2) rapid mixing, (3) flocculation, (4) settling, and (5) gravity filtration. Within the recharge area, pipelines will transport the water to either the upper reaches of target streams which directly recharge the aquifer or directly to small capacity recharge dams. The main pipeline is stepped down in size after each water delivery site.

One means of recharging the Edwards Aquifer with recirculated springflow is to utilize natural channel losses in the recharge zone of the Edwards Aquifer. To take advantage of these “losses”, water is released in the target stream near the upper limit of the recharge zone and



allowed to flow uncontrolled across the recharge zone. Near the end of the stream segment on the recharge zone, a recharge reservoir captures any remaining water that did not percolate through the streambed. Suitable reservoirs or recharge facilities exist on Panther Springs Creek, tributaries to Salado Creek, San Geranimo Creek, Verde Creek, Parkers Creek, and Seco Creek. Ongoing recharge enhancement studies are recommending a new reservoir on Hondo Creek. Thus, the only additional reservoirs associated with this study are on Culebra Creek and Government Canyon Creek. Cost estimates include all reservoirs that do not exist.

For the management plan with aquifer pumpage of 400,000 ac-ft/yr and a simulated recirculation rate of 200 cfs, a long-term average of 98,400 ac-ft/yr would be recharged at an annual cost of \$28,649,000 (Table 5.1-1). During drought conditions, equivalent to 1947-56, an average of 60,600 ac-ft/yr would be recharged at an average annual cost of \$24,906,000. The average annual cost of recirculated recharge at the 200 cfs recirculation rate would range from \$291/ac-ft on the long-term to \$411/ac-ft during drought. For a simulated recirculation rate of up to 400 cfs, an average of 162,800 ac-ft/yr would be recharged at an average annual cost of \$88,876,000 (Table 5.1-2). During drought conditions, an average of 96,300 ac-ft/yr would be recharged at an average annual cost of \$82,552,000. The average annual cost of recirculated recharge at the 400 cfs recirculation rate would range from \$546/ac-ft on the long-term to \$857/ac-ft during drought. The incremental unit costs for the increased recirculated recharge provided by the 400 cfs option indicate that it may not prove economical as these costs range from \$935 to \$1,615 per ac-ft as shown in Table 5.1-2. Since the measure of improvement due to recirculation for the 400,000 ac-ft/yr pumpage options is in terms of reduced periods of time of mandatory water use restrictions rather than increases in pumpage, annual costs for recirculated recharge should be compared to those for other natural recharge alternatives.

For the management plan with a "sustained yield" pumpage and a simulated recirculation rate of 200 cfs, Edwards Aquifer pumpage is increased by about 87,000 ac-ft/yr. This increased pumpage would be at a unit cost of \$350 per ac-ft under long-term average conditions (Table 5.1-3). During drought conditions when less water is recharged and power costs are reduced, the unit cost decreases to \$326 per ac-ft. These unit costs for increased "sustained yield" are comparable to unit costs for surface water reservoirs and other firm water supply alternatives. For comparison with natural recharge alternatives, annual costs of recirculated

recharge at the 200 cfs recirculation rate would range from \$261/ac-ft on the long-term to \$296/ac-ft during drought.

For the option with a recirculation rate of up to 400 cfs, the “sustained yield” pumpage is increased by 118,000 ac-ft/yr. For this option, the long-term average unit cost is \$774 per ac-ft (Table 5.1-4). During drought conditions, unit cost is reduced to \$717 per ac-ft as pumping costs are reduced. For comparison with natural recharge alternatives, annual costs of recirculated recharge at the 400 cfs recirculation rate would range from \$490/ac-ft on the long-term to \$720/ac-ft during drought. The incremental unit costs for the increased “sustained yield” pumpage or recirculated recharge provided by the 400 cfs option indicate that it may not prove economical as these costs range from \$875 to \$2,605 per ac-ft as shown in Table 5.1-4.

**Table 5.1-1**  
**Cost Estimate Summaries for 400,000 ac-ft/yr Aquifer Pumpage**  
**with up to 200 cfs Diversions from Lake Dunlap to Northwestern Bexar County**  
**(L-22A)**  
**(First Quarter 1996 Prices)**

Item	Average Annual Diversion to Recharge Zone	Drought (1) Annual Diversion to Recharge Zone
<b>Capital Costs</b>		
Transmission and Pumping	\$123,936,000	
Treatment Plant	0	
New Reservoirs	<u>4,020,000</u>	
<b>Total Capital Costs</b>	<b>\$127,956,000</b>	
Engineering, Contingencies, and Legal Costs	\$38,810,000	
Land Acquisition	1,630,000	
Environmental Studies and Mitigation	1,678,000	
Interest During Construction	<u>8,164,000</u>	
<b>Total Project Costs</b>	<b>\$178,238,000</b>	
<b>Annual Costs</b>		
Annual Debt Service	\$16,754,000	\$16,754,000
Annual Operation and Maintenance	2,243,000	2,243,000
Annual Power Costs	<u>9,652,000</u>	<u>5,909,000</u>
<b>Total Annual Costs</b>	<b>\$28,649,000</b>	<b>\$24,906,000</b>
Average Annual Recirculated Recharge <sup>(2)</sup> (acft/yr)	98,400	60,600
Annual Cost of Recirculated Recharge	\$291/acft	\$411/acft
Notes:		
(1) Drought annual averages for 1947-56 historical period		
(2) Recirculated recharge is springflow diverted below Comal Springs, delivered via transmission pipeline to Northwestern Bexar County, and allowed to recharge the Edwards Aquifer		

**Table 5.1-2**  
**Cost Estimate Summaries for 400,000 ac-ft/yr Aquifer Pumpage**  
**with up to 400 cfs Diversions from Lake Dunlap and Gonzales and**  
**Recharge to Northwestern Bexar County and Northern Medina County**  
**(L-22B)**  
**(First Quarter 1996 Prices)**

Item	Average Annual Diversion to Recharge Zone	Drought (1) Annual Diversion to Recharge Zone
<b>Capital Costs</b>		
Transmission and Pumping	\$425,010,000	
Treatment Plant	30,121,000	
New Reservoirs	<u>5,360,000</u>	
<b>Total Capital Costs</b>	<b>\$460,491,000</b>	
Engineering, Contingencies, and Legal Costs	\$141,252,000	
Land Acquisition	3,558,000	
Environmental Studies and Mitigation	3,542,000	
Interest During Construction	<u>29,224,000</u>	
<b>Total Project Costs</b>	<b>\$638,067,000</b>	
<b>Annual Costs</b>		
Annual Debt Service	\$59,978,000	\$59,978,000
Annual Operation and Maintenance	13,434,000	13,434,000
Annual Power Costs	<u>15,464,000</u>	<u>9,140,000</u>
<b>Total Annual Costs</b>	<b>\$88,876,000</b>	<b>\$82,552,000</b>
Average Annual Recirculated Recharge <sup>(2)</sup> (acft/yr)	162,800	96,300
Annual Cost of Recirculated Recharge	\$546/acft	\$857/acft
Incremental Total Annual Cost Increase Above 200 cfs	\$60,227,000	\$57,646,000
Incremental Increase in Average Annual Recirculated Recharge Above 200 cfs (acft/yr)	64,400	35,700
Incremental Annual Cost of Recirculated Recharge Above 200 cfs	\$935/acft	\$1,615/acft
Notes:		
(1) Drought annual averages for 1947-56 historical period.		
(2) Recirculated recharge is springflow diverted from the Guadalupe River at Lake Dunlap and near Gonzales, delivered via transmission pipelines to northwestern Bexar County and northern Medina County, and allowed to recharge the Edwards Aquifer.		

**Table 5.1-3**  
**Cost Estimate Summaries for "Sustained Yield"<sup>(1)</sup> Aquifer Pumpage**  
**with up to 200 cfs Diversions from Lake Dunlap to Northwestern Bexar County**  
**(L-23A)**  
**(First Quarter 1996 Prices)**

Item	Average Annual Diversion to Recharge Zone	Drought <sup>(2)</sup> Annual Diversion to Recharge Zone
<b>Capital Costs</b>		
Transmission and Pumping	\$123,936,000	
Treatment Plant	0	
New Reservoirs	<u>4,020,000</u>	
<b>Total Capital Costs</b>	<b>\$127,956,000</b>	
Engineering, Contingencies, and Legal Costs	\$38,810,000	
Land Acquisition	1,630,000	
Environmental Studies and Mitigation	1,678,000	
Interest During Construction	<u>8,164,000</u>	
<b>Total Project Costs</b>	<b>\$178,238,000</b>	
<b>Annual Costs</b>		
Annual Debt Service	\$16,754,000	\$16,754,000
Annual Operation and Maintenance	2,243,000	2,243,000
Annual Power Costs	<u>11,438,000</u>	<u>9,357,000</u>
<b>Total Annual Costs</b>	<b>\$30,435,000</b>	<b>\$28,354,000</b>
Increase in "Sustained Yield" (acft/yr)	87,000	87,000
Annual Cost of Increase in "Sustained Yield"	\$350/acft	\$326/acft
Average Annual Recirculated Recharge <sup>(3)</sup> (acft/yr)	116,600	95,900
Annual Cost of Recirculated Recharge	\$261/acft	\$296/acft
Notes:		
(1) "Sustained Yield" is the maximum fixed annual pumpage from the Edwards Aquifer subject to which discharge at Comal springs remains above 60 cfs during the most severe drought on record.		
(2) Drought annual averages for 1947-56 historical period.		
(3) Recirculated recharge is springflow diverted below Comal Springs, delivered via transmission pipeline to northwestern Bexar County, and allowed to recharge the Edwards Aquifer.		

**Table 5.1-4**  
**Cost Estimate Summaries for "Sustained Yield"<sup>(1)</sup> Aquifer Pumpage**  
**with up to 400 cfs Diversions from Lake Dunlap and Gonzales and**  
**Recharge to Northwestern Bexar County and Northern Medina County**  
**(L-23B)**  
**(First Quarter 1996 Prices)**

Item	Average Annual Diversion to Recharge Zone	Drought <sup>(2)</sup> Annual Diversion to Recharge Zone
<b>Capital Costs</b>		
Transmission and Pumping	\$425,010,000	
Treatment Plant (for Gonzales water only)	30,121,000	
New Reservoirs	5,360,000	
<b>Total Capital Costs</b>	<b>\$460,491,000</b>	
Engineering, Contingencies, and Legal Costs	\$141,252,000	
Land Acquisition	3,558,000	
Environmental Studies and Mitigation	3,542,000	
Interest During Construction	29,224,000	
<b>Total Project Costs</b>	<b>\$638,067,000</b>	
<b>Annual Costs</b>		
Annual Debt Service	\$59,978,000	\$59,978,000
Annual Operation and Maintenance	13,434,000	13,434,000
Annual Power Costs	17,869,000	11,202,000
<b>Total Annual Costs</b>	<b>\$91,281,000</b>	<b>\$84,614,000</b>
Incremental Total Annual Cost Increase Above 200 cfs	\$60,846,000	\$56,260,000
Increase in "Sustained Yield" (acft/yr)	118,000	118,000
Annual Cost of Increase in "Sustained Yield"	\$774/acft	\$717/acft
Incremental Increase in "Sustained Yield" Above 200 cfs (acft/yr)	31,000	31,000
Incremental Annual Cost of Increase in "Sustained Yield" Above 200 cfs	\$1,963/acft	\$1,815/acft
Average Annual Recirculated Recharge <sup>(3)</sup> (acft/yr)	186,100	117,500
Annual Cost of Recirculated Recharge	\$490/acft	\$720/acft
Incremental Increase in Average Annual Recirculated Recharge Above 200 cfs (acft/yr)	69,500	21,600
Incremental Annual Cost of Recirculated Recharge Above 200 cfs	\$875/acft	\$2,605/acft
Notes:		
(1) "Sustained Yield" is the maximum fixed annual pumpage from the Edwards Aquifer subject to which discharge at Comal springs remains above 60 cfs during the most severe drought on record.		
(2) Drought annual averages for 1947-56 historical period.		
(3) Recirculated recharge is springflow diverted from the Guadalupe River at Lake Dunlap and near Gonzales, delivered via transmission pipelines to northwestern Bexar County and northern Medina County, and allowed to recharge the Edwards Aquifer.		

(This page intentionally left blank.)

## 6.0 SUMMARY

A conceptual evaluation of springflow recirculation was performed for two management plans. These plans were evaluated with the GWSIM4 computer model of the Edwards Aquifer developed by the Texas Water Development Board. One of the plans established a fixed aquifer pumpage of 400,000 ac-ft/yr and the other established pumpage at "sustained yield" rates. For each plan, baseline model simulations were made with no springflow recirculation to determine how each plan affects springflows and water levels. Recirculation evaluations were made with up to 200 cfs diverted downstream of Comal Springs and recharged in northwestern Bexar County, and another test with up to 400 cfs diverted downstream of Comal Springs and San Marcos Springs and recharged to northwestern Bexar County and northern Medina County. Each model simulation used the 1934-89 historical pattern of recharge, including the critical drought of 1947-56 to evaluate aquifer water levels and springflows. For the diversion of up to 200 cfs, only Comal Spring flow in excess of 60 cfs was considered to be available for diversion. For the maximum 400 cfs diversion, the combined springflow from Comal Springs and San Marcos Springs in excess of 160 cfs was considered to be available. In addition to the occasional lack of available springflow in the Guadalupe River, a lack of additional aquifer storage in the target recharge areas occasionally limited the amount of recirculated water.

For the 400,000 ac-ft/yr management plan, averages of 98,400 and 162,800 ac-ft/yr was recirculated back to the aquifer for the 200 cfs and 400 cfs tests, respectively. This increases the recharge by 15 and 25 percent, respectively. Because pumpage was fixed, most of the recirculated water became enhanced springflow at Comal Springs. Model results showed that, during the critical drought, the duration of the flow below the 60 cfs level was 9.25 years for the baseline conditions with no recirculation. This declined to 2.75 years with up to 200 cfs recirculation, and to only one year with 400 cfs recirculation. For the three simulations, Comal Springs had 'no flow' conditions, with durations of 2.75, 0.50, and zero years, respectively. The average flow for the Guadalupe River in the immediate vicinity of Comal Springs and downstream of the diversion for the 1934-89 test period decreased by an average of 35 cfs for the 200 cfs recirculation rate and by 86 cfs for the 400 cfs recirculation rate. However, during the drought period of 1947-56, the flows increased an average of 9 cfs for each of the two tests. Considering the water levels in the J-17 index well in San Antonio, the minimum water levels



were 8.8 ft higher with the 200 cfs recirculation rate and 10.0 ft higher with the 400 cfs recirculation rate. This general rise in water levels decreased the amount of time that the San Antonio area was in the most severe stage of the drought management plan from 13.4 years with no recirculation to 3.2 years for 200 cfs recirculation and to 1.2 years with 400 cfs recirculation.

The springflow recirculation diversions were also evaluated with respect to their effects on the availability of water to satisfy surface water rights and Guadalupe Estuary fisheries harvests. Under the 400,000 ac-ft/yr management plan, the principal impacts are reductions in streamflow below the recirculation diversion sites. For example, for the Guadalupe River at Cuero and for the Saltwater Barrier there were decreases in median monthly streamflows for nearly all months under both recirculation rates. Compared to the baseline case of no recirculation, the decreases were generally on the order of 4,000 ac-ft/mo for the 200 cfs recirculation and about 8,000 ac-ft/mo for the 400 cfs recirculation.

For locations on the San Antonio River near Falls City and the San Marcos River near Luling the median monthly streamflows predominantly showed small increases as the recirculation rate was increased. These locations benefit from the increased springflows of San Antonio, San Pedro, and San Marcos Springs which result from increased Edwards Aquifer recharge and storage.

Generally, recirculation of Guadalupe River water under 400,000 ac-ft/yr management plan would have little effect on water rights. For example, the average simulated shortage for large water rights at the Saltwater Barrier would increase from 7,326 ac-ft/yr to only 7,345 ac-ft/yr and to only 8,081 ac-ft/yr for the 200 cfs and the 400 cfs recirculation tests, respectively. For the 1947-56 critical drought period springflow recirculation would actually improve the availability of water to satisfy downstream rights. Compared to the baseline, a recirculation rate of 200 cfs or 400 cfs would decrease the average water rights shortage by 1,019 ac-ft/yr or 1,422, respectively during the critical drought. The estimated firm yield of Canyon Lake would be essentially unaffected by either to 200 cfs or 400 cfs recirculation rates under the 400,000 ac-ft/yr management plan. The effects of recirculation on Guadalupe Estuary fisheries harvest are also quite small based on the seven commercial species considered.

For the "sustained yield" management plan, Edwards Aquifer pumpage was allowed at a rate that would not cause the monthly flow from Comal Springs to fall below the critical level of 60 cfs during the drought of record. Based on model simulations, pumpage would be 270,000 ac-ft/yr under baseline conditions with no recirculation, 357,000 ac-ft/yr for a recirculation rate of up to 200 cfs and 388,000 ac-ft/yr for a recirculation rate of up to 400 cfs. Averages of 116,600 ac-ft/yr and 186,100 ac-ft/yr were recirculated back to the aquifer for the 200 cfs and 400 cfs tests, respectively. This increased the total recharge by 18 and 29 percent, respectively. About 75 percent of the recirculated water for the 200 cfs recirculation and about 64 percent of the water recirculated for the 400 cfs recirculation was later pumped from the aquifer. Even with the increase in aquifer pumpage, the long-term average flow from Comal Springs increased by 33 cfs for the 200 cfs recirculation rate and by 38 cfs for the 400 cfs recirculation rate. In the immediate vicinity of the diversion sites on the Guadalupe River, the average flow for the 1934-89 test period decreased by 97 cfs for the 200 cfs recirculation rate and 220 cfs for the 400 cfs recirculation rate. However, during the drought period of 1947-56, the flow decrease was considerably less than the 56-year average. Considering the water levels in the J-17 index well in San Antonio, the minimum water levels were 4.5 ft lower with the 200 cfs recirculation rate and 5.2 ft lower with the 400 cfs recirculation rate due to the increased pumpage. This general lowering of water levels would slightly increase the amount of time that the San Antonio area was in the most severe stage of the drought management plan from one or two months with no recirculation to six months for 200 cfs and 400 cfs recirculation rates.

The principal impacts of the "sustained yield" management plan include reductions in streamflow below the diversion sites. At the Saltwater Barrier, there were decreases in monthly median streamflows for nearly all months under both recirculation rates. The decreases were generally on the order of 6,000 ac-ft/mo for the 200 cfs recirculation and about 14,000 ac-ft/mo for the 400 cfs recirculation when compared to the baseline case of no recirculation. For locations on the San Antonio River near Falls City and the San Marcos River near Luling there were essentially no effects on median monthly streamflows as the recirculation rate was increased.

The recirculation of springflows under the "sustained yield" pumpage management plan has some effects on the large water rights near the Saltwater Barrier. The simulated average

shortage at the Saltwater Barrier would increase from 4,862 ac-ft/yr to 7,092 ac-ft/yr and to 8,054 ac-ft/yr for the 200 cfs and 400 cfs recirculation tests, respectively. For the 1947-56 critical drought period springflow recirculation would increase the average water rights shortage by 4,901 ac-ft/yr during the critical drought and by 5,225 ac-ft/yr with 400 cfs recirculation if not mitigated. These additional shortages can, in part, be eliminated by reducing the diversion rate of the pumping stations when downstream water rights shortages are imminent. The firm yield of Canyon Lake could decrease by 632 ac-ft/yr under the 200 cfs recirculation test and decrease by 871 ac-ft/yr with the 400 cfs recirculation. The simulated effects of the recirculation under the "sustained yield" pumpage management plan on the fisheries harvest of the Guadalupe Estuary are quite small with variable effects on seven commercial species.

For the management plan with a "sustained yield" pumpage and a simulated recirculation rate of 200 cfs, Edwards Aquifer pumpage is increased by about 87,000 ac-ft/yr. This increased pumpage would be at a unit cost of \$350 per ac-ft under long-term average conditions. During drought conditions when less water is recharged and power costs are reduced, the unit cost decreases to \$326 per ac-ft. For the option with a recirculative rate of up to 400 cfs, the "sustained yield" pumpage is increased by 118,000 ac-ft/yr. For this option, the long-term average unit cost is \$774 per ac-ft. During drought conditions, unit cost is reduced to \$717 per ac-ft as pumping costs are reduced. The incremental unit cost for the extra 31,000 ac-ft/yr of pumpage provided by the 400 cfs option is not economical as it ranges between \$1,963 and \$1,815 per ac-ft.

## 7.0 CONCLUSIONS AND RECOMMENDATIONS

The conceptual evaluation of Edwards Aquifer springflow recirculation indicates that implementation of this concept may offer a substantial opportunity for ensuring maintenance of springflows and for increasing the availability of ground water for water supply purposes during sustained droughts. Under the “sustained yield” scenario, springflow recirculation has been examined in a manner analogous to conventional surface water projects in that a firm, dependable increase in aquifer pumpage has been estimated which is subject to maintenance of a specified minimum component of Comal springflow (60 cfs) remaining in the river downstream of the diversion. Maintenance of springflows during drought conditions is a requirement by year 2012 under Senate Bill 1477, 1993 Texas Legislature.

Results of the “sustained yield” evaluation indicate that fixed annual pumpage could be increased by 87,000 ac-ft/yr based on facilities capable of diversion and transmission of up to 200 cfs of springflow from Dunlap Lake to the Edwards Aquifer recharge zone in northwestern Bexar County. The long-term average unit cost for this plan is \$350/ac-ft/yr. Simulated impacts of springflow recirculation on downstream water rights are relatively small and potentially avoidable on a real-time basis by temporarily halting recirculation diversions during critical shortages. Results of a second “substantial yield” evaluation in which up to an additional 200 cfs was recirculated from facilities located near Gonzales and recharged in Medina County, indicate that an additional 31,000 ac-ft/yr of aquifer pumpage could be sustained. However, the additional facilities needed to transport the water the extra distance results in unit cost of about \$2,000 per ac-ft/yr for this additional water.

It is important to note that the “sustained yield” Edwards Aquifer pumpage under either recirculation scenario is still less than 400,000 ac-ft/yr. Hence, springflow recirculation will most likely be considered as one component of several water management strategies that are expected to be based on the conjunctive use of surface and ground water supply sources. For example, operation of springflow recirculation diversion and transmission facilities in conjunction with conventional delivery, treatment and distribution of water from the Guadalupe River to Bexar County could provide significant economies of scale. Additionally, springflow recirculation should be further evaluated in conjunction with proposed recharge enhancement dams to determine the combined benefits and unit costs when operated as a system.

To more fully evaluate the potential benefits of springflow recirculation, it is recommended that the current version of GWSIM4 be improved to more accurately evaluate potential and recommended springflow recirculation and recharge enhancement projects. These improvements should include: (1) the ability to easily modify starting head conditions within the model, (2) a reevaluation of the head-discharge relationships at each spring, especially at San Antonio, San Pedro, and Leona Springs, (3) a consideration of discharge from Hueco Springs and any recharge from the Guadalupe River, and (4) a consideration of recharge coming from Onion Creek which may improve simulations at San Marcos Springs. These improvements are not intended to eliminate the need for a new generation ground water model of the aquifer system in the San Antonio area.

After GWSIM4 is improved, it is recommended that the following analysis be performed to fully evaluate the benefits of the recharge enhancement projects on the basis of "sustained yields" and unit cost of increased "sustained yields" both with and without springflow recirculation.

- Use GWSIM4 to determine in a systematic manner "sustained yield" pumpage and associated unit costs for individual or groups of recommended recharge projects. This would be done initially without recirculation;
- Use GWSIM4 to determine optimum recirculation rate from Lake Dunlap with recommended recharge projects in place and determine "sustained yield" and unit costs for a range of recirculation rates. Consider adding other water sources, i.e., unappropriated water, unutilized water rights, or purchased water rights at Lake Dunlap. Also, consider the water supply benefits and costs of extending the recirculation pipeline to Medina Lake on both aquifer yield and reservoir yield. (Note: This analysis is intended to determine the upper limit of aquifer pumpage for the combined effects of multiple recharge projects and water sources.)
- Determine optimum combination of recharge projects and recirculation rate by a systematic elimination of selected recharge projects to determine increased "sustained yield" and unit costs with recirculation in place; and
- Recommend optimum system and consider institutional and permitting issues associated with implementation to allow for pumping and springflow benefits to be fully realized.

**APPENDIX A**  
**GUADALUPE ESTUARY DATA**

TRANS-TEXAS WATER PROGRAM, WEST CENTRAL STUDY AREA, PHASE 2  
 HDR JOB# = 07755-026-036 DATE = 2/19/98  
 SCENARIO: TASK1 EDWARDS PUMPAGE @ 400,000 AC-Ft/YR, NO RECIRCULATION.

FRESHWATER INFLOWS (ACFT) - GUADALUPE ESTUARY  
 \*\*\*\*\*

MONTH	AVERAGE	10%<	25%<	50%<	75%<	90%<
*****	*****	****	****	****	****	****
JAN	122610.	11971.	46832.	78627.	131719.	242787.
FEB	130352.	23421.	47209.	90372.	147640.	265961.
MAR	108462.	16081.	39206.	77093.	164142.	234519.
APR	143625.	12002.	31356.	63311.	157845.	439136.
MAY	231556.	22215.	36978.	123888.	347480.	568113.
JUN	224265.	92.	30326.	93173.	256220.	490598.
JUL	119278.	0.	4286.	36658.	135128.	298219.
AUG	56872.	0.	5620.	33720.	74088.	137147.
SEP	173764.	1857.	20651.	70411.	187287.	411799.
OCT	163974.	9777.	27332.	82673.	146490.	358542.
NOV	129219.	13140.	40008.	74700.	163394.	291026.
DEC	116226.	15149.	41227.	74899.	146180.	246523.

UPPER SAN ANTONIO BAY SALINITY (PPT)  
 \*\*\*\*\*

MONTH	AVERAGE	10%<	25%<	50%<	75%<	90%<	#V SUB	#V SLB
*****	*****	****	****	****	****	****	*****	*****
JAN	13.30	2.43	7.46	12.73	16.80	22.44	11	10
FEB	12.31	1.87	7.89	11.86	16.74	19.20	6	11
MAR	13.70	4.24	6.80	12.82	17.53	23.03	12	8
APR	14.42	.00	7.48	14.59	20.04	26.73	15	11
MAY	10.75	.00	.70	9.24	18.74	22.78	17	14
JUN	14.17	.00	2.68	11.00	19.47	36.22	20	9
JUL	21.85	.90	8.18	18.42	32.76	45.00	36	5
AUG	22.59	6.45	12.69	19.37	30.42	45.00	37	0
SEP	16.05	.00	4.61	13.21	22.12	34.08	15	14
OCT	13.77	.18	4.15	12.55	20.70	23.78	16	14
NOV	13.63	1.22	7.14	13.30	17.32	26.68	10	9
DEC	13.82	2.81	8.10	12.97	17.97	21.81	12	7

LOWER SAN ANTONIO BAY SALINITY (PPT)  
 \*\*\*\*\*

MONTH	AVERAGE	10%<	25%<	50%<	75%<	90%<	#V SUB	#V SLB
*****	*****	****	****	****	****	****	*****	*****
JAN	22.24	12.22	16.90	21.80	25.59	30.84	16	0
FEB	21.32	11.70	17.30	20.99	25.53	27.82	17	0
MAR	22.60	13.90	16.28	21.88	26.27	31.38	16	0
APR	23.06	9.38	16.92	23.53	28.60	34.83	23	1
MAY	19.23	7.05	10.60	18.55	27.39	31.16	17	2
JUN	21.86	8.33	12.45	20.19	28.07	43.66	17	2
JUL	28.44	10.79	17.56	27.09	40.44	45.00	35	2
AUG	29.99	15.95	21.76	27.98	38.27	45.00	35	0
SEP	23.94	9.20	14.24	22.25	30.54	41.67	25	1
OCT	22.35	10.12	13.81	21.64	29.22	32.09	19	2
NOV	22.40	11.09	16.60	22.34	26.07	34.78	19	0
DEC	22.73	12.57	17.49	22.02	26.68	30.25	21	0

TRANS-TEXAS WATER PROGRAM, WEST CENTRAL STUDY AREA, PHASE 2  
 HDR JOB# = 07755-026-036 DATE = 2/19/98  
 SCENARIO: TASK1 EDWARDS PUMPAGE @ 400,000 AC-FT/YR, NO RECIRCULATION.

ESPIRITU SANTO BAY SALINITY (PPT)  
 \*\*\*\*\*

MONTH	AVERAGE	10%<	25%<	50%<	75%<	90%<	#V SUB	#V SLB
*****	*****	****	****	****	****	****	*****	*****
JAN	27.32	22.56	24.78	27.10	28.90	31.38	0	0
FEB	26.87	22.31	24.96	26.72	28.87	29.95	0	0
MAR	27.53	23.35	24.48	27.14	29.22	31.64	1	0
APR	27.82	21.21	24.78	27.92	30.32	33.28	1	0
MAY	26.02	20.11	21.79	25.56	29.75	31.54	1	0
JUN	27.84	20.71	22.67	26.33	30.07	37.46	6	0
JUL	31.83	21.88	25.09	29.61	35.94	45.00	13	0
AUG	31.97	24.33	27.08	30.03	34.91	45.00	8	0
SEP	28.64	21.13	23.52	27.31	31.24	36.52	5	0
OCT	27.39	21.56	23.31	27.02	30.61	31.98	0	0
NOV	27.51	22.02	24.63	27.35	29.12	33.26	1	0
DEC	27.54	22.72	25.06	27.21	29.41	31.10	0	0

ANNUAL NUTRIENT AND SEDIMENT CONSTRAINTS  
 \*\*\*\*\*

SIMULATED FRESHWATER INFLOWS LESS THAN NUTRIENT CONSTRAINT ( 860000. ACFT/YR) IN 14 YEARS  
 SIMULATED FRESHWATER INFLOWS LESS THAN SEDIMENT CONSTRAINT ( 355235. ACFT/YR) IN 5 YEARS

ANNUAL FISHERIES HARVEST (KLBS) - GUADALUPE ESTUARY  
 \*\*\*\*\*

SPECIES	AVERAGE	10%<	25%<	50%<	75%<	90%<	# YRS
*****	*****	****	****	****	****	****	*****
WHITE SHRIMP	819.	369.	612.	802.	1003.	1111.	38
BROWN SHRIMP	396.	73.	142.	307.	583.	700.	46
BLUE CRAB	211.	41.	44.	149.	255.	499.	46
OYSTER	478.	54.	54.	396.	619.	1039.	42
BLACK DRUM	26.	0.	5.	16.	40.	57.	45
RED DRUM	73.	31.	42.	56.	89.	123.	42
SEATROUT	57.	19.	27.	42.	77.	115.	49
TOTAL	2013.	1386.	1511.	1732.	2343.	3022.	30



TRANS-TEXAS WATER PROGRAM, WEST CENTRAL STUDY AREA, PHASE 2  
 HDR JOB# = 07755-026-036 DATE = 2/19/98  
 SCENARIO: TASK2A EDWARDS PUMPAGE @ 400,000 AC-FT/YR, RECIR. <= 200 CFS

FRESHWATER INFLOWS (ACFT) - GUADALUPE ESTUARY  
 \*\*\*\*\*

MONTH	AVERAGE	10%<	25%<	50%<	75%<	90%<
*****	*****	****	****	****	****	****
JAN	120300.	12438.	43218.	77159.	126952.	249632.
FEB	127786.	21131.	44285.	85677.	143280.	269916.
MAR	105990.	16614.	34334.	75868.	160482.	229612.
APR	141335.	9559.	28052.	59190.	153646.	433724.
MAY	229249.	20069.	32730.	118020.	342265.	560791.
JUN	222195.	92.	24668.	97038.	250134.	485179.
JUL	117662.	0.	1335.	34700.	131136.	293799.
AUG	55502.	0.	5217.	31798.	70870.	132883.
SEP	172440.	1132.	18921.	66805.	189175.	410623.
OCT	162473.	11432.	23657.	77579.	152752.	364211.
NOV	127414.	11054.	38752.	70645.	155708.	298320.
DEC	114320.	12896.	40628.	69599.	141746.	242419.

UPPER SAN ANTONIO BAY SALINITY (PPT)  
 \*\*\*\*\*

MONTH	AVERAGE	10%<	25%<	50%<	75%<	90%<	#V SUB	#V SLB
*****	*****	****	****	****	****	****	*****	*****
JAN	13.49	2.47	7.64	13.05	17.15	22.72	11	10
FEB	12.54	1.95	7.54	12.30	17.44	19.75	6	11
MAR	13.91	4.43	7.24	13.18	18.50	23.72	13	7
APR	14.80	.00	7.69	15.20	20.83	27.16	16	11
MAY	10.94	.00	.81	9.45	18.57	23.29	17	14
JUN	14.57	.00	2.81	11.22	18.66	40.57	20	9
JUL	22.58	.76	8.38	19.00	41.06	45.00	36	5
AUG	23.33	6.21	12.81	19.54	33.42	45.00	37	0
SEP	16.51	.00	4.75	13.38	22.79	37.54	17	14
OCT	13.96	.19	4.27	12.95	21.69	25.44	16	14
NOV	13.86	1.24	7.35	13.72	18.05	26.35	10	9
DEC	14.01	2.92	8.38	13.19	18.13	22.47	12	7

LOWER SAN ANTONIO BAY SALINITY (PPT)  
 \*\*\*\*\*

MONTH	AVERAGE	10%<	25%<	50%<	75%<	90%<	#V SUB	#V SLB
*****	*****	****	****	****	****	****	*****	*****
JAN	22.43	12.26	17.06	22.10	25.91	31.09	16	0
FEB	21.54	11.76	16.97	21.40	26.19	28.33	17	0
MAR	22.86	14.07	16.69	22.22	27.17	32.03	17	0
APR	23.41	9.30	17.11	24.10	29.34	35.23	25	1
MAY	19.46	7.02	10.70	18.75	27.24	31.63	17	2
JUN	22.19	8.39	12.57	20.40	27.32	45.00	18	2
JUL	28.94	10.67	17.75	27.64	45.00	45.00	35	2
AUG	30.54	15.74	21.88	28.14	41.06	45.00	34	0
SEP	24.29	9.33	14.37	22.41	31.16	44.89	25	1
OCT	22.58	10.13	13.92	22.01	30.14	33.63	20	2
NOV	22.62	11.11	16.79	22.73	26.75	34.48	18	0
DEC	22.89	12.67	17.75	22.23	26.83	30.86	22	0

TRANS-TEXAS WATER PROGRAM, WEST CENTRAL STUDY AREA, PHASE 2  
 HDR JOB# = 07755-026-036 DATE = 2/19/98  
 SCENARIO: TASK2A EDWARDS PUMPAGE @ 400,000 AC-FT/YR,RECIR. <= 200 CFS

ESPIRITU SANTO BAY SALINITY (PPT)  
 \*\*\*\*\*

MONTH	AVERAGE	10%<	25%<	50%<	75%<	90%<	#V SUB	#V SLB
*****	*****	****	****	****	****	****	*****	*****
JAN	27.40	22.57	24.85	27.24	29.05	31.51	0	0
FEB	26.98	22.34	24.81	26.91	29.18	30.19	0	0
MAR	27.62	23.44	24.68	27.30	29.65	31.95	0	0
APR	27.99	21.17	24.88	28.19	30.67	33.46	1	0
MAY	26.11	20.09	21.84	25.65	29.68	31.76	1	0
JUN	28.02	20.74	22.72	26.43	29.71	39.38	6	0
JUL	32.09	21.82	25.18	29.87	39.60	45.00	14	0
AUG	32.31	24.22	27.14	30.11	36.23	45.00	9	0
SEP	28.86	21.19	23.58	27.39	31.54	38.05	6	0
OCT	27.48	21.57	23.37	27.20	31.05	32.71	0	0
NOV	27.61	22.03	24.72	27.54	29.45	33.11	1	0
DEC	27.62	22.77	25.18	27.30	29.48	31.40	0	0

ANNUAL NUTRIENT AND SEDIMENT CONSTRAINTS  
 \*\*\*\*\*

SIMULATED FRESHWATER INFLOWS LESS THAN NUTRIENT CONSTRAINT ( 860000. ACFT/YR) IN 15 YEARS  
 SIMULATED FRESHWATER INFLOWS LESS THAN SEDIMENT CONSTRAINT ( 355235. ACFT/YR) IN 7 YEARS

ANNUAL FISHERIES HARVEST (KLBS) - GUADALUPE ESTUARY  
 \*\*\*\*\*

SPECIES	AVERAGE	10%<	25%<	50%<	75%<	90%<	# YRS
*****	*****	****	****	****	****	****	*****
WHITE SHRIMP	822.	420.	609.	806.	1007.	1110.	38
BROWN SHRIMP	394.	67.	136.	313.	556.	684.	46
BLUE CRAB	209.	41.	41.	151.	255.	505.	46
OYSTER	477.	54.	54.	351.	638.	1052.	42
BLACK DRUM	25.	0.	4.	16.	41.	58.	45
RED DRUM	72.	31.	41.	56.	87.	124.	42
SEATROUT	57.	19.	27.	44.	78.	115.	49
TOTAL	2007.	1382.	1511.	1723.	2343.	2979.	30

TRANS-TEXAS WATER PROGRAM, WEST CENTRAL STUDY AREA, PHASE 2  
 HDR JOB# = 07755-026-036 DATE = 2/19/98  
 SCENARIO: TASK2B EDWARDS PUMPAGE @ 400,000 AC-FT/YR, RECIR. <= 400 CFS

FRESHWATER INFLOWS (ACFT) - GUADALUPE ESTUARY  
 \*\*\*\*\*

MONTH	AVERAGE	10%<	25%<	50%<	75%<	90%<
*****	*****	****	****	****	****	****
JAN	116908.	11599.	39044.	74152.	124369.	241019.
FEB	124012.	23298.	41180.	78574.	138032.	261502.
MAR	101759.	16376.	30113.	71405.	153806.	225479.
APR	137588.	8909.	23012.	57694.	144176.	424513.
MAY	225459.	18714.	30773.	114176.	339969.	559474.
JUN	218720.	92.	19659.	89152.	244985.	480624.
JUL	114629.	0.	1003.	32538.	126443.	282888.
AUG	52654.	0.	4454.	30086.	68649.	122843.
SEP	169596.	357.	17831.	67065.	185909.	409634.
OCT	159546.	11240.	21919.	73571.	144891.	355340.
NOV	124539.	10749.	35994.	66017.	154766.	290668.
DEC	111312.	12033.	36981.	67761.	138966.	237131.

UPPER SAN ANTONIO BAY SALINITY (PPT)  
 \*\*\*\*\*

MONTH	AVERAGE	10%<	25%<	50%<	75%<	90%<	#V SUB	#V SLB
*****	*****	****	****	****	****	****	*****	*****
JAN	13.67	2.70	8.07	13.07	17.59	22.93	11	9
FEB	12.83	2.18	7.94	12.77	17.66	20.56	7	11
MAR	14.22	4.54	7.68	13.48	19.80	23.90	14	7
APR	15.24	.00	7.79	15.22	22.12	27.93	16	11
MAY	11.38	.00	1.05	9.94	18.48	23.55	18	13
JUN	15.09	.00	2.91	11.51	18.30	45.00	22	9
JUL	23.23	.71	8.52	19.77	41.20	45.00	36	5
AUG	24.00	6.30	13.01	20.10	35.30	45.00	39	0
SEP	16.95	.00	4.83	14.13	23.24	37.84	20	14
OCT	14.27	.23	4.29	13.29	22.78	24.79	16	14
NOV	14.04	1.31	7.43	14.07	18.78	26.39	12	9
DEC	14.27	3.14	8.49	13.35	18.89	23.05	12	7

LOWER SAN ANTONIO BAY SALINITY (PPT)  
 \*\*\*\*\*

MONTH	AVERAGE	10%<	25%<	50%<	75%<	90%<	#V SUB	#V SLB
*****	*****	****	****	****	****	****	*****	*****
JAN	22.60	12.47	17.46	22.12	26.32	31.29	19	0
FEB	21.81	11.98	17.34	21.84	26.39	29.09	18	0
MAR	23.19	14.18	17.10	22.50	28.38	32.20	19	0
APR	23.83	9.43	17.20	24.12	30.53	35.95	25	1
MAY	19.76	7.02	10.93	19.20	27.15	31.87	17	2
JUN	22.49	8.43	12.66	20.66	26.98	45.00	19	2
JUL	29.51	10.61	17.88	28.35	45.00	45.00	35	2
AUG	31.12	15.82	22.06	28.66	42.80	45.00	37	0
SEP	24.71	9.36	14.44	23.10	31.58	45.00	25	1
OCT	22.86	10.16	13.95	22.32	31.15	33.02	22	2
NOV	22.85	11.18	16.87	23.04	27.43	34.51	20	0
DEC	23.14	12.88	17.85	22.37	27.54	31.41	22	0

TRANS-TEXAS WATER PROGRAM, WEST CENTRAL STUDY AREA, PHASE 2  
 HDR JOB# = 07755-026-036                      DATE = 2/19/98  
 SCENARIO: TASK2B EDWARDS PUMPAGE @ 400,000 AC-FT/YR,RECIR. <= 400 CFS

ESPIRITU SANTO BAY SALINITY (PPT)  
 \*\*\*\*\*

MONTH	AVERAGE	10%<	25%<	50%<	75%<	90%<	#V SUB	#V SLB
*****	*****	****	****	****	****	****	*****	*****
JAN	27.48	22.68	25.04	27.25	29.24	31.60	0	0
FEB	27.11	22.44	24.99	27.12	29.27	30.55	0	0
MAR	27.76	23.49	24.87	27.43	30.22	32.03	0	0
APR	28.19	21.23	24.92	28.20	31.24	33.81	1	0
MAY	26.38	20.09	21.95	25.87	29.63	31.87	2	0
JUN	28.38	20.76	22.77	26.56	29.56	45.00	8	0
JUL	32.46	21.79	25.24	30.21	39.66	45.00	14	0
AUG	32.61	24.26	27.22	30.35	37.06	45.00	9	0
SEP	29.12	21.20	23.61	27.72	31.74	38.18	6	0
OCT	27.62	21.58	23.38	27.35	31.53	32.42	0	0
NOV	27.62	22.06	24.76	27.69	29.77	33.13	0	0
DEC	27.73	22.87	25.23	27.37	29.82	31.65	0	0

ANNUAL NUTRIENT AND SEDIMENT CONSTRAINTS  
 \*\*\*\*\*

SIMULATED FRESHWATER INFLOWS LESS THAN NUTRIENT CONSTRAINT ( 860000. ACFT/YR) IN 16 YEARS  
 SIMULATED FRESHWATER INFLOWS LESS THAN SEDIMENT CONSTRAINT ( 355235. ACFT/YR) IN 7 YEARS

ANNUAL FISHERIES HARVEST (KLBS) - GUADALUPE ESTUARY  
 \*\*\*\*\*

SPECIES	AVERAGE	10%<	25%<	50%<	75%<	90%<	# YRS
*****	*****	****	****	****	****	****	*****
WHITE SHRIMP	820.	433.	604.	794.	985.	1110.	37
BROWN SHRIMP	391.	67.	137.	287.	538.	702.	46
BLUE CRAB	208.	41.	41.	151.	253.	513.	45
OYSTER	456.	54.	54.	272.	585.	1069.	41
BLACK DRUM	25.	0.	3.	15.	38.	55.	45
RED DRUM	72.	31.	40.	55.	88.	121.	41
SEATROUT	58.	19.	28.	44.	80.	115.	49
TOTAL	2002.	1113.	1436.	1703.	2343.	2920.	27

TRANS-TEXAS WATER PROGRAM, WEST CENTRAL STUDY AREA, PHASE 2  
 HDR JOB# = 07755-026-036 DATE = 2/19/98  
 SCENARIO: TASK3 SUSTAIN. YLD PUMPAGE =270000 AC-FT/YR,NO RECIRCULATION

FRESHWATER INFLOWS (ACFT) - GUADALUPE ESTUARY

\*\*\*\*\*

MONTH	AVERAGE	10%<	25%<	50%<	75%<	90%<
*****	*****	****	****	****	****	****
JAN	128358.	17120.	51732.	85619.	137796.	250865.
FEB	136054.	29216.	53356.	96589.	152956.	271859.
MAR	114003.	21083.	45050.	79791.	169911.	240627.
APR	149105.	17655.	35862.	69915.	163819.	443740.
MAY	237234.	27720.	42400.	129961.	353858.	571977.
JUN	229503.	92.	35996.	98749.	260621.	497203.
JUL	123991.	0.	6290.	42887.	141045.	303655.
AUG	61677.	0.	11241.	39881.	80721.	143117.
SEP	179225.	1857.	26694.	76984.	193953.	418624.
OCT	169830.	15232.	32982.	88788.	153145.	366041.
NOV	135130.	18131.	45943.	80948.	166210.	299024.
DEC	122058.	20390.	45646.	81241.	152524.	252881.

UPPER SAN ANTONIO BAY SALINITY (PPT)

\*\*\*\*\*

MONTH	AVERAGE	10%<	25%<	50%<	75%<	90%<	#V SUB	#V SLB
*****	*****	****	****	****	****	****	*****	*****
JAN	12.42	2.28	7.13	12.19	15.93	20.88	8	10
FEB	11.62	1.69	7.52	11.31	15.96	17.97	6	11
MAR	12.75	4.04	6.70	12.28	16.49	21.19	10	9
APR	13.50	.00	7.24	13.91	18.63	23.97	12	12
MAY	9.89	.00	.60	8.85	17.82	21.01	17	14
JUN	13.52	.00	2.52	10.53	18.15	29.03	18	9
JUL	20.24	.73	7.84	17.50	29.23	45.00	35	5
AUG	21.26	6.12	12.11	18.06	26.15	45.00	36	0
SEP	14.99	.00	4.39	12.58	20.30	28.50	15	14
OCT	12.68	.05	3.93	12.00	19.78	21.94	11	14
NOV	12.69	1.07	6.84	12.75	16.50	24.12	9	9
DEC	12.89	2.63	7.78	12.44	17.06	20.12	7	7

LOWER SAN ANTONIO BAY SALINITY (PPT)

\*\*\*\*\*

MONTH	AVERAGE	10%<	25%<	50%<	75%<	90%<	#V SUB	#V SLB
*****	*****	****	****	****	****	****	*****	*****
JAN	21.43	12.07	16.59	21.30	24.78	29.38	14	0
FEB	20.68	11.53	16.95	20.48	24.81	26.68	12	0
MAR	21.82	13.71	16.19	21.38	25.30	29.67	15	0
APR	22.19	9.27	16.69	22.90	27.29	32.26	20	1
MAY	18.57	6.96	10.51	18.19	26.54	29.51	17	2
JUN	21.24	8.24	12.30	19.75	26.84	36.97	15	2
JUL	27.48	10.63	17.25	26.24	37.16	45.00	31	2
AUG	28.77	15.65	21.22	26.76	34.29	45.00	32	0
SEP	22.98	9.13	14.04	21.66	28.84	36.48	23	1
OCT	21.40	10.00	13.61	21.12	28.36	30.37	18	2
NOV	21.62	10.95	16.32	21.82	25.31	32.40	16	0
DEC	21.85	12.40	17.19	21.53	25.83	28.68	18	0

TRANS-TEXAS WATER PROGRAM, WEST CENTRAL STUDY AREA, PHASE 2  
 HDR JOB# = 07755-026-036 DATE = 2/19/98  
 SCENARIO: TASK3 SUSTAIN. YLD PUMPAGE =270000 AC-FT/YR,NO RECIRCULATION

ESPIRITU SANTO BAY SALINITY (PPT)

\*\*\*\*\*

MONTH	AVERAGE	10%<	25%<	50%<	75%<	90%<	#V SUB	#V SLB
*****	*****	****	****	****	****	****	*****	*****
JAN	26.92	22.49	24.63	26.86	28.51	30.69	0	0
FEB	26.57	22.23	24.80	26.47	28.52	29.41	0	0
MAR	27.11	23.26	24.44	26.90	28.76	30.83	0	0
APR	27.38	21.16	24.68	27.62	29.70	32.06	1	0
MAY	25.57	20.07	21.75	25.39	29.35	30.75	0	0
JUN	27.55	20.67	22.59	26.13	29.49	34.29	6	0
JUL	30.79	21.80	24.94	29.20	34.38	45.00	8	0
AUG	31.39	24.18	26.82	29.45	33.02	45.00	8	0
SEP	28.17	21.09	23.42	27.03	30.44	34.06	5	0
OCT	26.91	21.50	23.22	26.78	30.21	31.16	0	0
NOV	27.03	21.95	24.50	27.11	28.76	32.13	0	0
DEC	27.12	22.64	24.92	26.97	29.01	30.36	0	0

ANNUAL NUTRIENT AND SEDIMENT CONSTRAINTS

\*\*\*\*\*

SIMULATED FRESHWATER INFLOWS LESS THAN NUTRIENT CONSTRAINT ( 860000. ACFT/YR) IN 14 YEARS  
 SIMULATED FRESHWATER INFLOWS LESS THAN SEDIMENT CONSTRAINT ( 355235. ACFT/YR) IN 4 YEARS

ANNUAL FISHERIES HARVEST (KLBS) - GUADALUPE ESTUARY

\*\*\*\*\*

SPECIES	AVERAGE	10%<	25%<	50%<	75%<	90%<	# YRS
*****	*****	****	****	****	****	****	*****
WHITE SHRIMP	803.	449.	614.	774.	982.	1099.	40
BROWN SHRIMP	391.	83.	145.	267.	514.	675.	49
BLUE CRAB	219.	41.	61.	155.	260.	492.	46
OYSTER	489.	54.	54.	416.	672.	1037.	43
BLACK DRUM	27.	0.	7.	18.	42.	59.	46
RED DRUM	74.	32.	41.	58.	90.	125.	42
SEATROUT	57.	19.	27.	42.	76.	115.	49
*****							
TOTAL	2055.	1399.	1597.	1882.	2369.	2897.	32

TRANS-TEXAS WATER PROGRAM, WEST CENTRAL STUDY AREA, PHASE 2  
 HDR JOB# = 07755-026-036 DATE = 2/19/98  
 SCENARIO: TASK4A SUSTAIN. YIELD PUMPAGE =357000 AC-FT/YR,RECIR. <= 200

FRESHWATER INFLOWS (ACFT) - GUADALUPE ESTUARY

\*\*\*\*\*

MONTH	AVERAGE	10%<	25%<	50%<	75%<	90%<
*****	*****	****	****	****	****	****
JAN	122506.	12328.	45947.	78561.	131785.	252552.
FEB	130028.	23960.	46078.	88253.	145905.	271930.
MAR	107867.	16510.	36728.	77899.	162863.	234424.
APR	143251.	12006.	29059.	61004.	156455.	435540.
MAY	230688.	21025.	34073.	121362.	343192.	562133.
JUN	223666.	92.	26744.	100634.	251621.	489794.
JUL	119039.	0.	2600.	38320.	133022.	296204.
AUG	56752.	0.	5249.	33242.	73648.	134915.
SEP	173833.	1857.	18775.	76808.	189068.	411222.
OCT	163831.	11332.	25556.	79804.	145832.	364635.
NOV	129306.	11195.	39164.	73675.	158764.	302681.
DEC	116276.	13226.	41902.	72549.	144432.	246576.

UPPER SAN ANTONIO BAY SALINITY (PPT)

\*\*\*\*\*

MONTH	AVERAGE	10%<	25%<	50%<	75%<	90%<	#V SUB	#V SLB
*****	*****	****	****	****	****	****	*****	*****
JAN	13.21	2.44	7.48	12.76	16.94	22.54	11	10
FEB	12.31	1.87	7.36	11.90	17.01	19.21	6	11
MAR	13.66	4.31	7.21	12.95	18.02	23.03	13	8
APR	14.53	.00	7.59	14.84	20.41	26.99	15	11
MAY	10.83	.00	.77	9.23	19.49	22.96	17	14
JUN	14.41	.00	2.70	11.05	20.32	37.21	20	9
JUL	22.08	.71	8.31	18.61	37.96	45.00	36	5
AUG	22.88	6.10	12.83	19.59	31.27	45.00	37	0
SEP	16.23	.00	4.73	13.03	22.27	37.75	16	14
OCT	13.80	.19	4.20	12.74	21.21	24.36	16	14
NOV	13.64	1.24	7.21	13.42	17.70	26.41	10	9
DEC	13.77	2.83	8.18	13.14	17.79	22.51	12	7

LOWER SAN ANTONIO BAY SALINITY (PPT)

\*\*\*\*\*

MONTH	AVERAGE	10%<	25%<	50%<	75%<	90%<	#V SUB	#V SLB
*****	*****	****	****	****	****	****	*****	*****
JAN	22.17	12.22	16.91	21.82	25.72	30.93	16	0
FEB	21.33	11.69	16.80	21.03	25.78	27.84	17	0
MAR	22.67	13.97	16.66	22.01	26.72	31.39	16	0
APR	23.15	9.42	17.02	23.77	28.95	35.07	23	1
MAY	19.34	7.01	10.67	18.55	28.09	31.32	17	2
JUN	22.08	8.36	12.47	20.23	28.87	44.58	18	2
JUL	28.68	10.62	17.68	27.27	45.00	45.00	35	2
AUG	30.20	15.64	21.89	28.18	39.06	45.00	33	0
SEP	24.13	9.29	14.36	22.08	30.68	45.00	25	1
OCT	22.42	10.13	13.86	21.81	29.70	32.63	18	2
NOV	22.41	11.11	16.66	22.45	26.43	34.53	18	0
DEC	22.67	12.59	17.57	22.18	26.51	30.91	22	0

TRANS-TEXAS WATER PROGRAM, WEST CENTRAL STUDY AREA, PHASE 2  
 HDR JOB# = 07755-026-036 DATE = 2/19/98  
 SCENARIO: TASK4A SUSTAIN. YIELD PUMPAGE =357000 AC-FT/YR,RECIR. <= 200

ESPIRITU SANTO BAY SALINITY (PPT)  
 \*\*\*\*\*

MONTH	AVERAGE	10%<	25%<	50%<	75%<	90%<	#V SUB	#V SLB
*****	*****	****	****	****	****	****	*****	*****
JAN	27.27	22.56	24.78	27.11	28.96	31.43	0	0
FEB	26.87	22.31	24.73	26.73	28.99	29.96	0	0
MAR	27.51	23.39	24.66	27.20	29.43	31.65	0	0
APR	27.86	21.23	24.83	28.03	30.49	33.39	1	0
MAY	26.06	20.09	21.82	25.56	30.08	31.61	1	0
JUN	27.95	20.73	22.68	26.36	30.45	37.90	6	0
JUL	31.84	21.80	25.15	29.69	38.23	45.00	12	0
AUG	32.10	24.18	27.14	30.13	35.28	45.00	8	0
SEP	28.73	21.17	23.57	27.23	31.31	38.14	5	0
OCT	27.40	21.57	23.34	27.10	30.84	32.23	0	0
NOV	27.44	22.03	24.66	27.41	29.29	33.14	1	0
DEC	27.51	22.73	25.09	27.28	29.33	31.42	0	0

ANNUAL NUTRIENT AND SEDIMENT CONSTRAINTS  
 \*\*\*\*\*

SIMULATED FRESHWATER INFLOWS LESS THAN NUTRIENT CONSTRAINT ( 860000. ACFT/YR) IN 15 YEARS  
 SIMULATED FRESHWATER INFLOWS LESS THAN SEDIMENT CONSTRAINT ( 355235. ACFT/YR) IN 6 YEARS

ANNUAL FISHERIES HARVEST (KLBS) - GUADALUPE ESTUARY  
 \*\*\*\*\*

SPECIES	AVERAGE	10%<	25%<	50%<	75%<	90%<	# YRS
*****	*****	****	****	****	****	****	*****
WHITE SHRIMP	818.	352.	609.	799.	1009.	1110.	38
BROWN SHRIMP	395.	67.	137.	320.	563.	649.	46
BLUE CRAB	210.	41.	50.	151.	257.	502.	46
OYSTER	478.	54.	54.	359.	635.	1044.	42
BLACK DRUM	26.	0.	5.	16.	41.	59.	45
RED DRUM	73.	31.	42.	56.	89.	125.	42
SEATROUT	57.	19.	27.	43.	77.	115.	49
TOTAL	2009.	1359.	1512.	1726.	2348.	2998.	30



TRANS-TEXAS WATER PROGRAM, WEST CENTRAL STUDY AREA, PHASE 2  
 HDR JOB# = 07755-026-036 DATE = 2/19/98  
 SCENARIO: TASK4B SUSTAIN. YLD PUMPAGE =388000 AC-FT/YR,RECIR. <= 400 CFS

FRESHWATER INFLOWS (ACFT) - GUADALUPE ESTUARY  
 \*\*\*\*\*

MONTH	AVERAGE	10%<	25%<	50%<	75%<	90%<
*****	*****	*****	*****	*****	*****	*****
JAN	116769.	11349.	39045.	70561.	125071.	242995.
FEB	123973.	23907.	41722.	79194.	138551.	263895.
MAR	101831.	16354.	31018.	70137.	153917.	226180.
APR	137112.	8543.	23490.	57588.	146059.	424617.
MAY	224706.	18620.	30731.	113889.	339547.	559410.
JUN	217946.	92.	19312.	90377.	244945.	480463.
JUL	114082.	0.	1003.	30800.	127134.	283617.
AUG	52411.	0.	3634.	29776.	68477.	123832.
SEP	169391.	357.	17474.	61428.	185615.	409403.
OCT	159119.	10956.	22183.	74243.	146496.	357619.
NOV	124497.	10671.	36031.	66118.	154979.	292241.
DEC	110949.	11927.	37249.	67471.	139109.	237779.

UPPER SAN ANTONIO BAY SALINITY (PPT)  
 \*\*\*\*\*

MONTH	AVERAGE	10%<	25%<	50%<	75%<	90%<	#V SUB	#V SLB
*****	*****	*****	*****	*****	*****	*****	*****	*****
JAN	13.68	2.70	8.02	13.48	17.46	22.95	11	9
FEB	12.85	2.13	7.86	12.75	17.63	20.38	7	11
MAR	14.24	4.53	7.63	13.77	19.66	24.03	14	7
APR	15.29	.00	7.80	15.26	21.83	27.97	16	11
MAY	11.41	.00	1.04	9.90	19.25	23.60	18	13
JUN	15.18	.00	2.91	11.52	19.97	45.00	22	9
JUL	23.52	.89	8.54	19.86	42.43	45.00	36	5
AUG	24.33	6.46	13.04	20.12	35.56	45.00	39	0
SEP	17.06	.00	4.84	14.15	23.34	38.20	19	14
OCT	14.34	.23	4.49	13.20	22.75	26.47	16	14
NOV	14.08	1.32	7.44	14.07	18.83	26.56	12	9
DEC	14.32	3.12	8.51	13.28	18.71	22.80	13	7

LOWER SAN ANTONIO BAY SALINITY (PPT)  
 \*\*\*\*\*

MONTH	AVERAGE	10%<	25%<	50%<	75%<	90%<	#V SUB	#V SLB
*****	*****	*****	*****	*****	*****	*****	*****	*****
JAN	22.61	12.46	17.42	22.49	26.20	31.31	19	0
FEB	21.83	11.94	17.27	21.82	26.36	28.92	19	0
MAR	23.21	14.17	17.06	22.77	28.25	32.31	19	0
APR	23.87	9.40	17.21	24.15	30.27	35.99	25	1
MAY	19.79	7.02	10.92	19.16	27.87	31.92	17	2
JUN	22.57	8.43	12.66	20.67	28.53	45.00	19	2
JUL	29.72	10.78	17.90	28.43	45.00	45.00	35	2
AUG	31.32	15.96	22.09	28.68	43.05	45.00	37	0
SEP	24.80	9.36	14.46	23.12	31.68	45.00	25	1
OCT	22.91	10.17	14.13	22.24	31.12	34.58	22	2
NOV	22.88	11.18	16.87	23.05	27.48	34.67	20	0
DEC	23.19	12.86	17.87	22.31	27.36	31.18	22	0

TRANS-TEXAS WATER PROGRAM, WEST CENTRAL STUDY AREA, PHASE 2  
 HDR JOB# = 07755-026-036 DATE = 2/19/98  
 SCENARIO: TASK4B SUSTAIN. YLD PUMPAGE =388000 AC-FT/YR,RECIR. <= 400 CFS

ESPIRITU SANTO BAY SALINITY (PPT)  
 \*\*\*\*\*

MONTH	AVERAGE	10%<	25%<	50%<	75%<	90%<	#V SUB	#V SLB
JAN	27.48	22.67	25.02	27.43	29.19	31.61	0	0
FEB	27.11	22.42	24.95	27.11	29.26	30.47	0	0
MAR	27.77	23.48	24.85	27.56	30.16	32.08	0	0
APR	28.21	21.22	24.93	28.21	31.11	33.82	1	0
MAY	26.39	20.09	21.94	25.85	29.97	31.90	2	0
JUN	28.42	20.76	22.77	26.56	30.29	45.00	8	0
JUL	32.54	21.88	25.25	30.24	40.20	45.00	15	0
AUG	32.75	24.33	27.24	30.36	37.17	45.00	11	0
SEP	29.16	21.20	23.62	27.73	31.78	38.34	6	0
OCT	27.65	21.59	23.46	27.31	31.52	33.16	0	0
NOV	27.64	22.07	24.76	27.69	29.79	33.20	0	0
DEC	27.76	22.86	25.24	27.34	29.74	31.54	0	0

ANNUAL NUTRIENT AND SEDIMENT CONSTRAINTS  
 \*\*\*\*\*

SIMULATED FRESHWATER INFLOWS LESS THAN NUTRIENT CONSTRAINT ( 860000. ACFT/YR) IN 16 YEARS  
 SIMULATED FRESHWATER INFLOWS LESS THAN SEDIMENT CONSTRAINT ( 355235. ACFT/YR) IN 7 YEARS

ANNUAL FISHERIES HARVEST (KLBS) - GUADALUPE ESTUARY  
 \*\*\*\*\*

SPECIES	AVERAGE	10%<	25%<	50%<	75%<	90%<	# YRS
WHITE SHRIMP	820.	409.	604.	800.	986.	1110.	37
BROWN SHRIMP	391.	67.	137.	286.	537.	695.	46
BLUE CRAB	208.	41.	41.	151.	253.	514.	45
OYSTER	456.	54.	54.	272.	595.	1069.	41
BLACK DRUM	25.	0.	3.	16.	39.	55.	45
RED DRUM	72.	29.	40.	55.	84.	121.	41
SEATROUT	57.	19.	27.	44.	79.	115.	49
TOTAL	2000.	1116.	1427.	1697.	2338.	2925.	27

**Report 3**

**Modification of Principal Spillways at  
Existing Flood Control Projects for  
Recharge Enhancement**

**TRANS-TEXAS WATER PROGRAM  
WEST CENTRAL STUDY AREA**

**PHASE 2**

**MODIFICATION OF PRINCIPAL SPILLWAYS AT  
EXISTING FLOOD CONTROL PROJECTS FOR  
RECHARGE ENHANCEMENT**

**San Antonio River Authority  
San Antonio Water System  
Edwards Aquifer Authority  
Guadalupe-Blanco River Authority  
Lower Colorado River Authority  
Bexar Metropolitan Water District  
Nueces River Authority  
Canyon Lake Water Supply Corporation  
Bexar-Medina-Atascosa Counties WCID No. 1  
Texas Natural Resource Conservation Commission  
Texas Parks and Wildlife Department  
Texas Water Development Board**

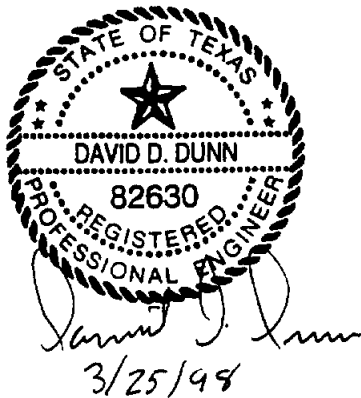

March 1998

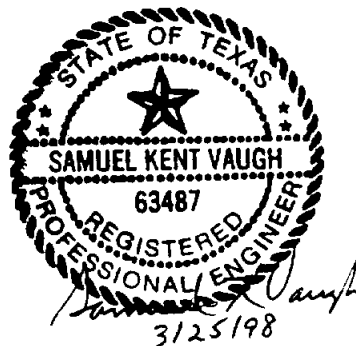

**MODIFICATION OF PRINCIPAL SPILLWAYS AT  
EXISTING FLOOD CONTROL PROJECTS FOR  
RECHARGE ENHANCEMENT**

**TABLE OF CONTENTS**

<b>Section</b>	<b>Page</b>
<b>1.0 INTRODUCTION.....</b>	<b>1-1</b>
<b>2.0 SITE SELECTION.....</b>	<b>2-1</b>
<b>3.0 FLOOD HYDROLOGY ANALYSIS .....</b>	<b>3-1</b>
<b>3.1 Data Collection and Model Development .....</b>	<b>3-1</b>
<b>3.2 Performance of Flood Retarding Structures Without Considering         Recharge .....</b>	<b>3-4</b>
<b>3.3 Performance of Flood Retarding Structures Considering Recharge.....</b>	<b>3-6</b>
<b>3.4 Evaluation of Principal Spillway Constriction.....</b>	<b>3-6</b>
<b>4.0 RECHARGE ENHANCEMENT POTENTIAL.....</b>	<b>4-1</b>
<b>5.0 IMPLEMENTATION .....</b>	<b>5-1</b>
<b>6.0 SUMMARY .....</b>	<b>6-1</b>

## LIST OF FIGURES

<b>Figure No.</b>		<b>Page</b>
2-1	Location Map, Potential Sites for FRS Outlet Modifications.....	2-4
3-1	Typical NRCS Flood Retardation Structure .....	3-3
3-2	Comal Site 4 Unconstricted Principal Spillway Ratings .....	3-8
3-3	Salado Site 11 Unconstricted and Constricted Principal Spillway Ratings.....	3-9
3-4	Salado Site 13A Unconstricted and Constricted Principal Spillway Ratings.....	3-10
3-5	Comal Site 4 Flood Pool Hydrograph.....	3-12
3-6	Salado Site 11 Flood Pool Hydrograph .....	3-13
3-7	Salado Site 13A Flood Pool Hydrograph.....	3-14

## LIST OF TABLES

<b>Table No.</b>		<b>Page</b>
2-1	Summary of NRCS Flood Control Structures on the Edwards Aquifer Recharge Zone .....	2-1
3-1	Summary of Principal Spillway and Flood Storage Parameters .....	3-4
3-2	Flood Hydrology Parameters, 100-Year Design Storm Event.....	3-5
3-3	Summary of Flood Structures Performance without Recharge Considered .....	3-5
3-4	Summary of Flood Structures Performance with Recharge Considered .....	3-7
3-5	Summary of Flood Structures Performance with Constricted Principal Spillways and Consideration of Recharge .....	3-11
4-1	Recharge Enhancement Potential, Single Storm Event Analysis, Salado Creek Site 11 .....	4-1
4-2	Summary of Recharge Enhancement for Salado Creek Site 11 and Site 13A.....	4-4
5-1	Project Cost Estimate for Modification of Principal Spillway, Per Flood Control Structure.....	5-1
5-2	Recharge Enhancement Cost Summary .....	5-2

## 1.0 INTRODUCTION

Flood control structures located in the Salado Creek, York Creek, Comal River, and Upper San Marcos River watersheds have been designed and constructed by the Natural Resources Conservation Service (formerly Soil Conservation Service) in cooperation with local sponsors. Many of the flood control structures were constructed on the Edwards Aquifer recharge zone and provide additional recharge to the aquifer by impounding floodwater and allowing it to infiltrate into the aquifer over a period of several days.

The principal spillways of Natural Resources Conservation Service (NRCS) flood control structures are designed to evacuate the floodwater retarding pool within a 10-day period, commencing from the time the maximum flood pool elevation is attained. This standard accounts for the possibility of successive major storm events.<sup>1</sup> The floodwater retarding pool consists of that portion of the reservoir allotted to the temporary impoundment of floodwater with its upper limit being the elevation of the auxiliary or emergency spillway crest. In practice, the criteria are considered to be satisfied if the floodwater retarding pool is evacuated to below 15-percent of the flood pool capacity. Significant recharge rates which contribute to the evacuation of floodwater from the reservoirs have been observed at structures located in the Edwards Aquifer recharge zone.<sup>2</sup> In the original design of many of these structures, the rate of recharge in the reservoir pool area was not considered in calculating the required spillway discharge capacity for meeting the 10-day drawdown design criteria. If the actual drawdown time is less than 10 days because of recharge in the reservoir pool area, the principal spillway could be modified to reduce or eliminate releases in order to enhance recharge and still satisfy the 10-day drawdown design criteria. The primary objective of this study is to assess the potential for enhancement of recharge to the Edwards Aquifer by modifying the principal spillways of three selected flood control structures in the Guadalupe-San Antonio River Basin.

---

<sup>1</sup> Soil Conservation Service, "Earth Dams and Reservoirs," Technical Release No. 60, October 1990.

<sup>2</sup> San Antonio River Authority, "Flood Control and Edwards Recharge at Salado Site 8, Storm Event on April 4, 1991," videotape.



(This page intentionally left blank.)

## 2.0 SITE SELECTION

A total of 22 flood control structures have been constructed on the Edwards Aquifer recharge zone in the Salado Creek, York Creek, Comal River, and Upper San Marcos River watersheds. Table 2-1 characterizes these structures by watershed, drainage area controlled, and floodwater storage capacity. Of the four watersheds considered, the Salado Creek watershed has the most extensive program of NRCS flood control structures on the Edwards Aquifer recharge zone.

Watershed	Structure I.D.	Drainage Area (square miles)	Storage Capacity <sup>1</sup> (acre-feet)
Salado Creek	4	5.51	1,982
	5	8.86	3,293
	6	4.58	1,490
	8	11.18	4,178
	9	2.37	1,026
	10	4.78	1,846
	11	6.56	2,598
	12	12.70	4,875
	13A	3.28	1,441
13B	2.53	1,093	
York Creek	1	12.93	3,178
	2	2.80	586
Comal River	1	18.52	3,793
	2	30.15	7,878
	3	11.56	3,422
	4	12.97	3,604
	5	1.38	394
Upper San Marcos River	1	33.57	8,683
	2	4.35	1,275
	3	5.67	1,011
	4	20.17	4,788
	5	14.41	3,167
<b>Total</b>		<b>230.83</b>	<b>65,601</b>
Notes:			
1. Storage capacity presented is the total storage capacity, including sediment reserve, at the auxiliary spillway crest elevation.			

For this study, three flood control structures were to be selected for detailed analyses of their potential for modification for recharge enhancement. Flood control structures in the Upper San Marcos River watershed were designed considering the recharge rates that exist in the reservoir pool areas and, therefore, were not selected for further study. Flood control structures in the upper portion of the York Creek watershed were designed as NRCS Class A structures, which do not have spillway capacities as large as the Class C structures constructed in the other watersheds. In some cases, the York Creek structures may not meet current Hydrologic Criteria for Dams as required by the Texas Natural Resource Commission.<sup>1</sup> Based on the present hydraulic capacity of the York Creek structures, further reduction of the principal spillway capacity at these structures may not be feasible.

Five flood control structures in the Comal River watershed are located on the Edwards Aquifer recharge zone. Based on personal interviews with local NRCS representatives, Site 3 and Site 4 are the most likely sites at which to implement reductions in the hydraulic capacity of the principal spillways. Subordination agreements with adjacent landowners that allow for constriction of the principal spillway are presently in place at these sites. A review of NRCS design files obtained from the NRCS state office indicated that recharge was considered in the design of Site 3. No data could be located in the design files that indicated that recharge was considered in the design of Site 4.

Flood control structures in the Salado Creek watershed appear to offer the most potential for additional recharge enhancement by modifying the principal spillways. A total of ten of the Salado Creek flood control structures are located on the Edwards Aquifer recharge zone. Of these ten structures, six were not considered for further study due to existing residential development or other commercial activity around the perimeter of the flood pool, or because of downstream water right issues. Reduction of the principal spillway capacity at one of these structures would produce higher flood levels in the upstream pool potentially impacting upstream development, and could reduce water available for diversion downstream of the structure. Of the remaining four Salado Creek structures, the principal spillway discharge from Site 8 has been observed to recharge prior to arriving at the next downstream structure. Therefore, the recharge

---

<sup>1</sup> Texas Natural Resource Conservation Commission, "Guidelines for Operation and Maintenance of Dams in Texas," September 1990.

of floodwater is considered to be near its maximum potential for this structure and a reduction in spillway capacity would not offer additional recharge benefit. In the Salado Creek watershed, Site 11 and Site 13A appear to have the least potential conflicts associated with reduction of the principal spillway discharge capacity.

For purposes of this study, Salado Creek Site 11, Salado Creek Site 13A, and Comal River Site 4 were selected for detailed study. These three sites appear to offer the greatest potential for modification of the principal spillway and enhancement of recharge within their respective reservoir pools. The locations of the three selected sites in the Salado Creek and Comal River watersheds are shown in Figure 2-1.

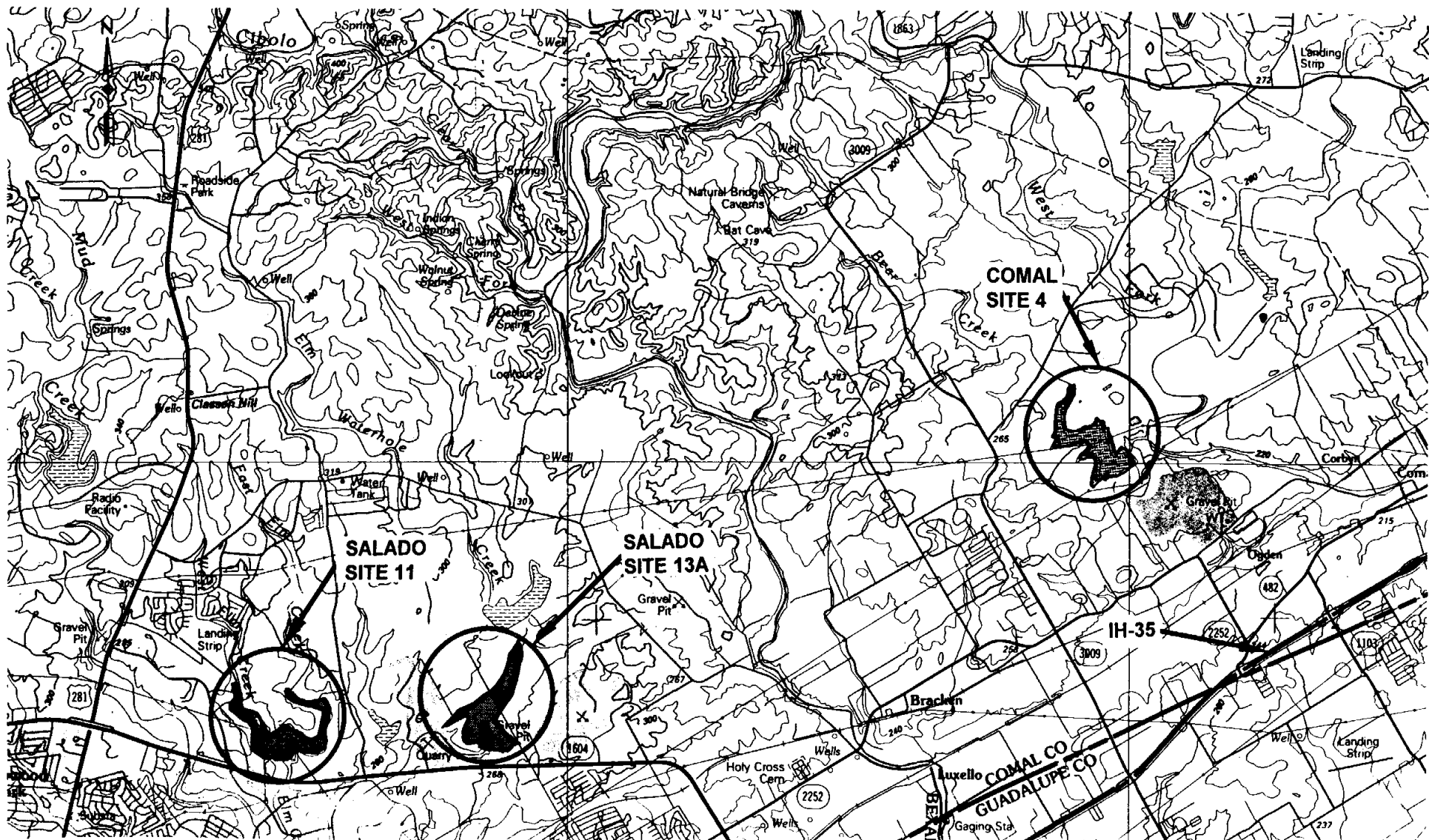

**SITE SELECTED  
FOR ANALYSIS**

**APPROXIMATE  
SCALE IN FEET**



**TRANS TEXAS WATER PROGRAM  
WEST CENTRAL STUDY AREA**

**LOCATION MAP  
POTENTIAL SITES FOR  
OUTLET MODIFICATIONS**



HDR Engineering, Inc.

**FIGURE 2 - 1**

*MODIFICATION OF PRINCIPAL SPILLWAYS AT  
EXISTING FLOOD CONTROL PROJECTS FOR  
RECHARGE ENHANCEMENT*

### **3.0 FLOOD HYDROLOGY ANALYSIS**

Any modification of the principal spillway at the selected sites is contingent upon the structure meeting the requirements of the original design criteria. More specifically, the maximum water-surface elevation attained under a simulation of the design storm event must be lower than the crest of the emergency spillway, and the floodwater retarding pool must evacuate to less than 15 percent of the total floodwater capacity within 10 days.

A flood hydrology model was developed for each site to assess the performance of the principal spillway as constructed, and under various degrees of constriction. The flood hydrology model for each site was utilized to simulate the design storm event, compute the hydraulic rating for the principal spillway, and compute the maximum water-surface elevation and drawdown time for the design storm event. Elevation-recharge rate relationships were developed for each site to estimate the amount of recharge from the reservoir pool that might occur during the design storm event. Spillway hydraulic capacity and the elevation-recharge relationships were used to determine the reduction of the principal spillway capacity that could occur and still satisfy allowable flood elevation constraints and 10-day drawdown design criteria. Specific tasks performed to evaluate the effects of principal spillway capacity reductions on flood hydrology for each site include:

1. Collect structure design and watershed data;
2. Develop flood hydrology model;
3. Compute the time to evacuate the retarding pool without considering recharge;
4. Develop an elevation-recharge rate relationship;
5. Compute the time to evacuate the retarding pool considering recharge; and
6. Calculate the reduction of the principal spillway capacity that could be made and still meet the hydrologic design criteria considering recharge.

#### **3.1 Data Collection and Model Development**

As-built structure information and flood hydrology parameters (drainage area, runoff curve number, time of concentration, etc.) used in the design of each site were obtained from the NRCS. The flood hydrology information was obtained from archived records, some of which were incomplete and inconclusive regarding parameters ultimately selected to develop the design flood hydrology model for each site. When a final design parameter was in doubt, the most

reasonable value was selected and supported with information from other sources such as topographic maps and soil surveys.

The flood hydrology parameters were used to develop a SITES<sup>1</sup> model for each flood control structure to calculate a principal spillway discharge rating table, simulate the design storm, route the resulting runoff hydrograph, and compute the maximum water-surface elevation and drawdown time. The SITES computer program is the current version of the NRCS DAMS2 program, which was utilized in the original design of most of the structures. The DAMS2 and SITES programs perform flood hydrology computations in accordance with the procedures outlined in TR-60<sup>2</sup> and Chapter 21 of NEH-4<sup>3</sup>. These references present criteria and procedures for developing principal spillway hydrographs (PSHs) for the design of flood retarding structures. The PSH adopted by the NRCS is a function of the direct runoff mass curve from the 100-year, 10-day precipitation depth, and the direct runoff volume from the 100-year, 24-hour precipitation depth. The SITES model also calculates principal spillway rating tables from dimensions and elevations of principal spillway appurtenances.

The NRCS utilizes a standard principal spillway configuration for most flood retarding structures. This configuration includes a tower drop inlet structure which is controlled by an overflow weir. Flow from the inlet structure is conveyed by a circular conduit through the dam and discharged to the channel downstream. The overflow weir usually is sized to control the flow up to an elevation about 1.5 to 2 feet above the weir crest, above which the outlet conduit controls flow through the principal spillway. The volume contained between the reservoir bottom and the crest of the principal spillway weir usually is considered “dead” storage, and is reserved for sediment accumulation over the life of the structure. The design flood routings begin with the storage set equal to the principal spillway crest elevation. Figure 3-1 presents a schematic drawing of a typical NRCS flood retardation structure.

The Texas Natural Resource Conservation Commission requires water rights permits for dams that impound more than 200 acre-feet of water. For sites where hydrologic design

---

<sup>1</sup> Natural Resources Conservation Service, “SITES, Water Resource Site Analysis Computer Program,” December 1996.

<sup>2</sup> Soil Conservation Service, “Earth Dams and Reservoirs,” Technical Release No. 60, October 1990.

<sup>3</sup> Soil Conservation Service, “SCS National Engineering Handbook, Section 4, Hydrology,” March 1985.

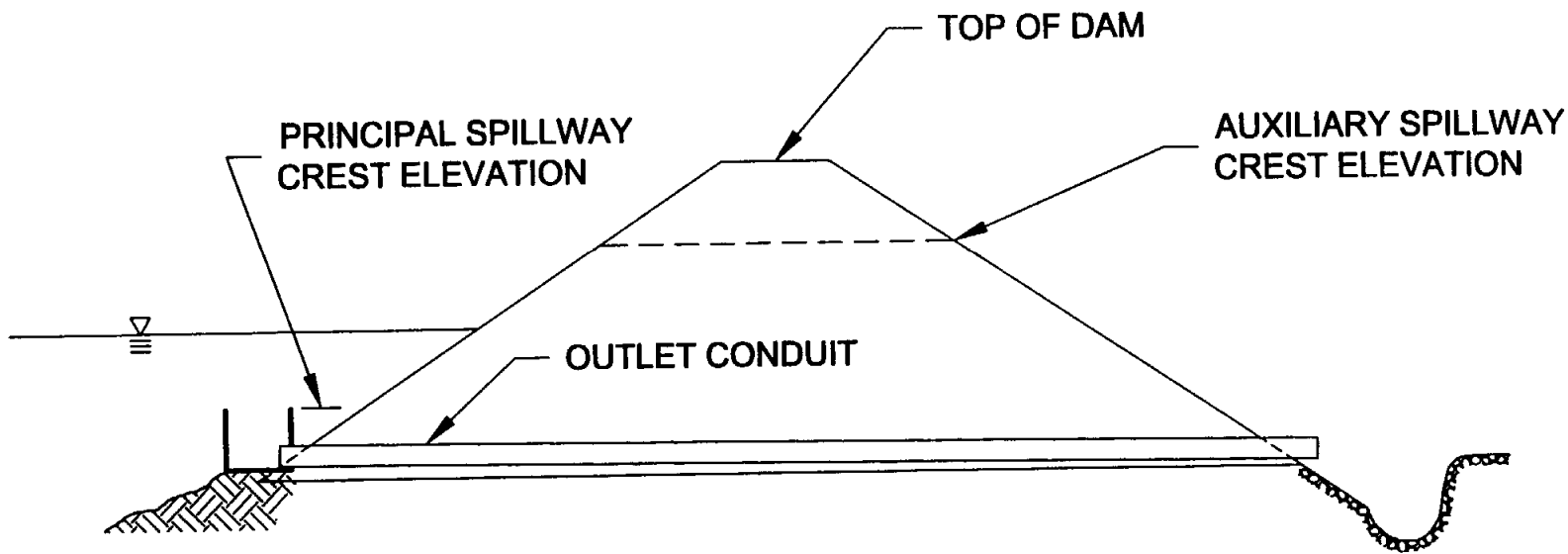

MODIFICATION OF PRINCIPAL SPILLWAYS AT  
 EXISTING FLOOD CONTROL PROJECTS FOR  
 RECHARGE ENHANCEMENT



HDR Engineering, Inc.

TRANS TEXAS WATER PROGRAM /  
 WEST CENTRAL STUDY AREA

**TYPICAL NRCS FLOOD  
 RETARDATION STRUCTURE**

FIGURE 3 - 1



constraints cause the structure to impound more than 200 acre-feet below the principal spillway crest elevation, the NRCS has incorporated portholes in the sides of the drop inlet tower. These portholes are positioned at the elevation corresponding to 200 acre-feet storage to allow automatic drawdown to below this elevation. These portholes usually have an insignificant effect on the outflow rating of the principal spillway. The Comal River Site 4 includes these portholes. They were not included in the flood routings. Pertinent data used to compute the principal spillway rating and determine drawdown times are presented in Table 3-1.

<b>Site Characteristic</b>	<b>Site</b>		
	<b>Comal River Site 4</b>	<b>Salado Creek Site 11</b>	<b>Salado Creek Site 13A</b>
Principal Spillway Crest Elevation (ft-msl)	763.4	845.3	861.8
Emergency Spillway Crest Elevation (ft-msl)	798.8	877.8	877.0
Storage at Principal Spillway Crest (acft)	298	84	128
Storage at Emergency Spillway Crest (acft)	3,605	2,598	1,441
Elevation at 15% Flood Control Storage (ft-msl)	774.8	857.3	866.4
Weir Length (ft)	15	15	16.3
Conduit Diameter (inches)	30	30	36
Conduit Length (ft)	340	200	230
Conduit Tailwater Elevation (ft-msl)	739.2	837.0	849.0

### **3.2 Performance of Flood Control Structures without Considering Recharge**

The design inflow hydrograph for each site was computed using the SITES model and routed through the existing flood control structure. Recharge from the reservoir pool was not considered in the initial flood routings. The flood hydrology model parameters for each of the three selected sites are presented in Table 3-2. The initial flood routings are summarized in Table 3-3.

As shown in Table 3-3, Comal River Site 4 does not meet either the maximum water surface elevation or the 10-day drawdown criteria. Because recharge was considered in the design of Comal River Site 3, recharge likely was considered in the design of Comal River Site 4. Salado Creek Site 11 meets the maximum water-surface elevation criteria, but does not

meet the 10-day drawdown criteria. Salado Creek Site 13A does not meet the maximum water-surface elevation criteria, but does meet the 10-day drawdown criteria.

Site	Drainage Area (sq. mi.)	SCS Runoff CN	Time of Conc. (hrs)	Precipitation Depth	
				24-hr Total (inches)	10-day Total (inches)
Comal River Site 4	12.97	77	3.6	9.8	16.0
Salado Creek Site 11	6.56	81	2.3	9.8	16.0
Salado Creek Site 12 <sup>1</sup>	12.70	79	2.8	9.8	16.0
Salado Creek Site 13A <sup>2</sup>	3.28	81	1.0	9.8	16.0

Notes:  
 1. Upstream of Salado Site 13A.  
 2. Drainage area shown is uncontrolled area; it does not include area controlled by Site 12.

Site	Peak Inflow (cfs)	Peak Outflow (cfs)	Emergency Spillway Crest Elevation (ft-msl)	Maximum Water Surface Elevation (ft-msl) <sup>1</sup>	Drawdown Time (days) <sup>2</sup>
Comal River Site 4	8,323	148	798.8	801.1	14.1
Salado Creek Site 11	6,927	139	877.8	877.7	10.7
Salado Creek Site 12 <sup>3</sup>	11,934	148	936.2	935.1	5.7
Salado Creek Site 13A <sup>4</sup>	5,963	166	877.0	878.4	8.2

Notes:  
 1. If higher than the elevation of the emergency spillway, the routing was performed assuming that the emergency spillway is blocked.  
 2. Does not include recharge from flood control pool, except for Site 12. Drawdown time is measured from time of peak water-surface elevation in flood pool to 15-percent flood pool storage.  
 3. Peak outflow is outflow through principal spillway only, and was computed with recharge considered. Peak outflow and drawdown time without recharge considered are 153 cfs and 18.5 days, respectively.  
 4. Peak inflow is computed considering recharge at Site 12, which does not substantially reduce the peak inflow, but reduces the length of time inflow is received from Site 12.

Salado Creek Site 12 is a flood control structure upstream of Site 13A, and controls 12.70 square miles of the total 15.98 square mile watershed. Site 12 was included in the Site 13A flood hydrology model. Neither Site 12 or Site 13A meet the 10-day drawdown criteria without consideration of recharge, but Site 12 does meet the requirement with recharge considered. Recharge from the Site 12 flood control pool was reflected in all flood routings for

considered. Recharge from the Site 12 flood control pool was reflected in all flood routings for Site 13A. Site 12 was not studied (beyond inclusion in the Site 13A model), because a quarry operation is located within and adjacent to its flood control pool, and constriction of the principal spillway could be problematic.

### **3.3 Performance of Flood Control Structures Considering Recharge**

An elevation-recharge rate relationship was developed for each site, based upon the elevation-area inundated relationship for each site and an estimate of the permeability of the soil cover in the flood-control pool. Soil cover permeabilities were estimated from the Soil Survey of Comal and Hays Counties<sup>4</sup> and the Soil Survey of Bexar County<sup>5</sup>. This method for estimating recharge has been shown to be applicable for recharge reservoirs in the Nueces River Basin<sup>6</sup>. The method does not take into account the increase in head on the soil cover as the reservoir stage rises and the increase in recharge rate that would result. It also does not take into account that much of the native soil was excavated from the reservoir pool area of many sites. Therefore, the elevation-recharge rate estimates likely are less than actual recharge rates.

The elevation-recharge rating was combined with the principal spillway rating table computed by the SITES model to develop a combined elevation-recharge-outflow rating for each site. The flood routings are summarized in Table 3-4. Comal Site 4 failed to meet both the maximum water-surface elevation and the 10-day drawdown criteria when recharge was considered.

### **3.4 Evaluation of Principal Spillway Constriction**

Constriction of the principal spillway will require either constricting the entrance into the drop inlet, constricting the entrance into the conduit, or constricting the exit of the conduit and could be accomplished using some form of orifice plate, valve, or sluice gate. A feasible approach that would allow the degree of constriction to be reduced or increased, based on observation of performance, is installation of a removable orifice plate at the entrance to the

---

<sup>4</sup> Soil Conservation Service, "Soil Survey of Comal and Hays Counties, Texas," June 1984.

<sup>5</sup> Soil Conservation Service, "Soil Survey of Bexar County, Texas," June 1991.

<sup>6</sup> HDR Engineering, Inc., "Edwards Aquifer Recharge Enhancement Project, Phase IVA, Nueces River Basin," June 1994.

outlet conduit. This plate could be adjusted up or down to modify the degree of constriction of the principal spillway.

Site	Principal Spillway Peak Outflow (cfs)	Peak Recharge Rate (cfs)	Emergency Spillway Crest Elevation (ft-msl)	Maximum Water Surface Elevation (ft-msl) <sup>1</sup>	Drawdown Time (days)
Comal River Site 4	147.6	30.5	798.8	800.7	12.4
Salado Creek Site 11	136.7	140.4	877.8	876.5	6.1
Salado Creek Site 13A	161.2	91.0	877.0	876.6	7.3

Note:  
1. If higher than the elevation of the emergency spillway, the routing was performed assuming that the emergency spillway is blocked.

A series of constricted principal spillway elevation-discharge ratings were developed for each site, consistent with the methods described in NEH-5.<sup>7</sup> The ratings under low levels of constriction agree closely with those calculated by the SITES program. These ratings were combined with the elevation-recharge ratings to develop combined recharge-spillway ratings, and were entered into the SITES program. The opening that resulted in approximately a 10-day drawdown time was selected. Figures 3-2, 3-3, and 3-4 illustrate the principal spillway ratings utilized for Comal River Site 4, Salado Creek Site 11, and Salado Creek Site 13A, respectively.

The flood routings for Salado Creek Sites 11 and 13A are summarized in Table 3-5. Comal River Site 4 failed to meet either the maximum water-surface elevation or the 10-day drawdown criteria without constriction of the spillway and was eliminated from further consideration. Both Salado Creek sites were able to meet the 10-day drawdown criteria, but Site 13A does not meet the maximum water-surface elevation criteria. If the spillway is constricted at Salado Creek Site 13A, modification of the auxiliary spillway to include an erodible berm (fuse plug) may be required to meet the NRCS design criteria. This berm could be designed to erode (fail) when overtopped, thereby allowing floods larger than the design event to pass

<sup>7</sup> Soil Conservation Service, "National Engineering Handbook, Section 5, Hydraulics," 1956.

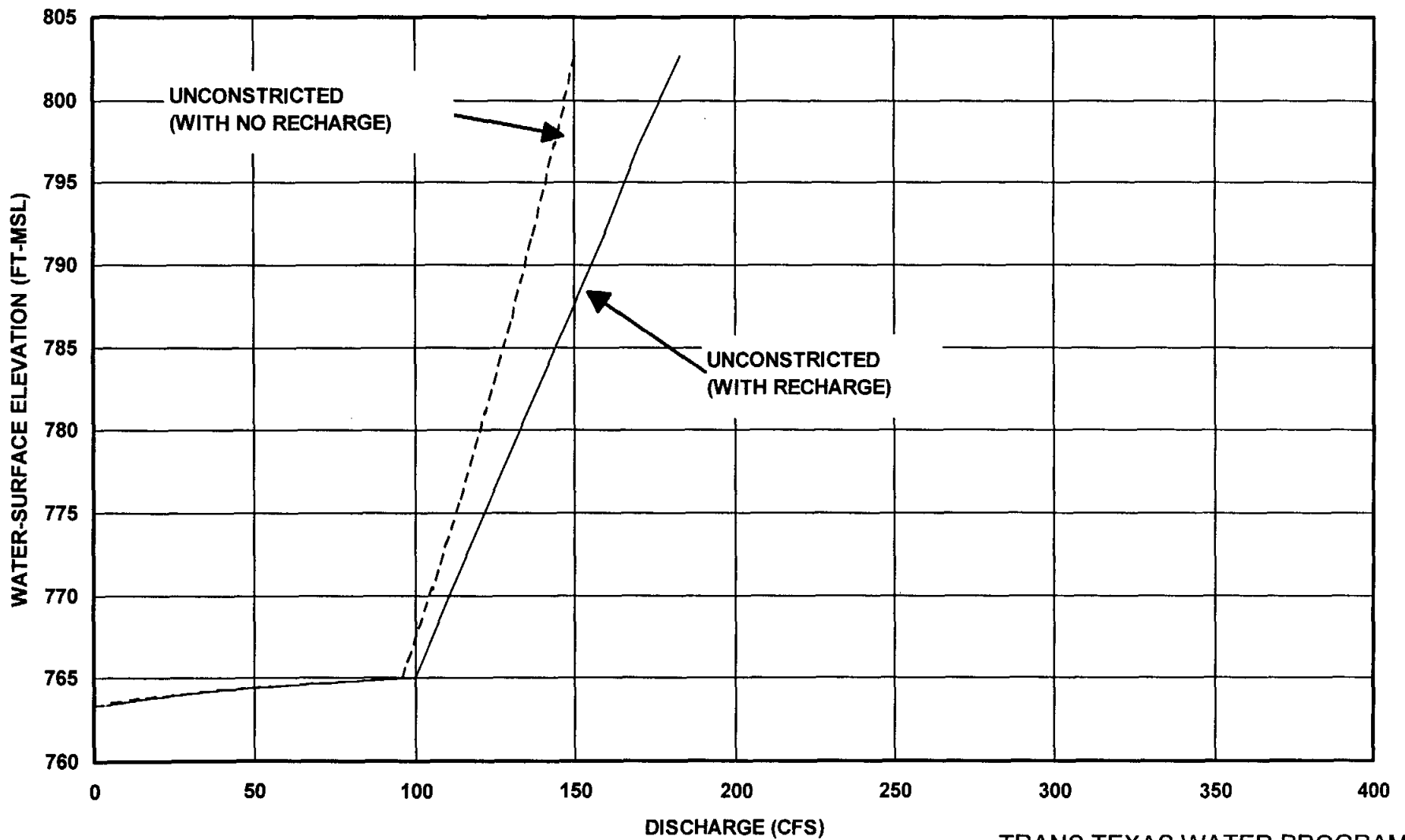

TRANS TEXAS WATER PROGRAM /  
WEST CENTRAL STUDY AREA

**COMAL SITE 4  
UNCONSTRICTED PRINCIPAL  
SPILLWAY RATINGS**

FIGURE 3 - 2

*MODIFICATION OF PRINCIPAL SPILLWAYS AT  
EXISTING FLOOD CONTROL PROJECTS FOR  
RECHARGE ENHANCEMENT*



HDR Engineering, Inc.

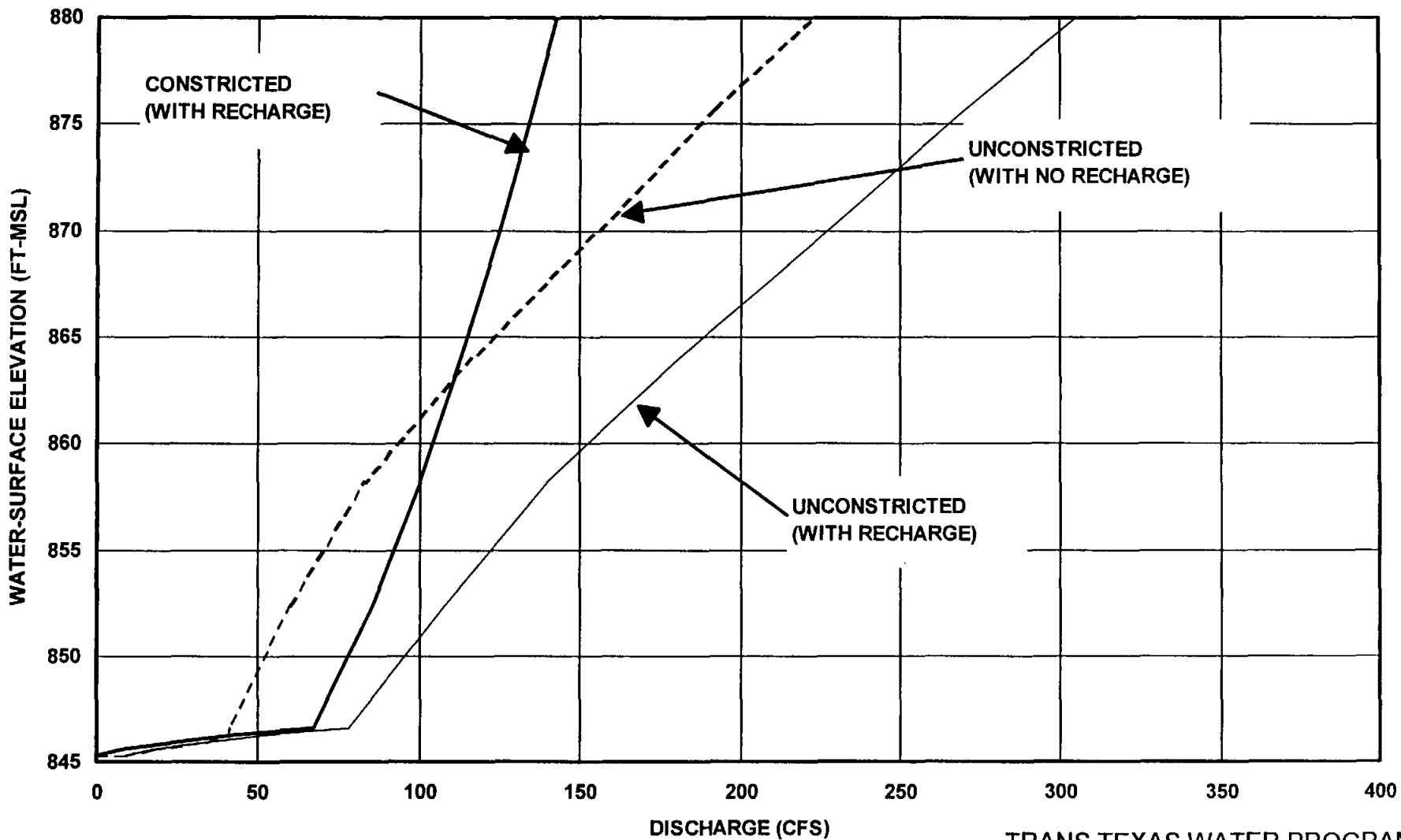

TRANS TEXAS WATER PROGRAM /  
WEST CENTRAL STUDY AREA

**SALADO SITE 11  
UNCONSTRICTED AND  
CONSTRICTED PRINCIPAL  
SPILLWAY RATINGS**  
FIGURE 3 - 3

MODIFICATION OF PRINCIPAL SPILLWAYS AT  
EXISTING FLOOD CONTROL PROJECTS FOR  
RECHARGE ENHANCEMENT



HDR Engineering, Inc.

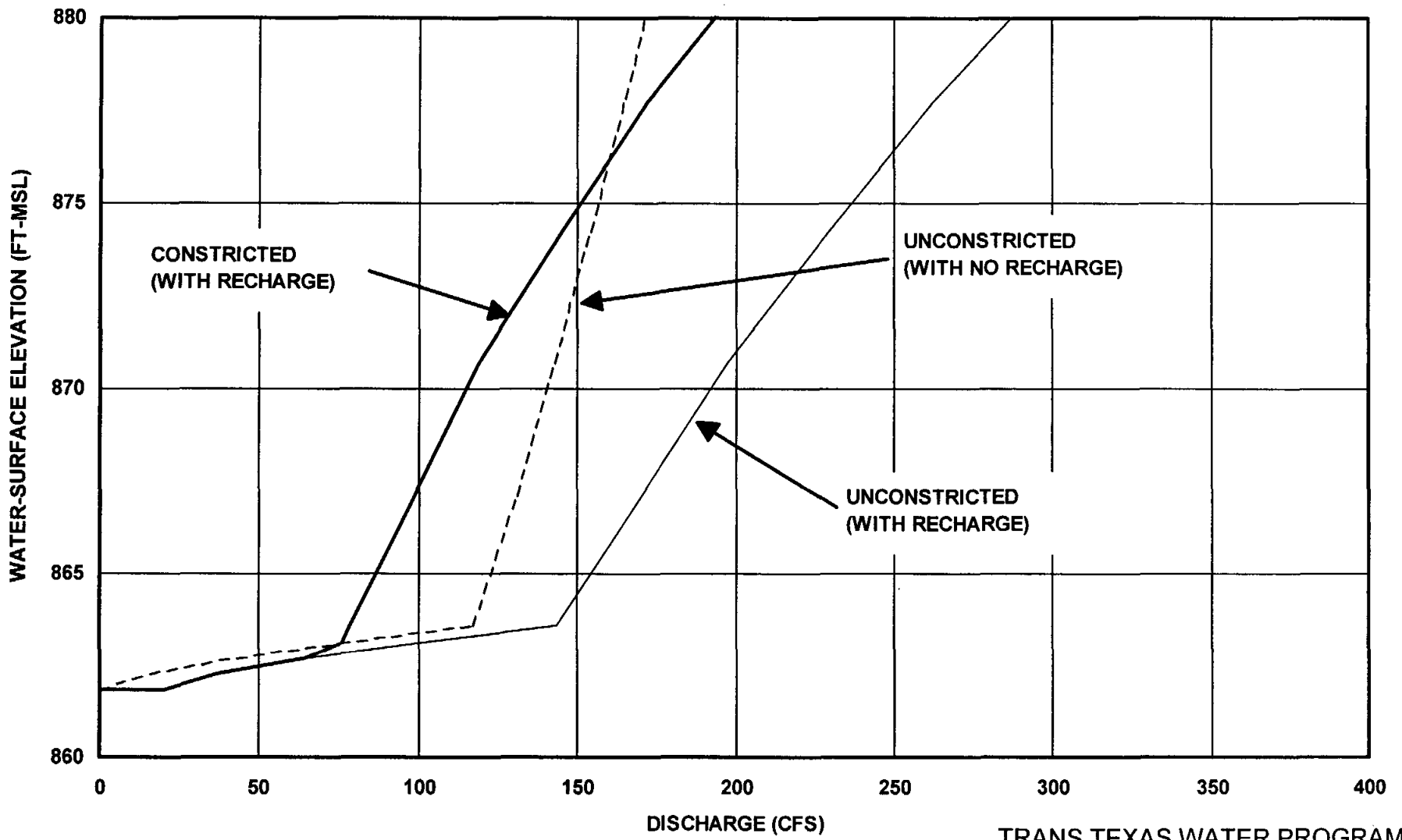

TRANS TEXAS WATER PROGRAM /  
WEST CENTRAL STUDY AREA

**SALADO SITE 13A  
UNCONSTRICTED AND  
CONSTRICTED PRINCIPAL  
SPILLWAY RATINGS**  
FIGURE 3 - 4

MODIFICATION OF PRINCIPAL SPILLWAYS AT  
EXISTING FLOOD CONTROL PROJECTS FOR  
RECHARGE ENHANCEMENT



HDR Engineering, Inc.

unimpeded through the emergency spillway. Figures 3-5, 3-6, and 3-7 present the stage hydrographs for each of the scenarios analyzed.

Site	Principal Spillway Peak Outflow (cfs)	Peak Recharge Rate (cfs)	Emergency Spillway Crest Elevation (ft-msl)	Maximum Water-Surface Elevation Attained (ft-msl) <sup>1</sup>	Drawdown Time (days)
Comal River Site 4	N/A	N/A	N/A	N/A	N/A
Salado Creek Site 11	59.3	148.0	877.8	877.7	9.2
Salado Creek Site 13A	75.1	105.4	877.0	878.7	9.7
Notes:					
1. If higher than the elevation of the emergency spillway, the routing was performed assuming that the emergency spillway is blocked.					



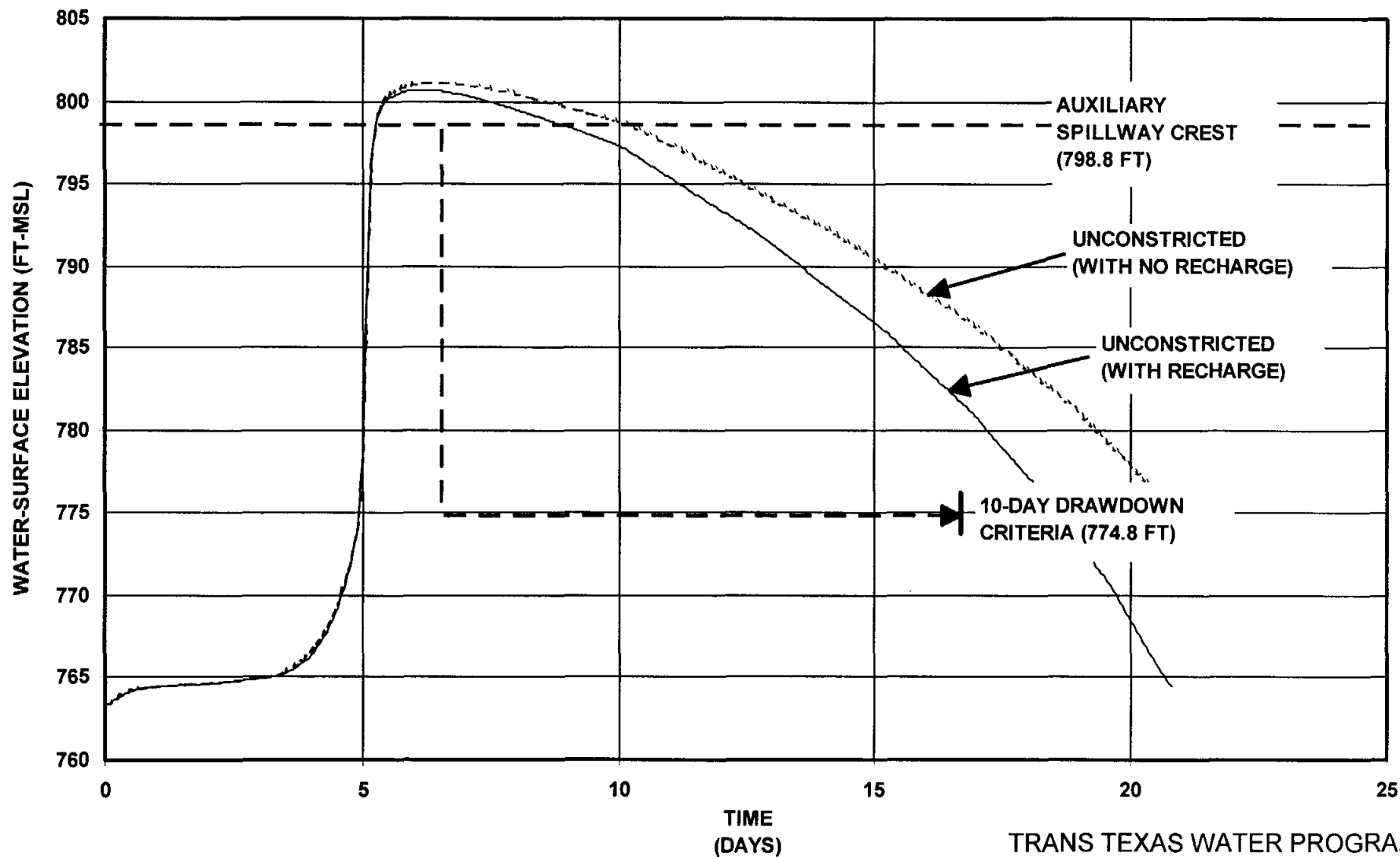

TRANS TEXAS WATER PROGRAM /  
WEST CENTRAL STUDY AREA

**COMAL SITE 4  
FLOOD POOL HYDROGRAPH**

MODIFICATION OF PRINCIPAL SPILLWAYS AT  
EXISTING FLOOD CONTROL PROJECTS FOR  
RECHARGE ENHANCEMENT



HDR Engineering, Inc.

FIGURE 3 - 5

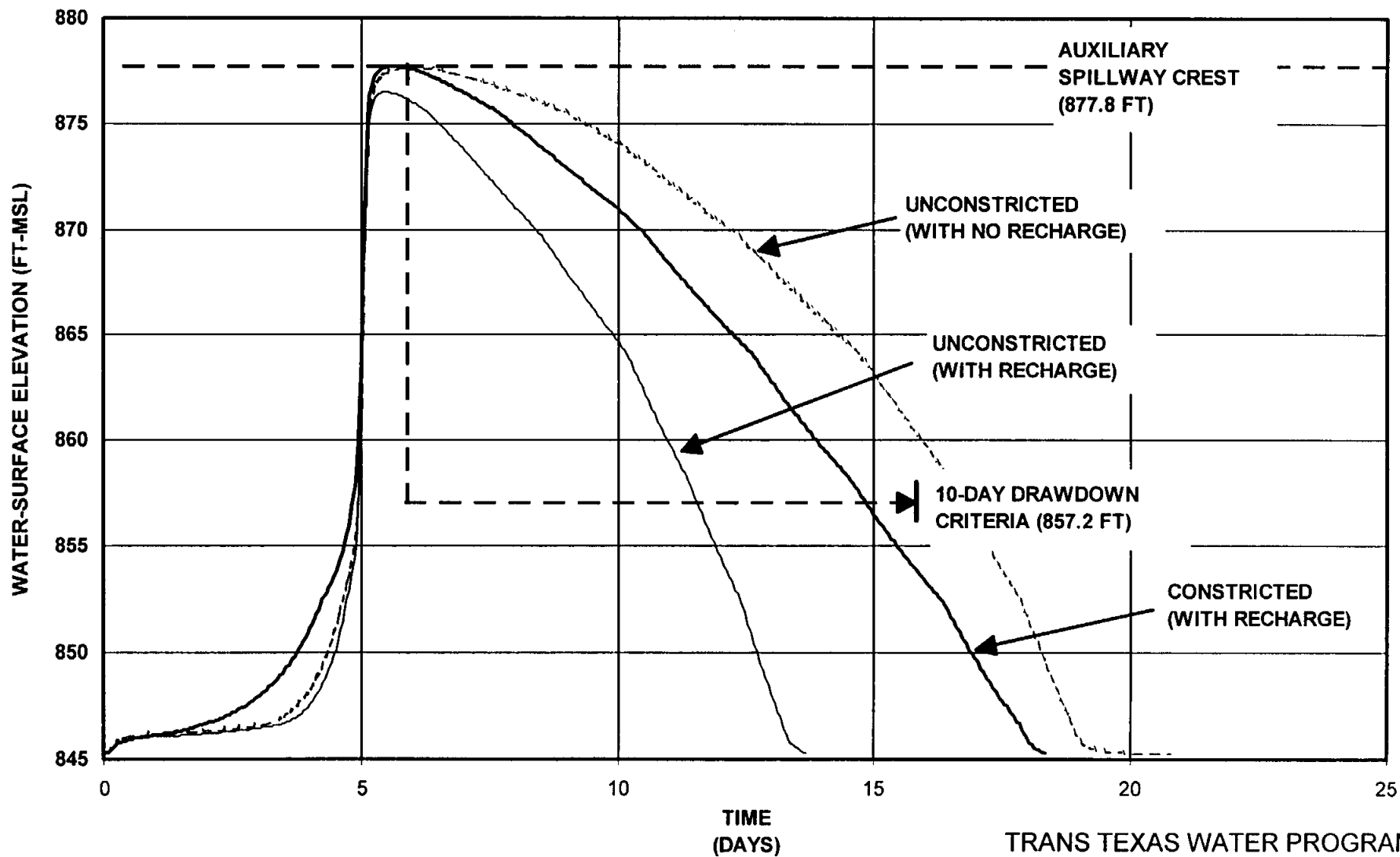

TRANS TEXAS WATER PROGRAM /  
WEST CENTRAL STUDY AREA

**SALADO SITE 11  
FLOOD POOL HYDROGRAPH**



HDR Engineering, Inc.

FIGURE 3 - 6

MODIFICATION OF PRINCIPAL SPILLWAYS AT  
EXISTING FLOOD CONTROL PROJECTS FOR  
RECHARGE ENHANCEMENT

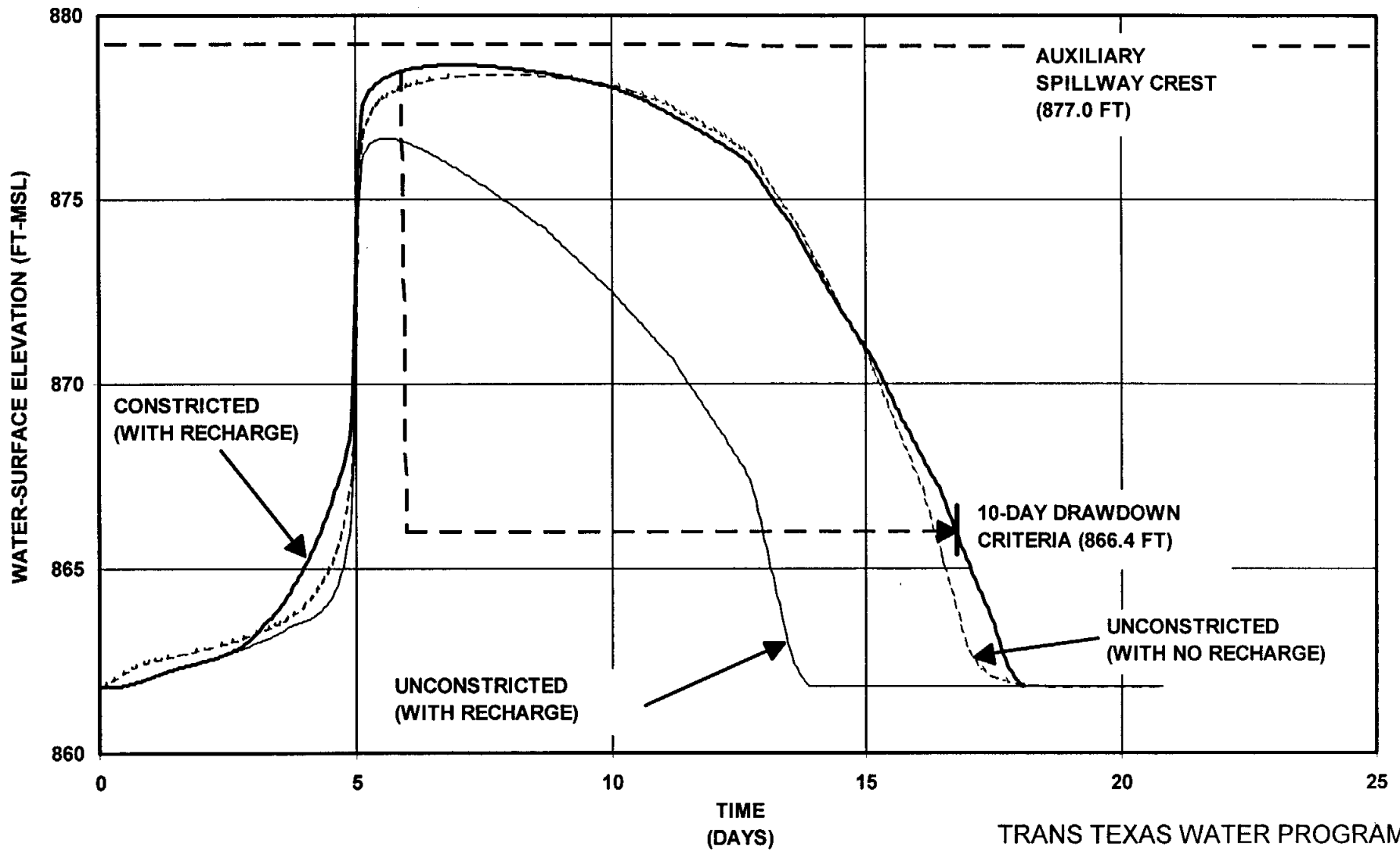

TRANS TEXAS WATER PROGRAM /  
WEST CENTRAL STUDY AREA

**SALADO SITE 13A  
FLOOD POOL HYDROGRAPH**

MODIFICATION OF PRINCIPAL SPILLWAYS AT  
EXISTING FLOOD CONTROL PROJECTS FOR  
RECHARGE ENHANCEMENT



HDR Engineering, Inc.

FIGURE 3 - 7

#### 4.0 RECHARGE ENHANCEMENT POTENTIAL

Modification of the principal spillways by reducing the discharge capacity will enhance recharge to the Edwards Aquifer by reducing the amount of outflow from the reservoir and allowing it to recharge within the upstream reservoir area. The amount of recharge enhancement that may be obtained by modifying the spillway can be demonstrated by examining a series of hypothetical storm events and calculating the amount of floodwater that would recharge into the aquifer with and without the spillway modification. Table 4-1 summarizes a series of hypothetical, 24-hour storm (SCS Type II) events for Salado Creek Site 11, ranging from storm depths of 2 inches to almost 10 inches. For storm events with rainfall depths less than 5 inches, the volume of runoff recharged under present conditions would range from 20 percent to 30 percent of the total volume of runoff. Reducing the principal spillway discharge capacity by about 60 percent results in the volume of recharge increasing to 30 percent to 50 percent of the total runoff volume. For larger storm events with storm depths exceeding five inches, the volume of recharge under present conditions would range from 30 percent to 40 percent of the total runoff volume. Reducing the principal spillway discharge capacity results in the volume of recharge increasing to 50 percent to 60 percent of the total runoff volume.

24-hour Storm Rainfall (inches)	Runoff Volume <sup>2</sup> (inches) (ac-ft)		Existing Conditions		With Principal Spillway Modification		Recharge Enhancement <sup>3</sup>	
			Principal Spillway Discharge (ac-ft)	Edwards Aquifer Recharge (ac-ft)	Principal Spillway Discharge (ac-ft)	Edwards Aquifer Recharge (ac-ft)	Recharge Increase (ac-ft)	Percent Recharge Increase (%)
2.0	0.6	211	170	41	141	70	29	73%
3.0	1.3	459	356	102	280	179	77	75%
4.0	2.1	742	548	194	414	328	134	69%
5.0	3.0	1,044	734	310	537	507	197	64%
6.0	3.9	1,358	915	443	653	706	263	59%
7.0	4.8	1,681	1,092	589	762	919	330	56%
8.0	5.7	2,009	1,263	745	867	1,142	397	53%
9.0	6.7	2,340	1,431	909	967	1,374	465	51%
9.8 <sup>1</sup>	7.5	2,609	1,563	1,046	1,045	1,563	518	50%

Notes:

1. Storm total rainfall for the 100-year return period storm event.
2. Runoff volume based on computation using the SCS Runoff Curve Number Method with a runoff curve number of 81.
3. Recharge enhancement is the difference between the Edwards Aquifer recharge with principal spillway modification and existing conditions.

While the single storm event analysis demonstrates the potential for recharge enhancement by reducing the discharge capacity of the principal spillway, assessment of the long-term benefits requires the analysis to be expanded to cover a time period of many years. Assessment of the long-term recharge enhancement benefits of NRCS flood control structures is a feature incorporated into the Guadalupe-San Antonio River Basin Model (GSA Model).<sup>1</sup> The GSA Model utilizes a methodology for estimating recharge enhancement by NRCS flood control structures on a monthly time step. Historical recharge for the 1934-89 period was developed for watersheds upstream of and on the Edwards Aquifer recharge zone that included a program of NRCS flood control structures. In order to assess the recharge characteristics of the NRCS structures, it was presumed that historical recharge ( $R$ ) is comprised of natural recharge ( $R_N$ ) and additional components associated with the normal pool ( $R_{NP}$ ) and active pool ( $R_{AP}$ ) storage of the NRCS structures as defined in the following equations:

$$R = R_N + R_{NP} + R_{AP} \quad [4-1]$$

$$R_{NP} = c_{NP} \left( \frac{A_c}{A} \right) (QI - R_N) \leq c_{NP} (NP) \quad [4-2]$$

$$R_{AP} = c_{AP} \left[ \left( \frac{A_c}{A} \right) (QI - R_N) - R_{NP} \right] \leq c_{AP} (AP) \quad [4-3]$$

where:

- $R$  = Historical Recharge;
- $R_N$  = Natural Recharge;
- $R_{NP}$  = SCS/FRS Normal Pool Recharge;
- $R_{AP}$  = SCS/FRS Active Pool Recharge;
- $QI$  = Potential Runoff;
- $A_c$  = Watershed Area Controlled;
- $A$  = Total Watershed Area;
- $c_{NP}$  = Normal Pool Recharge Coefficient;
- $c_{AP}$  = Active Pool Recharge Coefficient;
- $NP$  = Aggregate Normal Pool Storage; and
- $AP$  = Aggregate Active Pool Storage.

The methodology used to estimate the recharge coefficients included the development of monthly natural recharge estimates obtained from a linear regression between the natural and potential runoff based on available data prior to construction of the NRCS flood control

---

<sup>1</sup> HDR Engineering, Inc., "Guadalupe-San Antonio River Basin Recharge Enhancement Study," Edwards Aquifer

structures. The normal pool recharge coefficient was assumed to equal 1.0 which implies that 100 percent of the water impounded within the normal pools (below the principal spillway crest elevation) will contribute to recharge, neglecting evaporation. Historical monthly recharge was then computed based on the equations using various assumed values for the active pool recharge coefficient. An assumed active pool recharge coefficient of 0.63 resulted in the least error in estimating historical recharge in the Salado Creek watershed. This result implies that, over a long-term period, approximately 63 percent of the runoff temporarily impounded by the NRCS flood control structures contributes to recharge, neglecting evaporation. This same procedure was applied in the Comal River watershed. The active pool recharge coefficient in the Comal River watershed was found to be 0.70, which is slightly higher than the Salado Creek watershed and likely a result of recharge being included in the design of Comal River structures.

For the two selected Salado Creek flood control structures, Site 11 and Site 13A, the design principal spillway discharge was reduced 57 percent (135 cfs to 58 cfs) and 55 percent (165 cfs to 74 cfs), respectively. For purposes of estimating the long-term recharge enhancement benefits of reducing the spillway capacity by this amount, the corresponding percentage of active pool storage was simulated in the GSA Model as normal pool storage. For example, the normal pool storage for Site 11 is 84 acre-feet and the active pool storage is 2,512 acre-feet. Design storm routings indicate that the principal spillway discharge capacity could be reduced by 57 percent and meet the 10-day drawdown design criteria. Therefore, for simulating the recharge enhancement benefits for Site 11 in the GSA Model, the normal pool storage was increased by 1,432 acre-feet, the corresponding percentage of active pool storage (57% of 2,512 acre-feet) and the active pool storage was reduced by the same amount. For Site 13A, the normal pool storage of 128 acre-feet and active pool storage of 1,313 acre-feet were increased and reduced by 722 acre-feet (55% of 1,313 acre-feet), respectively.

Results of the GSA Model simulation indicate that an average of 373 acre-feet per year of additional recharge could potentially be produced by reducing the principal spillway discharge capacity, without impairing the flood-control function of the structures. During the 10-year drought period of 1947 to 1956, additional recharge would be insignificant because the natural

recharge rate and existing flood control structures maximize recharge. Table 4-2 presents a recharge summary for Salado Creek Site 11 and Site 13A.

<b>Table 4-2 Summary of Recharge Enhancement for Salado Creek Site 11 and Site 13A</b>				
<b>Flood Control Structure</b>	<b>Natural Recharge<sup>1</sup> (acft/yr)</b>	<b>Existing Recharge Enhancement<sup>2</sup> (acft/yr)</b>	<b>Additional Recharge with Modification of Principal Spillway (acft/yr)</b>	<b>Total Recharge (acft/yr)</b>
<b>Site 11</b>				
1934-1989 (average)	2,615	429	249	3,293
1947-1956 (average)	1,054	214	0	1,268
<b>Site 13A</b>				
1934-1989 (average)	1,307	513 <sup>3</sup>	124	1,944
1947-1956 (average)	527	82 <sup>3</sup>	0	609
Notes:				
1. Natural recharge includes recharge within contributing watershed area.				
2. Natural and enhanced recharge based on simulation of GSA Model.				
3. Existing recharge enhancement includes capture and recharge of floodwater discharge from Site 12 located upstream.				

## 5.0 IMPLEMENTATION

Modification of the principal spillways for enhancement of recharge at the existing NRCS flood control structures involves reduction of the spillway discharge capacity. There are several methods for reducing the principal spillway discharge capacity including the recommended installation of an orifice plate in the intake tower to reduce flow into the outlet conduit. Requirements for implementation of the modification should include flexibility to adjust the discharge capacity based on future observations of performance. The conceptual plan includes a steel orifice plate installed over the entrance to the outlet conduit inside of the drop inlet structure. The estimated cost for the conceptual plan as shown in Table 5-1 is approximately \$13,000, which includes installation of the orifice plate, construction contingencies, and engineering costs.

<b>Item</b>	<b>Quantity</b>	<b>Units</b>	<b>Unit Cost</b>	<b>Total Cost</b>
Plate Fabrication and Installation	1	Lump Sum	\$10,000	\$10,000
Contingencies (15%)				\$1,500
Engineering (15%)				\$1,500
<b>Total</b>				<b>\$13,000</b>

Operation and maintenance of the principal spillway modification is expected to be minimal. Therefore, the annual cost associated with implementation of the modification is essentially debt service, which would result in an annual cost of \$1,218 per structure assuming an interest rate of 8.0 percent and a financing period of 25 years. The unit cost of recharge for average conditions (1934-1989) would be about \$4.89 per acre-feet for Site 11 and \$9.82 for Site 13A. Although the volume of recharge associated with each individual project is small, the low cost and ease of implementation results in an economical project.



**Table 5-2  
Recharge Enhancement Cost Summary**

<b>Flood Control Structure</b>	<b>Annual Cost</b>	<b>1934-89 Average Recharge (acft/yr)</b>	<b>1947-56 Drought Recharge (acft/yr)</b>	<b>Average Unit Cost of Recharge (\$/acft)</b>	<b>Drought Unit Cost of Recharge (\$/acft)</b>
Salado Creek Site 11	\$1,218	249	0	\$4.89	N/A
Salado Creek Site 13A	\$1,218	124	0	\$9.82	N/A
<b>Total</b>	<b>\$2,436</b>	<b>373</b>	<b>0</b>	<b>\$6.53</b>	<b>N/A</b>

## 6.0 SUMMARY

Modification of the principal spillways at existing flood control projects in the Guadalupe-San Antonio River Basin is a relatively low cost method for enhancement of recharge. The potential for recharge enhancement appears to be the greatest in the Salado Creek watershed as most of the principal spillways for these structures appear to have been sized without considering the effects of recharge within the reservoir pool. Modification of the principal spillways at existing flood control projects in the Comal River and Upper San Marcos River watersheds is not considered to be feasible due to the rate of recharge in the reservoir pool being included in sizing the principal spillway for those structures. Modification of the principal spillways at the two York Creek flood control projects on the Edwards Aquifer recharge zone is not recommended due to the lower design standard for these structures (Class A structures) and concerns about the overall hydraulic capacity to meet the TNRCC Hydrologic Criteria for Dams.

The results of this study indicate that an average of approximately 373 acre-feet of additional recharge could potentially be achieved by reducing the hydraulic capacity of the principal spillways at two structures (Site 11 and Site 13A) in the Salado Creek watershed. Including the rate of recharge in the reservoir pool area allows for the principal spillway discharge capacity to be reduced and still meet the NRCS 10-day drawdown design criteria for the structure. Overall, the cost for implementation is relatively low, resulting in average annual unit costs for recharge enhancement ranging from \$4.89 to \$9.82 per acre-foot. At these minimal unit costs, resolution of institutional and permitting issues associated with implementation is of primary importance so that the benefits of increased aquifer pumpage and/or springflow may be fully realized.

A monitoring system consisting of stage recorders is recommended for installation at the structures and on the stream channel flowing into the reservoir. The monitoring system should be capable of measuring reservoir stage and inflow for a series of storm events to quantify the actual recharge rates within the reservoir pool. Actual recharge rates in the reservoir pool are expected to be higher than the estimates developed in this study, which may result in further reduction of the principal spillway discharge capacity and a greater potential for recharge enhancement. Implementation of a data collection system at other potential sites such as

Salado Creek Sites 4, 5, 6, and 10 is also recommended to provide data for future assessment of the potential for modification of the principal spillways at those sites.

**Report 4**

**Edwards Aquifer  
Recharge Update**

**TRANS-TEXAS WATER PROGRAM  
WEST CENTRAL STUDY AREA**

**PHASE 2**

**MODIFICATION OF PRINCIPAL SPILLWAYS AT  
EXISTING FLOOD CONTROL PROJECTS FOR  
RECHARGE ENHANCEMENT**

**San Antonio River Authority  
San Antonio Water System  
Edwards Aquifer Authority  
Guadalupe-Blanco River Authority  
Lower Colorado River Authority  
Bexar Metropolitan Water District  
Nueces River Authority  
Canyon Lake Water Supply Corporation  
Bexar-Medina-Atascosa Counties WCID No. 1  
Texas Natural Resource Conservation Commission  
Texas Parks and Wildlife Department  
Texas Water Development Board**

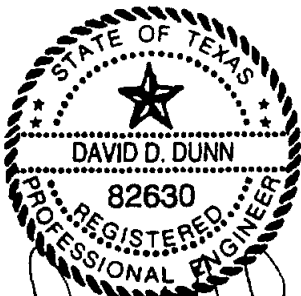

*David D. Dunn*  
3/25/98

**HDR**

HDR Engineering, Inc.

March 1998

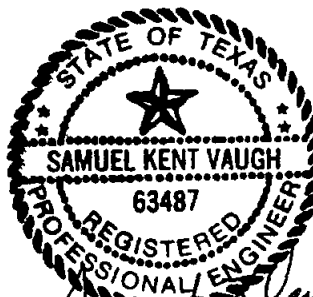

*Samuel Kent Vaughn*  
3/25/98

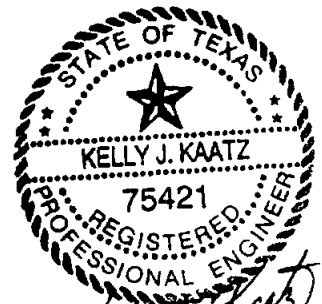

*Kelly J. Kaatz*  
3/25/98

**TRANS-TEXAS WATER PROGRAM  
WEST CENTRAL STUDY AREA**

**EDWARDS AQUIFER RECHARGE UPDATE**

**TABLE OF CONTENTS**

<b>Section</b>	<b>Page</b>
<b>1.0 INTRODUCTION.....</b>	<b>1-1</b>
<b>2.0 DATA COLLECTION AND REFINEMENT .....</b>	<b>2-1</b>
<b>3.0 RECHARGE SUMMARY AND COMPARISONS .....</b>	<b>3-1</b>
<b>3.1 Nueces River Basin .....</b>	<b>3-1</b>
<b>3.2 Guadalupe - San Antonio River Basin .....</b>	<b>3-3</b>
<b>3.3 General Comparisons .....</b>	<b>3-5</b>
<b>4.0 RECOMMENDATIONS.....</b>	<b>4-1</b>
 <b>APPENDICES</b>	
<b>A HISTORICAL EDWARDS AQUIFER RECHARGE ESTIMATES.....</b>	<b>A-1</b>

## LIST OF FIGURES

<b>Figure No.</b>		<b>Page</b>
1.0-1	Nueces River Basin Edwards Aquifer Recharge Basins.....	1-3
1.0-2	GSA River Basin Edwards Aquifer Recharge Basins .....	1-4
2.0-1	Reported Water Use Comparisons.....	2-2
3.1-1	Annual Edwards Aquifer Recharge Comparisons Nueces River Basin.....	3-2
3.2-1	Annual Edwards Aquifer Recharge Comparisons GSA River Basin .....	3-4
3.3-1	Geographical Comparison of Edwards Aquifer Recharge by Recharge Basin.....	3-7
3.3-2	Long Term Edwards Aquifer Recharge Comparisons.....	3-8
3.3-3	Geographical Comparison of Edwards Aquifer Recharge by River Basin.....	3-10

## LIST OF TABLES

<b>Table No.</b>		<b>Page</b>
3.3-1	Summary of Average Historical Edwards Aquifer Recharge by Basin (1934-96).....	3-6

## 1.0 INTRODUCTION AND BACKGROUND

The 1990-96 historical period was one of extremes with respect to fluctuations in pumpage, water levels, and springflows associated with the Edwards Aquifer. Coming out of a drought in the late 1980's which resulted in record high annual pumpage (543,000 acft) in 1989, the Edwards Aquifer rose to a record high level of about 703 ft-msl recorded at the Bexar County Monitoring Well (J-17) in June, 1992 when pumpage fell to the lowest annual rate (327,000 acft) since 1973. Then, another drought cycle ensued resulting in significantly reduced springflows and severe water use restrictions during the summer of 1996. In addition to improved estimates of pumpage, the extremes experienced by the aquifer make the first half of the 1990's an excellent period for potential use in calibration of Edwards Aquifer models such as the GWSIM4 model developed by the Texas Water Development Board (TWDB).<sup>1</sup>

The TWDB staff is, in fact, engaged in recalibration and enhancement of the GWSIM4 model which has been applied extensively in the Trans-Texas Water Program, Edwards Aquifer litigation, and numerous technical and planning studies. This recalibration effort has been prompted by the availability of improved geological mapping in Hays, Comal, and Bexar Counties, installation of a precipitation (and streamflow) gaging network in the Edwards outcrop area, completion of aquifer divide studies, and ongoing water balance studies for Medina Lake and the Guadalupe River. In addition, estimates of historical Edwards Aquifer recharge have been developed by HDR Engineering, Inc. (HDR) in the course of studies sponsored by the Edwards Underground Water District<sup>2</sup> and Nueces River Authority.<sup>3</sup> Based on the 1934-89 historical period, HDR estimates differ significantly from those published by the U.S. Geological Survey<sup>4</sup> (USGS) in terms of both geographical and temporal distribution.

As the TWDB has expressed an interest in using the most recent historical data available in the recalibration effort and regional sponsors have expressed their concurrence, HDR has

---

<sup>1</sup> TWDB, "Ground-water Resources and Model Applications for the Edwards (Balcones Fault Zone) Aquifer in the San Antonio Region," Report 239, October, 1979.

<sup>2</sup> HDR, "Guadalupe - San Antonio River Basin Recharge Enhancement Study," Vol. 2, Edwards Underground Water District, September, 1993.

<sup>3</sup> HDR, "Nueces River Basin Regional Water Supply Planning Study, Phase I," Vol. 2, Nueces River Authority, et al., May, 1991.

<sup>4</sup> USGS, "Recharge to and Discharge from the Edwards Aquifer in the San Antonio Area, Texas, 1996," <http://txwww.cr.usgs.gov/reports/info/97/recharge1/index.html>, April, 1997.



updated its recharge estimates to include the 1990-96 historical period and will provide them to the TWDB for consideration as an alternative to published USGS estimates. Estimates of Edwards Aquifer recharge have been developed for four recharge basins in the Nueces River Basin (Figure 1.0-1) and five recharge basins in the Guadalupe - San Antonio River Basin (Figure 1.0-2) for the 1990-96 historical period. The following sections of this report detail the data collection and refinement efforts prerequisite to recharge calculation, summarize the resulting estimates of Edwards Aquifer recharge in both historical and geographical contexts, and provide comparisons to published USGS estimates. Recommendations regarding opportunities for improvement of recharge estimates are included in Section 4.

**LEGEND**

- RECHARGE AREA
- USGS STREAMGAGE
- RECHARGE BASIN BOUNDARY
- STREAMGAGE BASIN BOUNDARY
  
- RECHARGE BASINS
- ① NUECES - WEST NUECES
- ② FRIO - DRY FRIO
- ③ SABINAL
- ④ AREA BETWEEN SABINAL AND MEDINA RIVER
  
- UNGAGED AREAS
- A LEONA RIVER
- B HACKBERRY AND BLANCO CREEKS
- C LITTLE BLANCO AND NOLTON CREEKS
- D RANCHERO CREEK
- E PARKERS AND LIVE OAK CREEKS
- F AREA BETWEEN HONDO CREEK AND MEDINA RIVER
- F-1 ABOVE RECHARGE ZONE
- F-2 RECHARGE ZONE - VERDE CREEK
- F-3 RECHARGE ZONE - OTHER

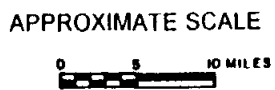
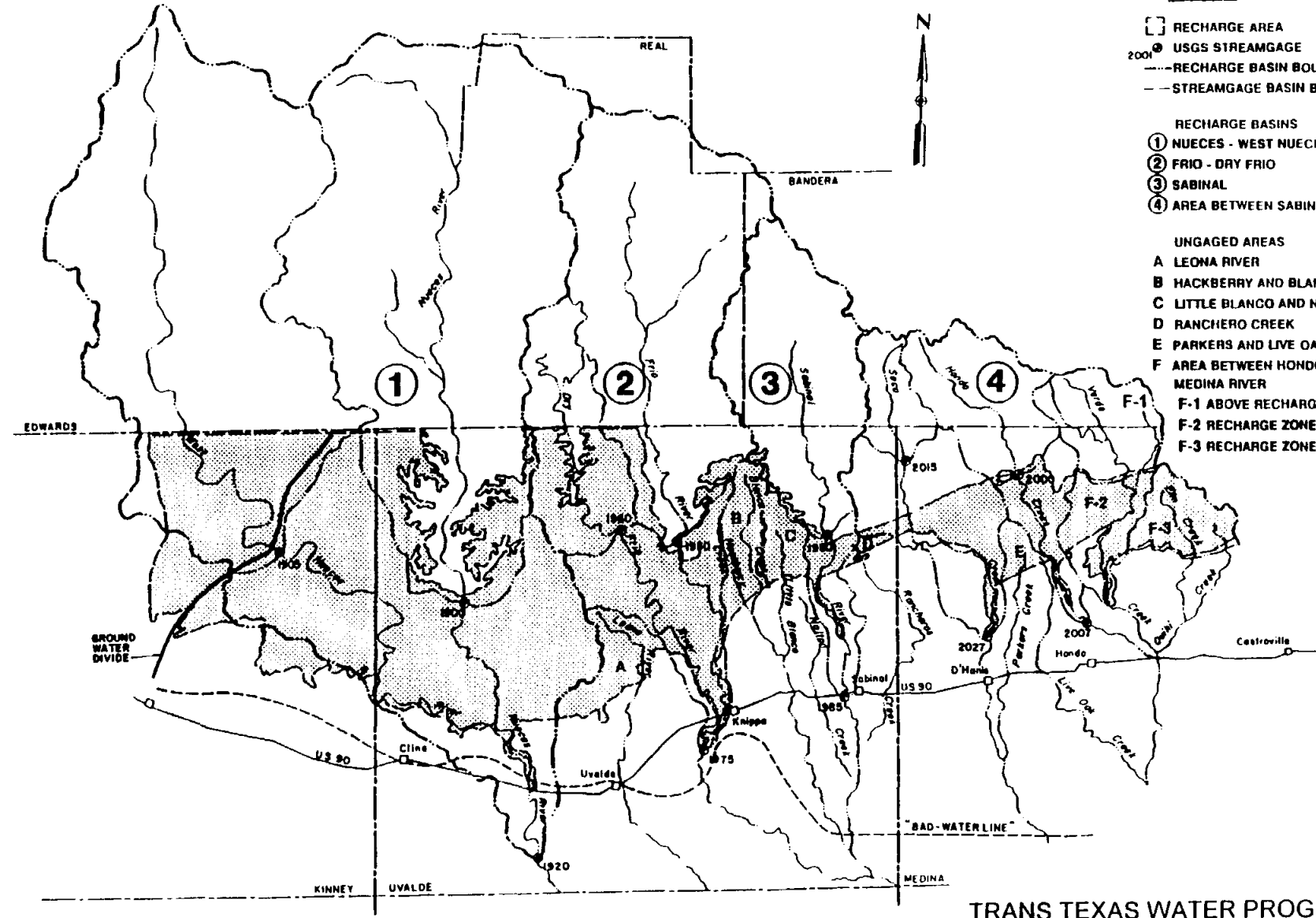

EDWARDS AQUIFER  
RECHARGE UPDATE



HDR Engineering, Inc.

TRANS TEXAS WATER PROGRAM /  
WEST CENTRAL STUDY AREA

**NUECES RIVER BASIN  
EDWARDS AQUIFER  
RECHARGE BASINS**

FIGURE 1.0-1

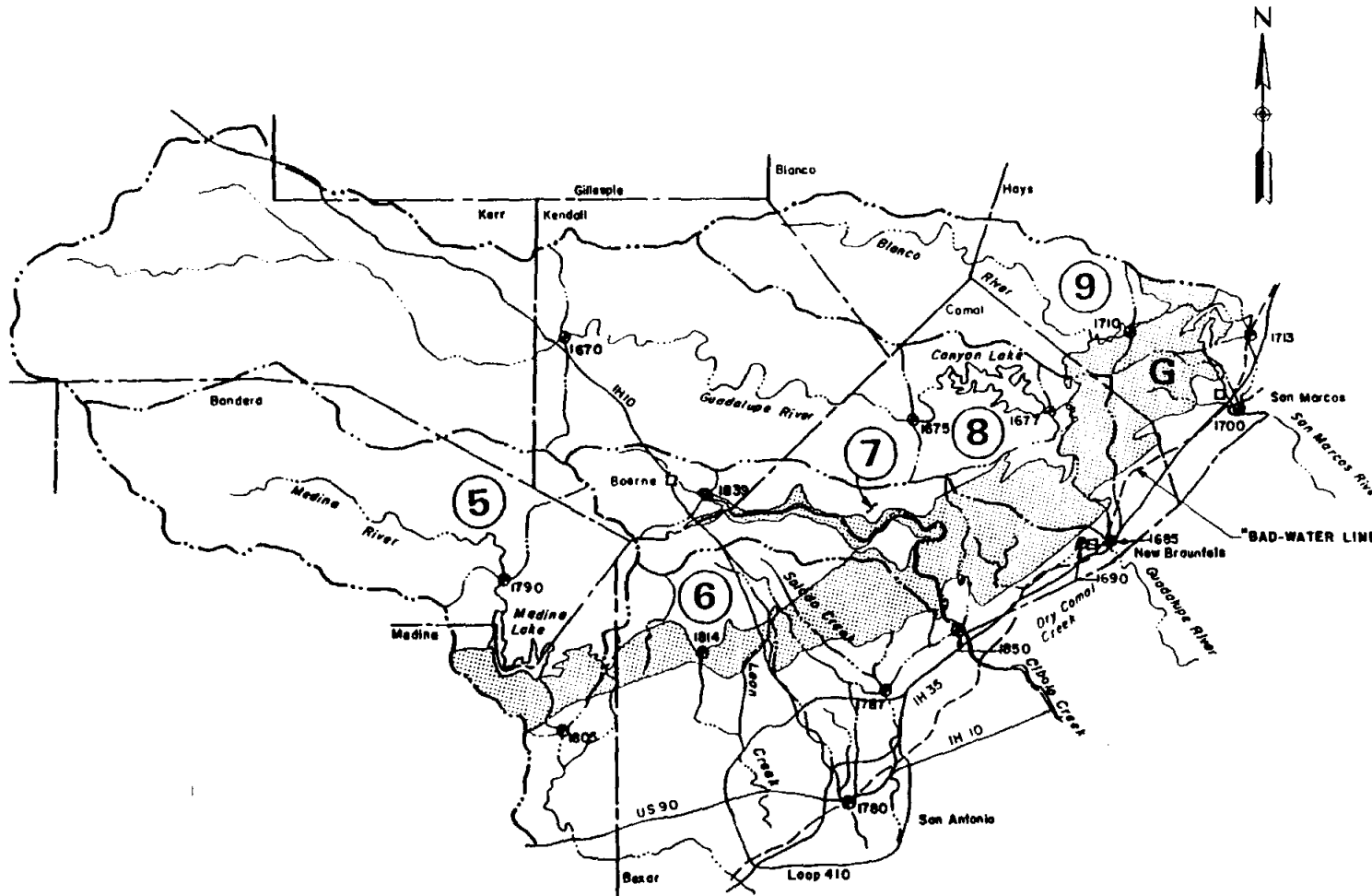

**LEGEND**

- RECHARGE AREA
- 1710    USGS STREAMGAGE
- RECHARGE BASIN BOUNDARY
- STREAMGAGE BASIN BOUNDARY

**RECHARGE BASINS**

- 5 MEDINA RIVER
- 6 AREA BETWEEN MEDINA AND CIBOLO
- 7 CIBOLO AND DRY COMAL
- 8 GUADALUPE
- 9 BLANCO

**UNGAGED AREAS**

- G SINK, PURGATORY, YORK AND ALLIGATOR CREEKS

APPROXIMATE SCALE

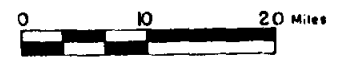

TRANS TEXAS WATER PROGRAM /  
WEST CENTRAL STUDY AREA

**GSA RIVER BASIN  
EDWARDS AQUIFER  
RECHARGE BASINS**

FIGURE 1.0-2

EDWARDS AQUIFER  
RECHARGE UPDATE



HDR Engineering, Inc.

## 2.0 DATA COLLECTION AND REFINEMENT

The first step in the process of Edwards Aquifer recharge calculation was the collection of pertinent monthly hydrologic data sets including precipitation, streamflow, reservoir contents, surface water use, treated effluent volumes, and net evaporation for the 1990-96 historical period. Pertinent hydrologic data sets collected and primary sources are summarized as follows:

- Precipitation — National Weather Service, USGS, TWDB
- Streamflow — USGS
- Reservoir Contents — USGS, Bexar-Medina-Atascosa Counties WCID#1 (BMA), Blackwell, Carter & Associates, Inc. (BCA)
- Surface Water Use — Texas Natural Resource Conservation Commission (TNRCC, Office of the Water Master), USGS, BMA, BCA
- Treated Effluent Volumes — TNRCC
- Net Evaporation — BCA

Supplementary hydrologic data collected also includes monthly estimates of recharge for existing enhancement projects provided by the Edwards Aquifer Authority (EAA) and annual historical recharge by basin available from the USGS.

Once all pertinent information was in hand and prior to initiating recharge calculations, data sets from various sources were assembled and refined through review for consistency, estimation of unavailable data, areal precipitation computation, streamflow naturalization, and potential runoff calculation. Only one concern was noted regarding consistency of data for the 1990-96 period as compared with earlier years. This concern is associated with reported surface water use data provided by the TNRCC Water Master and its consistency with earlier data which was obtained from the TNRCC (prior to full implementation of the Water Master program). Figure 2.0-1 shows reported surface water use for four selected stream segments upstream of the Edwards Aquifer recharge zone for the 1980-96 period. While the apparent inconsistencies shown in Figure 2.0-1 may appear rather alarming, the potential effect on long-term average recharge estimates is minimal, so the surface water use data provided by the TNRCC Water Master was used directly. Areal precipitation computation, streamflow naturalization, and potential runoff calculation were all accomplished using techniques described in referenced studies.<sup>1,2</sup>

---

<sup>1</sup> HDR, Op. Cit., September, 1993.

<sup>2</sup> HDR, Op. Cit., May, 1991.

**BLANCO RIVER ABOVE WIMBERLEY**

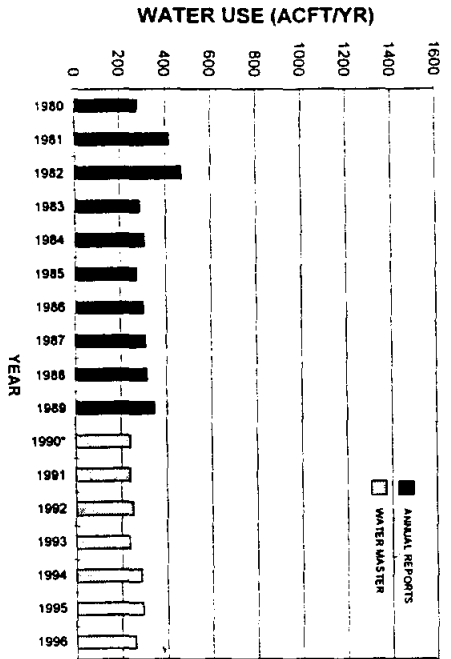

**NUECES RIVER ABOVE LAGUNA**

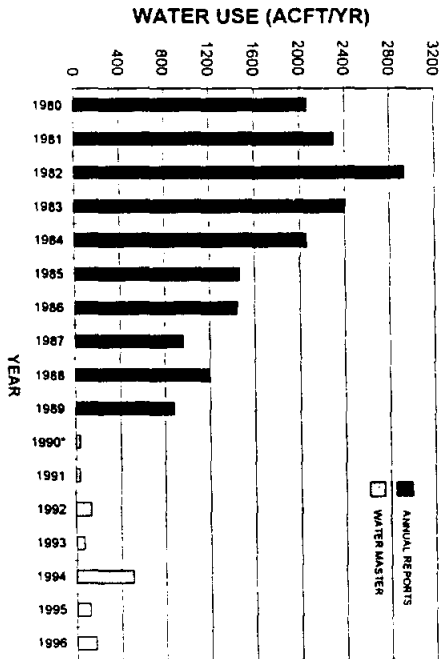

**MEDINA RIVER ABOVE PIPE CREEK**

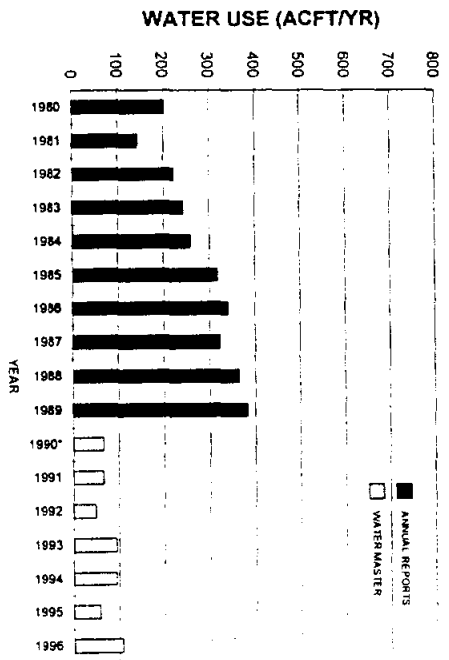

**FRIO RIVER ABOVE CONCAN**

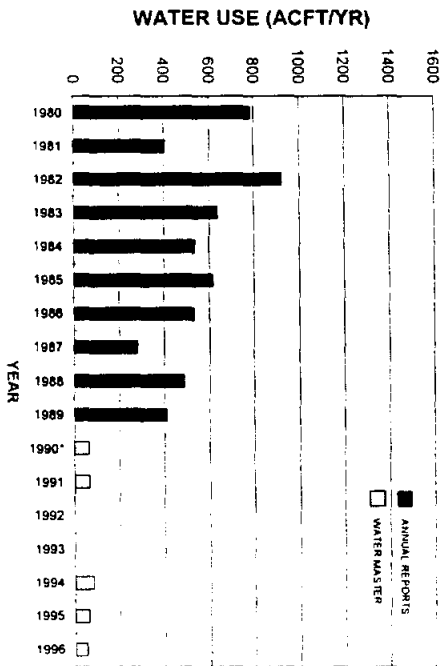

\* No records of use available from TNRCC Water Master's office.  
 Water use assumed equal to that reported in 1991.

EDWARDS AQUIFER  
 RECHARGE UPDATE



HDR Engineering, Inc.

TRANS TEXAS WATER PROGRAM /  
 WEST CENTRAL STUDY AREA  
**REPORTED WATER USE  
 COMPARISONS**

FIGURE 2.0-1

### 3.0 RECHARGE SUMMARY AND COMPARISONS

Methodologies previously developed and applied by HDR in the computation of Edwards Aquifer recharge on a monthly timestep are described at length in studies prepared under the sponsorship of the Edwards Underground Water District<sup>1</sup> and the Nueces River Authority.<sup>2</sup> For consistency with these referenced studies, recharge estimates for the 1990-96 period have been computed using methodologies and assumptions identical to those previously applied. Resulting recharge estimates are summarized by major river basin in the following subsections and compared to those estimates prepared by the USGS. A comprehensive summary of historical Edwards Aquifer recharge estimates by river and recharge basin for the full 1934-96 historical period is included as Appendix A.

#### 3.1 Nueces River Basin

The Nueces River Basin has been subdivided into four recharge basins identified in Figure 1.0-1 as the Nueces / West Nueces, Frio / Dry Frio, Sabinal, and the Area Between Sabinal and Medina Basin (which includes Seco, Hondo, and Verde Creek as well as several smaller tributary streams). In addition to naturally occurring recharge in the Nueces River Basin, the EAA (formerly EUWD) has constructed projects located on Seco, Parkers, and Verde Creek which serve to enhance recharge. Recharge associated with these projects was provided by the EAA for inclusion in the recharge basin summaries presented herein.

Figure 3.1-1 summarizes both HDR and USGS estimates of Edwards Aquifer recharge for each recharge basin within the Nueces River Basin for the 1990-96 historical period. Based on the full 1934-96 historical period, record high annual recharge volumes (432,412 acft) for the Sabinal River and the Seco, Hondo, and Verde Creek basins occurred in 1992 while a record low annual recharge volume of only 1,894 acft was computed for the Hondo Creek basin in 1996. It is readily apparent in Figure 3.1-1 that USGS recharge estimates in the wettest years are sometimes more than double those computed by HDR. There are several fundamental differences between certain recharge calculation procedures employed by the USGS and HDR,

---

<sup>1</sup> HDR, Op. Cit., September, 1993.

<sup>2</sup> HDR, Op. Cit., May, 1991.

NUECES/WEST NUECES BASIN

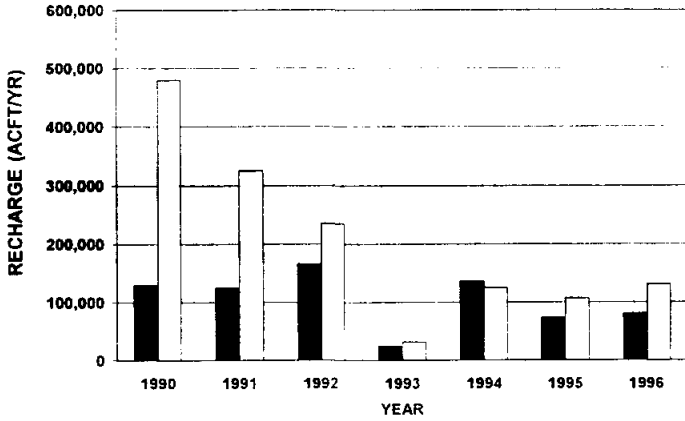

FRIO/DRY FRIO BASIN

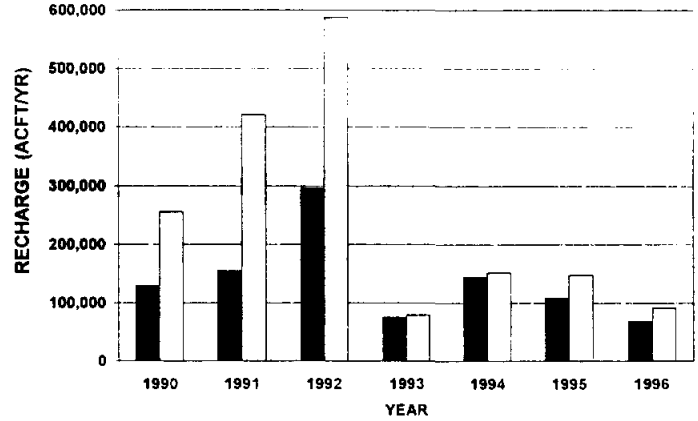

SABINAL BASIN

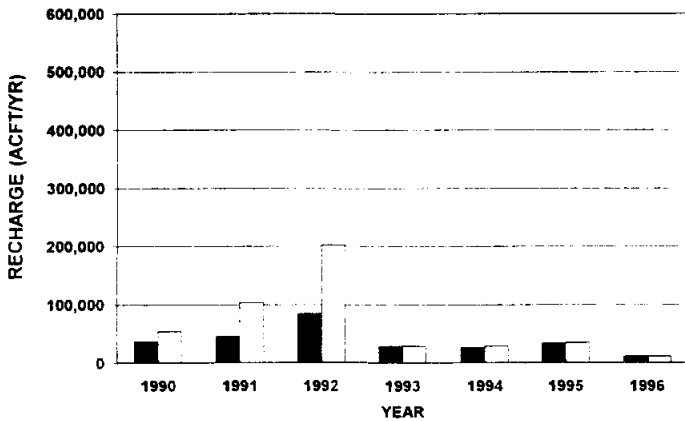

AREA BETWEEN SABINAL AND MEDINA BASIN

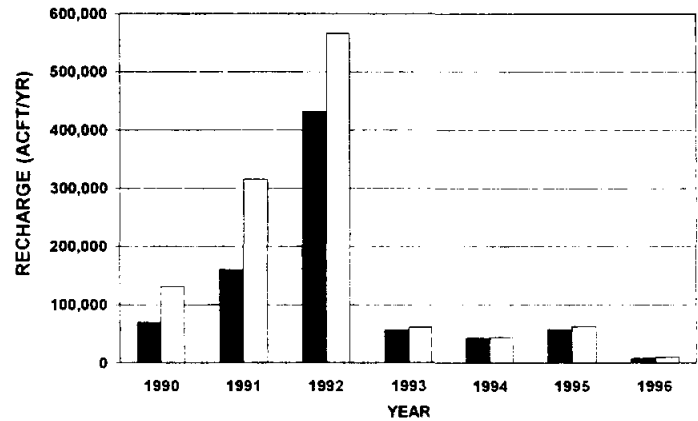

**LEGEND**

- HDR
- USGS



HDR Engineering, Inc.

TRANS TEXAS WATER PROGRAM /  
WEST CENTRAL STUDY AREA

**ANNUAL EDWARDS AQUIFER  
RECHARGE COMPARISONS  
NUECES RIVER BASIN**

such as areal precipitation calculation, potential runoff estimation, and accounting for reported water rights diversions. The extreme difference in wet year estimates, however, is believed to be associated with the USGS application of "base flow curves" relating base flow upstream of the Edwards Aquifer outcrop to storage in the Edwards Plateau Aquifer contributing to base flow.<sup>3</sup>

### **3.2 Guadalupe - San Antonio River Basin**

The Guadalupe - San Antonio River Basin has been subdivided into five recharge basins identified in Figure 1.0-2 as the Medina River, Area Between Medina and Cibolo (which includes San Geronimo, Helotes, Leon, and Salado Creek as well as several smaller tributary streams), Cibolo and Dry Comal, Guadalupe, and Blanco. In addition to naturally occurring recharge in the Guadalupe - San Antonio River Basin, the EAA has constructed one recharge project located on San Geronimo Creek and the Natural Resources Conservation Service (formerly Soil Conservation Service) has constructed numerous Flood Retardation Structures (FRS) in the Salado, Dry Comal, and Upper San Marcos basins which serve to enhance recharge. Recharge associated with the San Geronimo project was provided by the EAA for inclusion in the recharge basin summaries presented herein. Estimates of historical recharge enhancement associated with the FRS were computed by HDR using methodologies summarized in a previous study.<sup>4</sup>

Figure 3.2-1 summarizes both HDR and USGS estimates of Edwards Aquifer recharge for each recharge basin within the Guadalupe - San Antonio River Basin for the 1990-96 historical period. Based on the full 1934-96 historical period, record high annual recharge amounts for the Upper San Marcos River, Salado Creek, and combined Cibolo and Dry Comal Creek basins occurred in 1992. With the exceptions of the Medina / Diversion Lake System and the Guadalupe Basin, it is apparent in Figure 3.2-1 that HDR recharge estimates generally exceed those prepared by the USGS. This is likely due to the selection of different partner areas for estimating potential runoff from the areas in which the Edwards formation outcrops. Again, the marked difference in Blanco River recharge estimates for 1992 (which was the wettest year

---

<sup>3</sup> USGS, "Method of Estimating Natural Recharge to the Edwards Aquifer in the San Antonio Area, Texas." Water Resources Investigations 78-10, April, 1978.

<sup>4</sup> HDR, Op. Cit., September, 1993.



MEDINA /DIVERSION LAKE SYSTEM

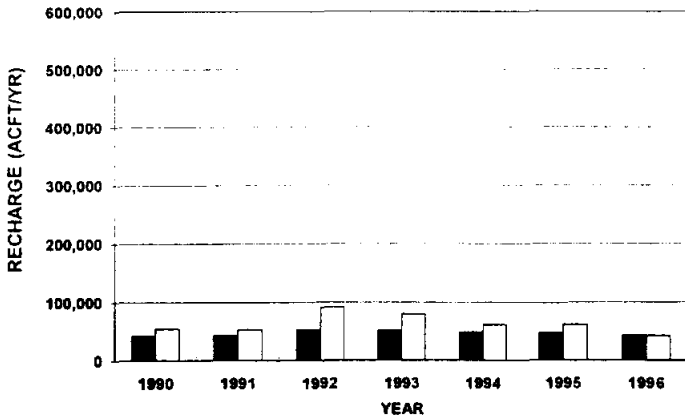

AREA BETWEEN MEDINA LAKE AND CIBOLO BASIN

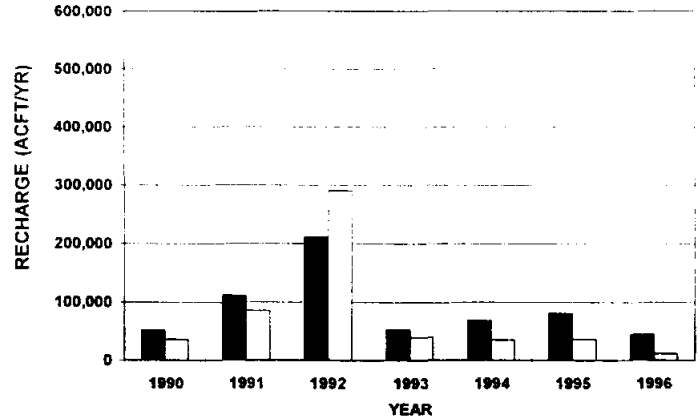

CIBOLO/DRY COMAL BASIN

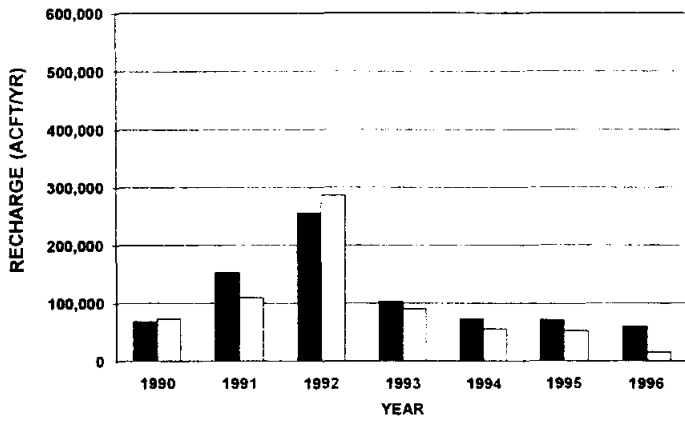

GUADALUPE BASIN

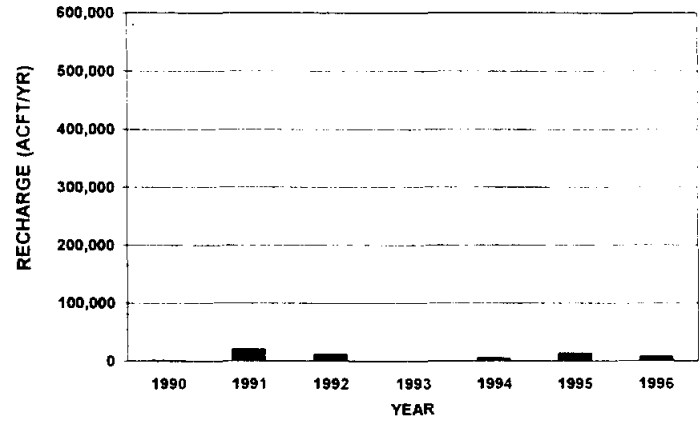

BLANCO BASIN

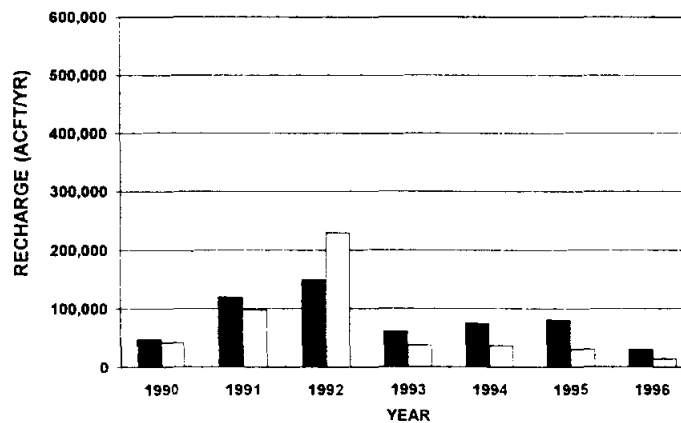

LEGEND

- HDR
- USGS

TRANS TEXAS WATER PROGRAM / WEST CENTRAL STUDY AREA

ANNUAL EDWARDS AQUIFER RECHARGE COMPARISONS GSA RIVER BASIN



HDR Engineering, Inc.

EDWARDS AQUIFER RECHARGE UPDATE

FIGURE 3.2-1

during the 1990-96 period) is likely explained by the USGS application of a base flow curve in their computation procedure.

Both the USGS and HDR estimates of annual recharge in the Medina / Diversion Lake System were computed using curves relating reservoir storage (or water surface elevation) to recharge rate. Applicable curves, however, were obtained from different sources. The USGS uses curves originally derived by Lowry<sup>5</sup> and HDR uses curves developed by Espey Huston & Associates.<sup>6</sup> It is likely that both sets of curves will soon be superseded by information in an upcoming USGS report on the Medina Lake Project which is presently under internal review.<sup>7</sup>

Also of note in Figure 3.2-1 is that HDR reports small annual estimates of Edwards Aquifer recharge occurring in the intervening Guadalupe River watershed between Canyon Reservoir and New Braunfels. The USGS reports that "the Guadalupe River crosses the infiltration area of the Edwards Aquifer, but does not contribute recharge in significant quantities."<sup>8</sup> HDR estimates indicate that annual recharge occurring in this area was as great as 20,363 acft during the 1990-96 period, but represents less than 2 percent of the long-term (1934-96) average recharge for the Edwards Aquifer in the Nueces and Guadalupe - San Antonio River Basins.

### 3.3 General Comparisons

As indicated in Appendix A, Edwards Aquifer recharge averaged about 652,700 acft/yr during the 1934-96 historical period. This is comparable to the published USGS estimate of 668,600 acft/yr which is about 2.4 percent greater. Table 3.3-1 and Figure 3.3-1 provide convenient summaries for geographical comparison of long-term average Edwards Aquifer recharge estimates developed by HDR and the USGS. Substantial differences, both in terms of volume and percentage, are readily apparent in specific recharge basins as only the Cibolo / Dry Comal recharge basin shows estimates within 10 percent of one another. In order to understand the differences between the HDR and USGS recharge estimates, basic methodologies and

---

<sup>5</sup> Lowry, R.L., "Recharge to the Edwards Ground Water Reservoir." San Antonio City Water Board, 1955.

<sup>6</sup> Espey, Huston & Associates, Inc., "Medina Lake Hydrology Study." Edwards Underground Water District, March, 1989.

<sup>7</sup> Lambert, R., Personal Communication. USGS, December, 1997.

<sup>8</sup> USGS, Op. Cit., April, 1978.

assumptions must be considered in some detail. The principal differences in recharge calculation methodology and procedures are associated with:

- Estimation of monthly potential runoff volumes for gaged and ungaged areas located atop the recharge zone (partner watershed, drainage area, areal precipitation, soil-cover complex, etc.);
- Base flow separation and accounting for storage in the Edwards Plateau Aquifer;
- Utilization of differing curves relating storage and recharge for the Medina / Diversion Lake System;
- Consideration of relatively small annual volumes of recharge for the Guadalupe River recharge basin; and
- Accounting for relatively small reported historical surface water diversions and treated effluent discharges.

For more detailed information on these differences, the reader is directed to referenced reports prepared by HDR and the USGS.

<b>River Basin</b>	<b>Recharge Basin</b>	<b>HDR Recharge Estimate (Acft/Yr)</b>	<b>USGS Recharge Estimate (Acft/Yr)</b>	<b>Difference (Acft/Yr)</b>	<b>Percent Difference</b>
	1. Nueces - W. Nueces	90,555	115,600	25,045	27.7%
	2. Frio - Dry Frio	114,824	131,900	17,076	14.9%
	3. Sabinal	33,201	41,400	8,199	24.7%
	4. Between Sabinal & Medina	95,818	105,500	9,682	10.1%
	Nueces	SUBTOTAL	334,398	394,400	60,002
	5. Medina	42,393	61,000	18,607	43.9%
	6. Between Medina & Cibolo	88,289	68,600	-19,689	-22.3%
	7. Cibolo - Dry Comal	110,307	103,300	-7,007	-6.4%
San Antonio	SUBTOTAL	240,989	232,900	-8,089	-3.4%
	8. Guadalupe	10,997	0	-10,997	-100.0%
	9. Blanco	66,322	41,300	-25,022	-37.7%
	Guadalupe	SUBTOTAL	77,319	41,300	-36,019
<b>TOTAL</b>		<b>652,706</b>	<b>668,600</b>	<b>15,894</b>	<b>2.4%</b>

Figure 3.3-2 provides two comparisons of HDR and USGS recharge estimates on a year by year basis for the entire 1934-96 historical period. Note that Edwards Aquifer recharge in 1992 was the greatest during the historical period (based on either HDR or USGS estimates) and

**HDR RECHARGE ESTIMATES  
(652,706 ACFT/YR)**

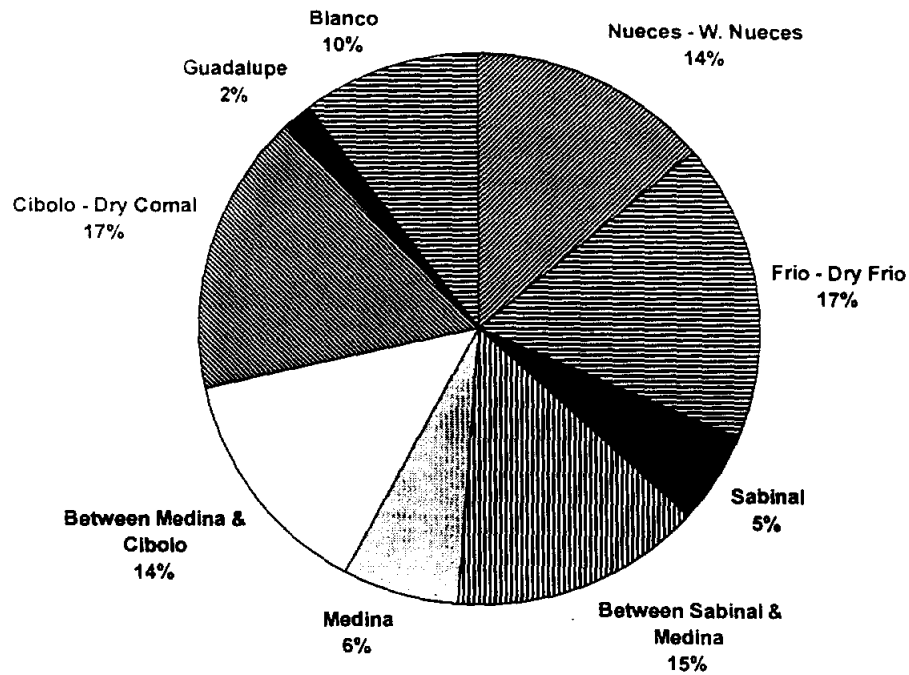

**USGS RECHARGE ESTIMATES  
(668,600 ACFT/YR)**

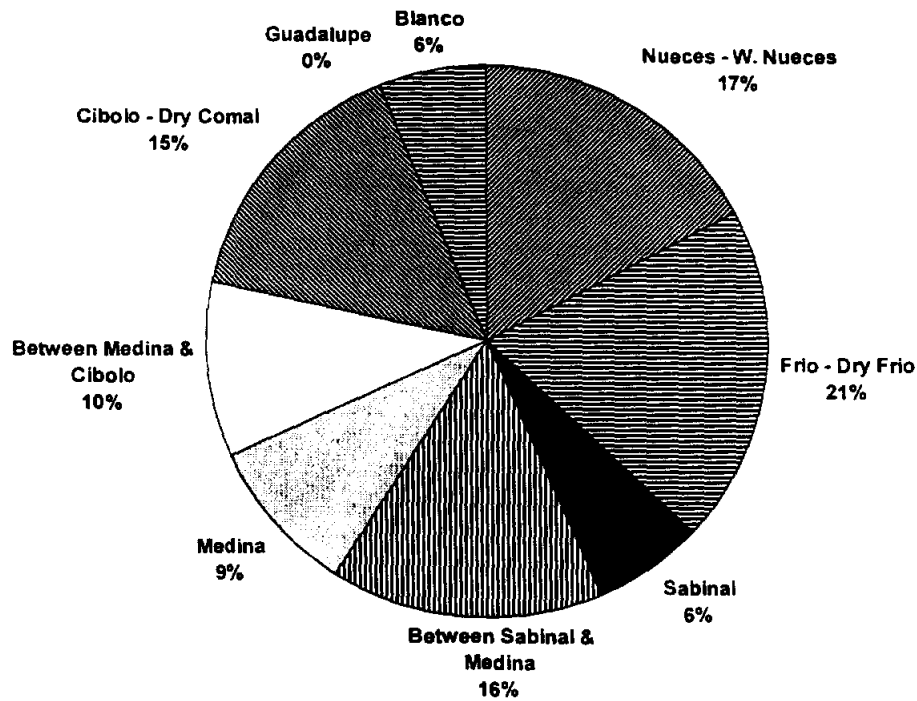

TRANS TEXAS WATER PROGRAM /  
WEST CENTRAL STUDY AREA

**GEOGRAPHICAL COMPARISON OF  
EDWARDS AQUIFER RECHARGE  
BY RECHARGE BASIN**



HDR Engineering, Inc.

EDWARDS AQUIFER  
RECHARGE UPDATE

FIGURE 3.3-1

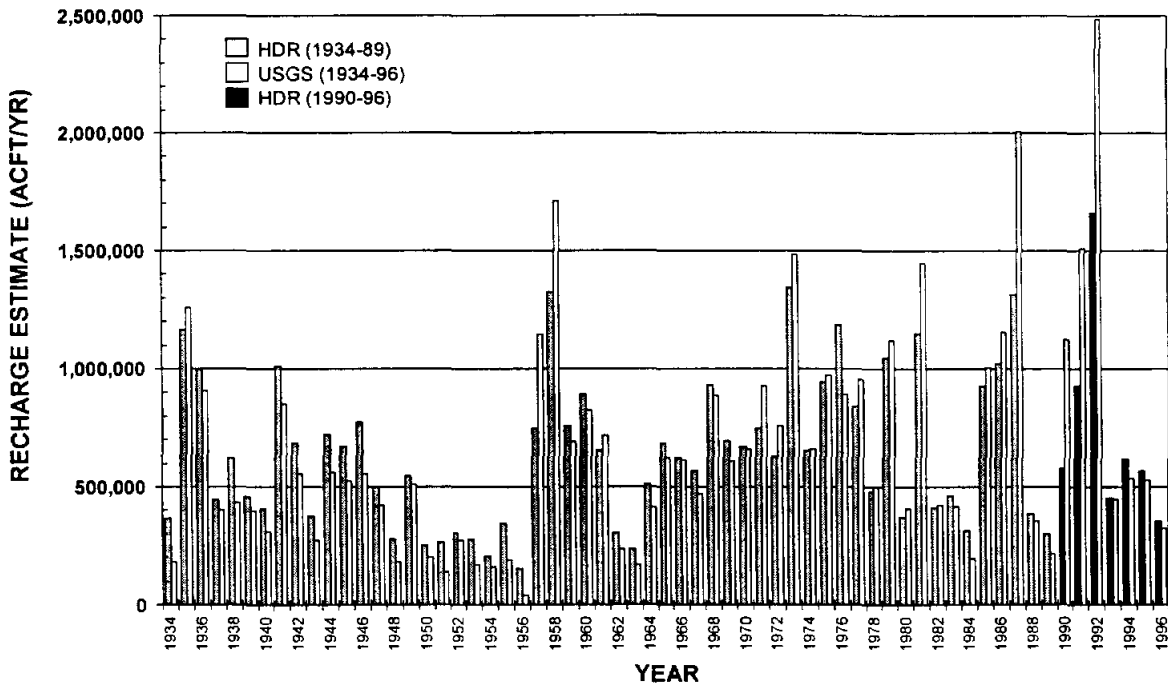
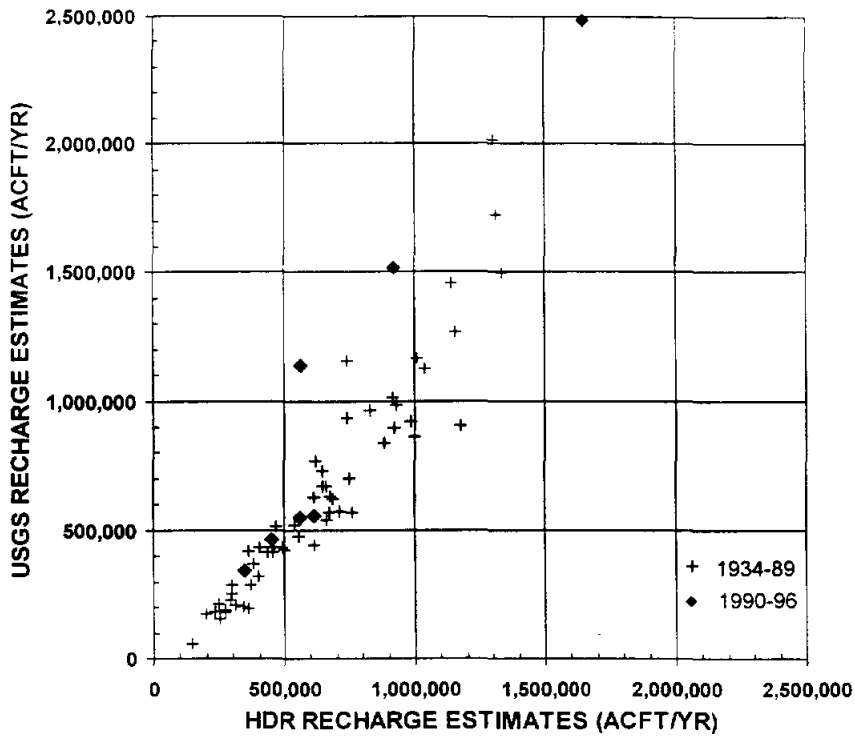

TRANS TEXAS WATER PROGRAM /  
WEST CENTRAL STUDY AREA

**LONG TERM EDWARDS AQUIFER  
RECHARGE COMPARISONS**



exceeded the next highest year by almost 20 percent. As is apparent in this figure, USGS recharge estimates are substantially greater than HDR estimates in the wettest years and somewhat less than HDR estimates in the driest years.

A comparison of the geographical distribution of long-term average Edwards Aquifer recharge on a river basin scale is presented in Figure 3.3-3. Clearly, USGS estimates are greater in the Nueces River Basin and substantially less in the Guadalupe River Basin. This difference in geographical recharge distribution is quite significant with respect to both calibration and application of Edwards Aquifer models. For example, complete reliance on USGS recharge estimates could result in overestimation of aquifer storage in the western counties and underestimation of reductions in well levels in San Antonio and springflows in Comal and Hays County. Similarly, complete reliance on USGS recharge estimates could result in overestimation of the effects of aquifer-wide pumpage on San Marcos Springs discharge due to underestimation locally occurring recharge in Hays County. Preliminary comparisons<sup>9</sup> indicate that the GWSIM4 model (originally calibrated using USGS recharge estimates) more accurately simulates historical springflows and Bexar County Monitoring Well levels when using HDR recharge estimates.

---

<sup>9</sup> HDR, Letter to Rick Illgner (EUWD), February, 28, 1994.

**HDR RECHARGE ESTIMATES  
(652,706 ACFT/YR)**

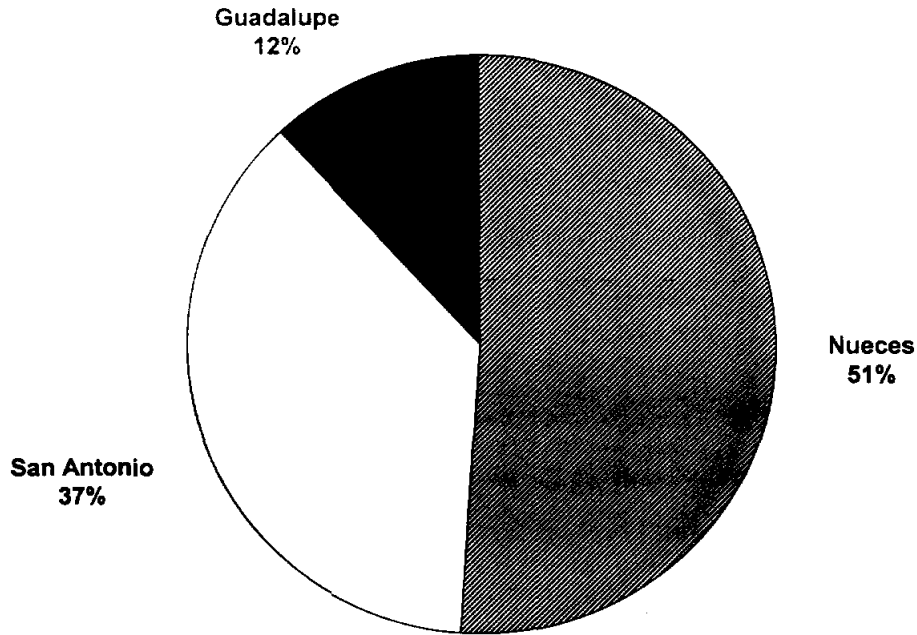

**USGS RECHARGE ESTIMATES  
(668,600 ACFT/YR)**

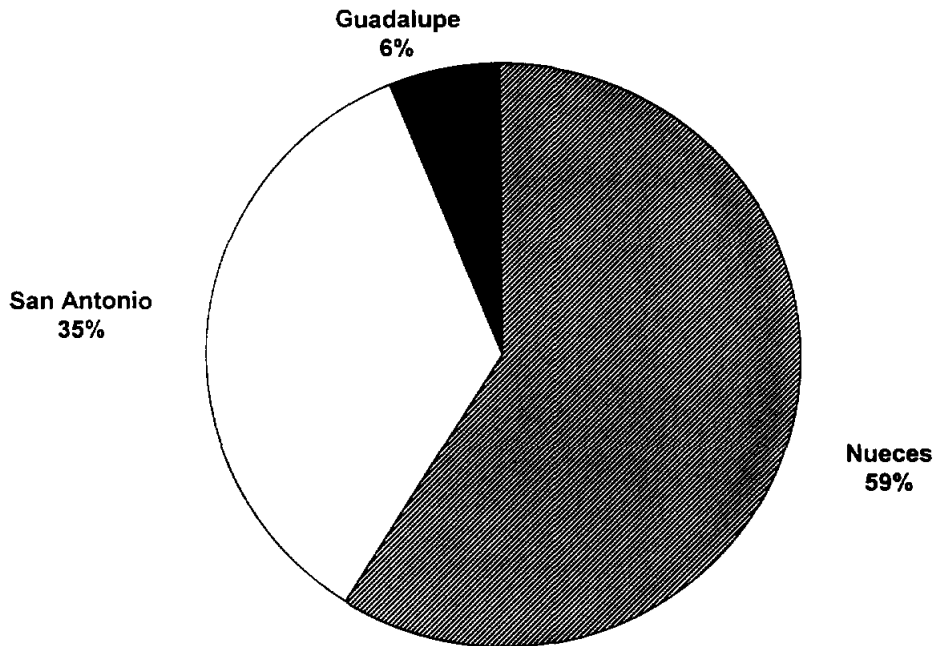

TRANS TEXAS WATER PROGRAM /  
WEST CENTRAL STUDY AREA

**GEOGRAPHICAL COMPARISON OF  
EDWARDS AQUIFER RECHARGE  
BY RIVER BASIN**

#### 4.0 RECOMMENDATIONS

The hydrologic extremes experienced during the 1990-96 historical period serve to reemphasize the importance of hydrologic data collection and periodic reassessment of methodologies applied in estimation of Edwards Aquifer recharge. The following are several recommendations regarding opportunities for improvement of recharge estimates:

- Data collection efforts implemented through the EAA precipitation and streamflow gaging network should be published on an annual basis as this data can contribute significantly to the accuracy of areal precipitation, potential runoff, and recharge estimates for all areas over the Edwards Aquifer recharge zone.
- Results of the Medina Lake Project when completed by BMA, BCA, and the USGS should be used to revise recharge relationships presently used for the Medina / Diversion Lake System.
- Results of a series of streamflow measurements on the Guadalupe River between Canyon Reservoir and New Braunfels conducted by the EAA, TWDB, and Guadalupe-Blanco River Authority should be analyzed and published, and recharge computation procedures revised accordingly.
- USGS records should be researched to determine if estimates of surface runoff for the portion of Upper San Marcos watershed above the springflow/streamflow gaging station located on the San Marcos River (#08170000) can be developed.
- Potential linkage of the EAA precipitation gaging network to advanced radar systems capable of measuring and recording the spatial distribution of precipitation intensity during storm events should be considered to improve estimates of areal precipitation.
- An improved, unified methodology for recharge calculation incorporating the best features of HDR and USGS procedures should be developed considering appropriate information from other studies and especially the EAA's ongoing data collection efforts.

Development of the best possible recharge computation procedures and, in turn, the best estimates of historical recharge are logical prerequisites for calibration and application of the most accurate aquifer model(s) possible. Ultimately, the best practicable Edwards Aquifer model must be developed to provide a sound technical basis for regulatory applications by both the EAA and TNRCC. Such a model will also prove invaluable in the technical evaluation of potential water supply plans involving conjunctive water supply management for the San Antonio region.



(This page intentionally left blank)

**APPENDIX A**  
**HISTORICAL EDWARDS AQUIFER RECHARGE ESTIMATES**

