

**CITY OF CLIFTON
AND
CITY OF MERIDIAN**

**REGIONAL
WATER SUPPLY
STUDY**

FINAL REPORT

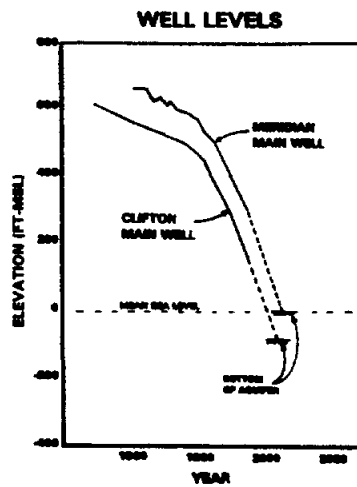
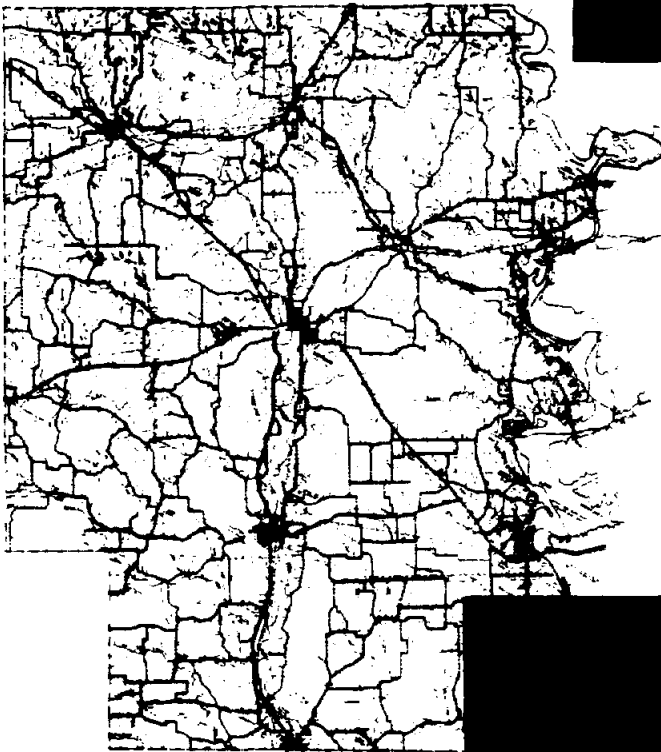

AUGUST, 1995



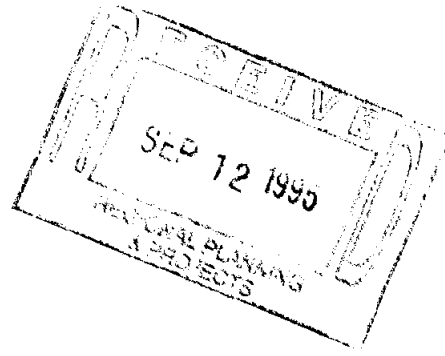

**CITY OF CLIFTON
AND
CITY OF MERIDIAN**

REGIONAL WATER SUPPLY STUDY

FINAL REPORT

PREPARED FOR

**CITY OF CLIFTON
CITY OF MERIDIAN
TEXAS WATER DEVELOPMENT BOARD**

AUGUST, 1995



HDR Engineering, Inc.



**REGIONAL WATER SUPPLY STUDY
CITY OF CLIFTON AND CITY OF MERIDIAN**

TABLE OF CONTENTS

Section

1.0	INTRODUCTION.....	1-1
1.1	Study Background	1-1
1.2	Study Area	1-2
1.3	Study Objectives.....	1-2
2.0	POPULATION AND WATER DEMAND PROJECTIONS.....	2-1
2.1	Population Projections.....	2-1
2.1.1	City of Clifton Population Projections.....	2-1
2.1.2	City of Meridian Population Projections.....	2-1
2.1.3	Bosque County Population Projections	2-4
2.2	Per Capita Water Use.....	2-6
2.3	Water Use Projections	2-7
2.3.1	City of Clifton Water Use Projections.....	2-7
2.3.2	City of Meridian Water Use Projections.....	2-7
2.3.3	Regional Water Use Projections	2-8
3.0	EXISTING GROUNDWATER SUPPLY	3-1
3.1	Groundwater Availability	3-1
3.2	Groundwater Quality	3-5
3.3	Need for Supplemental Surface Water Supply	3-5
3.4	Projected Surface Water Supply Needs	3-7
4.0	SURFACE WATER SUPPLY ALTERNATIVES	4-1
4.1	Background	4-1
4.2	General Description of Alternatives.....	4-2
4.3	Alternative 1 - Diversion from North Bosque River with Off-Channel Reservoir Storage	4-2
4.3.1	Surface Water Availability and Firm Yield	4-4
4.3.2	North Bosque River Water Quality.....	4-9
4.3.3	Water Treatment.....	4-13
4.3.4	Dams and Reservoirs	4-14
4.3.5	Regional Distribution System	4-24
4.3.6	Project Cost Estimate	4-24
4.4	Alternative 2 - Reservoir on Meridian Creek or Major Tributary	4-28
4.4.1	Surface Water Availability and Firm Yield	4-28
4.4.2	Water Quality.....	4-32
4.4.3	Water Treatment.....	4-32
4.4.4	Dams and Reservoirs	4-33
4.4.5	Regional Distribution System	4-37
4.4.6	Project Cost Estimate	4-37

4.5	Alternative 3 - Lake Whitney Demineralization	4-40
4.5.1	Surface Water Availability from Lake Whitney	4-40
4.5.2	Lake Whitney Water Quality	4-40
4.5.3	Water Treatment.....	4-41
4.5.4	Regional Distribution System	4-43
4.5.5	Project Cost Estimate	4-46
5.0	RECOMMENDED ALTERNATIVE AND IMPLEMENTATION PLAN	5-1
5.1	Recommended Alternatives	5-1
5.2	Implementation of the Recommended Alternative.....	5-2
5.3	Schedule for Implementation of Phase I.....	5-7
5.4	Water Supply Financing Options.....	5-9
5.4.1	Bond Market.....	5-9
5.4.2	Texas Water Development Board Fund	5-10
5.4.3	State Participation Fund	5-11
5.4.4	Community Development Block Grants.....	5-12
5.4.5	Rural Economic & Community Development Grants and Loans.....	5-13

References

Appendix - Regional Water Conservation and Emergency Demand Management Plan

LIST OF FIGURES

Figure No.	Title	Page No.
1-1	Study Area	1-3
2-1	Population Projections for Clifton and Meridian	2-2
2-2	Population Projections for Bosque County	2-5
2-3	Municipal Water Demand Projections for Clifton and Meridian.....	2-9
3-2	Geologic Section, Bosque County	3-2
3-3	Hydrographs of Selected Wells in Bosque County	3-3
3-4	Historic and Projected Well Levels for Clifton and Meridian	3-4
3-4	Geologic Outcrops.....	3-6
4-1	Surface Water Supply Alternatives.....	4-3
4-2	North Bosque River Annual Flow	4-6
4-3	North Bosque River, Monthly Flows During Drought Period of 1982-1984.....	4-7
4-4	Regional Water Treatment Plant Process Schematic.....	4-15
4-5	Regional Water Treatment Plant Conceptual Site Layout.....	4-16
4-6	Typical Section, Earth Dam.....	4-18
4-7	Typical Profile, Off-Channel Dam	4-19
4-8	Alternative 1A, Off-Channel Reservoir near Clifton	4-21
4-9	Alternative 1B, Off-Channel Reservoir near Meridian.....	4-22
4-10	Channel Dam, Bosque River.....	4-23
4-11	Alternative 1A, Regional System	4-25
4-12	Alternative 1B, Regional System	4-26
4-13	Spring Creek Reservoir Operation Simulation.....	4-31
4-14	Typical Profile, Meridian Creek Dam	4-34
4-15	Alternative 2, Spring Creek Reservoir.....	4-36
4-16	Alternative 2, Regional System	4-38
4-17	Lake Whitney Water Treatment Plant Process Schematic.....	4-42
4-18	Lake Whitney Water Treatment Plant Conceptual Layout	4-44
4-19	Alternative 3, Lake Whitney Regional System.....	4-45
5-1	Phase I Monthly Supply Pattern	5-4
5-2	Phase I Implementation Schedule	5-8

LIST OF TABLES

Table No.	Title	Page No.
2-1	Population Projections for Clifton, Meridian, and Bosque County, Texas	2-3
2-2	Population Growth Rates for Clifton, Meridian, and Bosque County, Texas	2-4
2-3	Projected Per Capita Water Use for Clifton and Meridian, Texas	2-6
2-4	Projected Municipal Demands for Clifton and Meridian, Texas	2-8
4-1	Alternative 1A, Off-Channel Reservoir Storage Requirements	4-8
4-2	Alternative 1B, Off-Channel Reservoir Storage Requirements	4-9
4-3	Alternative 1, Available Water Quality Data	4-11
4-4	Alternative 1A - Project Cost Estimate	4-27
4-5	Alternative 1B - Project Cost Estimate	4-27
4-6	Alternative 2 - Meridian Creek Reservoirs	4-30
4-7	Alternative 2 - Project Cost Estimate	4-39
4-8	Alternative 3 - Available Water Quality Data	4-41
4-9	Alternative 3 - Project Cost Estimate	4-47
5-1	Summary of Costs for Alternatives, Year 2050	5-1
5-2	Project Cost Estimate - Phase I, Recommended Project - Alternative 1A	5-6

1.0 INTRODUCTION

1.1 Study Background

The City of Clifton and City of Meridian are located in Bosque County and currently serve a total population of about 4,800 people. The two cities have met their water supply needs from local groundwater resources, which have been gradually depleting as water demands have increased in the region.

In 1982, a county-wide regional water supply study (HDR, 1982) identified Lake Bosque (a large dam proposed on the Bosque River upstream of Meridian) as the most feasible long-term water supply solution for the county, if other communities such as the City of Waco participated in its development. The City of Clifton and City of Meridian were both participants in the proposed Lake Bosque project, directed by the Brazos River Authority, which along with the enlargement of the existing Lake Waco, was considered a regional water supply solution for both cities along with other entities in McLennan County including the City of Waco, City of Bellmead, City of Hewitt, City of Lacy-Lakeview, City of Woodway, and McLennan County Water Control and Improvement District No. 2. Water rights permits were issued in 1991 for both projects. However, after issuance of the permits, the City of Waco determined that sufficient water was available from the enlargement of Lake Waco to meet the needs previously anticipated by the McLennan County entities (i.e. City of Waco, City of Bellmead, City of Hewitt, City of Lacy Lakeview, City of Woodway, and McLennan County WCID No. 2) and that having their water supplied by the City of Waco from Lake Waco, rather than from Lake Bosque, was in their best interest. In September of 1994, an agreement (“Windup Agreement”) was executed between the Lake Bosque project participants and the Brazos River Authority that essentially terminated the Lake Bosque project. As part of the agreement, the entities in Bosque County, which included the City of Clifton and the City of Meridian, may apply for water rights in an amount up to 3,340 acre-feet per year from the North Bosque River watershed which may be considered prior in right and superior to the rights in Lake Waco. With the termination of the Lake Bosque project, the City of Clifton and the City of Meridian did not have a water supply plan to meet their future needs.

In September of 1994, the two cities applied for grant funds from the Texas Water Development Board (TWDB) Research and Planning Fund to develop a regional water supply plan for Clifton and Meridian. In cooperation with the City of Meridian, the City of Clifton entered into a contract with the TWDB in January of 1995 for matching funds. HDR Engineering, Inc. (HDR) was retained by Clifton and Meridian on February 13, 1995 to serve as the consultant for the development of a regional water supply plan.

1.2 Study Area

The study area includes lands within the incorporated areas of the City of Clifton and the City of Meridian (See Figure 1-1). The study area is located within the boundaries of Bosque County and the Brazos River Basin in north central Texas. The principal source of water for municipal and domestic use in Bosque County has been groundwater from the Travis Peak Formation. The North Bosque River originates in Erath County and flows southeasterly through Bosque County in the immediate vicinity of the City of Meridian and City of Clifton. Significant flows occur in the North Bosque River during normal conditions, and the river serves as an important water supply and recreational resource for the region.

1.3 Study Objectives

The overall objective of this study is to provide a plan to conserve existing water supplies and to guide the implementation of a new surface water supply source for Clifton and Meridian to supplement the present groundwater supply. To accomplish this objective, the following tasks were undertaken as components of this regional water supply study.

Task 1.0 Determine existing and projected population served and water demands.

Using TWDB projections, recent studies in the planning area, and analysis of water utility records, projections of population and water demands for Clifton and Meridian were made to the year 2050. The projections establish future water needs for Clifton and Meridian.

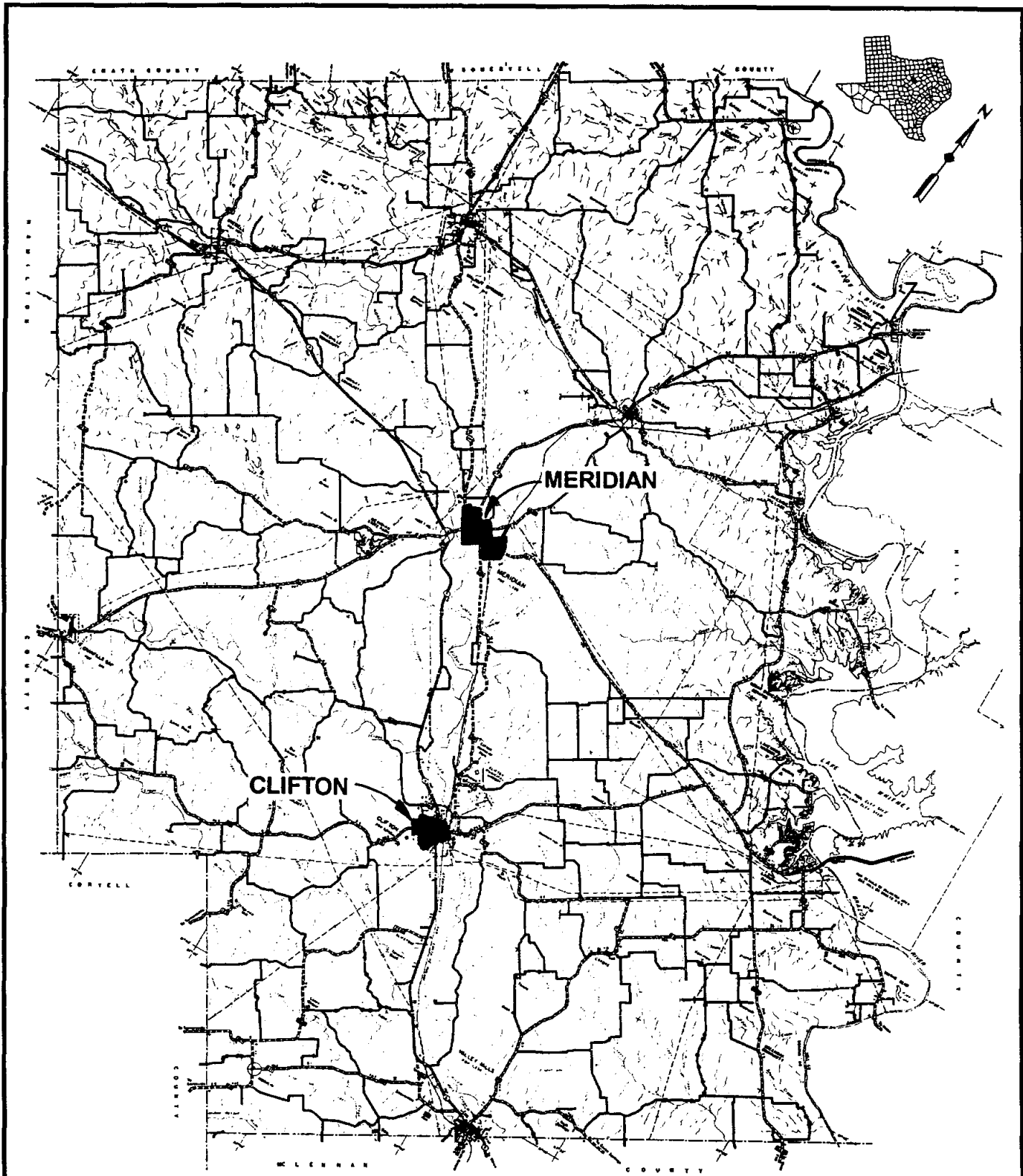

CITY OF CLIFTON AND CITY OF MERIDIAN
REGIONAL WATER SUPPLY STUDY

STUDY AREA



HDR Engineering, Inc.

FIGURE 1-1

Task 2.0 Regional Water Conservation and Emergency Demand Management Plan

A water conservation and emergency demand management has been prepared in accordance with TWDB guidelines to promote the efficient use of water, extend the life of existing supplies, and reduce the costs of new or supplemental water supplies (Appendix A).

Task 3.0 Alternative 1: Evaluate the feasibility of a surface water supply alternative using an off-channel storage reservoir, river intake and diversion facilities, surface water treatment plant, and transmission facilities.

Two potential sites were identified for off-channel reservoirs, one near Clifton and one near Meridian, using readily available mapping. Reconnaissance level field investigations were performed to examine site conditions. Surface water availability at Clifton and Meridian was assessed under the terms of the "Windup Agreement" and Clifton's existing 600 acre-feet per year water right. The firm yield of the two sites was computed for selected storage volumes and river diversion rates. River intake and diversion facilities near Clifton and Meridian were evaluated. Because of the benefits of Clifton's existing water right at the present location, a river intake site at the "Old Mill Dam" site, where the diversion point is located, was considered. Surface water treatment plant requirements were analyzed based on water quality data available on the North Bosque River. Cost estimates for the selected off-channel reservoir sites, river intake and diversion facilities, and surface water treatment plant and transmission facilities were developed.

Task 4.0 Alternative 2: Evaluate the feasibility of a surface water supply alternative of a dam and reservoir on Meridian Creek including surface water treatment plant and transmission facilities.

Potential dam and reservoir sites on Meridian Creek and its major tributaries were identified using readily available mapping. Reconnaissance level field investigations were performed to examine site conditions. The availability of surface water at each of the potential sites was analyzed under the terms and conditions of the "Windup Agreement." Surface water treatment plant requirements were evaluated based on available water quality data. Cost estimates for the selected dam and reservoir, surface water treatment plant, and transmission facilities were developed.

Task 5.0 **Alternative 3: Evaluate the feasibility of a surface water supply alternative utilizing the existing supply available from Lake Whitney including surface water demineralization treatment and transmission facilities required to deliver treated water to Clifton and Meridian.**

Cost estimates were updated for desalination treatment of Lake Whitney water presented in past studies. Cost estimates were developed for transmission facilities to deliver treated water to Clifton and Meridian.

Task 6.0 **Develop procedures and schedule for implementation of the selected alternative and identify sources of funding.**

An outline for implementation of the selected alternative was developed. The outline includes the steps required for permits from state and federal agencies, environmental impact assessments, legal, engineering, right-of-way acquisition and easements, bid documents, bidding, and construction. A schedule for the implementation of the selected alternative was also prepared. Sources of financing were identified and described.

Task 7.0 **Meetings and Reports**

Coordination meetings, which were open to the public, were held in March, June, and August of 1995 to discuss the status of the study and solicit input from the public. A representative of the TWDB attended the meetings. A draft report was prepared and submitted to the City of Clifton, City of Meridian, and TWDB for review and comment. The final report was prepared after consideration of the review comments.

SECTION 2 - POPULATION AND WATER DEMAND PROJECTIONS

2.0 POPULATION AND WATER DEMAND PROJECTIONS

2.1 Population Projections

Population projections for the City of Clifton, City of Meridian, and Bosque County were prepared for the year 2000 through 2050 in order to define the quantities of water needed by each city at various points in time. Population projections for low and high growth rate scenarios were made for both cities. Although both low and high growth rate scenarios are presented, the high growth rate scenario is normally used for water plan development and it was adopted for use in this study.

2.1.1 City of Clifton Population Projections

The population of Clifton has increased 74 percent over a 40-year period from 1,837 in 1950 to 3,195 in 1990. Over the next 40-year period (1990 to 2030), the population is expected to increase by 44 percent, increasing to 4,599 (see Figure 2-1). For the planning period to the year 2050, the population is projected to increase from its current estimate in 1995 of 3,371 to 5,340. Table 2-1 presents low and high growth rate projections for Clifton, Meridian, and Bosque County and compares the estimates to those prepared by the Texas Water Development Board (TWDB, 1995) for the “most likely scenario.” The HDR low case projections compare well with the TWDB’s most likely population projection for Clifton, while the HDR high case projection is approximately 8 percent higher. The HDR high case projection is based upon the assumption that the City of Clifton growth rate from 1990 to 2010 will continue at the historic rate observed for the 1970 to 1990 period of 1.08 percent compound annual rate, while the TWDB projection is based upon a growth rate of 0.73 percent for the same period. Recent housing and commercial development activity in Clifton, including the Main Street Program initiated in Clifton in 1994, supports the higher growth rate used in the HDR high case projection and was adopted for use in this study.

2.1.2 City of Meridian Population Projections

The population of Meridian increased 21 percent over the 40-year period of 1950 (population = 1,146) to 1990 (population = 1,390). Over the next 40-year period (1990 to 2030),

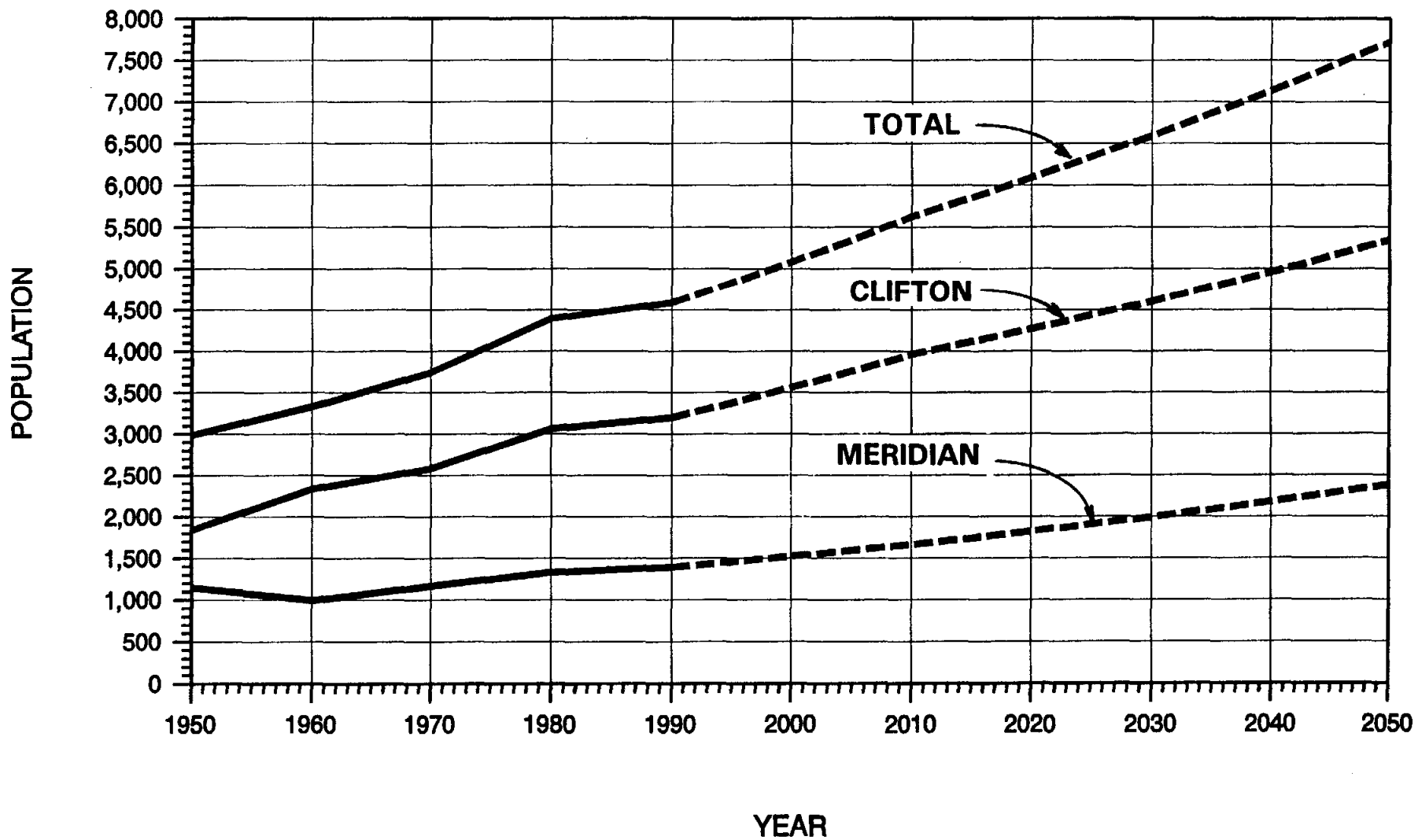

NOTE: HDR HIGH CASE PROJECTIONS.



HDR Engineering, Inc.

CITY OF CLIFTON AND CITY OF MERIDIAN
REGIONAL WATER SUPPLY STUDY

**POPULATION PROJECTIONS
FOR CLIFTON AND MERIDIAN**

FIGURE 2-1

SECTION 2 - POPULATION AND WATER DEMAND PROJECTIONS

Year	Texas Water Development Board ²			HDR Engineering ³					
	Bosque County	Clifton	Meridian	Bosque County		Clifton		Meridian	
				Low	High	Low	High	Low	High
Historical¹									
1950	11,836	1,837	1,146	11,836	11,836	1,837	1,837	1,146	1,146
1960	10,809	2,335	993	10,809	10,809	2,335	2,335	993	993
1970	10,966	2,578	1,162	10,966	10,966	2,578	2,578	1,162	1,162
1980	13,401	3,063	1,303	13,401	13,401	3,063	3,063	1,303	1,303
1990	15,125	3,195	1,390	15,125	15,125	3,195	3,195	1,390	1,390
Projections									
1995				16,070	16,390	3,313	3,371	1,441	1,453
2000	17,069	3,443	1,504	17,075	17,761	3,436	3,557	1,494	1,520
2005				18,142	19,248	3,563	3,754	1,549	1,590
2010	19,196	3,667	1,603	19,276	20,858	3,695	3,961	1,607	1,662
2015				20,360	22,162	3,832	4,111	1,666	1,738
2020	21,542	4,102	1,791	21,505	23,547	3,974	4,268	1,728	1,818
2030	23,893	4,507	1,966	23,990	26,583	4,274	4,599	1,858	1,989
2040	25,174	4,715	2,057	26,032	30,009	4,596	4,956	1,999	2,175
2050	28,142	4,933	2,152	28,247	35,545	4,943	5,340	2,150	2,379

Notes:
 1) U.S. Bureau of the Census, U.S. Dept. of Commerce.
 2) Texas Water Development Board, "Most Likely Series," January, 1995
 3) HDR projections based on growth rate estimates as shown in Table 2-2.

the population is projected to increase by 43 percent to 1,989. For the planning period to the year 2050, the population is projected to increase from its current estimate in 1995 of 1,453 to 2,379. A summary of the low and high growth rate projections for Meridian is included in Table 2-1. Similar to the City of Clifton projections, the HDR low case projections closely match the TWDB most likely projection and the HDR high case projections are about 10 percent higher. The HDR high case projection is based upon the 1970 to 1990 historic growth rate of 0.90 percent. The higher growth rate was selected for use in this water supply plan and is supported by recent efforts to increase growth in the area such as the Bosque County Economic Development Program that was initiated in 1995 (located in Meridian) and was not known at the time of the TWDB projections.

SECTION 2 - POPULATION AND WATER DEMAND PROJECTIONS

Table 2-2 Population Growth Rates for Clifton, Meridian, and Bosque County, Texas						
Period	Bosque County		Clifton		Meridian	
	Low	High	Low	High	Low	High
Historical						
1970-1980	2.02%	2.02%	1.74%	1.74%	1.36%	1.36%
1980-1990	1.22%	1.22%	0.42%	0.42%	0.44%	0.44%
1970-1990	1.62%	1.62%	1.08%	1.08%	0.90%	0.90%
Projected						
1990-1995	1.22% ^a	1.62% ^d	0.73% ^g	1.08% ^h	0.73% ^j	0.90% ^k
1995-2000	1.22% ^a	1.62% ^d	0.73% ^g	1.08% ^h	0.73% ^j	0.90% ^k
2000-2005	1.22% ^a	1.62% ^d	0.73% ^g	1.08% ^h	0.73% ^j	0.90% ^k
2005-2010	1.22% ^a	1.62% ^d	0.73% ^g	1.08% ^h	0.73% ^j	0.90% ^k
2010-2015	1.10% ^b	1.22% ^e	0.73% ^g	0.75% ⁱ	0.73% ^j	0.90% ^k
2015-2020	1.10% ^b	1.22% ^e	0.73% ^g	0.75% ⁱ	0.73% ^j	0.90% ^k
2020-2030	1.10% ^b	1.22% ^e	0.73% ^g	0.75% ⁱ	0.73% ^j	0.90% ^k
2030-2040	0.82% ^c	1.22% ^e	0.73% ^g	0.75% ⁱ	0.73% ^j	0.90% ^k
2040-2050	0.82% ^c	1.22% ^f	0.73% ^g	0.75% ^l	0.73% ^j	0.90% ^k

Notes:
a) 1980-1990 rate
b) TWDB rate for 2010-2030
c) TWDB rate for 2030-2050
d) 1970-1990 rate
e) 1980-1990 rate
f) TWDB rate for 2040-2050
g) TWDB rate for 2010-2050
h) 1970-1990 rate
i) TWDB rate for 1990-2050
j) TWDB rate for 1990-2050
k) 1970-1990 rate
l) Texas State growth rate for 1970-1990 was 2.11 percent

2.1.3 Bosque County Population Projections

The Bosque County population projections are included in this study to give a perspective on growth in surrounding areas and to provide a background for the development of the projections for Clifton and Meridian. The population of Bosque County increased 28 percent over the 40-year period of 1950 (population = 11,836) to 1990 (population = 15,125). For the water supply planning period which extends to the year 2050, the population of Bosque County is expected to increase to 33,545, over two times the current 1995 population estimate of 16,390. For Bosque County, the HDR low case projections closely match the TWDB most likely projection with the HDR high case projection about 19 percent higher in the year 2050. The HDR high case projections are based upon growth rates experienced during the 1970 to 1990 period which are expected to be sustained by the recent economic development programs. As shown in Figure 2-2, the projected overall growth rate for Bosque County is expected to be greater than the growth rates for Clifton and Meridian. The City of Clifton and City of Meridian

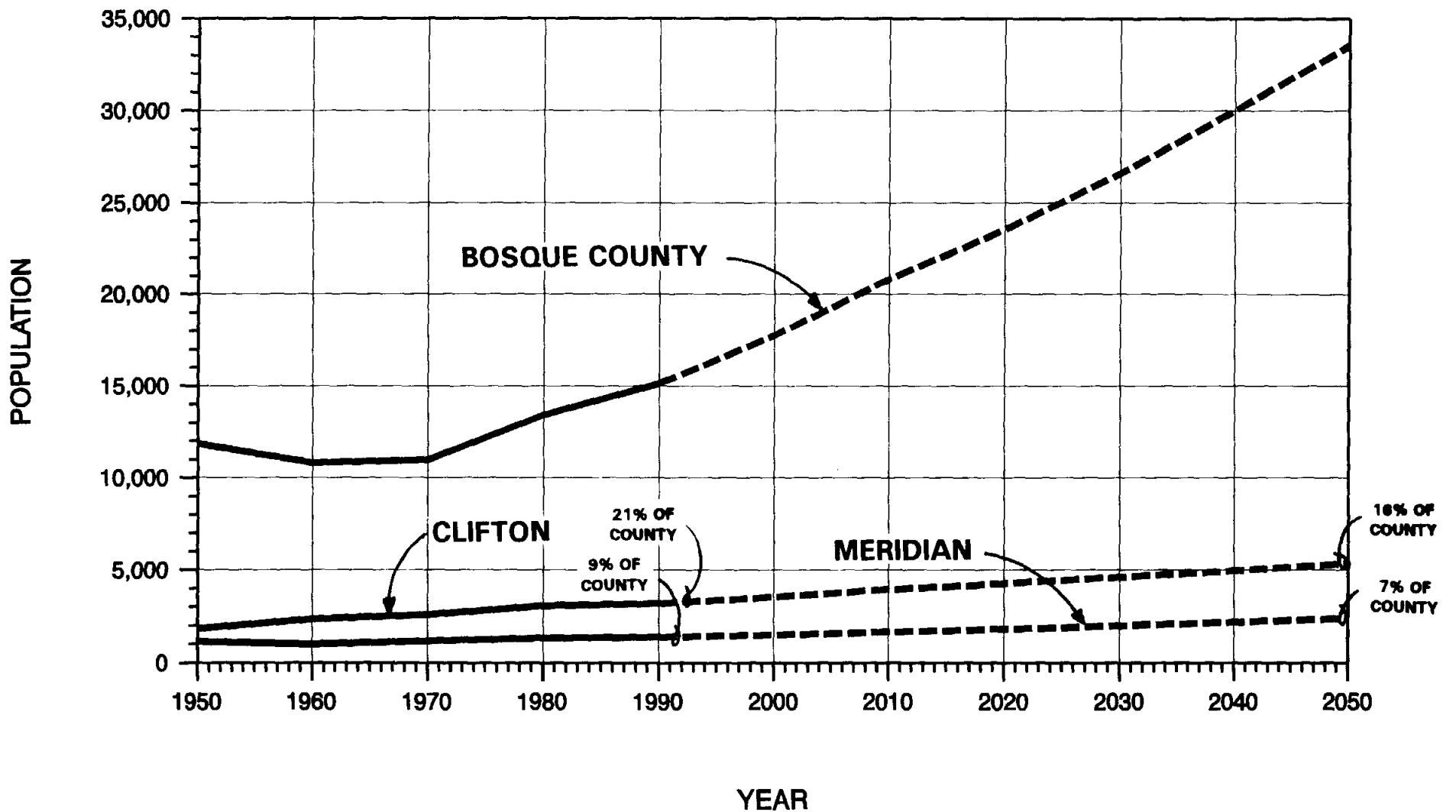

NOTE: HDR HIGH CASE PROJECTIONS.



HDR Engineering, Inc.

CITY OF CLIFTON AND CITY OF MERIDIAN
REGIONAL WATER SUPPLY STUDY

**POPULATION PROJECTIONS
FOR BOSQUE COUNTY**

FIGURE 2-2

SECTION 2 - POPULATION AND WATER DEMAND PROJECTIONS

population made up about 30 percent of the total population of Bosque County in 1990. By the year 2050, this percentage is projected to drop to 23 percent, indicating higher growth is expected in the rural areas of Bosque County.

2.2 Per Capita Water Use

Per capita water use, in terms of the average volume of water used per person per day, has fluctuated from 197 gallons for Clifton in 1980 to 138 gallons in 1990 (See Table 2-3). For Meridian, per capita water use in 1980 was 138 gallons and in 1990 was 150 gallons (See Table 2-3). A per capita water use statistic of 160 gallons per person per day was selected for use in making water demand projections for 1995 for both Clifton and Meridian.

Year	Texas Water Development Board (gallons per person per day)		HDR Engineering (gallons per person per day)	
	Clifton	Meridian	Clifton	Meridian
<u>Historical</u>				
1980	197	138	197	138
1981	165	241	165	241
1982	169	184	169	184
1983	150	160	150	160
1984	162	186	162	186
1985	136	171	136	171
1986	128	180	128	180
1987	124	155	124	155
1988	127	159	127	159
1989	130	153	130	153
1990	138	150	138	150
1991	103	140	103	140
1992	130	135	130	135
1993	169	162	169	162
1994	152	148	152	148
<u>Projected</u>				
1995			160	160
2000	157	178	157	157
2005			155	155
2010	152	173	152	152
2015			150	150
2020	147	168	150	150
2030	144	165	150	150
2040	141	162	150	150
2050	140	160	150	150

Notes: 1) Below normal precipitation, with plumbing fixtures, only, for conservation.

SECTION 2 - POPULATION AND WATER DEMAND PROJECTIONS

Since 160 gallons per person per day is a fairly low water use rate, especially for dry weather conditions, it was projected that the water conservation effects of low flow plumbing fixtures and other water conservation programs would only be capable of reducing per capita water use by about 6 percent over the next 20 years to a level of 150 gallons per person per day. The per capita water use rates shown in Table 2-3 were used in making water demand projections for Clifton and Meridian, respectively, for the period of 1995 through 2050.

2.3 Water Use Projections

Projections of annual water demand for each city for the 1995 to 2050 planning period were made by multiplying the projected per capita water use rate of 160 gallons per person per day times the projected population at the desired point in time. This figure represents the total average daily demand for each year in terms of gallons per day. In order to express the average demand in acre-feet per year (ac-ft/yr) which are common units used in water supply planning, the average daily demand in gallons per day is divided by 325,851.

2.3.1 City of Clifton Water Use Projections

The City of Clifton's reported water use in 1980 was 677 acre-feet, in 1990 was 495 acre-feet, and more recently in 1994 was 549 acre-feet (See Table 2-4 and Figure 2-2). The HDR high case water demand projection for Clifton in 1995 is 604 acre-feet based on the high case population projections and estimated per capita water use with conservation practices. Projected high case water demands are expected to increase over the next 20 years to 690 acre-feet in the year 2015, to 773 acre-feet in the year 2030, and, ultimately, to 897 acre-feet in the year 2050. The resulting high case water demand projections for Clifton in the year 2050 is about 16 percent higher than the TWDB most likely projections as shown in Table 2-4.

2.3.2 City of Meridian Water Use Projections

The City of Meridian's reported water use was 202 acre-feet in 1980, 233 acre-feet in 1990, and more recently in 1994 was 249 acre-feet (See Table 2-4 and Figure 2-2). The HDR

SECTION 2 - POPULATION AND WATER DEMAND PROJECTIONS

Table 2-4									
Projected Municipal Demands for Clifton and Meridian, Texas¹									
Year	Texas Water Development Board (acre-feet per year) ²			HDR Engineering, Inc. (acre-feet per year) ²					
	Clifton	Meridian	Total	Clifton		Meridian		Total	
				Low ³	High ⁴	Low ³	High ⁴	Low ³	High ⁴
Historical									
1980	677	202	879	677	677	202	202	879	879
1990	495	233	728	495	495	233	233	728	728
Projections									
1995				593	604	258	260	851	864
2000	605	300	905	604	625	263	267	867	892
2005				618	652	269	276	887	928
2010	624	311	935	629	674	274	283	903	957
2015				643	690	280	292	923	982
2020	675	337	1,012	667	717	290	305	957	1,022
2030	727	363	1,090	718	773	312	334	1,030	1,107
2040	745	373	1,118	772	832	336	365	1,108	1,197
2050	774	388	1,162	830	897	361	400	1,191	1,297

Notes:
 * TWDB most likely case, January 1995 consensus water planning information.
 1) Below normal precipitation, with plumbing fixtures, only, for conservation.
 2) One acre-foot equals 325,851 gallons. 1,120 acre-feet per year equals 1 mgd.
 3) Low population projections from Table 2-1
 4) High population projections from Table 2-1.

high case water demand projection for Meridian in 1995 is 260 acre-feet based on the high case population projections and estimated per capita water use with conservation practices. Projected high case water demands are expected to increase over the next 20 years to 292 acre-feet in the year 2015, to 334 acre-feet in the year 2030, and ultimately to 400 acre-feet in the year 2050. The resulting high case water demand projection for Meridian in the year 2050 is only about 3 percent higher than the TWDB most likely projections as shown in Table 2-4.

2.3.3 Regional Water Use Projections

Water supply alternatives in this study are to be evaluated on a regional basis to meet the total water needs of both Clifton and Meridian. Therefore, the projected water demands for the regional system are the combined water demands for both Clifton and Meridian. Total water use for both cities was 879 acre-feet in 1980, 728 acre-feet in 1990, and more recently in 1994 was 798 acre-feet (See Table 2-4 and Figure 2-3). The HDR high case water demand projections show that the regional water demand over the next 20 years will increase to 982 acre-feet by the

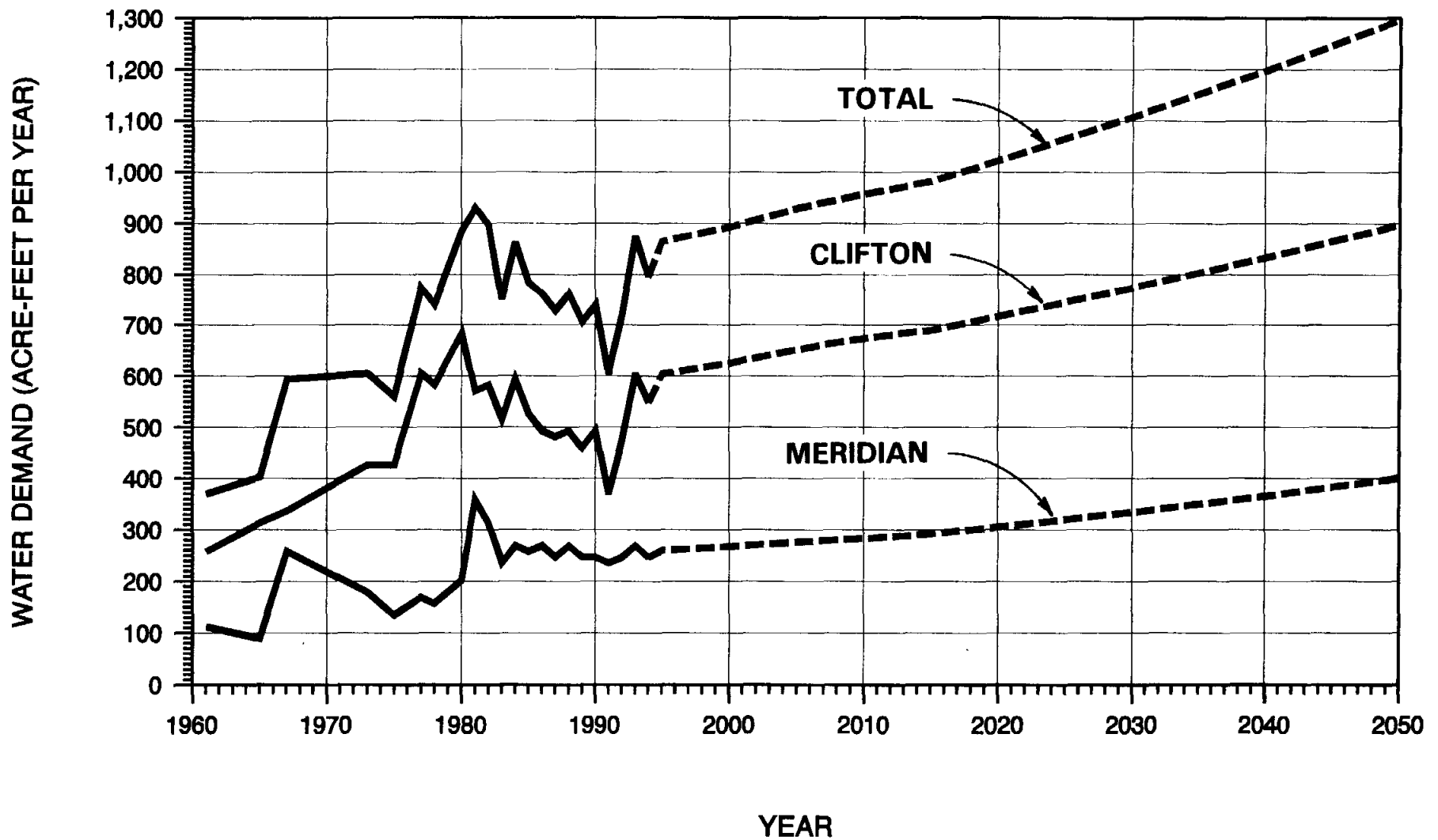

NOTE: WATER DEMAND PROJECTIONS
 BASED ON HDR HIGH CASE WITH
 IMPLEMENTATION OF CONSERVATION.



HDR Engineering, Inc.

CITY OF CLIFTON AND CITY OF MERIDIAN
 REGIONAL WATER SUPPLY STUDY

**MUNICIPAL WATER DEMAND
 PROJECTIONS FOR CLIFTON
 AND MERIDIAN**

FIGURE 2-3

SECTION 2 - POPULATION AND WATER DEMAND PROJECTIONS

year 2015, to 1,107 acre-feet by the year 2030, and ultimately to 1,297 acre-feet by the year 2050. The resulting regional high case water demand projections for Clifton and Meridian in the year 2050 is about 12 percent higher than the TWDB most likely projections as shown in Table 2-4. The high case water demand projections were reviewed and adopted by the City of Clifton and City of Meridian for use in this planning study.

SECTION 3- EXISTING GROUNDWATER SUPPLY

3.0 EXISTING GROUNDWATER SUPPLY

3.1 Groundwater Availability

The City of Clifton and City of Meridian presently obtain all of their water supply from groundwater sources. The principal water bearing aquifer underlying the two cities is the Travis Peak Formation (See Figure 3-1). The Hensell and Hosston members of this formation provide the municipal water supply for Clifton and Meridian as well as most of the other entities in Bosque County. These members have a fresh water sand thickness ranging from 50 feet to 120 feet. The Hensell and Hosston aquifers are the primary sources of groundwater throughout this part of Central Texas (TWDB, 1975). These members have been ideal in the past for the development of wells since they exhibited artesian properties. During the early twentieth century, wells completed in these formations would flow at the surface. However, due to overdevelopment, the artesian surface or water levels in Bosque County have demonstrated steady declines as shown in Figure 3-2 (TWDB, 1994).

Historical water levels for the primary water wells for Clifton and Meridian were summarized in a 1982 regional water supply study for Bosque County (HDR, 1982) which shows how water levels have declined since the 1950's (See Figure 3-3). In the early 1950's, well levels in the City of Clifton were about 640 feet above sea level (ft-msl) or about 15 feet below the land surface at the city's well field at the northeast edge of town. Records indicate that the water level has steadily declined for the past 40 years in the range of 10 to 20 feet per year. Recent measurements indicate that pumping levels in the Clifton wells are nearing the top of the Hensell Aquifer and may have already occurred in some wells. Well levels for the City of Meridian were at an elevation of about 695 feet-msl in the early 1960's or about 125 feet to 150 feet below the land surface. Present well levels are about 400 feet-msl, a decline of over 290 feet. The rate of well level decline in the Meridian area has been about 10 to 12 feet per year (TWDB, 1994).

Projections of future well levels were made in the 1982 Regional Water Supply Study for Bosque County and well levels were estimated to reach the water bearing strata of the aquifer by the year 2005 for both Clifton and Meridian. Using 1995 well level data for both cities, the predictions made as part of the 1982 study were found to compare well with actual well levels

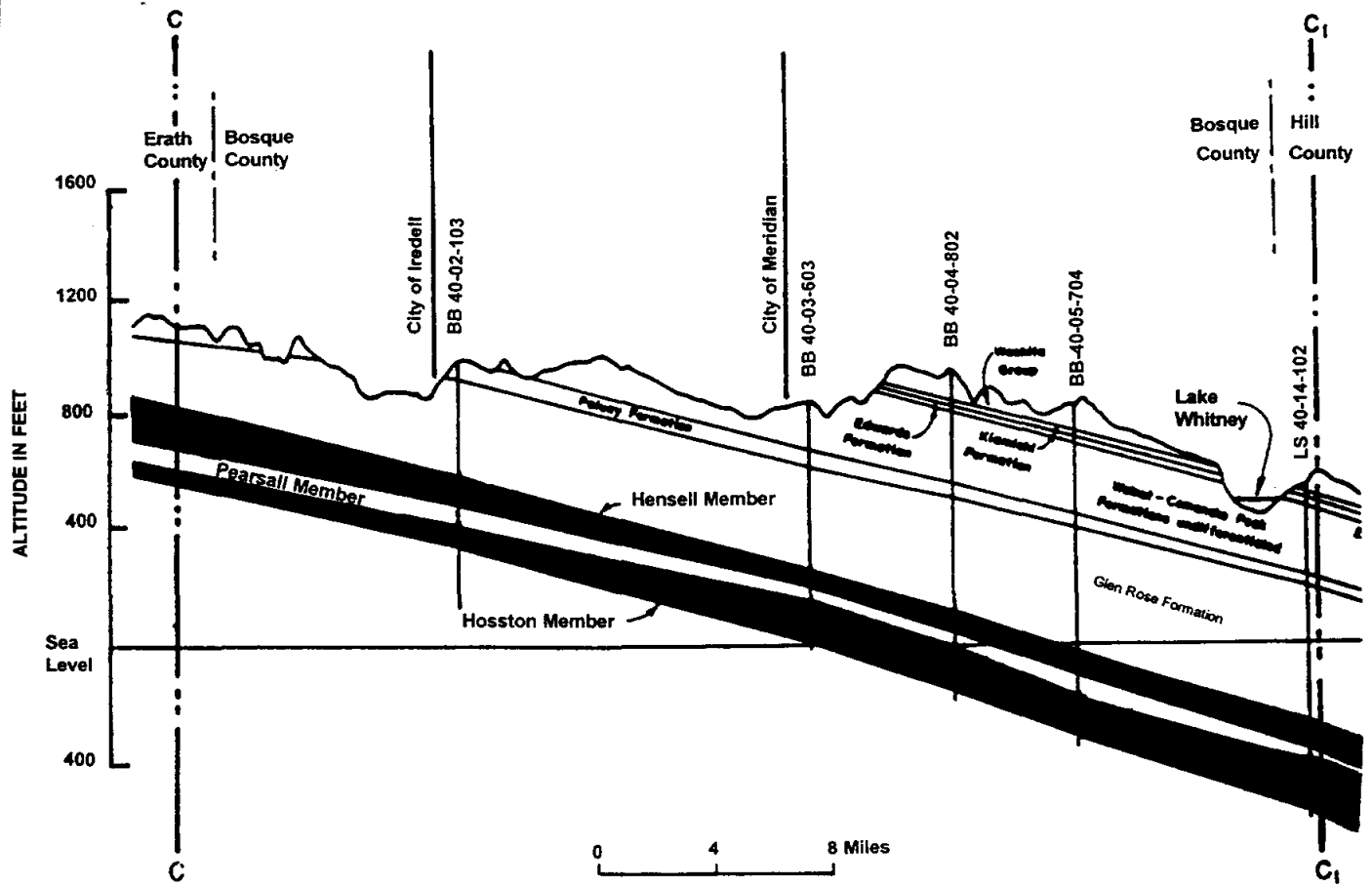

Geologic Section

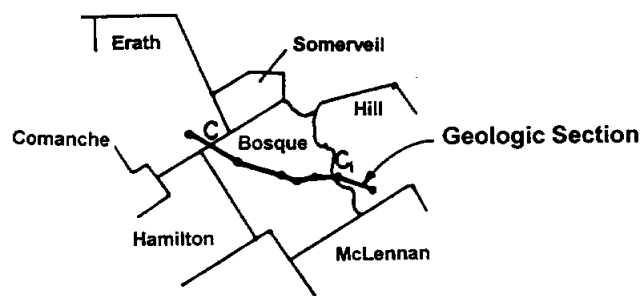

CITY OF CLIFTON AND CITY OF MERIDIAN
REGIONAL WATER SUPPLY STUDY

**GEOLOGIC SECTION
BOSQUE COUNTY**

SOURCE: TEXAS WATER
DEVELOPMENT BOARD



HDR Engineering, Inc.

FIGURE 3-1

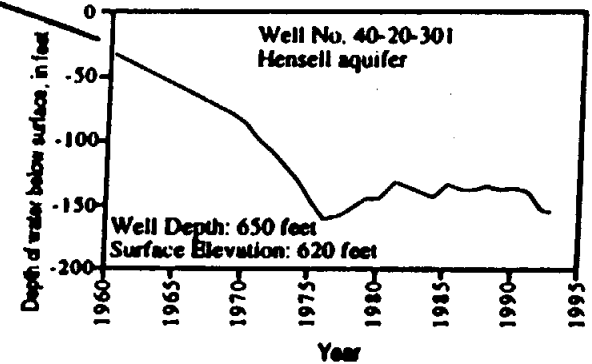
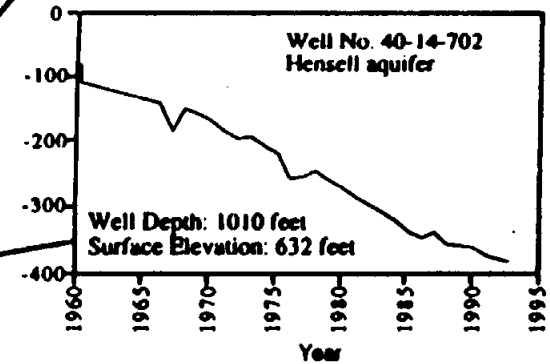
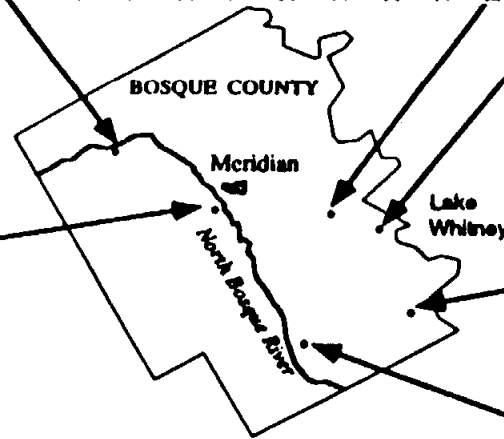
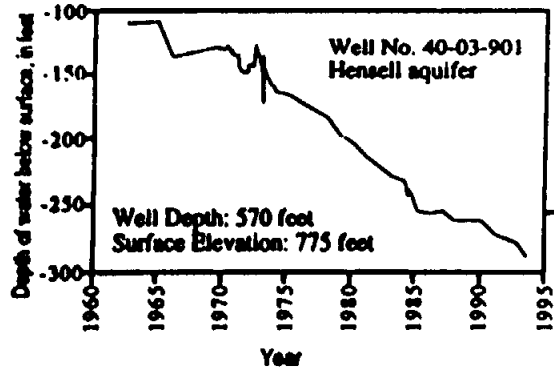
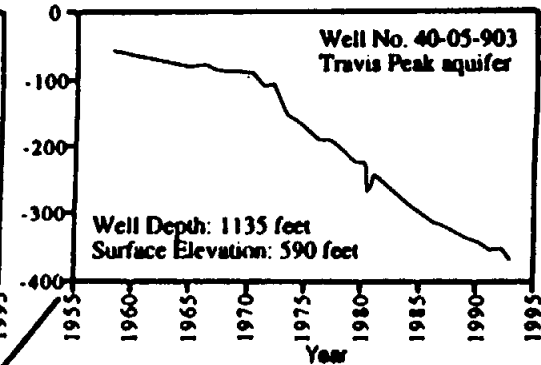
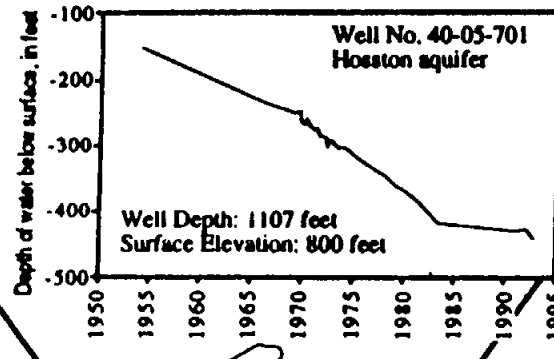
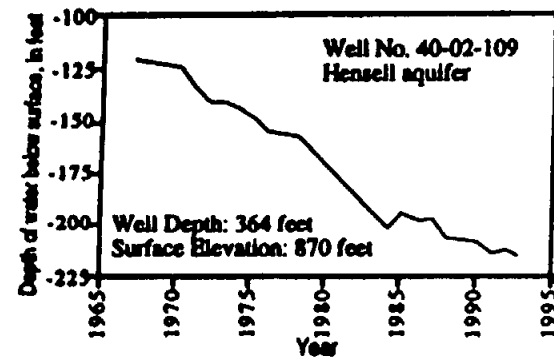

SOURCE: TEXAS WATER DEVELOPMENT BOARD

CITY OF CLIFTON AND CITY OF MERIDIAN
REGIONAL WATER SUPPLY STUDY

HYDROGRAPHS OF SELECTED WELLS
IN BOSQUE COUNTY



HDR Engineering, Inc.

FIGURE 3-2

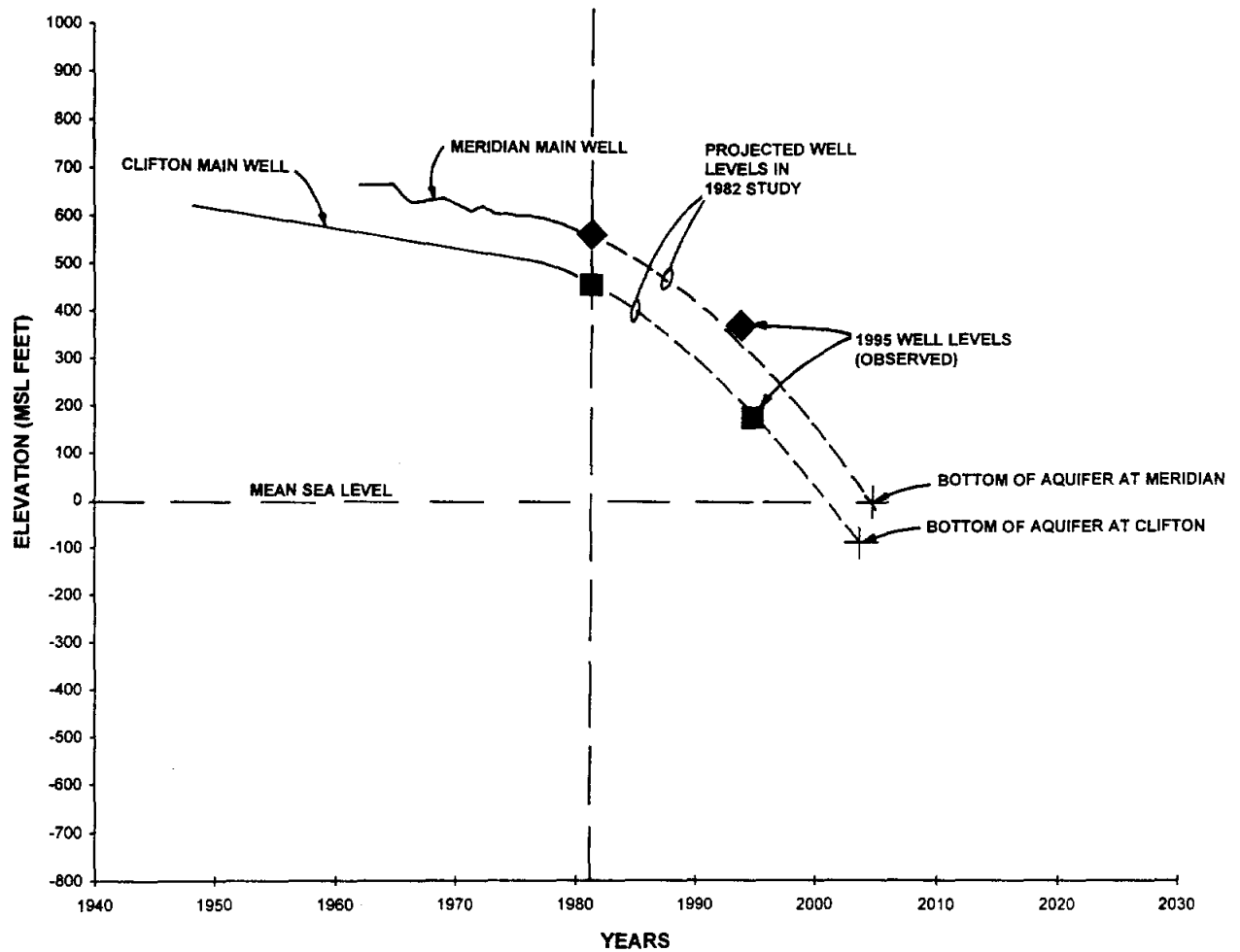

CITY OF CLIFTON AND CITY OF MERIDIAN
REGIONAL WATER SUPPLY STUDY



HDR Engineering, Inc.

**HISTORIC AND PROJECTED
WELL LEVELS FOR
CLIFTON AND MERIDIAN**

FIGURE 3-3

SECTION 3- EXISTING GROUNDWATER SUPPLY

for Clifton and slightly over-estimated the rate of decline for Meridian. If future water demands in Bosque County continue to be met by groundwater supply, well level declines can be expected to continue at their current rates or possibly decline even more rapidly. Compounding this problem is the fact that the Travis Peak Formation underlies at least 15 other counties in Central Texas and has been heavily developed (See Figure 3-4). Water level declines in the Hensell and Hosston formations will correlate directly to higher energy costs (since water in the well must be pumped from lower levels), lower well yields, and could potentially result in poorer quality water.

3.2 Groundwater Quality

Generally, the water quality in the Hensell and Hosston aquifers in Bosque County from which Clifton and Meridian presently obtain their municipal water supply meets all the primary and secondary standards set for drinking water by the Texas Natural Resource Conservation Commission (TNRCC). However, continued water level declines in Bosque County could cause an area of poor quality water in the Hensell Aquifer, located in southeastern Bosque County and extending into McLennan County, to migrate further northward into Bosque County (TWDB, 1994). This area of poor quality water is excessively high in total dissolved solids, exceeding the TNRCC drinking water standard of 1000 milligrams per liter (mg/l). Total dissolved solids in the Hosston Aquifer currently meet the primary and secondary drinking water standards. There does not appear to be any evidence of migration of poor quality water into the Hosston Aquifer in Bosque County (TWDB, 1994).

3.3 Need for Supplemental Surface Water Supply

The rapid decline in well levels all across Bosque County demonstrates the need to develop a supplemental water supply to augment the present groundwater supply and meet future water demands. Current projections show that the wells supplying Clifton and Meridian may have difficulty meeting the water supply needs of the two cities by the year 2005, assuming the water supply needs for the existing population and future growth in the region are met from groundwater. Projected growth in the rural areas of Bosque County (refer to Figure 2-2) and

BOSQUE COUNTY

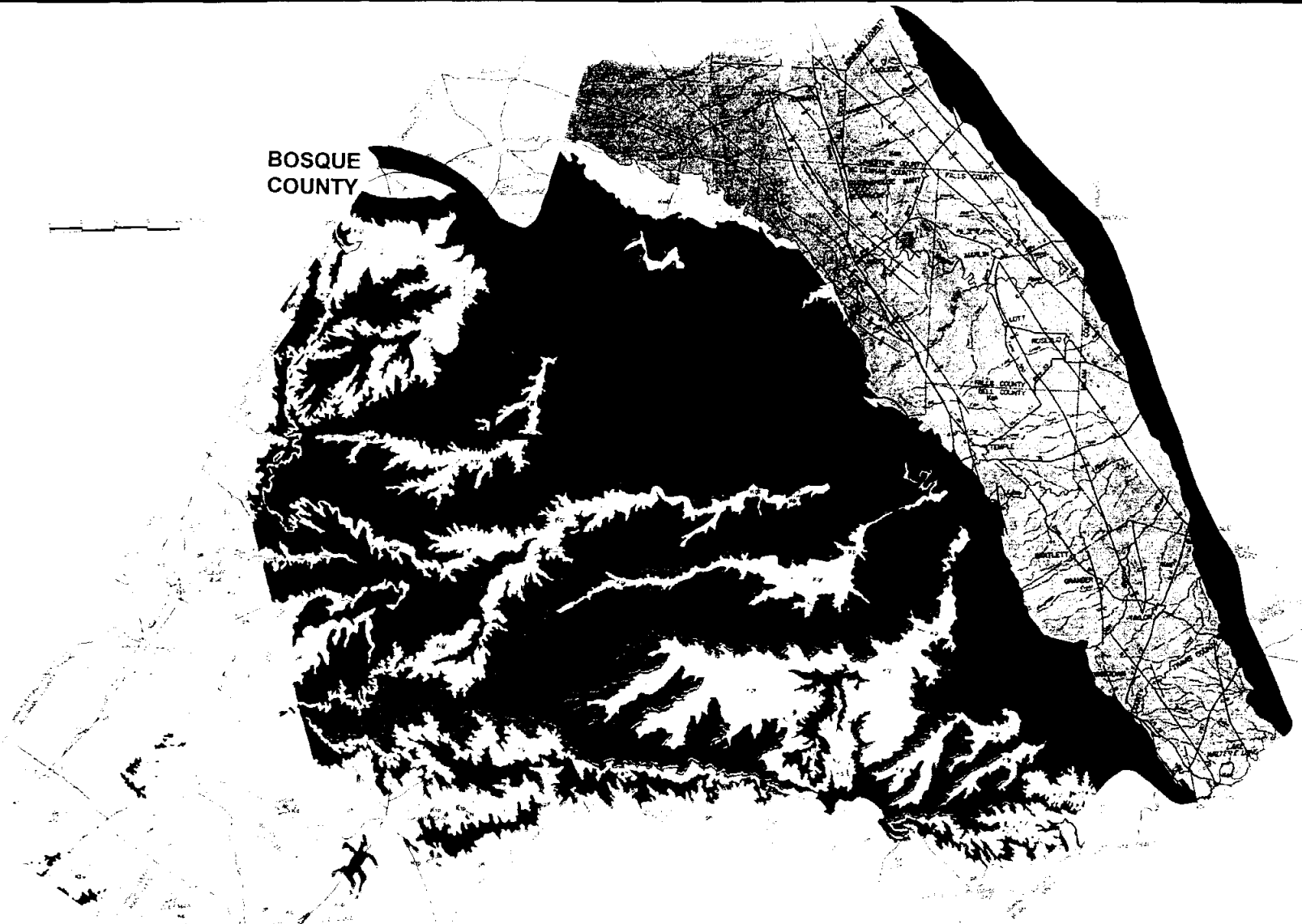

EXPLANATION

	Tertiary rocks, undifferentiated and all city and pressure tests limit to large amounts of water.
	Eocene to Pliocene (Taylor and Natchitoches) undifferentiated. These are untested, no data and some tests show amounts of water to water locally.
	Woodbine Group. Good and some tests show to moderate amounts of water.
	Fredericksburg and Houston Groups, undifferentiated. Moderate water. (Clifton city and not available. Tests show to large amounts of water).
	Trinity Formation. Some untested and some tests show to moderate amounts of water.
	Lower Permian. Moderate water and some tests show amounts of water to water locally.
	Travis Peak Formation. Consistent and some and moderate tests show to large amounts of water.
	Artisan Formation. Very fine and some moderate tests show to moderate amounts of water.
	The Paleozoic rocks, undifferentiated. These are untested, no data, no data and no data. Tests show to moderate amounts of water in western and northwestern areas.
	Unconformity. Shaded where located or approximately located.
	Fault. Location and direction and shaded where approximately located. (Clifton city and not available).

CITY OF CLIFTON AND CITY OF MERIDIAN REGIONAL WATER SUPPLY STUDY

GEOLOGIC OUTCROPS

SCALE 1:500,000



HDR Engineering, Inc.

FIGURE 3-4

SOURCE: TEXAS WATER DEVELOPMENT BOARD

SECTION 3- EXISTING GROUNDWATER SUPPLY

surrounding counties is expected to be significant and the source of water for the rural areas will most likely be from groundwater. If a supplemental water supply is developed, the beneficial use of the present groundwater supply could be extended by reducing the demand and the rates of decline in aquifer levels, especially in the immediate vicinity of both cities.

3.4 Projected Surface Water Supply Needs

The objective of this study is to evaluate potential alternatives for development of a surface water supply to supplement the present groundwater supply. Projection of availability of future groundwater supplies is beyond the scope of this study. However, with the development of a supplemental surface water supply, groundwater supplies are expected to provide at least a portion of the water supply needs of Clifton and Meridian until the year 2030.

SECTION 4 - SURFACE WATER SUPPLY ALTERNATIVES

4.0 SURFACE WATER SUPPLY ALTERNATIVES

4.1 Background

Three surface water supply alternatives capable of meeting the future water supply needs of Clifton and Meridian were investigated. The criteria used for sizing and cost estimating were the same, providing a consistent basis for comparison. Estimates of total project cost and annual power and operation and maintenance costs were made for each alternative. Total capital cost and annual costs were calculated to provide a common economic basis for comparison.

The water supply alternatives were evaluated with consistent sizing of system components, and were sized to meet the projected municipal water demands in the year 2050 to determine the most economic long-term water supply solution. Water treatment plants, pump stations, and pipelines were sized to meet the year 2050 peak day demands (approximately 2.5 times the average day demand). In evaluating the alternatives, allowances were provided to maintain minimum flows for fish and wildlife in rivers and streams where appropriate. Reservoirs on major tributaries and off-channel reservoirs on minor tributaries were sized to provide storage for a firm supply for year 2050 conditions. Selection of potential reservoir sites was based on proximity to existing facilities, topographic suitability for construction, and proximity to sources of raw water. Treated water was delivered to each city at existing ground storage facilities to supply each city's water distribution system.

The estimated construction costs for each alternative were based on 1995 construction cost information derived from similar type projects. More detailed analyses will be required to refine the costs prior to design, financing, and implementation of the selected project, however, the cost estimates are considered to be appropriate for comparing alternatives. Total project costs include right-of-way and relocation costs, 10 percent for construction contingencies, and 15 percent for permitting, engineering, legal, and financial services. The annual debt service factor was calculated assuming financing at an interest rate of 7.0 percent for 25 years. The interest rate currently being offered by the Texas Water Development Board is 6.6 percent. Power costs were calculated using a unit cost of \$0.07 per kilowatt-hour. Annual operation and maintenance (O&M) costs were estimated as one percent of the total construction cost, except for water treatment plants. For water treatment plants, annual O&M costs were developed based on the

SECTION 4 - SURFACE WATER SUPPLY ALTERNATIVES

treatment capacity and treatment process. Alternatives were compared on a similar economic basis by calculating the total annual costs. Total annual costs were computed by adding the individual annual costs for debt service, power, O&M, and water purchases.

4.2 General Description of Alternatives

Three surface water supply alternatives were evaluated as part of this study. These alternatives can generally be described as:

- Alternative 1: Diversion from North Bosque River with off-channel reservoir storage;
- Alternative 2: Reservoir on Meridian Creek or major tributary of Meridian Creek; and
- Alternative 3: Lake Whitney with demineralization water treatment.

Alternative 1 is further subdivided into an evaluation of diversion from the North Bosque River and storage in an off-channel reservoir located near Clifton (Alternative 1A) and diversion from the North Bosque River and storage in an off-channel reservoir located near Meridian (Alternative 1B). Three potential off-channel reservoir sites were evaluated near Clifton and three potential sites were evaluated near Meridian as part of Alternative 1A and Alternative 1B, respectively. A total of five potential reservoir sites were evaluated on Meridian Creek and its tributaries as part of Alternative 2. Alternative 3 involved updating cost estimates for demineralization treatment of water from Lake Whitney and transmission to Clifton and Meridian. Lake Whitney is located approximately 13 miles east of Clifton and of Meridian. A summary of the alternatives considered and the potential reservoir sites that were evaluated for each alternative is presented in Figure 4-1.

4.3 Alternative 1 - Diversion from North Bosque River with Off-Channel Reservoir Storage

The concept of an off-channel dam and storage reservoir is to pump raw water from a river or stream when flow in the river is adequate (sometimes referred to as “scalping”) and the store it for future use during dry periods. Typically, the watershed area above an off-channel

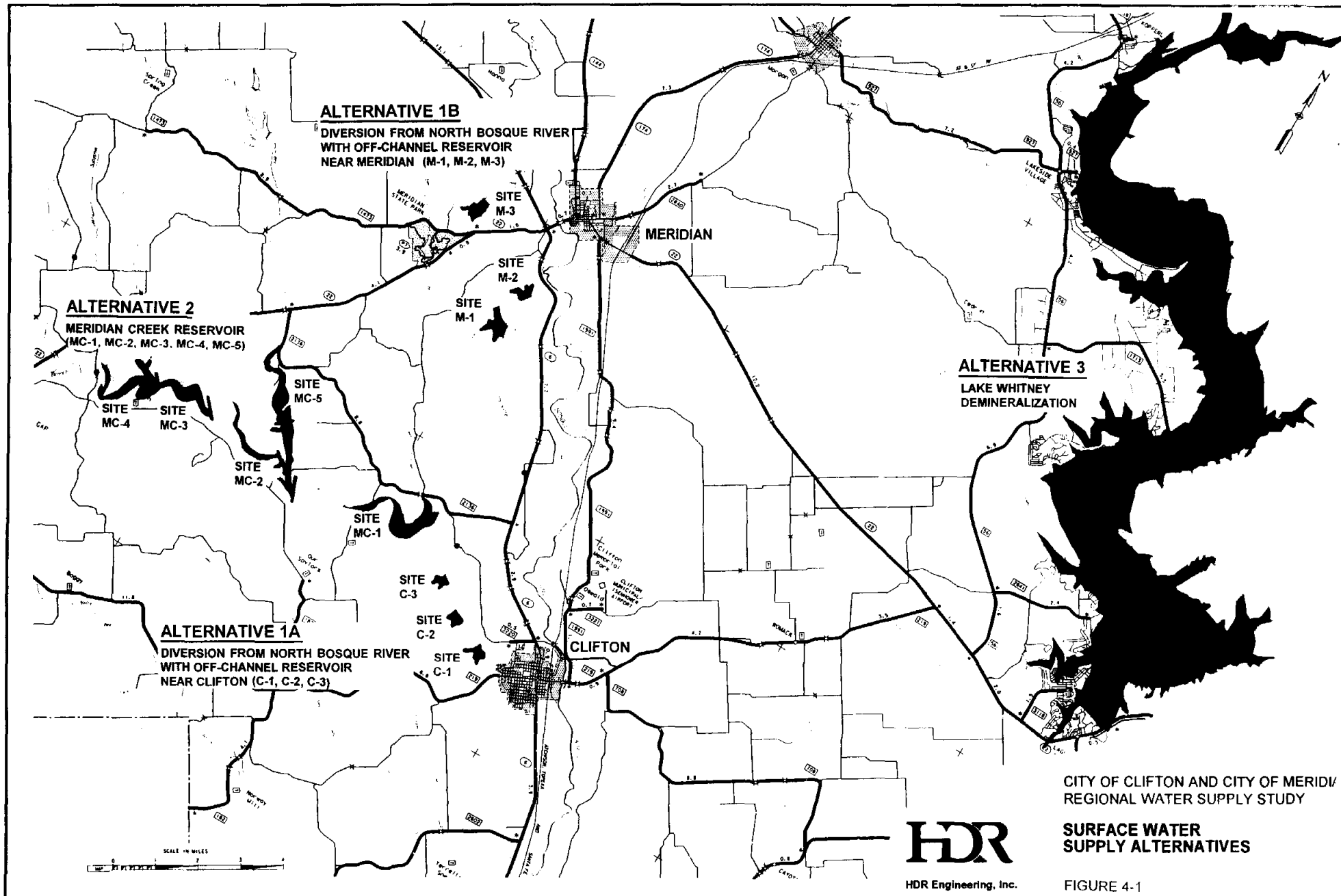

SECTION 4 - SURFACE WATER SUPPLY ALTERNATIVES

dam is very small and, therefore, natural inflows to the reservoir do not contribute significantly to the yield of the project. A major advantage of the relatively small watershed area and low natural inflow is that spillway requirements for the dam are minimal and the potential for sediment accumulation in the reservoir is minimized. Additionally, the watershed area can be controlled to prevent undesirable land use.

Alternative 1 utilizes raw water pumped from the North Bosque River and storage in a nearby off-channel reservoir. The facilities required to develop this alternative include:

- channel dam on the North Bosque River;
- river intake and raw water pump station;
- raw water pipeline from the river to the off-channel reservoir;
- off-channel reservoir;
- surface water treatment plant;
- high service pump station; and
- distribution pipelines to Clifton and Meridian.

Alternative 1A includes an evaluation of diversion of raw water from the North Bosque River with storage in an off-channel reservoir located near Clifton. The diversion point for Alternative 1A is the site of the “Old Mill Dam” where the City of Clifton owns an existing municipal water right. Alternative 1B includes an evaluation of diversion of raw water from the North Bosque River with storage in an off-channel reservoir located near Meridian. The diversion point for Alternative 1B is located in the immediate vicinity of the off-channel reservoir site being evaluated.

4.3.1 Surface Water Availability and Firm Yield

Streamflow in the North Bosque River averages approximately 136,000 acre-feet per year as measured at the U.S. Geological Survey streamflow gaging station located in Clifton at the FM 219 bridge crossing. Although average annual streamflow in the North Bosque River is well in excess of the total regional water supply needs for Clifton and Meridian, there are times when flow in the river is very low. Flow in the North Bosque River is generally low during the summer months and has ceased flowing during several periods of the historical record. Due to these extended periods of extreme low flow that occur during drought conditions, storage is required in order to provide a consistent or “firm” surface water supply to the two cities.

SECTION 4 - SURFACE WATER SUPPLY ALTERNATIVES

There are several existing water rights on the North Bosque River both upstream and downstream of the proposed diversion points at Clifton (Alternative 1A) and Meridian (Alternative 1B). The largest water rights on the North Bosque River are associated with Lake Waco which has a total allocated storage capacity of 104,100 acre-feet. Lake Waco is owned by the City of Waco which has the right to divert 59,100 acre-feet per year for municipal and irrigation use. The water rights associated with Lake Waco are senior in priority to almost all other significant water rights on the North Bosque River upstream of Lake Waco. The seniority status of the Lake Waco water rights essentially means that flow in the North Bosque River must first satisfy Lake Waco's needs before flows may be diverted upstream.

The City of Clifton owns a water right on the North Bosque River and has the right to divert 600 acre-feet for municipal use. This water right is junior in priority to Lake Waco. However, terms included in the Lake Bosque "Windup Agreement" (See Section 1.1) allow Clifton and Meridian to apply for water rights up to an amount of 3,340 acre-feet per year from the Bosque River watershed which may be considered prior in right and superior to the rights in Lake Waco. The "Windup Agreement" would also allow for utilization of Clifton's existing water right under the subordination of the Lake Waco water rights as a part of the total 3,340 acre-feet per year. The terms of the "Windup Agreement" provide Clifton and Meridian access to water in the North Bosque River as a long-term water supply that was not available when water supply alternative studies were performed in the past.

Surface water availability in the North Bosque River was determined by updating the hydrologic modeling performed in support of the application for the water rights permit for the Lake Bosque project (HDR, 1988). Calculations of annual surface water available at Clifton and Meridian includes adjustments for full utilization of all water rights, except those associated with Lake Waco. Figure 4-2 shows the annual volume of surface water available at Clifton and Meridian for the period of 1946 through 1987. This period includes times of drought that were analyzed to size the water supply facilities required to provide a firm supply. The drought period of 1982 to 1984 is highlighted in Figure 4-3 as an example of a period when there was little or no flow in the North Bosque River for an extended period of time. This period ultimately was used to size the off-channel reservoirs at Clifton and Meridian.

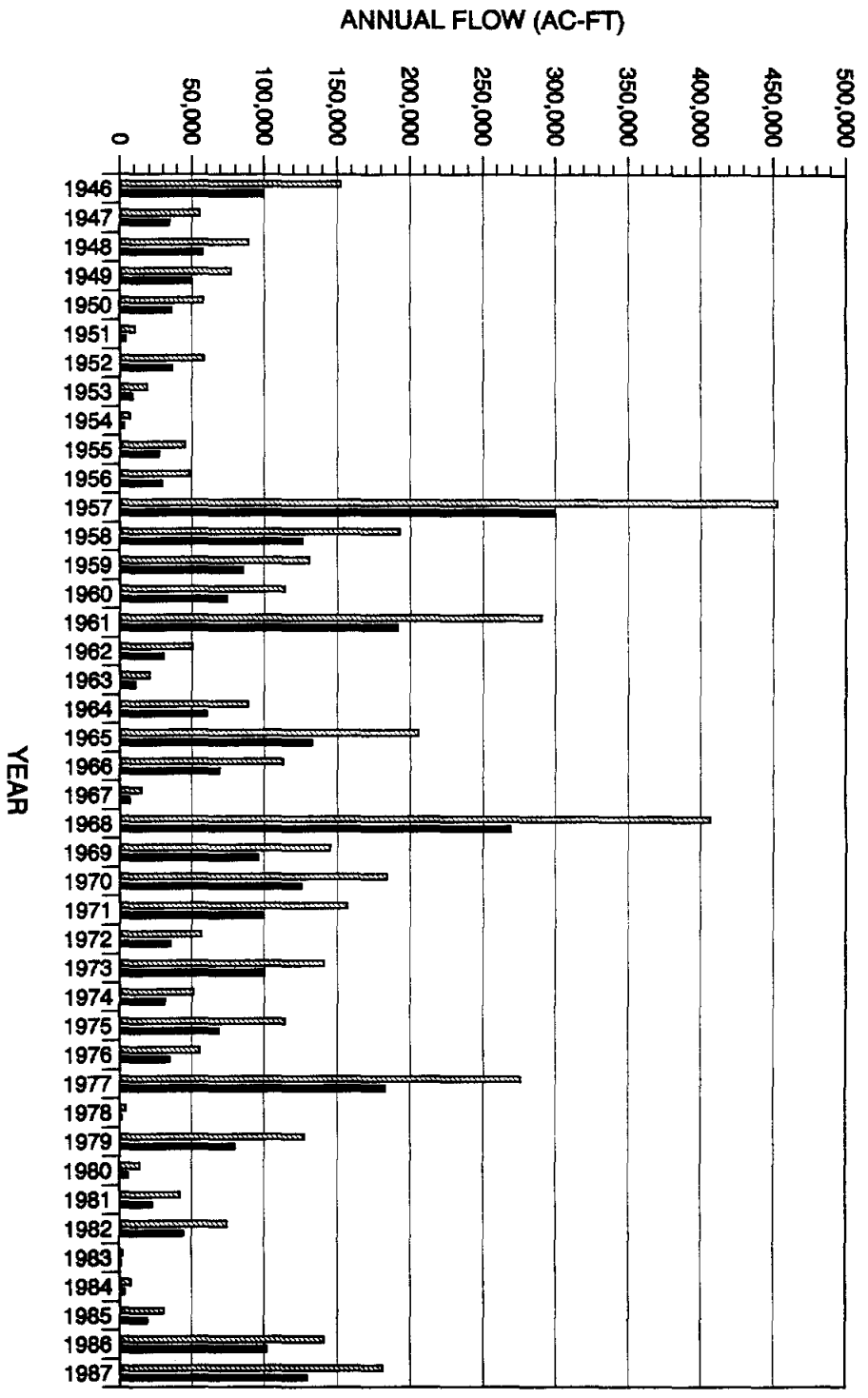

LEGEND

- ▨ NORTH BOSQUE RIVER AT CLIFTON
- NORTH BOSQUE RIVER AT MERIDIAN

NOTE: FLOWS ADJUSTED FOR FULL UTILIZATION OF UPSTREAM WATER RIGHTS AND IMPACTS OF UPSTREAM STRUCTURES.



HDR Engineering, Inc.

CITY OF CLIFTON AND CITY OF MERIDIAN
 REGIONAL WATER SUPPLY STUDY
**NORTH BOSQUE RIVER
 ANNUAL FLOW**

FIGURE 4-2

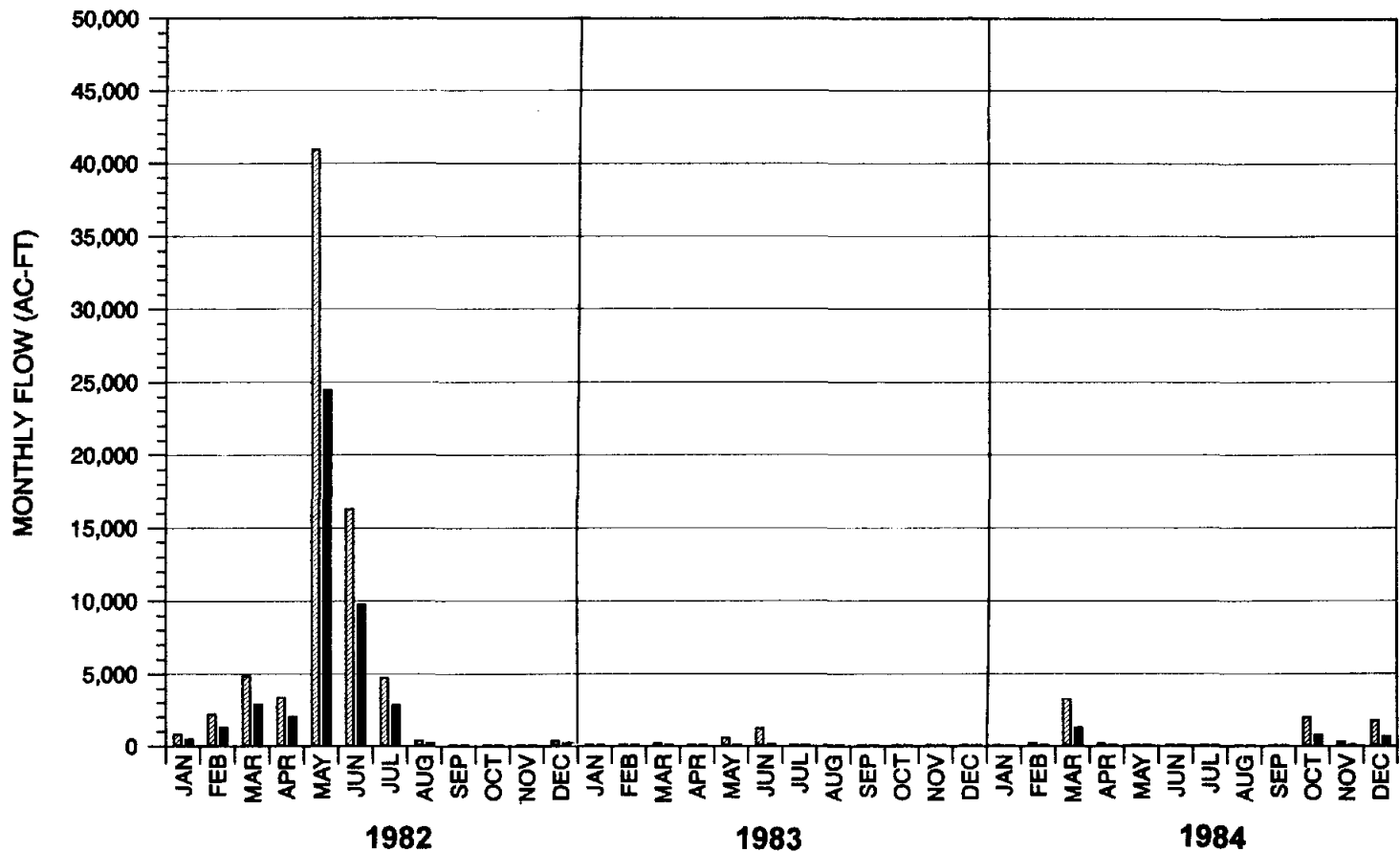

LEGEND

- ▨ NORTH BOSQUE RIVER AT CLIFTON
- NORTH BOSQUE RIVER AT MERIDIAN

NOTE: FLOWS ADJUSTED FOR FULL UTILIZATION OF UPSTREAM WATER RIGHTS AND IMPACTS OF UPSTREAM STRUCTURES.



HDR Engineering, Inc.

CITY OF CLIFTON AND CITY OF MERIDIAN REGIONAL WATER SUPPLY STUDY

NORTH BOSQUE RIVER MONTHLY FLOWS DURING DROUGHT PERIOD OF 1982 - 1984

FIGURE 4-3

SECTION 4 - SURFACE WATER SUPPLY ALTERNATIVES

A minimum instream flow of 6 cfs was maintained for fish and wildlife for new diversions from the North Bosque River at Meridian and Clifton. A minimum flow of 6 cfs was specified as part of the Lake Bosque water right permit, granted in 1991, and was used as a minimum threshold for this planning study. A detailed environmental study to assess actual instream flow needs would be required prior to implementation of a project.

The following factors were considered in evaluating sites near Clifton (Alternative 1A):

- Incorporation of the City of Clifton's existing water right;
- Minimum instream flow of 6 cfs was maintained for fish and wildlife for diversions in excess of Clifton's water right;
- Seven diversion rates (4 cfs to 25 cfs) were evaluated;
- Raw water pipelines ranging in size from 12 inches to 36 inches in diameter were evaluated.
- Off-channel storage to produce a firm yield of 1,297 ac-ft/yr was determined.

An optimization analysis was performed to determine the most economical combination of diversion rate and storage by calculating the cost associated with the required facilities. Three potential reservoir sites located near Clifton were evaluated (Sites C-1, C-2, and C-3 shown in Figure 4-1) and, for each of the sites evaluated, the optimum diversion rate to develop the required firm yield was found to be 9 cfs. The off-channel reservoir storage required at each of the three sites is summarized in Table 4-1.

Table 4-1 Alternative 1A Off-Channel Reservoir Storage Requirements		
Potential Site	Storage Required (ac-ft)	Surface Area (acres)
C-1	1,150	51
C-2	1,150	45
C-3	1,110	43

Note: Storage requirements based on diversion rate of 9 cfs from the North Bosque River at Clifton.

For Alternative 1B, factors similar to those listed for Alternative 1A were considered for sites near Meridian. A minimum flow of 6 cfs in the North Bosque River for fish and wildlife was considered for all diversions for Alternative 1A. Three potential reservoir sites located near Meridian were evaluated (Sites M-1, M-2, and M-3 shown in Figure 4-1). The optimum

SECTION 4 - SURFACE WATER SUPPLY ALTERNATIVES

diversion rate for all three sites was found to be 16 cfs. The off-channel reservoir storage for each of the three sites ranged from 2,900 ac-ft to 3,100 ac-ft as shown in Table 4-2.

Potential Site	Storage Required (ac-ft)	Surface Area (acres)
M-1	3,100	97
M-2	2,900	58
M-3	3,060	86

Note: Storage requirements based on diversion rate of 16 cfs from the North Bosque River near Meridian.

Significantly smaller volumes of storage are required for the Alternative 1A sites, as compared to the Alternative 1B sites, to produce a firm yield of 1,297 ac-ft/yr. Flow in the North Bosque River near Clifton is generally greater than the flow at Meridian due to the differences in watershed size at the two locations (968 square miles at Clifton compare to 710 square miles near Meridian). As a result, a diversion site near Clifton would allow for larger and more frequent diversions from the river, especially during times of drought (see Figure 4-3). In addition, Clifton's existing water right has no limitation on when flow may be diverted from the river other than diversions are subject to a maximum annual volume of 600 ac-ft for municipal use and a maximum diversion rate of 4 cfs. Utilization of Clifton's existing water right at Clifton, where greater flows exist, reduces the reliance on storage to provide a firm supply as compared to Alternative 1B (near Meridian). For sites near Meridian, a new water right permit would be required which would be subject to environmental criteria that would place limitations on when flow could be pumped from the river. These conditions for a new water right permit, along with lower and less frequent flow at Meridian, increases the amount of storage required for Alternative 1B to develop a firm yield of 1,297 ac-ft/yr during times of drought.

4.3.2 North Bosque River Water Quality

Water quality generally dictates the type of treatment processes required to meet the state and federally mandated drinking water standards and the quality of a proposed surface water supply source can have significant effects on the feasibility of its use. Surface water of unusually

SECTION 4 - SURFACE WATER SUPPLY ALTERNATIVES

low quality may be uneconomical to treat, whereas high quality groundwater, such as Clifton and Meridian's current supply, may require very little treatment prior to distribution.

The quality of drinking water consumed in Texas is governed by both federal and state regulations. The Safe Drinking Water Act (SDWA), and its 1986 amendments, make up the federal rules governing drinking water. The Texas Natural Resource Conservation Commission (TNRCC) is charged with ensuring compliance within the state to the SDWA federal rules. To accomplish this, the TNRCC has published "Drinking Water Standards Governing Water Quality and Reporting for Public Water Supply Systems" which outline the state's regulations. The SDWA and the TNRCC Drinking Water Standards set forth standards for finished water quality and treatment procedures for drinking water in Texas. The regulations are very comprehensive and address approximately 125 separate constituents. The primary regulated constituents include coliform bacteria (and indicator of disease causing microbiological contaminants), organic and inorganic constituents (decayed matter, metals, pesticides), radionuclides (radioactive materials), disinfection by-products (compounds resulting from the chemical reaction of organic material and a disinfectant such as chlorine), and turbidity (cloudiness). Secondary limits have also been established for parameters such as odor, color, pH, sulfates, chlorides, and total dissolved solids. The secondary limits do not affect existing water supplies unless an alternate source of better quality is available. However, new water supplies will be most likely required to comply with both sets of standards.

Table 4-3 presents a summary of the available water quality data for the North Bosque River, the applicable drinking water standards, and water quality data for the current groundwater supply. Although the data is not representative of all 125 regulated constituents, the parameters listed are key items which give an indication of the overall water quality and the levels of treatment which will be required. As shown in Table 4-3, water quality in the North Bosque River is generally within the applicable drinking water standards. The water quality of the North Bosque River at Meridian is expected to be similar to the water quality at Clifton though a slight difference may be noticed due to the influence of Meridian Creek, which enters the North Bosque River just upstream of Clifton. Meridian Creek contains less organic material and is less turbid, and the quality of water in the North Bosque River at Clifton below the confluence may be slightly improved when compared to the water quality near Meridian. However, with the

SECTION 4 - SURFACE WATER SUPPLY ALTERNATIVES

Table 4-3 Alternative 1 Available Water Quality Data¹				
Constituent	Drinking Water Standards	Ground Water	North Bosque River	Meridian Creek
Total Dissolved Solids, mg/l ¹	500	450-500	200-300	N/A
Total Hardness, mg/l	---	10-70	N/A	N/A
Total Alkalinity, mg/l ³	120	300-350	175-250	150-160
pH	>7.0	7.0-8.5	7.8-8.3	8.0-8.1
Total Organic Carbon ³	4-8	N/A	4.0-5.0	2.0-3.0
Chlorides, mg/l	300	20-30	50-65	15-20
Sulfates, mg/l ⁴	300	50-55	50-60	30-35
Total Suspended Solids, mg/l	---	N/A	30-40	5-20

Note:

- 1) Data taken from USGS stream gage data, Intensive Survey of North Bosque River by Brazos River Authority, and Texas Natural Resource Conservation Commission Water Analysis.
- 2) EPA/World Health Organization recommended standard. TNRCC Drinking Water Secondary Standard is 1000 mg/l which is enforced as a primary standard for new water supplies.
- 3) Trigger levels for total organic carbon removal in currently proposed enhanced surface water treatment rule for total alkalinity >120 mg/l and total organic carbon in the range of 4 to 8 would require 25% removal of total organic carbon.
- 4) EPA is currently developing a sulfate rule with a proposed primary standard of 500 mg/l.

detention time that occurs in the proposed off-channel reservoir, the difference in water quality delivered to the water treatment plant is expected to be minor.

Total dissolved solids (TDS) and total alkalinity are indicators of the amount of dissolved compounds in the water. Both constituents in the North Bosque River are below the drinking water standards and should not present any special treatment problems. Water hardness is also related to dissolved solids and is typically recognized by the user as the water's reaction with soap. Although data is not available for hardness of water in the river, the other parameters listed indicate that the hardness can be expected to be in the range of 150 to 250 milligrams per liter. This surface water source is much harder than the current groundwater supply and would be characterized as moderately hard. Removal of hardness can be achieved by a water softening process. However, water softening is usually quite expensive and generally is not considered economically feasible for waters under 150 milligrams per liter. Given the hardness levels in the North Bosque River, it appears that softening probably would not be economically feasible. If the surface water is not softened, a change in the reaction of the water with soap and

SECTION 4 - SURFACE WATER SUPPLY ALTERNATIVES

accumulations of calcium carbonate in pipes or on plumbing surfaces may be noticed. However, accumulations should be able to be controlled by stabilization of the water during the treatment process. Blending of treated surface water and groundwater appears to be feasible. The differences in hardness may cause a calcium carbonate precipitate in the blending tank, however, modifications of the water chemistry of the surface water during the treatment process should control precipitates.

Chlorides and sulfates are commonly found in many raw water sources. In high levels chlorides can give water a salty taste and sulfates can have a laxative affect and contribute to odors. Neither constituent appears to be near a level to create a problem.

The total suspended solids level indicates that the water in the North Bosque River is fairly turbid. While not unusually high, there is a significant amount of organic (algae) and inorganic (sediment) suspended material in the water.

The pH of the water and the total organic carbon (TOC) levels indicate that the North Bosque River contains significant biological material. Organic matter in the water can contribute to the formation of several by-products when reacted with disinfectants such as chlorine. These by-products, called trihalomethanes, have been shown to be carcinogens when ingested at high levels. Recent water quality surveys performed as part of the Brazos River Authority's "Intensive Survey of the North Bosque River" (BRA, 1994) have indicated high biological growth with large amounts of algae upstream of Meridian. Organics are common in many of the surface water sources across the state, however they merit special attention since new regulations are now being developed by the federal government which will extend the trihalomethane regulations to all water supply systems, regardless of size. Organic levels reported near Clifton and Meridian in the North Bosque River, however, are not unusually high when compared to other surface water sources around the state and do not appear prohibitive. The proposed regulatory levels should be attainable with proper consideration in the design of the water treatment process.

The organic material and algae in the North Bosque River water will also have the potential to develop differing tastes and, at times, odors. Several specific algae types can produce incidences of discernible tastes and odors, particularly in the spring and fall. If indeed tastes and odors prove to be noticeable, several treatment schemes can be used to reduce the

SECTION 4 - SURFACE WATER SUPPLY ALTERNATIVES

problem. It is likely that a difference in taste will be noticed with a new surface water supply due to the difference in the water chemistry.

An additional water quality concern which should be taken into account is the presence of two particular disease-causing pathogens, *Giardia lamblia* and *Cryptosporidium parvum*. These pathogens are very small and exist in the form of hard-shell cysts which are resistant to disinfection chemicals. Their presence is not uncommon as they are found in over 90 percent of the surface water sources in the United States. Several large outbreaks of waterborne disease have occurred in recent years due to *Cryptosporidium* and *Giardia*, and the federal government is in the process of developing new regulations to ensure the inactivation and/or removal by treatment processes. Both of the microorganisms are associated with human and animal waste and are found at differing levels in most surface waters in the country. Since the North Bosque River watershed contains a heavy concentration of dairy and cattle operations upstream of Clifton and Meridian, the possibility exists for higher than normal levels of pathogens. The recent study conducted by the Brazos River Authority (BRA, 1994) included sampling for *Giardia* and *Cryptosporidium*. The study found high concentrations of both pathogens near Stephenville, but low concentrations were found near Clifton. It should be noted that the test methods currently available for *Cryptosporidium* limit the results since a very low percentage of the organisms are actually recovered and counted by the test. In addition, the current test methods cannot determine if the organisms are still active.

4.3.3 Water Treatment

Available water quality data from the North Bosque River indicates that conventional water treatment practices should produce potable water meeting both federal and state requirements. Conventional water treatment consists of disinfection, coagulation/flocculation, sedimentation, and filtration. Disinfection is accomplished by the addition of a chemical compound, such as chlorine, to inactivate or kill microorganisms in the water. Coagulation/flocculation is a two step process which uses a chemical coagulant, such as aluminum sulfate, to attract the very fine suspended particles to each other and accumulate them into large, heavier particles which settle to the bottom of a tank in the sedimentation step. The settled water is then passed through a granular filter for final polishing.

SECTION 4 - SURFACE WATER SUPPLY ALTERNATIVES

For Alternative 1, the water treatment plant will benefit from the storage of raw water in the off-channel reservoir. The relatively long detention time in the reservoir will allow sedimentation to occur prior to treatment. This pre-sedimentation effect is expected to remove a large percentage of the suspended solids and should provide a relatively consistent, high quality feedwater to the water treatment plant. The off-channel reservoir also provides operational flexibility since water will not have to be diverted from the North Bosque River when the water quality is poor.

Since the raw water feeding the treatment plant is expected to be relatively low in suspended matter, it will likely be possible to utilize a package-type conventional water treatment process. These systems are pre-packaged steel tank treatment units which are shop fabricated and delivered to the site. The advantage of the package units is that they are much lower in cost and require much less land and concrete tankage than conventional treatment plants. In addition, package-type units are easily automated so the plant can operate unattended, reducing staff requirements. Automation systems are used extensively and can be designed to monitor water quality, shutdown the plant, and sound alarms in the event of a problem.

A schematic drawing of the proposed treatment process is shown in Figure 4-4 and a conceptual water treatment plant layout is shown in Figure 4-5. The design of the system utilizes a package treatment unit consisting of an adsorption clarifier and a polishing filter. The adsorption clarifier effectively accomplishes the coagulation and flocculation step and eliminates the need for further sedimentation. This type of process is currently considered an “innovative technology” by the TNRCC and requires field testing prior to approval. However, the process is widely accepted and has been successfully installed at several locations throughout the state.

4.3.4 Dams and Reservoirs

Three potential off-channel dam and reservoir sites were selected for evaluation near Clifton for Alternative 1A and three potential sites were selected for evaluation near Meridian for Alternative 1B (See Figure 4-1). The selection of these sites was based on proximity to existing and projected water demands, topographic suitability for construction, proximity to potential diversion locations, and potential relocations required. U.S. Geological Survey 7.5 minute series topographic maps were utilized for the selection of the potential dam sites and for developing

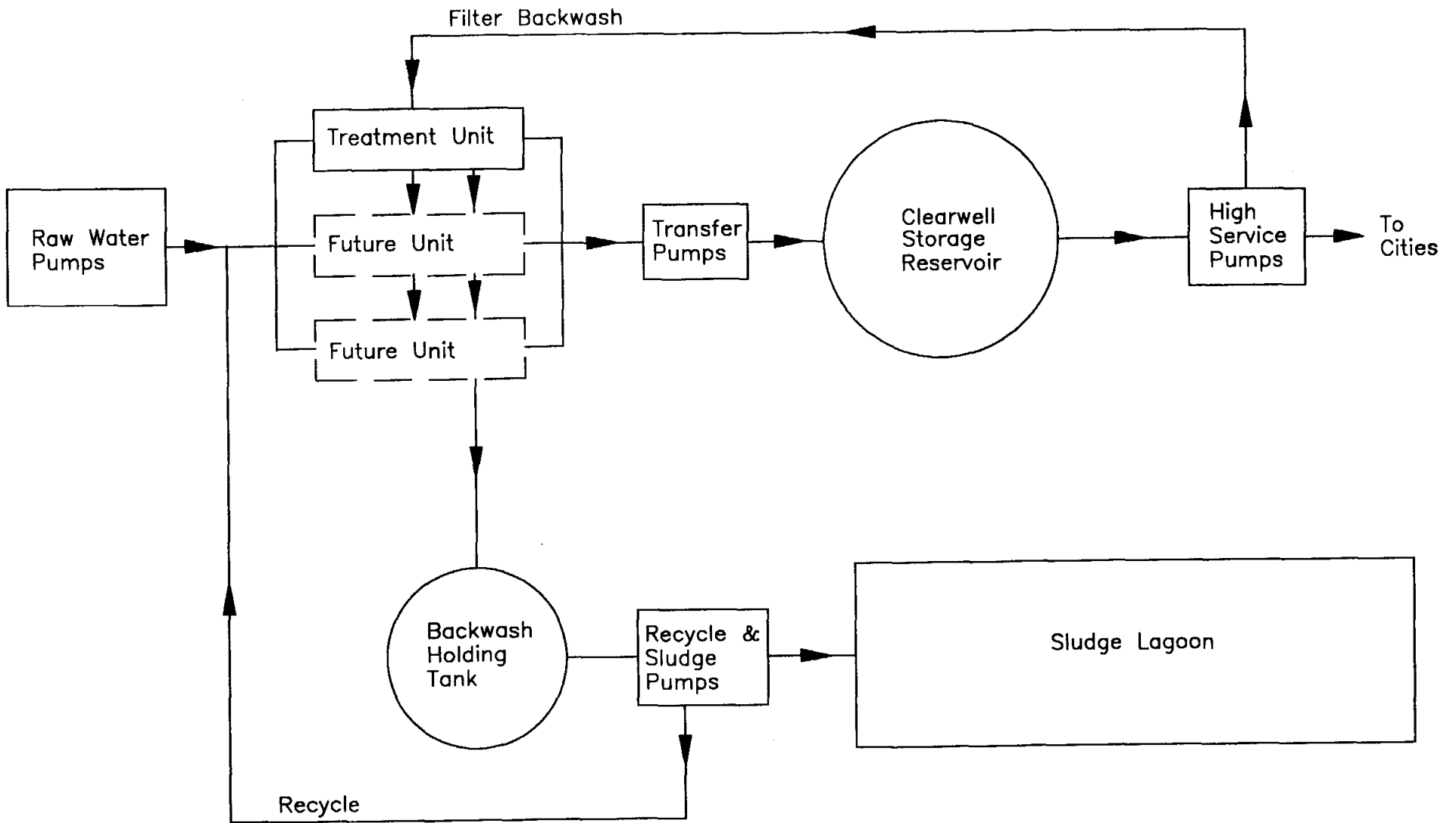

CITY OF CLIFTON AND CITY OF MERIDIAN
REGIONAL WATER SUPPLY STUDY

**REGIONAL WATER TREATMENT PLANT
PROCESS SCHEMATIC**



HDR Engineering, Inc.

FIGURE 4-4

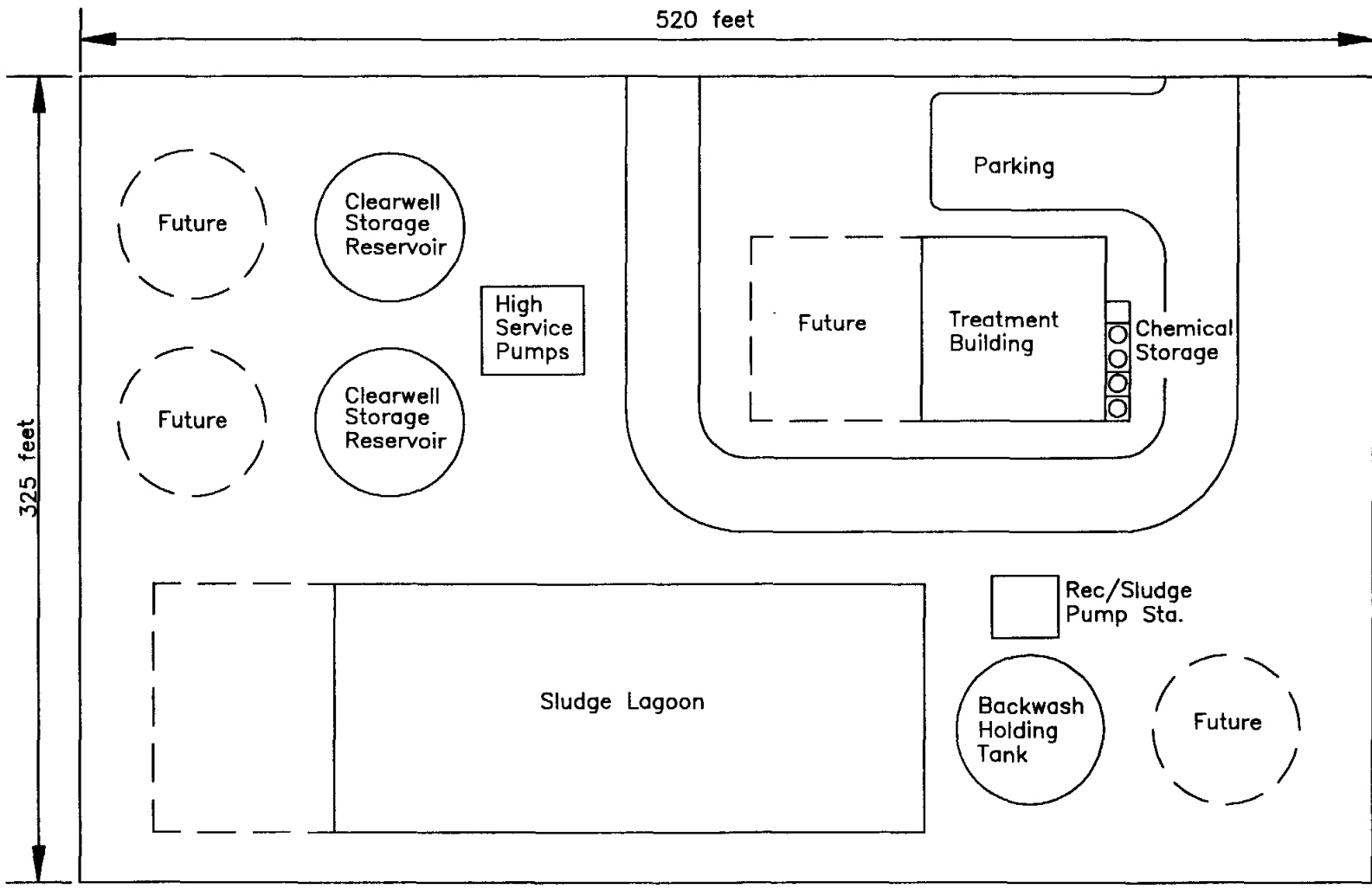

NOT TO SCALE



HDR Engineering, Inc.

CITY OF CLIFTON AND CITY OF MERIDIAN
REGIONAL WATER SUPPLY STUDY

**REGIONAL WATER TREATMENT PLANT
CONCEPTUAL SITE LAYOUT**

FIGURE 4-5

SECTION 4 - SURFACE WATER SUPPLY ALTERNATIVES

elevation-area-capacity relationships for the reservoirs. A cursory site reconnaissance was performed at each of the potential sites where property access was available (C-1, C-3, M-1, M-2, M-3) and no "fatal" flaws that would prohibit construction were observed. Large existing stock tanks contained within some of the sites and other existing lakes located nearby provide a good demonstration of the water retention capability of the geologic formation in the area.

The topographic and geologic conditions of the dam sites and surrounding area are conducive to earth fill, as opposed to concrete, dam construction. However, suitable clay fill to construct the core and seepage cutoff for the dam does not appear to be available within the immediate vicinity of the potential off-channel reservoir sites. This material would likely need to be hauled to the site from a borrow area located within the bottomland of the North Bosque River valley. Random earth fill for the outer shells of the dam would be obtained from borrow areas within or nearby the reservoir and from excavation for the seepage cutoff trench. It is anticipated that sand drain and rock riprap materials would need to be imported from a commercial quarry operation(s). The earth dam cross section presented is conceptual and would be refined during the design phase following thorough geologic and geotechnical investigations of the dam site and potential construction material borrow areas. A typical earth dam cross section for an off-channel dam is shown in Figure 4-6.

A typical profile for an off-channel dam site is shown in Figure 4-7. Because of the small drainage area above the dam, the normal pool elevation of the reservoir was established four feet below the top of the dam. This distance, known as freeboard, provides sufficient flood storage to safely pass major rainfall events without overtopping dam. A separate overflow chamber in the intake tower and a 36-inch outlet pipe through the base of the dam would serve as the spillway. Water would be delivered by gravity from the reservoir to the treatment facility using a second pipe (14-inch diameter) through the base of the dam connected to a chamber in the intake tower. The design of the intake tower would allow for withdrawal of water from selected depths in the reservoir to obtain the best quality water for treatment.

For Alternative 1A, the estimated construction cost for a dam at site C-3 is slightly lower than at sites C-1 and C-2. The estimated costs for sites C-1 and C-2 were essentially the same. However, because site C-1 is closer to both the proposed river diversion location and water demands, the pipelines required to deliver water to and from reservoir site C-1 would be

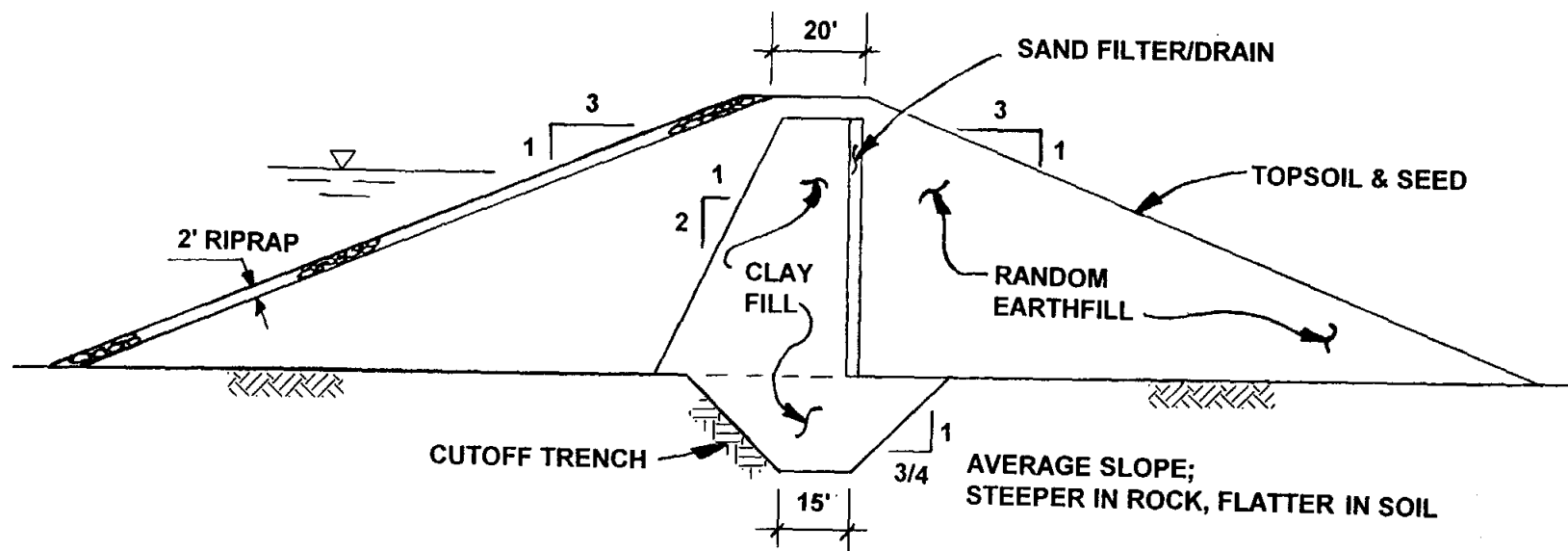

NOT TO SCALE



HDR Engineering, Inc.

CITY OF CLIFTON AND CITY OF MERIDIAN
REGIONAL WATER SUPPLY STUDY

TYPICAL SECTION
EARTH DAM

FIGURE 4-6

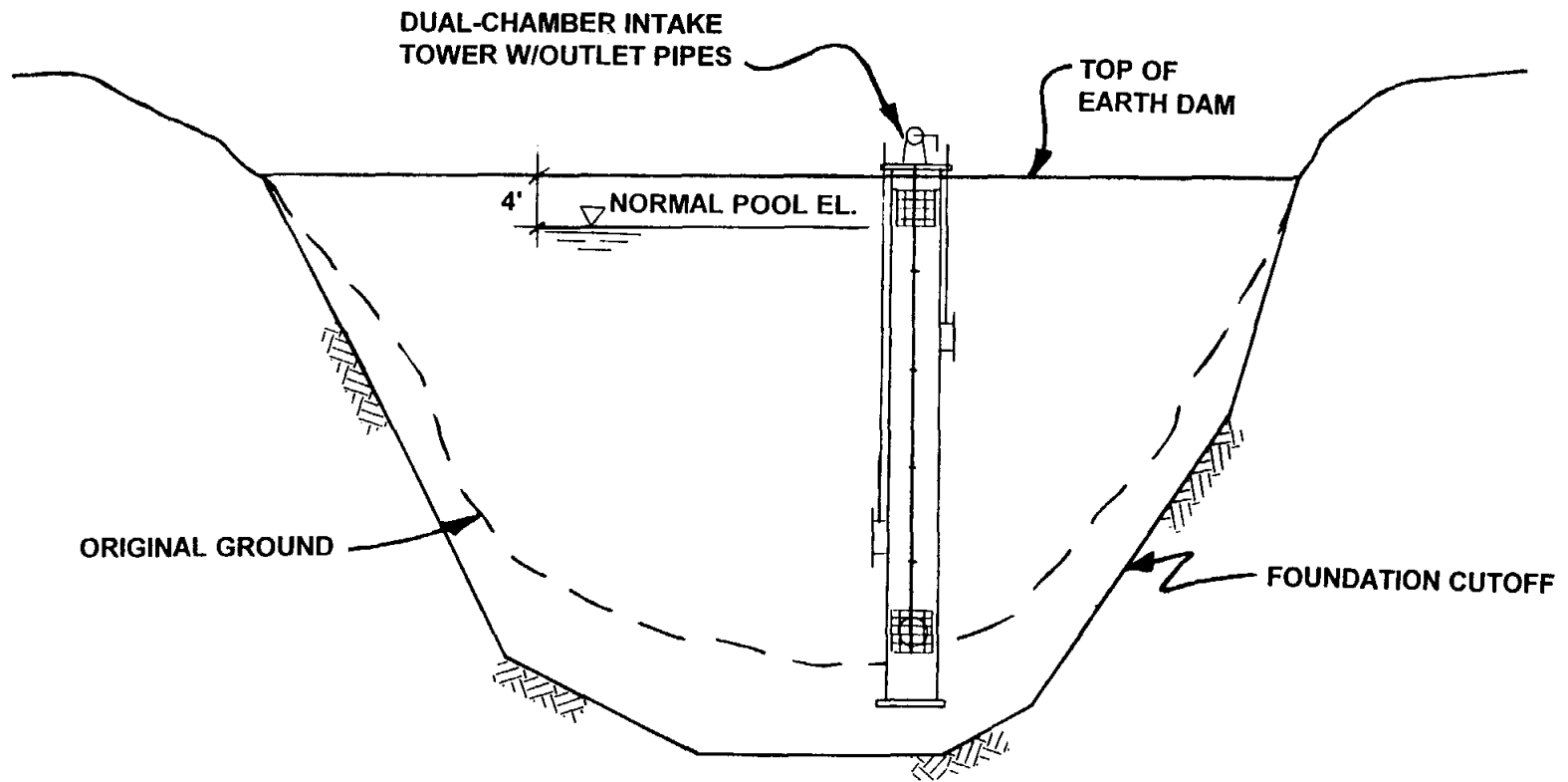

NOT TO SCALE



HDR Engineering, Inc.

CITY OF CLIFTON AND CITY OF MERIDIAN
REGIONAL WATER SUPPLY STUDY

TYPICAL PROFILE
OFF-CHANNEL DAM

FIGURE 4-7

SECTION 4 - SURFACE WATER SUPPLY ALTERNATIVES

significantly shorter than for sites C-2 and C-3. The resulting savings in pipeline costs more than offset the slightly higher dam cost at site C-1. Therefore, site C-1 was selected as the recommended off-channel dam and reservoir site for Alternative 1A. The proposed configuration of site C-1 and associated facilities are shown in Figure 4-8. For this site, a dam approximately 60 feet high and 1,600 feet long is required to impound the required storage volume of 1,150 ac-ft. The reservoir area at the normal pool elevation would be approximately 52 acres.

For Alternative 1B, the cost for a dam at sites M-1 and M-3 is essentially the same, while cost for a dam at site M-2 is significantly higher. Site M-1 was selected as the preferred off-channel dam and reservoir site as shown in Figure 4-9, since the costs associated with the required pipelines and pump stations were less than for site M-3. For site M-1, a dam approximately 80 feet high and 1,200 feet long is required to impound the required storage volume of 3,100 ac-ft. The reservoir area at the normal pool elevation would be approximately 97 acres.

The proposed diversion location for Alternative 1A is from the North Bosque River at Clifton at the site of the "Old Mill Dam" where Clifton's existing municipal water right is located. The proposed diversion location for Alternative 1B is from the North Bosque River near Meridian, located just east of Highway 6 near the selected site (M-1). A new channel dam would need to be constructed at either site to create a permanent, reliable pool in the North Bosque River from which water can be pumped to the off-channel storage reservoir. A dam across the North Bosque River must be a massive structure capable of withstanding major floods and the test of time, as evidenced by remnants of the "Old Mill Dam." A conceptual design for a channel dam constructed using roller compacted concrete (RCC), which is the latest technology in the design and construction of concrete dams, is shown in Figure 4-10. A major advantage of RCC is rapid construction, which is particularly important in this application since cost savings could be realized by constructing the dam during the summer months when there is less flow in the river. A stilling basin would be provided below the dam to dissipate energy, prevent erosion, and eliminate undermining of the downstream toe of the dam.

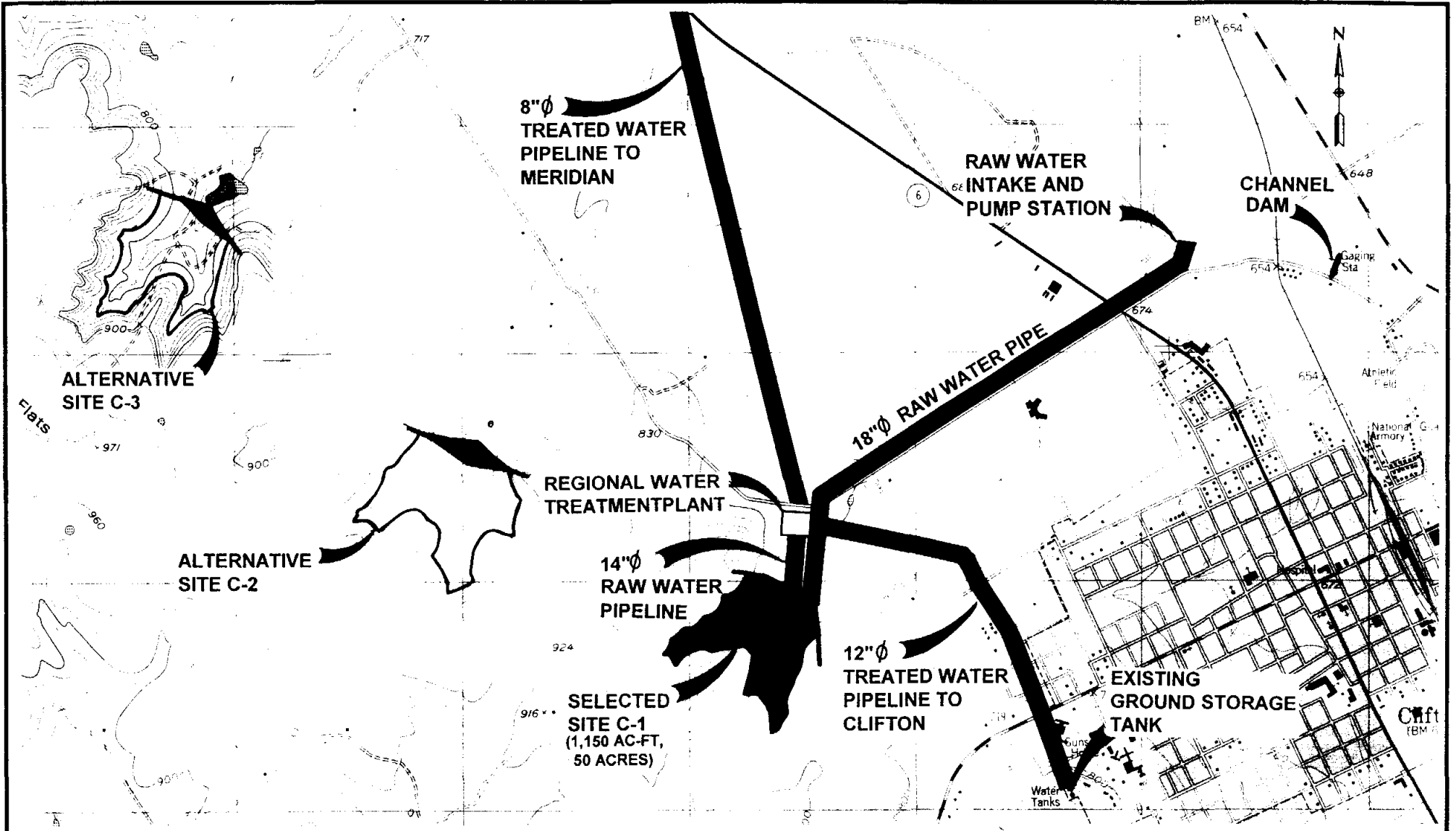

SCALE 1" = 2000'

CITY OF CLIFTON AND CITY OF MERIDIAN
REGIONAL WATER SUPPLY STUDY



HDR Engineering, Inc.

**ALTERNATIVE 1A
OFF-CHANNEL RESERVOIR
NEAR CLIFTON**

FIGURE 4-8

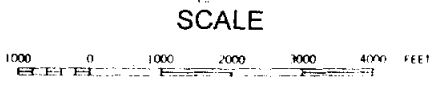
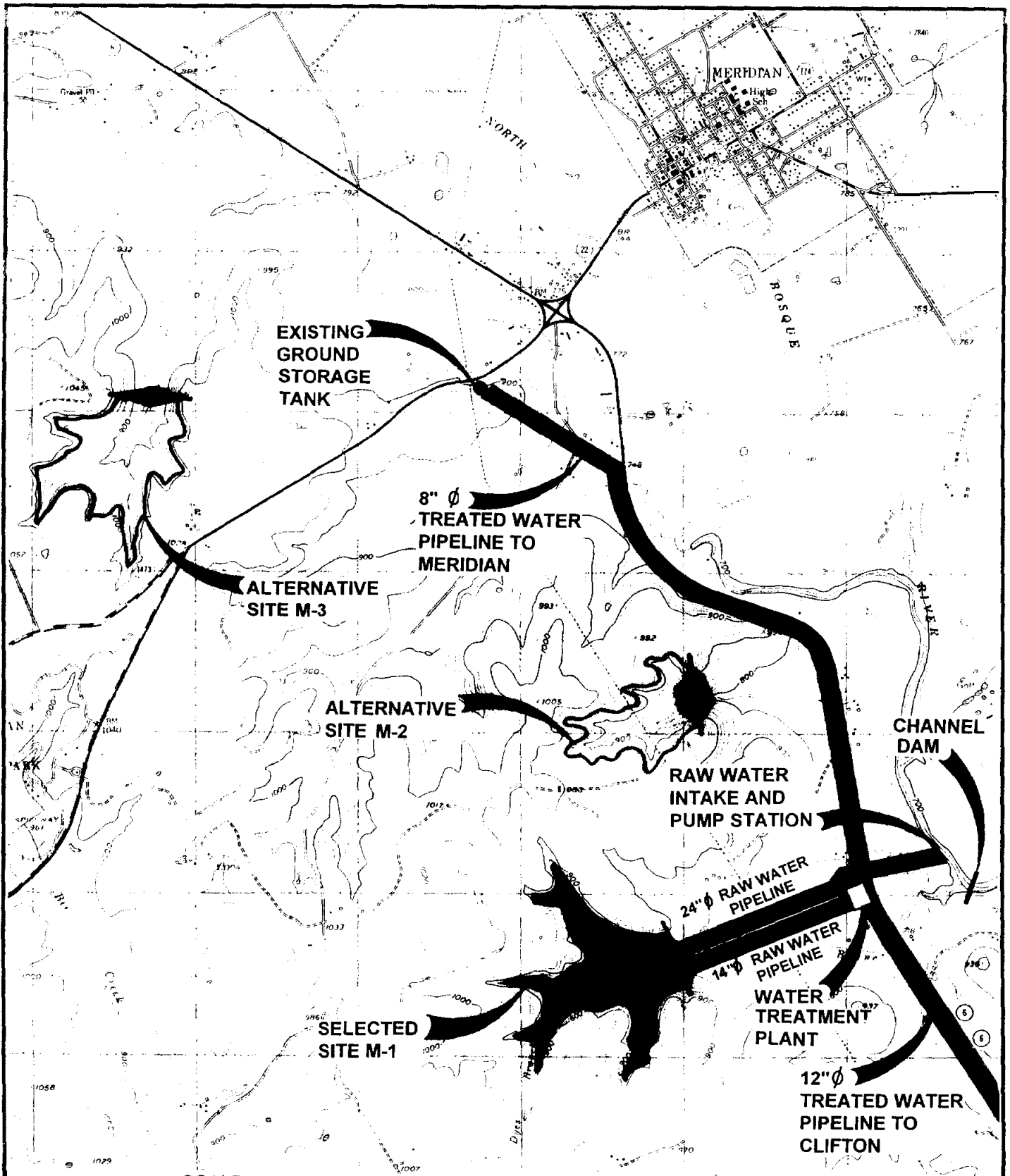

CITY OF CLIFTON AND CITY OF MERIDIAN
REGIONAL WATER SUPPLY STUDY

**ALTERNATIVE 1B
OFF-CHANNEL RESERVOIR
NEAR MERIDIAN**

FIGURE 4-9



HDR Engineering, Inc.

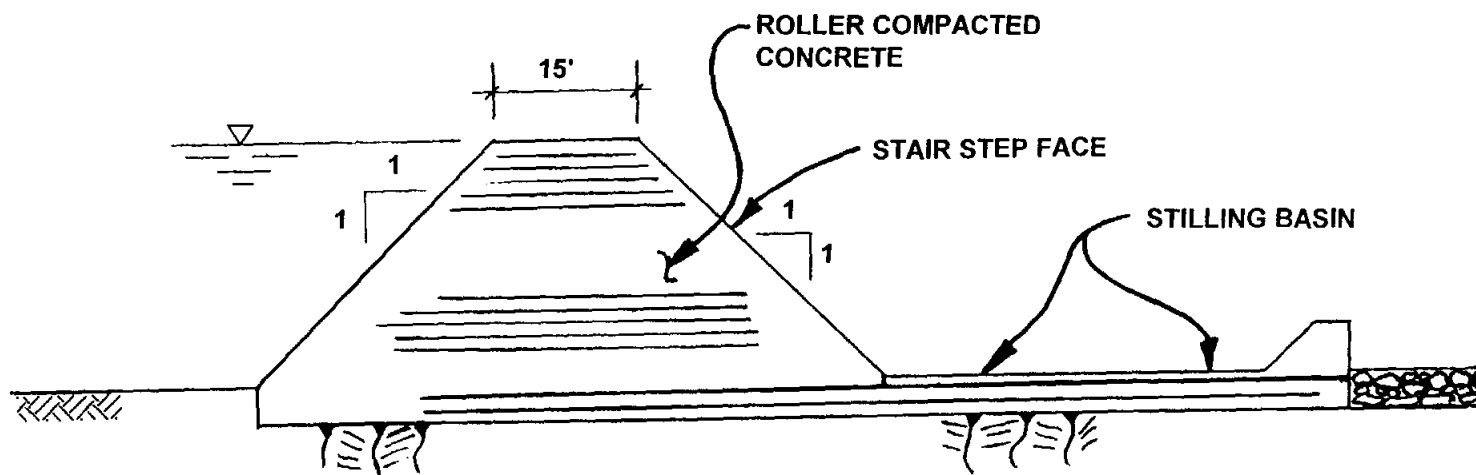

NOT TO SCALE



HDR Engineering, Inc.

CITY OF CLIFTON AND CITY OF MERIDIAN
REGIONAL WATER SUPPLY STUDY

CHANNEL DAM
BOSQUE RIVER

FIGURE 4-10

SECTION 4 - SURFACE WATER SUPPLY ALTERNATIVES

4.3.5 Regional Distribution System

The distribution system necessary to deliver the new surface water supply to Clifton and Meridian is a common element for each alternative. The distribution pipelines and pump stations to each city were sized to deliver the projected year 2050 peak day demands at a velocity of approximately five feet per second. The pipelines were assumed to be located within a 20-foot easement width. The selected delivery points provide treated water to each city at existing ground storage tanks. Figure 4-11 and Figure 4-12 show the proposed regional distribution systems for Alternative 1A and Alternative 1B, respectively. The pipeline routes for the two systems are similar, following Highway 6 to the delivery points. The pipeline to Clifton would be 12 inches in diameter, while the pipeline to Meridian would be 8 inches in diameter. Pipelines delivering the combined peak day demand of both cities would be 14 inches in diameter. The primary delivery points for Clifton and Meridian are located approximately 11 miles apart, resulting in significant costs for water transmission.

4.3.6 Project Cost Estimate

Cost estimates for Alternative 1A and Alternative 1B were computed in terms of capital cost, annual debt service, and operation and maintenance cost including power. The cost estimates assume the facilities would be sized to meet the 2050 average and peak day demands of both cities. Table 4-4 and Table 4-5 provide a comparison of the project cost estimates for Alternative 1A and Alternative 1B, respectively. The total capital cost for Alternative 1A was estimated to be \$9,043,000 and the total capital cost for Alternative 1B was estimated to be \$11,345,000. The higher capital cost for Alternative 1B is attributed to the larger storage volume required for the off-channel reservoir and greater diversion rate to meet the required 2050 firm yield. The annual O&M costs were essentially the same for Alternative 1A and Alternative 1B. Alternative 1B had lower O&M costs for the raw water intake/pump station due to the shorter distance from the river to the off-channel reservoir, however the larger distance to pump water to Clifton, the larger of the two demands, produced higher pumping costs which offset the savings achieved by the river intake/pump station.

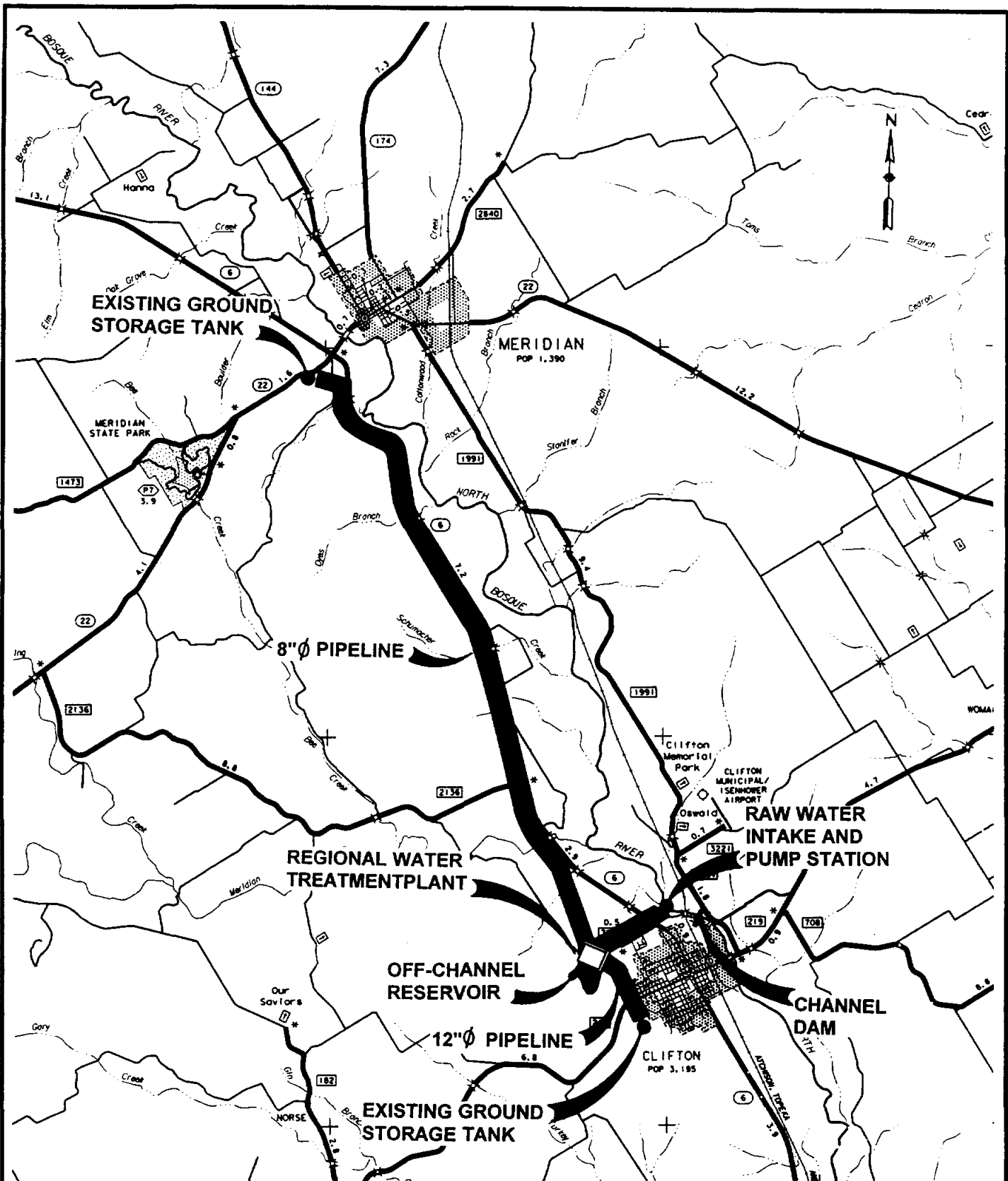

CITY OF CLIFTON AND CITY OF MERIDIAN
REGIONAL WATER SUPPLY STUDY

**ALTERNATIVE 1A
REGIONAL SYSTEM**



HDR Engineering, Inc.

FIGURE 4-11

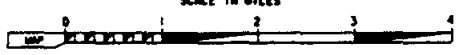
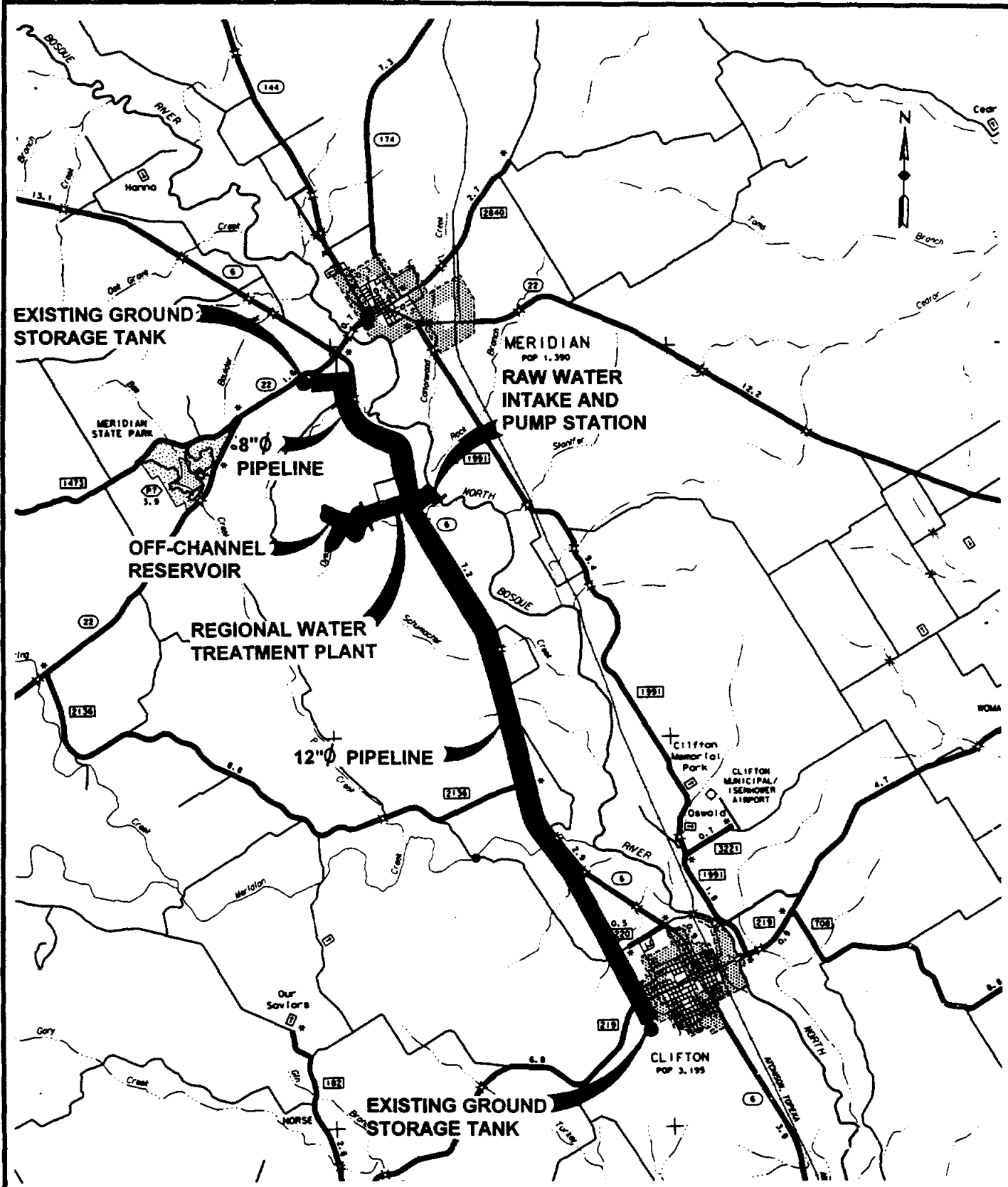

CITY OF CLIFTON AND CITY OF MERIDIAN
REGIONAL WATER SUPPLY STUDY

ALTERNATIVE 1B
REGIONAL SYSTEM



HDR Engineering, Inc.

FIGURE 4-12

SECTION 4 - SURFACE WATER SUPPLY ALTERNATIVES

**Table 4-4
Alternative 1A - Project Cost Estimate
Diversion from North Bosque River with Off-Channel Reservoir near Clifton**

Facility	Capital Cost ¹	Annual Debt Service ²	O&M Cost	Total Annual Cost
Raw Water Pumping Facilities ³	\$2,091,000	\$179,400	\$65,000	\$244,400
Off-Channel Dam & Reservoir ⁴	\$1,977,000	\$169,700	\$15,000	\$184,700
Water Treatment Plant ⁵	\$3,238,000	\$277,900	\$185,000	\$462,900
Regional Distribution System ⁶	\$1,737,000	\$149,100	\$35,000	\$184,100
Total	\$9,043,000	\$776,100	\$300,000	\$1,076,100
City of Clifton (70%) ⁷	\$6,330,000	\$543,300	\$210,000	\$753,300
City of Meridian (30%) ⁷	\$2,713,000	\$232,800	\$90,000	\$322,800

Notes:
 1) Includes 10% for construction contingencies and 15% for engineering, surveying, permitting, legal, and financial services.
 2) Annual debt service based on an interest rate of 7.0% over 25 years.
 3) Raw water pumping facilities include a channel dam, raw water intake and pump station (9 cfs), and 9,300 ft. raw water pipeline to the off-channel reservoir (18" diameter)
 4) Off-channel reservoir includes the dam, spillway and intake tower, and 52 acres of land assumed to cost \$700 per acre.
 5) Water treatment plant consists of a 3 mgd package treatment plant, sitework, and access road.
 6) Regional distribution system includes a high service pump station and 11.3 miles of pipelines to deliver treated water for peak day demands to Clifton and Meridian.
 7) Proportion between Clifton and Meridian based on average annual water use.

**Table 4-5
Alternative 1B- Project Cost Estimate
Diversion from North Bosque River with Off-Channel Reservoir near Meridian**

Facility	Capital Cost ¹	Annual Debt Service ²	O&M Cost	Total Annual Cost
Raw Water Pumping Facilities ³	\$2,302,000	\$197,600	\$56,000	\$253,600
Off-Channel Dam & Reservoir ⁴	\$3,427,000	\$294,100	\$15,000	\$309,100
Water Treatment Plant ⁵	\$3,238,000	\$277,900	\$185,000	\$462,900
Regional Distribution System ⁶	\$2,378,000	\$204,000	\$44,000	\$248,000
Total	\$11,345,000	\$973,600	\$300,000	\$1,273,600
City of Clifton (70%) ⁷	\$7,942,000	\$681,500	\$210,000	\$891,500
City of Meridian (30%) ⁷	\$3,403,000	\$292,100	\$90,000	\$382,100

Notes:
 1) Includes 10% for construction contingencies and 15% for engineering, surveying, permitting, legal, and financial services.
 2) Annual debt service based on an interest rate of 7.0% over 25 years.
 3) Raw water pumping facilities include a channel dam, raw water intake and pump station (16 cfs) and 6,000 ft. raw water pipeline to the off-channel reservoir (24" diameter)
 4) Off-channel reservoir includes the dam, spillway and intake tower, and 97 acres of land assumed to cost \$700 per acre.
 5) Water treatment plant consists of a 3 mgd package treatment plant, sitework, and access road.
 6) Regional distribution system includes a high service pump station and 11.8 miles of pipelines to deliver treated water for peak day demands to Clifton and Meridian.
 7) Proportion between Clifton and Meridian based on average annual water use.

SECTION 4 - SURFACE WATER SUPPLY ALTERNATIVES

4.4 Alternative 2 - Reservoir on Meridian Creek or Major Tributary

Alternative 2 consists of a reservoir on Meridian Creek or major tributary to Meridian Creek that would store runoff from the upstream watershed for use as a surface water supply by Clifton and Meridian. Meridian Creek is a major tributary to the North Bosque River and generally flows eastward towards its confluence with the North Bosque River about two miles north of Clifton. Several smaller streams contribute to Meridian Creek from the northwest including Bee Creek, Spring Creek, and Mustang Creek (Refer to Figure 4-1). Streamflow in Meridian Creek would not provide a continuous supply of water due to drought periods that occur periodically. Based on records for the North Bosque River watershed at Clifton, flow in Meridian Creek ceases during most of the drought periods that have occurred. Therefore, in order to provide a dependable and firm supply of water, storage must be considered to meet the water supply demands of Clifton and Meridian. Small dams on Meridian Creek were evaluated as a means of providing storage of the natural runoff. The facilities required to develop this alternative include:

- dam on Meridian Creek or major tributary to Meridian Creek;
- raw water intake and pump station;
- raw water pipeline from proposed reservoir to water treatment plant;
- surface water treatment plant;
- high service pump station; and
- distribution pipelines to Clifton and Meridian.

Three potential dam and reservoir sites were initially evaluated for Alternative 2 (see sites MC-1, MC-2, and MC-3 in Figure 4-1). However, after firm yield and preliminary cost analyses were performed at the three sites, two additional sites, shown as MC-4 and MC-5, were also evaluated as part of Alternative 2.

4.4.1 Surface Water Availability and Firm Yield

Historical streamflow records do not exist for Meridian Creek other than a few isolated measurements. As a result, estimates of streamflow were based on available gaged data for the North Bosque River upstream and downstream of the Meridian Creek confluence. Monthly streamflow estimates for each of the five potential dam sites on Meridian Creek and its

SECTION 4 - SURFACE WATER SUPPLY ALTERNATIVES

tributaries were developed by calculating the prorata share of natural runoff between the Clifton and Hico gaging stations.

Existing water rights in the Meridian Creek watershed were accounted for in determining the inflow estimates for each site. Water rights in Meridian Creek are located in the upper headwaters of Meridian Creek and Spring Creek and are relatively insignificant (total less than 250 acre-feet per year).

Each of the reservoirs considered for Alternative 2 are on-channel reservoirs. These reservoirs capture runoff from the upstream watershed and also would capture sediment from the upstream watershed that would be trapped in the reservoir pool. Over a long period of time, sediment accumulation can significantly reduce the reservoir storage capacity and must be accounted for in sizing the structure. A review of long-term sediment accumulation in Lake Waco (TDWR, 1982) and the sedimentation rates estimated for the proposed Lake Bosque project (HDR, 1988) resulted in the adoption of an average annual sedimentation rate of 0.20 acre-feet per square mile per year for the Meridian Creek watershed. A sediment pool was incorporated into each of the reservoirs based on the estimated sediment volume for the 50-year period from year 2000 to 2050. This volume was essentially set aside in the reservoir for sediment accumulation and was not considered as part of the effective storage volume for water supply. Due to the relatively small reservoir size as compared to the watershed area, the 50-year sediment pool volume was a significant component of the total reservoir storage volume ranging from 12 percent to 34 percent of the total storage volume of the reservoir.

The evaluations of the five potential reservoir sites included consideration of instream flow needs for fish and wildlife. The on-channel reservoirs on Meridian Creek generally create a larger environmental impact than the off-channel reservoirs evaluated in Alternative 1 due to the larger area of land inundated by the reservoir pool and potential reductions in downstream flow for major streams. A reservoir operation policy that has been used in other areas of the state for evaluation of future reservoirs (HDR, 1994) was applied to Alternative 2. Monthly minimum flows were assumed to equal typical flows at each site measured in terms of the average flow or median flow depending on the month of the year. The reservoirs were assumed to pass inflow up to these minimum flow rates for periods when the reservoir is above 60 percent of its conservation storage capacity. When the reservoir level declines to below 60 percent of the

SECTION 4 - SURFACE WATER SUPPLY ALTERNATIVES

conservation storage capacity, minimum flow rates for each month were reduced to the median daily flow rate estimated for the drought of record during the 1980's

Reservoir operation analyses were simulated at each site on a monthly time step for the 1946-1987 period using an original computer model RESSIM (HDR, 1994). The RESSIM model simulates reservoir contents over a historical period accounting for the fluctuation in reservoir storage and surface area, net evaporation from the reservoir pool, diversions from the reservoir for water supply, releases for downstream water rights and instream flow needs, and spills during flood events. RESSIM was used to determine the total storage volume required for each of the five sites to produce a firm yield equal to the projected regional 2050 water demand of 1,297 acre-feet per year. An example of the results from the reservoir operation simulation is shown in Figure 4-13. Figure 4-13 shows the monthly reservoir level trace for the 1946-87 period for site MC-5 (Spring Creek Reservoir). Two significant drought periods were experienced during the historical record. These drought periods are highlighted in Figure 4-13 by the significant declines in reservoir storage in the 1950's and 1980's. The drought period of the 1980's ultimately determined the storage volume requirement for this site as well as the other four sites considered for Alternative 2.

The required storage volumes to produce a firm yield of 1,297 acre-feet per year for each of the sites considered ranged from 4,360 acre-feet to 5,300 acre-feet. Table 4-6 summarizes the required storage capacity, sediment pool capacity, and watershed size for each of the five sites

Table 4-6				
Alternative 2				
Meridian Creek Reservoirs				
Potential Site ¹	Watershed Area (square miles)	Total Storage Volume ² (acre-feet)	Total Surface Area ³ (acres)	Sediment Pool Volume ⁴ (acre-feet)
MC-1	178	5,300	327	1,780
MC-2	151	5,130	328	1,510
MC-3	85	4,360	257	850
MC-4	79	4,470	276	790
MC-5	57	4,750	264	570
Notes: 1) Sites located on Meridian Creek or major tributary to Meridian Creek. 2) Total storage volume includes conservation storage and sediment pool storage volume. 3) Total surface area is defined as the surface area at normal pool level. 4) Sediment pool volume based on 50-year sedimentation volume assuming 0.20 acre-feet per square mile per year.				

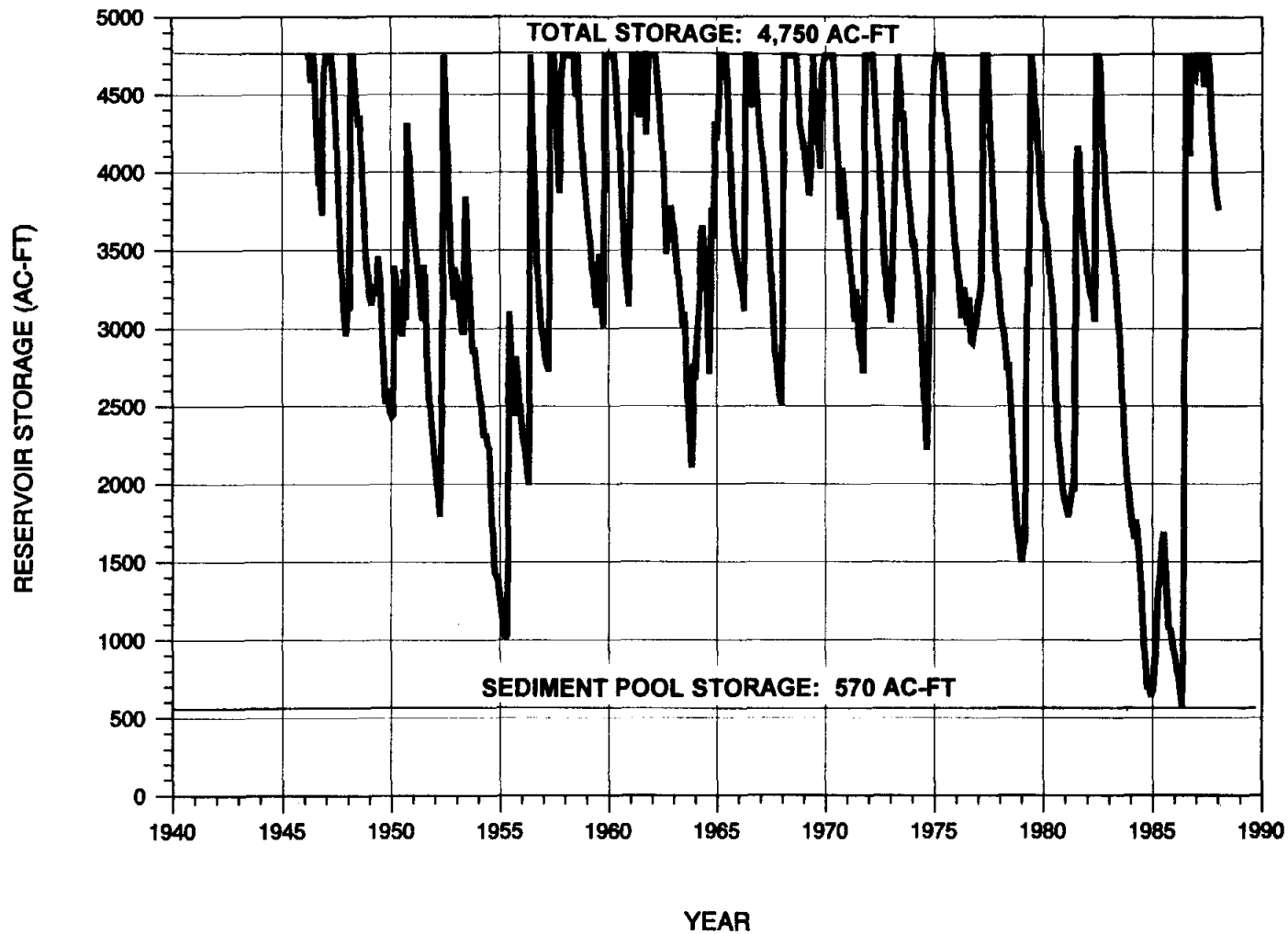

CITY OF CLIFTON AND CITY OF MERIDIAN
REGIONAL WATER SUPPLY STUDY

**SPRING CREEK RESERVOIR
OPERATION SIMULATION**



HDR Engineering, Inc.

FIGURE 4-13

SECTION 4 - SURFACE WATER SUPPLY ALTERNATIVES

considered in the Meridian Creek watershed.

4.4.2 Water Quality

Based on available data, the water quality of Meridian Creek appears to be of better quality than in the North Bosque River. As previously shown in Table 4-3, the suspended solids in Meridian Creek appear to be significantly less than in the North Bosque River, which will result in lower turbidities (cloudiness). However, pre-sedimentation is expected to occur in the reservoir resulting in low turbidity entering the water treatment plant. The suspended matter in the raw water delivered to the treatment plant for Alternative 2 should be similar to Alternative 1 due to the storage time in the reservoirs prior to delivery. The reservoirs proposed for Alternative 2 are located on major streams, rather than off-channel as proposed in Alternative 1. Sedimentation should occur in the reservoirs on Meridian Creek so that the lake yields low turbidity water as long as high flows are not entering the reservoir. Flood flows into the reservoir will bring large amounts of sediment and will result in a rise in turbidity entering the treatment plant. The result will be shorter filter run-times and a rise in the operating cost of the plant as more chemicals are required to treat the water. In contrast to the off-channel reservoirs, the Meridian Creek Reservoirs will not have the option of controlling diversions when water quality is poor.

Meridian Creek does contain a slightly lower amount of organics as indicated by the lower values of total organic carbon. The lower amount of organics will be an advantage in meeting the regulations now being developed for disinfection by-products

4.4.3 Water Treatment

The water treatment approach for Alternative 2 will be similar to the processes described for Alternative 1 (Section 4.3.3). The package-type treatment units can be used, with safeguards built in to handle the high turbidity raw water expected during flood periods.

SECTION 4 - SURFACE WATER SUPPLY ALTERNATIVES

4.4.4 Dams and Reservoirs

Five potential sites were evaluated in the Meridian Creek watershed for Alternative 2. Four of the sites were located on Meridian Creek and the fifth site was located on Spring Creek about one mile upstream of its confluence with Meridian Creek. The locations of these sites, designated MC-1 through MC-5, were shown in Figure 4-1. The selection of these sites was based on topographic suitability for construction, proximity to Clifton and Meridian, and potential relocations. USGS 7.5 minute series topographic maps were utilized for the selection of potential dam sites and to develop elevation-area-capacity relationships for the reservoirs. Suitable geologic conditions for dam and reservoir construction were assumed to occur at each site. A cursory site reconnaissance was performed at each of the potential reservoir sites and no “fatal” flaws that could prohibit construction were observed.

The topographic and geologic characteristics of the dam sites and surrounding area are conducive to earth fill, as opposed to concrete, dam construction. A typical earth dam cross section for the Meridian Creek dams would be the same as the off-channel dams and is shown in Figure 4-6. Suitable clay fill to construct the core and seepage cutoff for the dam is likely to be available within the immediate vicinity of the dam and reservoir. Random earth fill for the outer shells of the dam would be obtained from the required excavations, which would include the cutoff trench, principal spillway, and auxiliary spillway. It is anticipated that sand drain and rock riprap materials would need to be imported from a commercial quarry operation(s). However, extensive deposits of sand and gravel were observed in several locations along Meridian Creek and it may be possible to process sand from these alluvial deposits. The earth dam cross section presented is conceptual and would be refined during the design phase following thorough geologic and geotechnical investigations of the dam site and potential construction material borrow areas.

Given their relatively large drainage areas compared to the off-channel sites, the sites in the Meridian Creek watershed require significant spillway capacity to safely pass large floods without overtopping the earth dam. A typical profile for a dam on Meridian Creek is shown in Figure 4-14. As much as 27 feet of freeboard would be required above the normal pool elevation of the reservoir to the top of the dam for passing project design floods. The magnitude of the

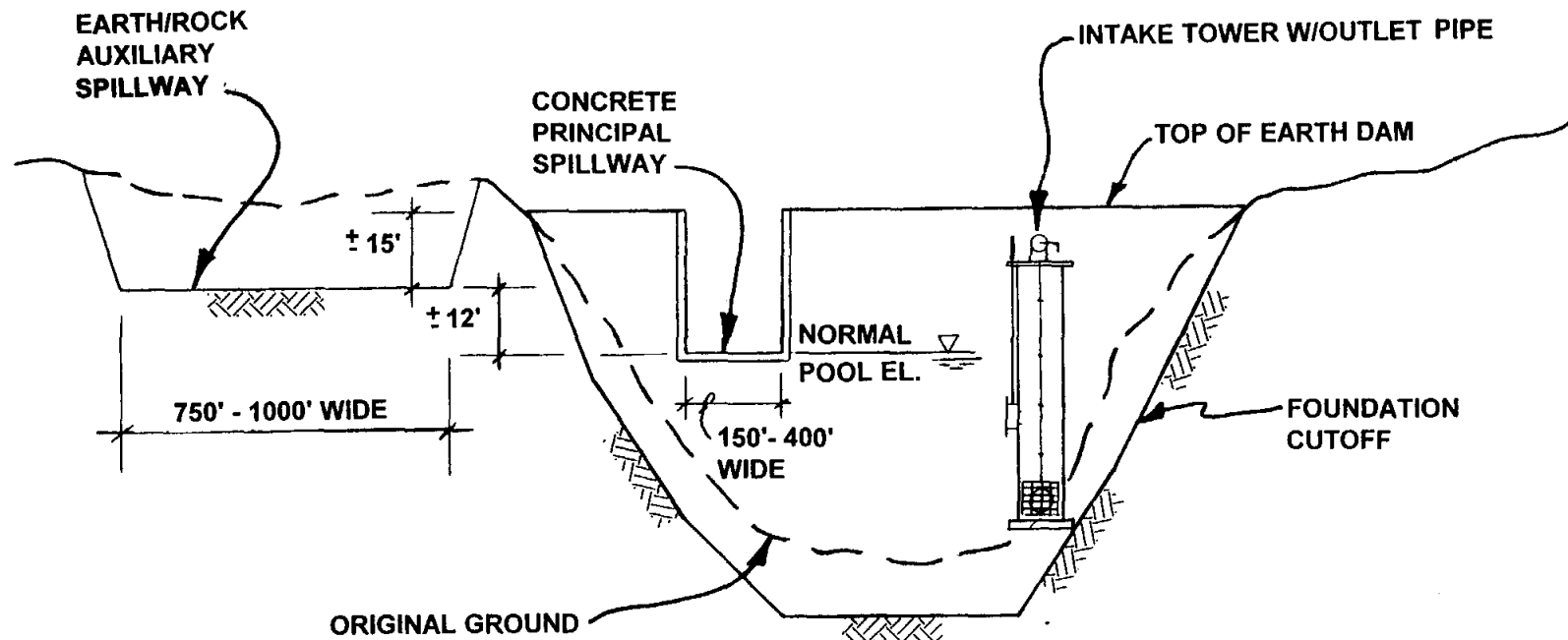

NOT TO SCALE



HDR Engineering, Inc.

CITY OF CLIFTON AND CITY OF MERIDIAN
REGIONAL WATER SUPPLY STUDY

**TYPICAL PROFILE
MERIDIAN CREEK DAM**

FIGURE 4-14

SECTION 4 - SURFACE WATER SUPPLY ALTERNATIVES

design flood is site specific and is determined based on the Texas Natural Resource Conservation Commission (TNRCC) Hydrologic Criteria for Dams and a detailed hydrologic analysis of the watershed above the dam. The principal spillway would consist of a concrete chute with an ogee overflow crest and would be sized to pass at least the 25-year flood event prior to engaging the auxiliary or emergency spillway. Because the auxiliary spillway is likely to be excavated in earth and/or rock, it is desirable to minimize its frequency of operation to prevent long-term erosion damage. The principal spillway crest widths required to pass the 25-year flood event ranged from 150 to 400 feet wide depending on the site. Sites MC-1 and MC-2, which have the largest drainage areas, required a 400-foot wide principal spillway to pass the 25-year flood event. Sites MC-3 and MC-4 required a 250-foot wide spillway, while site MC-5 on Spring Creek, which has the smallest drainage area, required a 150-foot wide principal spillway. Emergency spillway widths were selected by determining an approximate balance between spillway excavation and earth fill volumes for the dam, as well as maintaining reasonable maximum flow depths through the spillway.

Water would be delivered by gravity from the reservoir to a pump station downstream of the dam through the intake tower and an outlet pipe beneath the dam. A 36-inch outlet pipe was selected considering potential inspection and maintenance requirements. This pipe would also serve to drain the reservoir in the event of an emergency, as required by the TNRCC. The design of the intake tower would allow for withdrawal of water from selected depths in the reservoir to obtain the best quality water for treatment.

The estimated construction costs for the dams and reservoirs were found to be highly dependent on the drainage area and required spillway capacity. Site MC-5 on Spring Creek was determined to be the lowest cost dam, primarily because of the relatively small principal spillway. Site MC-4, just below the confluence with Mustang Creek, was only slightly more expensive than site MC-5, however, this site is the furthest from Clifton and Meridian. Site MC-3 was determined to be the most costly, primarily because of the need to relocate a gas pipeline which passes through the proposed reservoir. Sites MC-1 and MC-2 were significantly more expensive than MC-5, because of their large drainage areas and spillway requirements.

Site MC-5 was selected as the recommended site on the basis of cost and proximity to Clifton and Meridian. A site plan of the proposed dam and reservoir is presented in Figure 4-15.

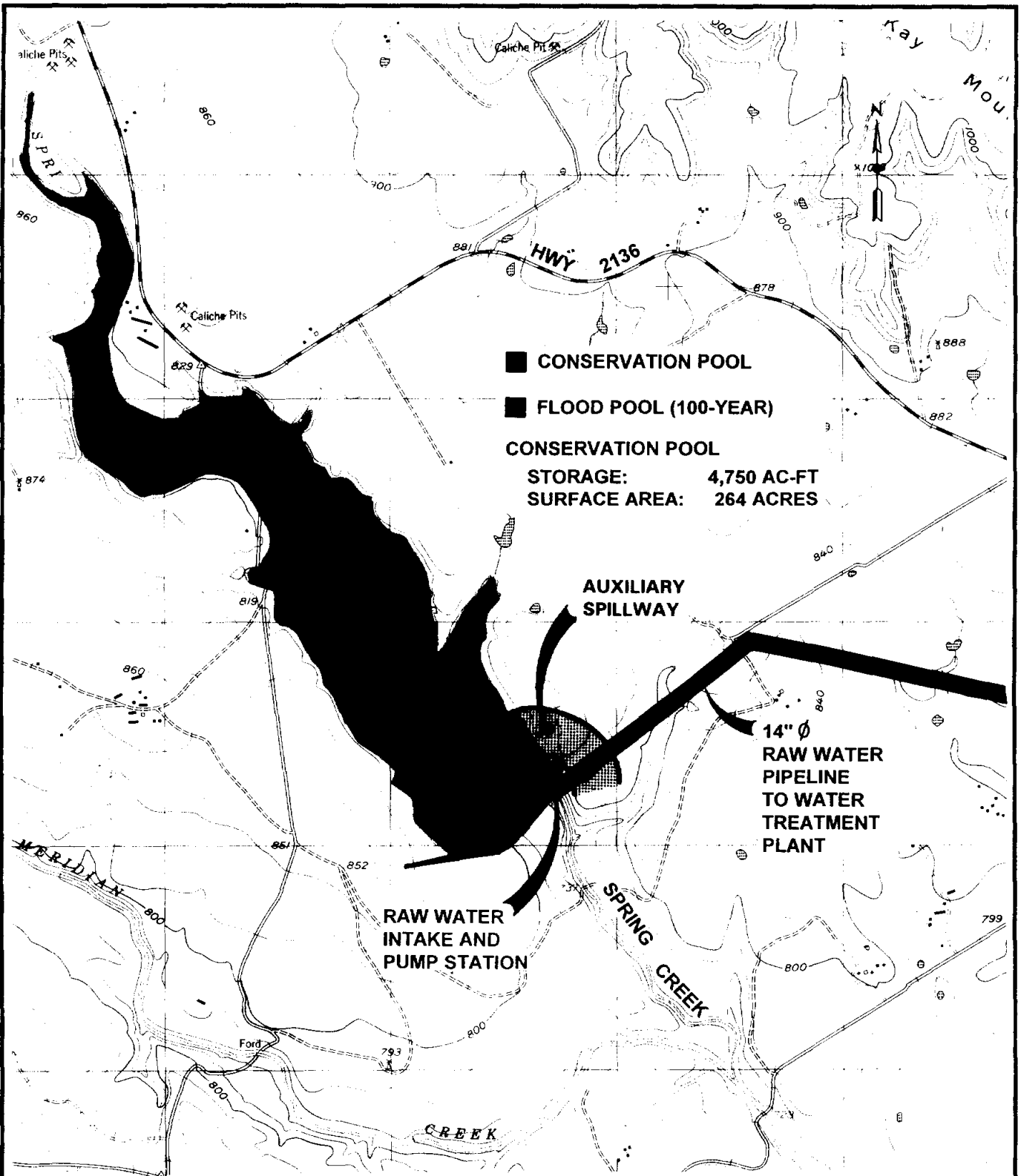

■ CONSERVATION POOL
 ■ FLOOD POOL (100-YEAR)
CONSERVATION POOL
 STORAGE: 4,750 AC-FT
 SURFACE AREA: 264 ACRES

SCALE 1" = 2000'

CITY OF CLIFTON AND CITY OF MERIDIAN
REGIONAL WATER SUPPLY STUDY



**ALTERNATIVE 2
SPRING CREEK RESERVOIR**

HDR Engineering, Inc.

FIGURE 4-15

SECTION 4 - SURFACE WATER SUPPLY ALTERNATIVES

The dam would be approximately 85 feet high and 2,700 feet long, and would impound a 4,750 ac-ft reservoir (264 surface acres). The auxiliary spillway would be excavated around the east end of the dam and discharge into an existing draw. The maximum water surface resulting from the 100-year flood event was computed to be approximately 812 ft-msl and would not effect Highway 22 or Highway 2136.

4.4.5 Regional Distribution System

The distribution system to deliver surface water to Clifton and Meridian for Alternative 2 is shown in Figure 4-16. The criteria used for sizing the pipelines and pump stations was the same as that used in Alternative 1. A raw water intake and pump station would deliver raw water to the regional surface water treatment plant, located near the intersection of Highway 6 and Highway 2136 between Clifton and Meridian, through a 6.3 mile, 14-inch diameter pipeline. After treatment, the water would be pumped from a high service pump station to each city. A 3.8 mile, 12-inch diameter pipeline would deliver water to ground storage tanks in Clifton and a 7.3 mile, 8-inch diameter pipeline would deliver water to a ground storage tank in Meridian. All pipelines and pump stations in the regional distribution system would be capable of supplying the peak day demands.

4.4.6 Project Cost Estimate

A cost estimate for Alternative 2 was computed in terms of capital cost, annual debt service, and operation and maintenance cost including power. The cost estimate shown in Table 4-7 is for facilities sized to meet the 2050 average and peak day demands. The total capital cost was estimated to be \$12,183,000, resulting in annual debt service of \$1,046,000 assuming an interest rate of 7.0 percent for 25 years. Annual O&M costs were estimated to be \$273,000 which is slightly less than the O&M costs estimated for Alternatives 1A and 1B.

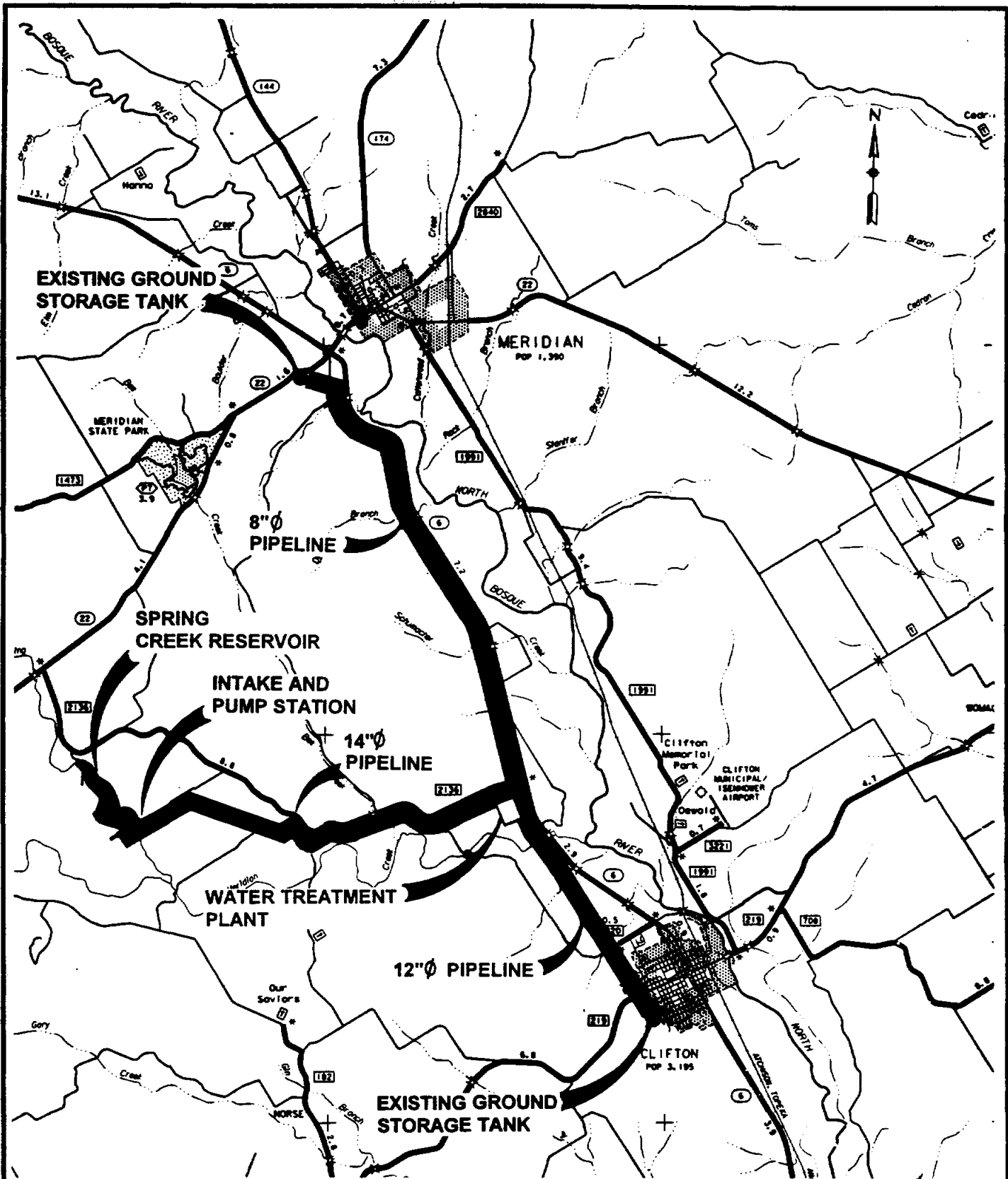

**CITY OF CLIFTON AND CITY OF MERIDIAN
REGIONAL WATER SUPPLY STUDY**

**ALTERNATIVE 2
REGIONAL SYSTEM**



HDR Engineering, Inc.

FIGURE 4-16

SECTION 4 - SURFACE WATER SUPPLY ALTERNATIVES

**Table 4-7
Alternative 2 - Project Cost Estimate
Spring Creek Reservoir**

Facility	Capital Cost ¹	Annual Debt Service ²	O&M Cost	Total Annual Cost
Spring Creek Dam & Reservoir	\$5,429,000	\$134,000	\$21,000	\$155,000
Raw Water Pumping Facilities ³	\$1,560,000	\$466,000	\$26,000	\$492,000
Water Treatment Plant ⁴	\$3,238,000	\$278,000	\$185,000	\$463,000
Regional Distribution System ⁵	\$1,956,000	\$168,000	\$41,000	\$209,000
Total	\$12,183,000	\$1,046,000	\$273,000	\$1,319,000
City of Clifton (70%) ⁷	\$8,528,000	\$732,000	\$191,000	\$923,000
City of Meridian (30%) ⁷	\$3,655,000	\$314,000	\$82,000	\$396,000

Notes:
 1) Includes 10% for construction contingencies and 15% for engineering, surveying, permitting, legal, and financial services.
 2) Annual debt service based on an interest rate of 7.0% over 25 years.
 3) Raw water pumping facilities include a raw water pump station and 6.3 mile raw water pipeline (14-inch diameter) to the water treatment plant.
 4) Water treatment plant consists of a 3 mgd package treatment plant, sitework, and access road.
 5) Regional distribution system includes a high service pump station and pipelines to deliver treated water for peak day demands to Clifton and Meridian.
 7) Proportion between Clifton and Meridian based on average annual water use.

SECTION 4 - SURFACE WATER SUPPLY ALTERNATIVES

4.5 Alternative 3 - Lake Whitney Demineralization

Alternative 3 is an evaluation of the potential for purchasing water from Lake Whitney, which is located approximately 13 miles east of Clifton and Meridian. Previous water supply studies (HDR, 1982; CDM, 1986) for entities in Bosque County have evaluated Lake Whitney as a potential source of water for Bosque County and have found it not to be as economical as other supply alternatives in the area. An updated cost estimate to provide treated water from Lake Whitney to Clifton and Meridian to meet the projected 2050 water supply demands was developed in this study. The facilities required to deliver treated water from Lake Whitney to Clifton and Meridian are:

- Lake Whitney raw water intake and pump station;
- raw water pipeline from intake to treatment plant;
- demineralization water treatment plant near Lake Whitney;
- high service pump station; and
- distribution pipelines to Clifton and Meridian.

4.5.1 Surface Water Availability from Lake Whitney

Lake Whitney was constructed on the Brazos River by the Corps of Engineers as a flood control and hydroelectric project in 1951. The reservoir has a total conservation storage of approximately 411,100 acre-feet and since its construction the minimum reservoir contents recorded was 250,200 in 1956. For purposes of this study, surface water was assumed to be available from Lake Whitney for purchase from the Brazos River Authority to meet the projected 2050 demands of Clifton and Meridian of 1,297 acre-feet per year.

4.5.2 Lake Whitney Water Quality

Lake Whitney water is very high in dissolved minerals as shown in Table 4-8. The maximum recorded level of 2,200 milligrams per liter of total dissolved solids indicates that the water can be classified as brackish. The drinking water standard of 500 milligrams per liter listed in the table is the federal recommended level; however, the state permits drinking water sources with levels up to 1,000 milligrams per liter. Lake Whitney also contains high levels of chlorides and sulfates. The chloride levels combine with other elements present and give the

SECTION 4 - SURFACE WATER SUPPLY ALTERNATIVES

water a salty taste. Sulfates combine to form hydrogen sulfide gas and can give the water a rotten egg smell.

Unlike particulate or microbiological matter found in the North Bosque River and Meridian Creek, dissolved minerals cannot be removed by conventional treatment. Instead, a separate demineralization step would be required in the treatment process.

Table 4-8 Alternative 3 Available Water Quality Data¹					
Constituent	Drinking Water Standards	Ground Water	North Bosque River	Meridian Creek	Lake Whitney
Total Dissolved Solids, mg/l ²	500	450-500	200-300	N/A	850-2200
Total Hardness, mg/l	---	10-70	N/A	N/A	350-400
Total Alkalinity, mg/l ³	120	300-350	175-250	150-160	150-250
pH	>7.0	7.0-8.5	7.8-8.3	8.0-8.1	7.5-8.5
Total Organic Carbon ³	4-8	N/A	4.0-5.0	2.0-3.0	N/A
Chlorides, mg/l	250	20-30	50-65	15-20	300-900
Sulfates, mg/l ⁴	300	50-55	50-60	30-35	200-500
Total Suspended Solids, mg/l	---	N/A	30-40	5-20	N/A

Note:

- 1) Data taken from USGS stream gage data, Intensive Survey of North Bosque River by Brazos River Authority, and Texas Natural Resource Conservation Commission Water Analysis.
- 2) EPA/World Health Organization recommended standard. TNRCC Drinking Water Secondary Standard is 1000 mg/l which is enforced as a primary standard for new water supplies.
- 3) Trigger levels for total organic carbon removal in currently proposed enhanced surface water treatment rule for total alkalinity > 120 mg/l and total organic carbon in the range of 4 to 8 would require 25% removal of total organic carbon.
- 4) EPA is currently developing a sulfate rule with a proposed primary standard of 500 mg/l.

4.5.3 Water Treatment

Demineralization is the removal of dissolved minerals such as calcium, chlorides, and sulfates from the water. As shown in Figure 4-17, demineralization is achieved as a separate step following a conventional treatment process. The typical processes used for municipal applications utilize semi-permeable membranes to remove the dissolved minerals. These processes are known as reverse osmosis and electrodialysis reversal.

Reverse osmosis utilizes high pressures to drive the dissolved minerals out of the water through a semi-permeable membrane in order to purify the water. Electrodialysis reversal uses an oscillating voltage potential to attract the charged mineral ions and pull them through semi-permeable membranes leaving purified water behind. Both processes concentrate the removed

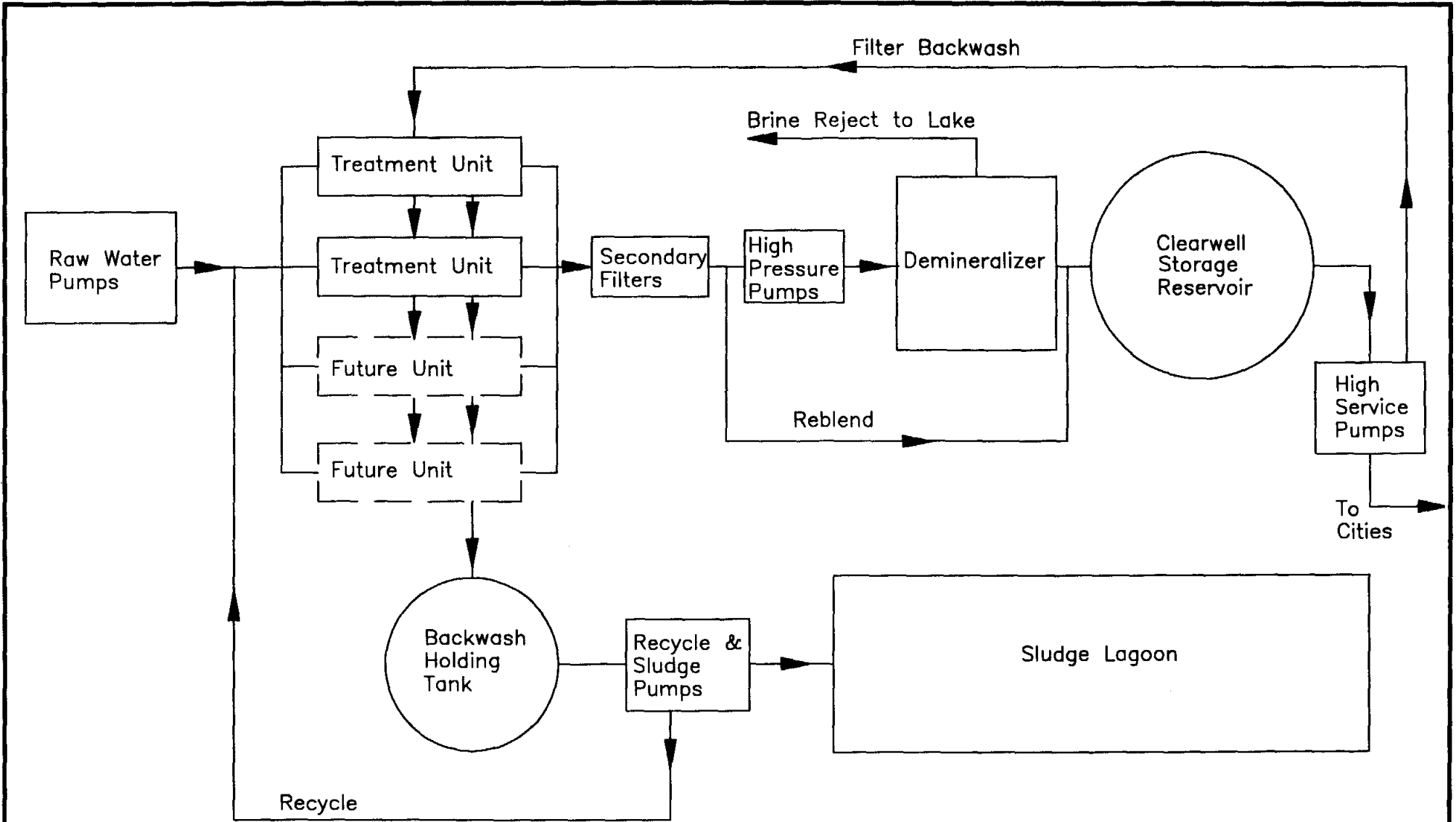

CITY OF CLIFTON AND CITY OF MERIDIAN
REGIONAL WATER SUPPLY STUDY

**LAKE WHITNEY
WATER TREATMENT PLANT
PROCESS SCHEMATIC**

FIGURE 4-17



HDR Engineering, Inc.

SECTION 4 - SURFACE WATER SUPPLY ALTERNATIVES

minerals into a separate sidestream, called brine, or concentrate. The brine usually resembles sea water and consists of very high concentrations of minerals. Typical installations reject about 30% of the water fed to the demineralizer process as brine.

Brine disposal can become a complicated issue in environmentally sensitive areas. In the case of Lake Whitney, it appears that the volume of water in the lake would be more than sufficient to dilute the concentrated brine and absorb it without impact to lake quality. Prior to construction, the brine disposal system will require several permits and be subject to environmental analysis. If these analyses determine that returning the brine to the lake is not feasible, other disposal methods will be required. Brine can also be evaporated in shallow ponds, but this approach is extremely expensive and requires a large amount of land. Deep well injection has also been used for disposal. Brine is injected into a well terminating in a naturally occurring brackish aquifer. However, severe environmental concerns have been raised in the past which cast doubt on the feasibility of using this disposal method.

The semi-permeable membranes used in the demineralization processes are very susceptible to clogging, or fouling, due to particulate or microbiological matter in the water. As a result, as shown in Figure 4-17, a conventional treatment system is required before the flow enters the demineralizer. The end result is basically two plants: one conventional treatment plant followed by a demineralizer. The reverse osmosis and electro dialysis reversal processes are expensive to construct and require a large amount of power to drive the process. The resulting costs for treatment plant construction, operation, and maintenance are much higher than for conventional treatment.

The ultimate capacity of the treatment plant for this option will be 3.0 million gallons per day. Figure 4-18 shows a conceptual site plan of the proposed treatment plant. Note that an initial plant can be constructed with a smaller capacity and the ultimate capacity reached through a series of plant expansions which occur as demand warrants.

4.5.4 Regional Distribution System

The distribution system to deliver treated water from Lake Whitney to Clifton and Meridian is shown in Figure 4-19. The water treatment plant for Alternative 3 is proposed to be located in the immediate vicinity of Lake Whitney for convenient disposal of brine from the

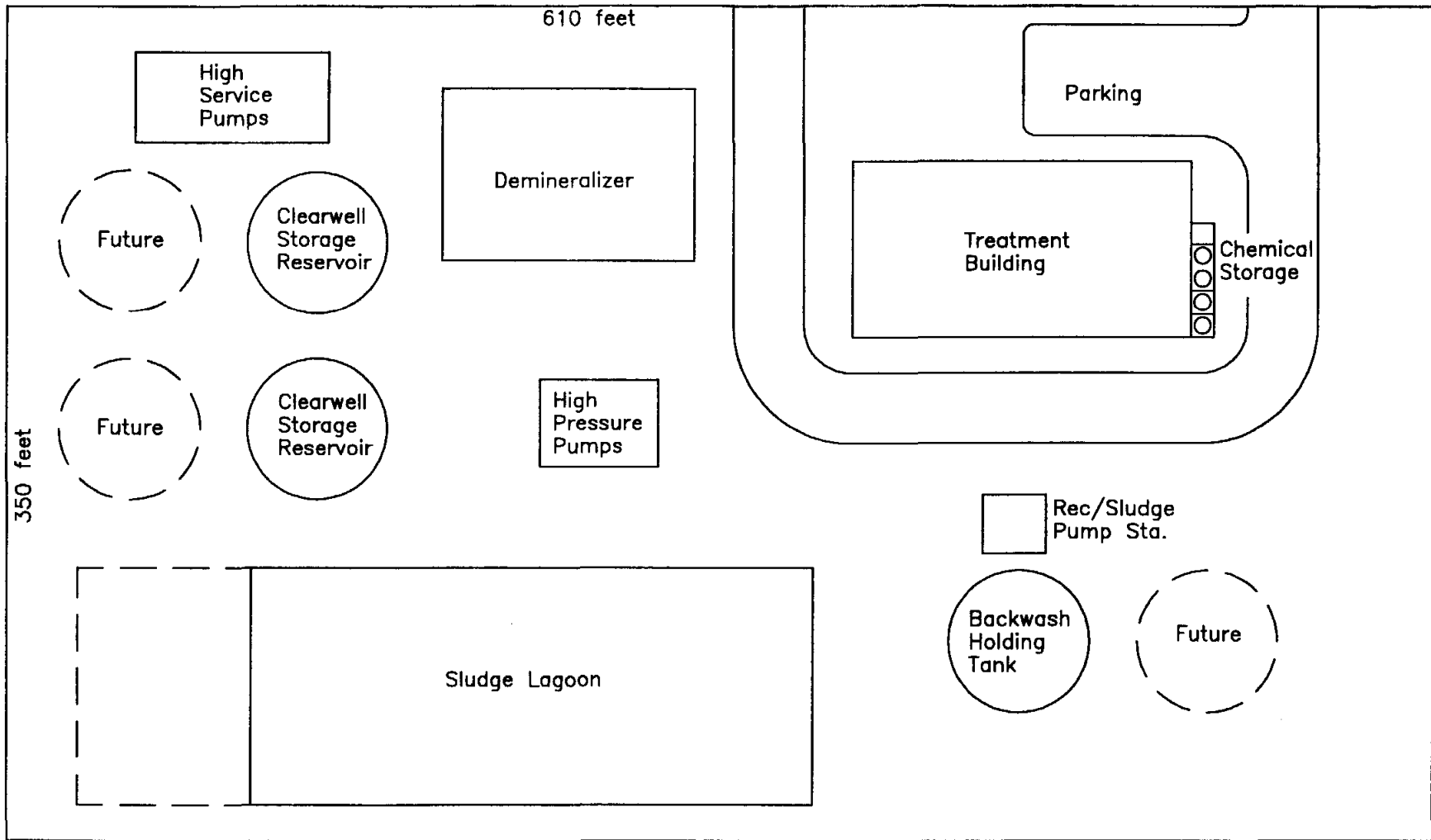

NOT TO SCALE



HDR Engineering, Inc.

CITY OF CLIFTON AND CITY OF MERIDIAN
REGIONAL WATER SUPPLY STUDY

**LAKE WHITNEY
WATER TREATMENT PLANT
CONCEPTUAL SITE LAYOUT**

FIGURE 4-18

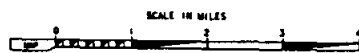
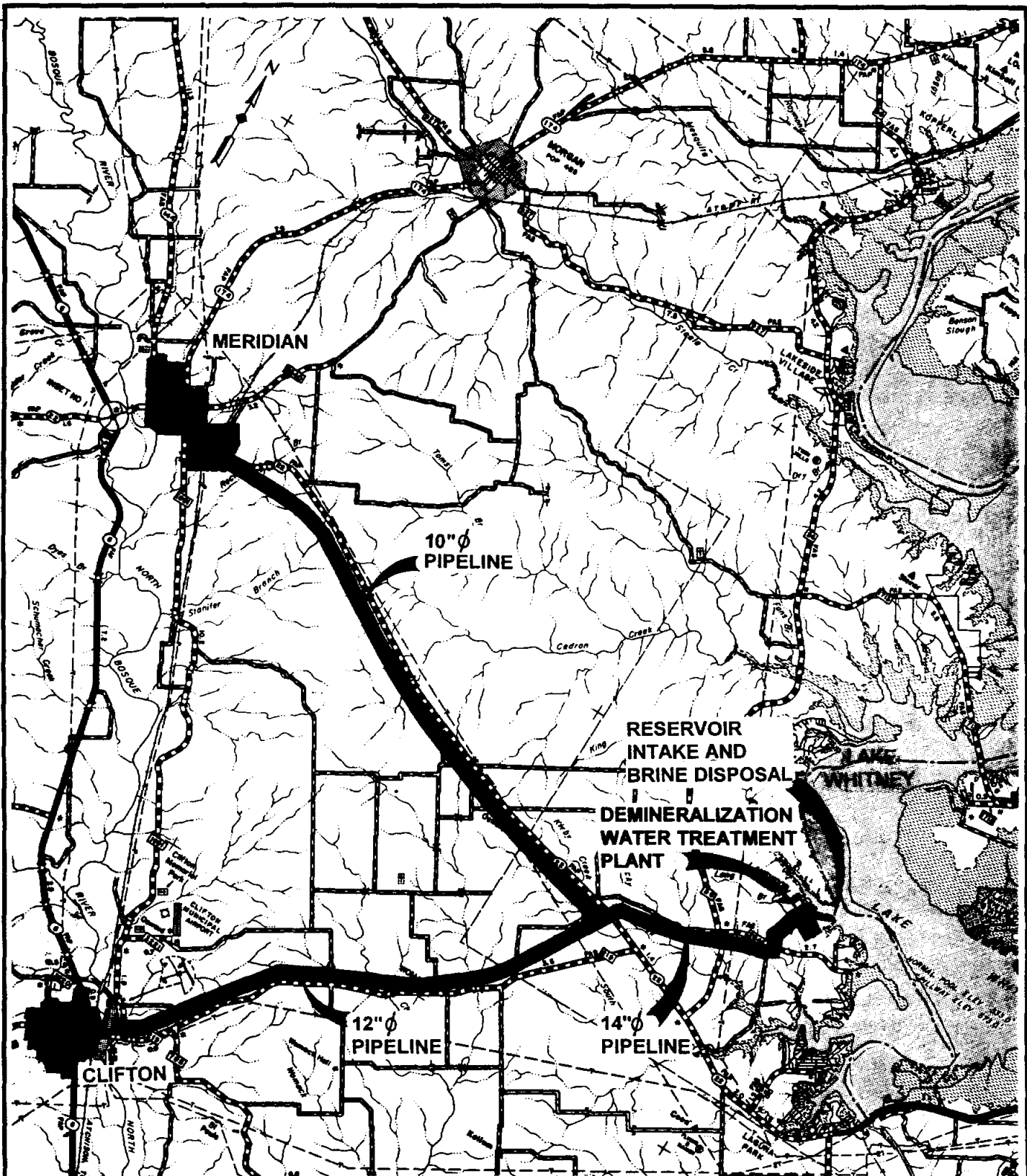

CITY OF CLIFTON AND CITY OF MERIDIAN
REGIONAL WATER SUPPLY STUDY

ALTERNATIVE 3
LAKE WHITNEY REGIONAL SYSTEM



HDR Engineering, Inc.

FIGURE 4-19

SECTION 4 - SURFACE WATER SUPPLY ALTERNATIVES

plant back into the lake. Treated water would be pumped by a high service pump station from the treatment plant to ground storage tanks in Clifton and Meridian. The system was sized to meet the year 2050 peak day demands. As a result of the long distance from Lake Whitney to Meridian, a 10-inch diameter pipeline was sized in order to avoid excessive line pressures near the pump station. Pumping costs from Lake Whitney are expensive because of having to pump water over the watershed divide between Lake Whitney and the two cities. The regional distribution system for this alternative is much more extensive than Alternative 1 and Alternative 2 with a total of 25 miles of pipelines as compared to about 11.5 miles for Alternative 1 and 17 miles for Alternative 2.

4.5.5 Project Cost Estimate

A cost estimate was prepared for Alternative 3 in terms of capital cost, annual debt service, and operation and maintenance cost including power. The cost estimates were made assuming facilities would be sized to meet ultimate 2050 peak day demands. Table 4-9 summarizes the estimated cost for each of the major project components. The total capital cost for Alternative 3 was estimated to be \$16,957,000. The annual debt service would be \$1,456,000 based on an interest rate of 7.0 percent and a financing period of 25 years. The annual O&M costs were estimated to be approximately \$681,000 which are significantly greater than the O&M costs for Alternative 1 and Alternative 2 due to the operation of the demineralization water treatment plant and pumping costs from Lake Whitney to Clifton and Meridian. The total annual cost for Alternative 3 was estimated to be \$2,137,000 which is also much larger than total annual cost estimated for Alternative 1 and Alternative 2.

SECTION 4 - SURFACE WATER SUPPLY ALTERNATIVES

Table 4-9				
Alternative 3 - Project Cost Estimate				
Lake Whitney Demineralization				
Facility	Capital Cost ¹	Annual Debt Service ²	O&M Cost	Total Annual Cost
Raw Water Intake/Pumping Facilities ³	\$1,188,000	\$102,000	\$72,000 ⁴	\$174,000
Demineralization Water Treatment Plant ⁵	\$10,879,000	\$934,000	\$503,000	\$1,437,000
Regional Distribution System ⁶	\$4,890,000	\$420,000	\$106,000	\$526,000
Total	\$16,957,000	\$1,456,000	\$681,000	\$2,137,000
City of Clifton (70%) ⁷	\$11,870,000	\$1,019,000	\$477,000	\$1,496,000
City of Meridian (30%) ⁷	\$5,087,000	\$437,000	\$204,000	\$641,000

Notes:

- 1) Includes 10% for construction contingencies and 15% for engineering, surveying, permitting, legal, and financial services.
- 2) Annual debt service based on an interest rate of 7.0% over 25 years.
- 3) Raw water pumping facilities include an intake in Lake Whitney, 1,000 ft. of raw water pipeline (18" diameter) to the water treatment plant, and brine disposal.
- 4) O&M costs include the annual cost of raw water from Lake Whitney assumed to be approximately \$19 per acre-foot per year.
- 5) Water treatment plant consists of a 3 mgd package treatment plant, sitework, and access road.
- 6) Regional distribution system includes a high service pump station and pipelines to deliver treated water for peak day demands to Clifton and Meridian.
- 7) Proportion between Clifton and Meridian based on average annual water use.

**SECTION 5 - RECOMMENDED ALTERNATIVE AND
IMPLEMENTATION PLAN**

5.0 RECOMMENDED ALTERNATIVE AND IMPLEMENTATION PLAN

5.1 Recommended Alternative

The recommended alternative to meet the future water supply needs of Clifton and Meridian is Alternative 1A - Diversion from the North Bosque River with Off-Channel Reservoir Storage near Clifton. This is the most economical alternative for meeting the long-term water supply needs of Clifton and Meridian and would be the least expensive to the current customers to implement initially. As shown in Table 5-1, Alternative 1A is about 16 percent less costly than Alternative 1B, about 18 percent less costly than Alternative 2, and is about 50 percent less costly than Alternative 3.

Table 5-1 Summary of Costs for Alternatives Year 2050¹				
Alternative	Total Capital Cost ²	Annual Debt Service ³	Annual O&M Cost	Total Annual Cost ⁴
Alternative 1A Off-Channel Reservoir near Clifton	\$9,047,000	\$776,000	\$300,000	\$1,076,000
Alternative 1B Off-Channel Reservoir near Meridian	\$11,346,000	\$974,000	\$300,000	\$1,274,000
Alternative 2 Spring Creek Reservoir	\$12,183,000	\$1,045,000	\$273,000	\$1,318,000
Alternative 3 Lake Whitney	\$16,957,000	\$1,455,000	\$681,000	\$2,136,000
Lake Bosque Project Comparison⁵		\$1,182,000	\$272,000	\$1,454,000
Notes: 1) Regional water supply alternatives were sized to meet the ultimate 2050 water supply needs of Clifton and Meridian in order to evaluate the long-term cost of each alternative. 2) Total capital cost includes 10% for construction contingencies and 15% for engineering, surveying, permitting, environmental, legal, and financial services. 3) Annual debt service based on an interest rate of 7.0% over 25 years. 4) Total annual cost is the sum of annual debt service and annual O&M cost. 5) Includes the annual cost of the Lake Bosque commitment (assuming Meridian's share would be reduced by Iredell and Walnut Springs share) and annual cost of capital improvements and O&M required to deliver treated water from Lake Bosque to Clifton and Meridian.				

SECTION 5 - RECOMMENDED ALTERNATIVE AND IMPLEMENTATION PLAN

Alternative 1A is the most economical alternative primarily due to the utilization of Clifton's existing water right. Utilization of the existing water right in combination with the subordination of the Lake Waco water rights in the "Windup Agreement" results in reduced sizes for some of the required facilities, particularly the off-channel reservoir, as compared to the other alternatives considered. The large capital cost of the dam and reservoir for Alternative 2 is the primary reason this alternative is not as economical as Alternative 1A or 1B. Feasibility of this alternative would improve if a larger customer base could be established. Alternatives 1A, 1B, and 2 are all more economical than water from the proposed Lake Bosque because of the subordination of Lake Waco water rights. Without the subordination of Lake Waco water rights, Lake Bosque would still likely be identified as the overall least cost alternative for Clifton and Meridian if other entities were available to purchase the remaining yield of the project.

Alternative 1A is the most economical alternative over the long-term and, because most of the facilities can be staged, it is also the most economical alternative to implement initially for the existing customers. The off-channel reservoir concept offers a great degree of flexibility. Diversion from the North Bosque River to an off-channel reservoir can be selective so that diversions are temporarily suspended when the water quality is poor. The off-channel reservoir can be constructed in phases to match growth allowing Clifton and Meridian the opportunity to enlarge the system, if needed, and provide water to other surrounding entities in Bosque County when the need arises.

5.2 Implementation of the Recommended Alternative

The initial costs to existing customers to implement the recommended alternative to meet the ultimate 2050 water demands are considerable, as shown in Table 5-1. The ultimate project consists of raw water pumping facilities, an off-channel reservoir, a surface water treatment plant, and a regional distribution system. Raw water would be pumped from the North Bosque River to an off-channel reservoir which would impound an ultimate capacity of approximately 1,150 acre-feet. A channel dam would be constructed on the North Bosque River near the "Old Mill Dam" site to maintain a constant level for pumping from the North Bosque River, especially during times of low flow. A pump station would be constructed on the west side of the river to

SECTION 5 - RECOMMENDED ALTERNATIVE AND IMPLEMENTATION PLAN

divert water at a maximum rate of 9 cfs through an 18-inch diameter pipeline to the off-channel reservoir, located northwest of Clifton approximately 1.8 miles from the pump station. The off-channel reservoir would provide storage during drought periods to meet water demands and pre-sedimentation of the raw water prior to delivery to the water treatment plant, located just downstream of the off-channel reservoir. Water from the off-channel reservoir would be delivered by gravity to the water treatment plant through a 14-inch diameter pipeline. Treated water would be pumped approximately 1.1 miles from the water treatment plant to ground storage tanks in Clifton and approximately 10.0 miles to a ground storage tank in Meridian.

It is recommended that Alternative 1A be implemented in phases to lower the initial cost of the project. This could be accomplished by initially constructing only the facilities required to produce treated water to supply projected average day demands of 0.85 mgd for Clifton and Meridian in the year 2015 (Phase I). Demands in excess of 0.85 mgd could be met from the present groundwater supply. Typical monthly water use patterns for Clifton and Meridian projected for the years 2000 and 2015 are presented in Figure 5-1. These typical monthly patterns were developed based on analyses of water use by the two cities over the last 5 years. In the year 2015, average day demands in excess of 0.85 mgd are expected to occur primarily during the summer months of June, July, and August of a typical year. Peak day demands, however, may exceed 0.85 mgd in other months which would require some water from wells to meet these temporary demands. During periods of extreme drought in the North Bosque River watershed, there may be interruptions of the surface water supply (about five percent of the time) which will necessitate temporary reliance on existing wells. Through conjunctive management of surface and groundwater resources, customers in Clifton and Meridian may be assured of a firm, dependable and economical supply of water.

The new Phase I facilities required to produce a base surface water supply of 0.85 mgd to meet the needs of Clifton and Meridian until the year 2015 include:

Raw Water Pumping Facilities:

- New channel dam across the North Bosque River at the site of the "Old Mill Dam"
- Raw water intake and pump station to divert at a maximum diversion rate of 5 cfs

YEAR 2000

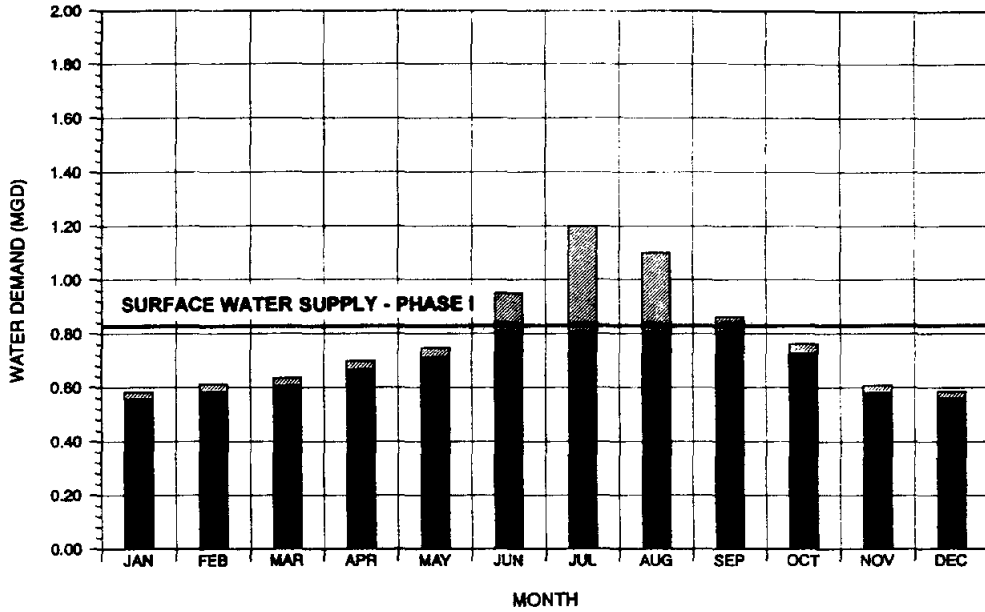

YEAR 2015

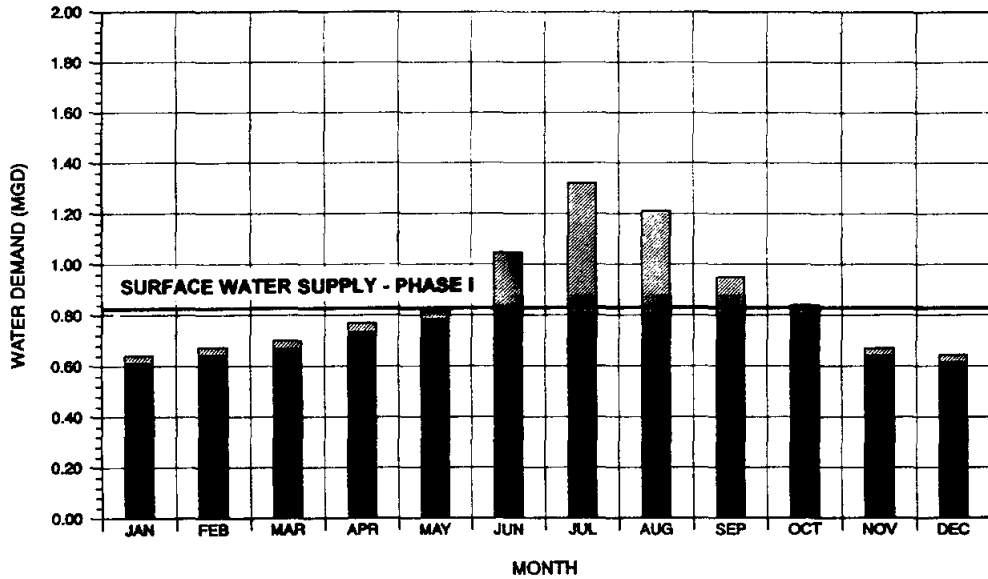

- SUPPLY FROM SURFACE WATER
- ▨ SUPPLY FROM GROUNDWATER

CITY OF CLIFTON AND CITY OF MERIDIAN
REGIONAL WATER SUPPLY STUDY



HDR Engineering, Inc.

PHASE I
MONTHLY SUPPLY PATTERN

FIGURE 5-1

SECTION 5 - RECOMMENDED ALTERNATIVE AND IMPLEMENTATION PLAN

- Raw water pipeline (18-inch diameter) to deliver raw water to the off-channel reservoir approximately 1.8 miles from the North Bosque River.

Off-Channel Reservoir:

- Off-channel dam and reservoir capable of storing approximately 250 acre-feet of raw water to meet average day demands for a 90 day consecutive period. The dam would be designed to facilitate enlargement to the ultimate 2050 storage capacity of 1,150 acre-feet.
- Intake tower to supply raw water to the water treatment plant.
- Approximately 52 acres of land required for ultimate 2050 project size.

Water Treatment Plant

- Package water treatment plant (1 mgd capacity) to supply the projected year 2015 average day demands of Clifton and Meridian.

Regional Distribution System

- 14-inch diameter pipeline to deliver raw water approximately 1,200 feet from the off-channel reservoir to the water treatment plant.
- High service pump station to deliver treated water to Clifton and Meridian to meet the average day demands.
- 12-inch diameter pipeline to deliver treated water approximately 1.1 miles to existing ground storage tanks in the Clifton water system.
- 8-inch diameter pipeline to deliver treated water approximately 10.0 miles to an existing ground storage tank in Meridian.

In addition to the above facilities, minor modifications to the existing water systems will be required to allow blending of groundwater and surface water in existing ground storage tanks.

A cost estimate for the Phase I system is presented in Table 5-2. The total capital cost is estimated to be \$6,647,000 and the resulting annual debt service would be \$570,000 per year based on financing terms of 7.0 percent interest for 25 years. Annual operating and maintenance costs are estimated to be approximately \$269,000, resulting in a total annual cost of \$839,000 including debt service. Actual increases in rates required to pay for the new surface water system will be dependent on the availability of any grants for the project and/or actual terms of financing the project. In order to properly assess the potential increases in water rates, a rate study should be performed after the project cost estimates are further refined.

**SECTION 5 - RECOMMENDED ALTERNATIVE AND
IMPLEMENTATION PLAN**

Table 5-2 Project Cost Estimate - Phase I Recommended Project - Alternative 1A				
Project Component	Capital Cost ¹	Annual Debt Service ²	Annual O&M Cost	Total Annual Cost
Raw Water Pumping Facilities	\$1,793,000	\$154,000	\$46,000	\$200,000
Off-Channel Dam & Reservoir	\$984,000	\$84,500	\$10,000	\$94,500
Off-Channel Reservoir Land (52 acres)	\$42,000	\$3,500	\$0	\$3,500
Water Treatment Plant (1 mgd)	\$2,287,000	\$196,000	\$183,000	\$379,000
Regional Distribution System	\$1,541,000	\$132,000	\$30,000	\$162,000
Total	\$6,647,000	\$570,000	\$269,000	\$839,000
City of Clifton (70%) ³	\$4,653,000	\$399,000	\$188,000	\$587,000
City of Meridian (30%) ³	\$1,994,000	\$171,000	\$81,000	\$252,000

Note:
 1) Includes 10% for construction contingencies and 15% for engineering, surveying, permitting, legal, and financial services.
 2) Annual debt service calculated assuming 7% interest over 25 years.
 3) Proportion between Clifton and Meridian based on average annual water use.

Well level declines in the Clifton and Meridian area show water levels may reach the top of the aquifer by the year 2005. However, with implementation of a surface water supply to satisfy the base water demands, the rate of decline of local well levels will likely decrease. Groundwater, if properly managed, is expected to provide a significant part of the total supply until at least the year 2015. An expansion of the surface water supply system could be necessary in 2015 based on projected groundwater declines and growth of the two cities. The Phase II system expansion will likely include:

- Modification of the raw water pump station to increase the pumping capacity from the North Bosque River from 5 cfs to 9 cfs.
- Enlargement of the off-channel reservoir to its ultimate capacity of 1,150 acre-feet.
- Expansion of the water treatment plant with additional package treatment units to increase the treatment capacity to 2 mgd to meet a greater portion of the average and peak day demands.
- Modification of the high service pump station from a pumping capacity of 1 mgd to 2 mgd.

A third expansion of the surface water supply system is projected to be necessary in 2030 to meet the water supply needs for the full planning period ending in 2050. Due to projected

SECTION 5 - RECOMMENDED ALTERNATIVE AND IMPLEMENTATION PLAN

growth in the rural areas of Bosque and surrounding counties, groundwater is not expected to be a dependable supply source beyond about 2030 for the two cities unless aquifer withdrawals are significantly reduced. The Phase III expansion will likely include the facilities necessary to deliver 3 mgd of treated surface water supply, thereby ensuring that projected water supply needs of Clifton and Meridian will be provided through at least 2050. The Phase III expansion will likely include:

- Expansion of the water treatment plant to a capacity of 3 mgd to meet average and peak day demands of Clifton and Meridian.
- Modification of the high service pump station to increase the pumping capacity from 2 to 3 mgd to deliver treated water to Clifton and Meridian.

The timing for implementation of Phase II and Phase III facilities presented herein are estimates. The proper points in time for implementation of the Phase II and III expansions should be based on the actual growth of Clifton and Meridian and the actual long-term rate of decline in well levels.

5.3 Schedule for Implementation of Phase I

Phase I of the recommended Alternative 1A can be implemented and operable within a period of about three years from initiation of data collection and permitting. A schedule for implementation of Phase I of the recommended project is presented in Figure 5-2. This schedule assumes permitting and detailed site investigations are initiated by September of 1995. Permits required to implement the project will likely include:

- Water rights permit for the 50-year planning needs (year 2050 demands) and authorization of storage of surface water in the off-channel reservoir;
- Section 404 permit from the U.S. Army Corps of Engineers for construction of the channel dam on the North Bosque River;
- Sand, gravel, and marl permit from Texas Parks and Wildlife Department for construction of the channel dam;
- General Land Office permit for use of state owned streambed; and
- Section 401 certification from the Texas Natural Resource Conservation Commission related to the Clean Water Act.

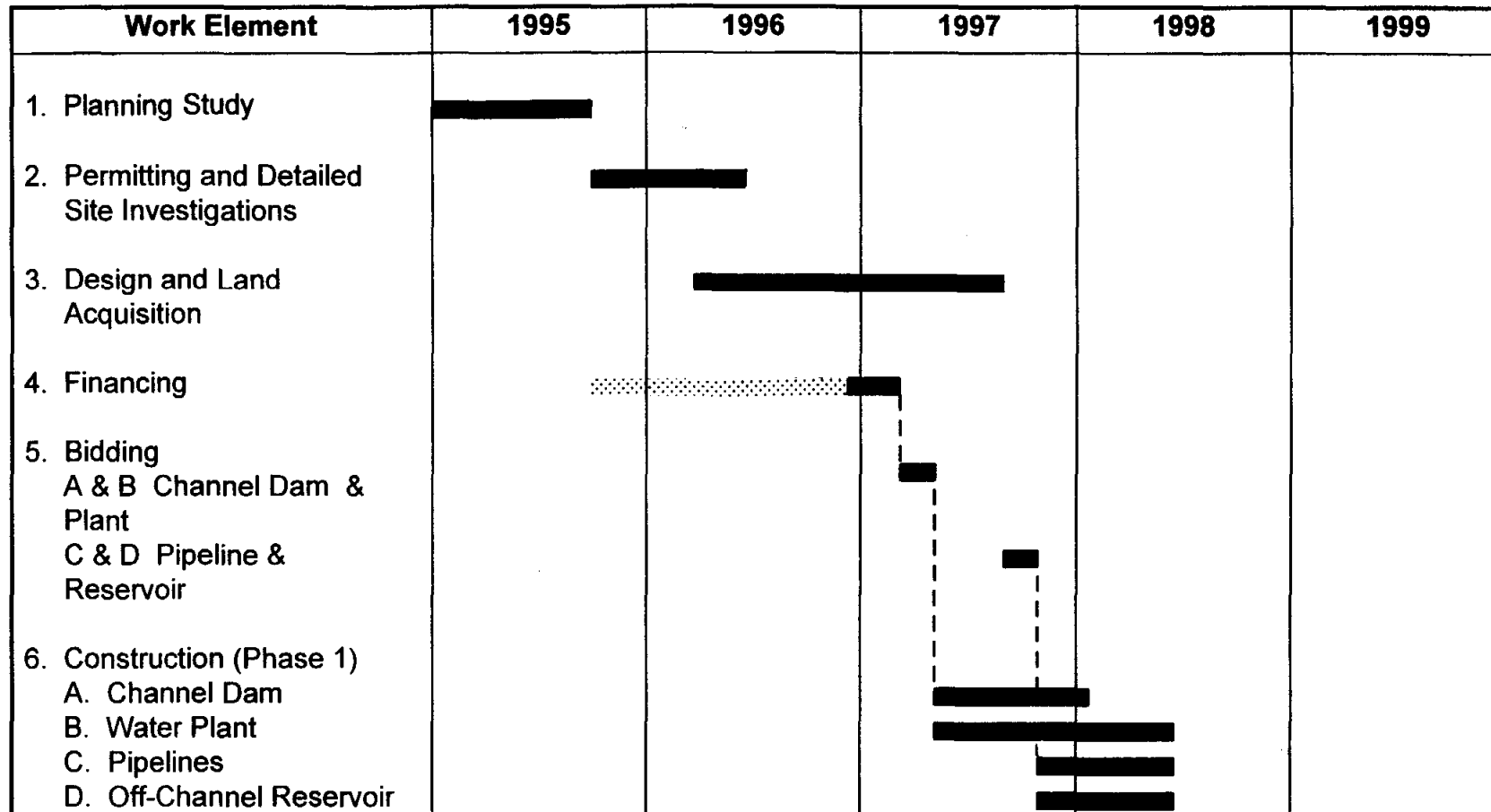

CITY OF CLIFTON AND CITY OF MERIDIAN
 REGIONAL WATER SUPPLY STUDY
PHASE 1 IMPLEMENTATION SCHEDULE



HDR Engineering, Inc.

FIGURE 5-2

SECTION 5 - RECOMMENDED ALTERNATIVE AND IMPLEMENTATION PLAN

Detailed geologic site investigations will need to be conducted for the off-channel reservoir site to verify water retention capability. Survey and geotechnical data will need to be collected for the off-channel dam site to gather sufficient data for design of the structure and to locate earth materials that may be utilized for construction of the dam. Detailed site and geotechnical investigations, including surveying, will also be required at the proposed channel dam and raw water intake and pump station locations to collect sufficient data for design of these structures. Water quality sampling and testing to provide detailed data on pathogen and organic concentrations, as well as other identified constituents in the North Bosque River, will need to be conducted in order to establish design criteria for the water treatment plant. An environmental study would also be required to identify site specific instream flow needs and any environmental mitigation requirements. It is possible that these work elements can be completed within eight months from initiation. Facility design would begin as soon as detailed data required for each component is obtained. Land acquisition could begin once the facility sites have been investigated and verified as suitable.

Financing and bidding of the project could begin as early as 1997. The channel dam, raw water intake and pump station, and water treatment plant would likely be bid first and followed by the pipelines and off-channel reservoir. The water treatment plant will likely take the longest to complete, therefore, it may need to be one of the first facilities bid in order to have the total Phase I system in operation by mid-1998.

5.4 Water Supply Financing Options

There are five major sources of financing for public water supply projects, including: (1) Bond Market; (2) Texas Water Development Fund; (3) State Participation Fund; (4) Community Development Block Grants; and (5) Rural Economic and Community Development Grants and Loans. Each source is discussed below.

5.4.1 Bond Market

Public agencies borrow funds in the financial markets through the issuance of bonds, then use the proceeds to construct public works projects such as water supply reservoirs, water wells,

SECTION 5 - RECOMMENDED ALTERNATIVE AND IMPLEMENTATION PLAN

pipelines, treatment plants, pump stations, storage tanks, and associated capital equipment. The bond holders are repaid with interest, using revenues and/or fees collected from those who receive water, from taxes levied on property in the water service area, or from a combination of revenues, fees, and taxes. In cases where public entities issue bonds to supply water to the public, the bonds are classified under federal laws as “tax-exempt.” On tax exempt bonds, the interest paid to bond holders is not classified as ordinary income; therefore, the bond holder does not have to pay income tax on the earnings from these investments. As a result, individuals and other investors are willing to lend their capital to governmental entities at lower interest rates than would be the case if the interest on those loans (bonds) were taxed by the federal government.

5.4.2 Texas Water Development Fund

The Texas Water Development Board (TWDB) has authority granted by Texas Constitutional Amendments and State Statutes to issue State of Texas General Obligation Bonds for providing loans to political subdivisions and special purpose districts for the construction of water supply, sewer, and flood control projects. The TWDB uses the proceeds of its bond sales to purchase the bonds (either general obligation or revenue) of cities and local water districts and authorities, which in turn use the borrowed funds to pay for construction of local projects. The local district or city repays the TWDB, with interest equal to the rate that the TWDB must pay on its bonds plus 0.5 percent, which the TWDB uses to retire the bonds it issued. The 0.5 percent assists the state in paying the cost of administering the loan program. This State of Texas water resources loan program enables some cities and local districts, especially smaller entities that do not have a credit rating, to utilize the credit of the state in financing projects and thereby obtain financing at lower interest rates than if they sold their bonds on the open bond market. The current interest rate on TWDB bonds is 6.6 percent.

To be eligible to borrow from the Texas Water Development Fund, the applicants must have: (1) authority to supply water; (2) a source of water; and (3) a water conservation plan, unless the applicant is exempted from this requirement. The conditions for exemption from a conservation plan are: 1) in cases of emergency; 2) for applications of \$500,000 or less; or 3) if the applicant demonstrates, and the TWDB finds, that a conservation plan is not necessary to

SECTION 5 - RECOMMENDED ALTERNATIVE AND IMPLEMENTATION PLAN

facilitate conservation. However, if the application is filed as an emergency case and is for a loan in excess of \$500,000, a conservation plan must be developed and implemented within six months of the date of the TWDB's approval of the loan.

In the case of individual cities and individual special purpose districts and authorities, the applicants must be classified as "hardship cases." In order to be classified as a "hardship case," the TWDB must determine that the applicant cannot secure financing in the open market or elsewhere at a reasonable rate of interest. Smaller districts or smaller cities that do not have a credit history and a credit rating usually meet the "hardship" criteria. However, the applicant must present evidence that it can repay the loan for which it is applying.

If the project for which the loan is needed is regional (i.e. serves more than one entity or serves an area involving more than one county, city, special district, or other political subdivision), then the hardship requirement does not apply. In other words, water supply loans can be obtained for regional water supply projects even though the members are not classified as hardship cases. Likewise, a surface water supply system which is developed to replace groundwater in critical groundwater areas can be financed with a loan from the TWDB even though the members are not classified as hardship cases. Thus, it appears that surface water projects in Bosque County would be eligible for loans from the TWDB for financing up to 100 percent of the costs of such projects.

5.4.3 State Participation Fund

The concept of State Participation as it applies to water supply projects is as follows. A local area, such as Bosque County or individual entities, needs an additional water source, transmission pipelines, storage reservoir, and treatment plant to meet present and future water supply needs. The area's existing customer base can only support monthly rates required to repay loans for a project sized to meet present needs. However, if a project is built to only meet present needs, it may soon be inadequate. Thus, through the State Participation Fund, the local entity could plan a larger project, with phased construction of the separate elements to the extent possible, and apply to the TWDB for state participation in the project. Under this arrangement, the TWDB would become a "silent partner" in the project by entering into an agreement with the local entity to pay up to half of the project costs initially. The TWDB would hold the remaining

SECTION 5 - RECOMMENDED ALTERNATIVE AND IMPLEMENTATION PLAN

project share until a future date, at which time the local entity would be required to buy the TWDB's share.

The terms and conditions of such an agreement are negotiated for each case. Typically, local entities are required to pay simple interest on the TWDB's share of the project cost from the beginning and to begin buying the TWDB's share, including accumulated interest, at a specified future date, usually within 8 to 12 years of project completion. By lending the state's credit to local areas, an optimal development plan for growing areas can be implemented at lower costs. However, the local beneficiaries of the program will be required to repay the TWDB, including interest and financing costs incurred. It is emphasized, however, the state participation fund is appropriate and reasonable only for additional project capacities that will be needed within the foreseeable future.

5.4.4 Community Development Block Grants

The Community Development Block Grant (CDBG) program was created by Congress in 1974. It is administered at the federal level through the U.S. Department of Housing and Urban Development (HUD). The program is divided into two major categories: (1) entitlement (cities over 50,000 and qualifying counties over 200,000 in population) and (2) non-entitlement (cities under 50,000 in population and counties not eligible for entitlement status). In the State of Texas, there are 47 entitlement cities, 5 entitlement counties, and approximately 1,313 non-entitlement cities and counties. Entitlement cities receive an annual allocation of funds directly from HUD for eligible activities, whereas non-entitlement localities generally have to compete on a statewide basis for funding.

In 1981, Congress transferred the responsibilities of administering several federal block grant programs to the states. This law authorized the states to administer the non-entitlement portion of the CDBG program. The State of Texas assumed administration of this program in federal fiscal year 1983. It is administered by the Texas Department of Housing and Community Development. The Texas Community Development Program provides grants and loans on a competitive basis to non-entitlement cities in Texas. Thus, an application for such funding would need to be made by Clifton or Meridian for a relevant part of the regional water supply plan. Among the threshold requirements of applicants, there must be a particular problem that

SECTION 5 - RECOMMENDED ALTERNATIVE AND IMPLEMENTATION PLAN

poses a serious and immediate threat to the health and safety of the public and the applicant must have the ability to levy a local property tax and/or local sales tax.

The Community Development Fund is the major funding category (about two-thirds of the total funding) under the Texas Community Development Program, and is the only category through which water supply projects for Clifton and Meridian could be eligible. Typical types of public works projects requested and funded include water and sewer improvements, street and drainage improvements, community and senior centers, and handicapped accessibility projects. An annual competition, divided into regional allocations for eligible cities and counties in each of the state's 24 planning regions, is held. An application for the 1996 program would need to be filed with the Heart of Texas Council of Governments. The notice for application and schedule for filing will be announced in September or October of 1995 for the 1996 competition. The applications are reviewed by Texas Department of Housing and Community Development staff, and the Heart of Texas Council of Governments regional advisory committee. The committee, which is comprised of 12 locally elected officials appointed by the Governor for two-year terms of office, would meet publicly to review and score applications in accordance with previously established scoring criteria. Award recommendations are made to the Department of Housing and Community Development's Executive Director on the basis of scores of the regional review committee. The Executive Director makes final funding decisions on the basis of these recommendations.

5.4.5 Rural Economic and Community Development (RECD) Grants and Loans

The Rural Economic and Community Development Administration (formerly known as the Farmer's Home Administration) of the U.S. Department of Agriculture is authorized to provide financial assistance, in the forms of loans and grants, for water supply development in rural areas and towns with populations of 10,000 or less. Public entities, including cities, special purpose districts, and nonprofit corporations, are eligible for such assistance to restore a deteriorating water supply or to enlarge an inadequate system. Preference is given to entities in areas smaller than 5,500 people, to areas wanting to merge small facilities, and to serve low-income communities. To qualify for RECD financing, applicants must: (1) be unable to obtain

SECTION 5 - RECOMMENDED ALTERNATIVE AND IMPLEMENTATION PLAN

funds elsewhere at reasonable rates and terms, (2) have legal authority to borrow and repay loans and operate water facilities, and (3) have a financially sound project based on revenues, fees, taxes, or other sources of income. Water systems must be consistent with state water development plans and comply with all local, state, and federal laws.

Funds from RECD for water systems may be used for construction or modification of facilities such as reservoirs, pipelines, wells, and pump stations; acquisition of water rights or water supplies; legal and engineering fees required for the project; rights-of-way and easements; and relocations of roads and utilities. RECD funds may be used in conjunction with funds from other sources, such as loans from the Texas Water Development Fund or bonds sold on the open market.

The maximum length or term for RECD loans is 40 years, the statutory limitations of the organization borrowing funds, or the useful life of the project, whichever is less. Interest rates are set periodically, in accordance with the law, and as of July, 1995, rates were 5.75 percent.

Grants may be made for up to 75 percent of eligible project costs for facilities serving low-income areas. RECD staff will advise applicants as to how to assemble information and file both grant and loan applications. Such applications are filed with the local RECD district office, which for Bosque County is located in Waco, Texas. Preapplications to the district office are reviewed by the local area Council of Governments, and upon favorable review, a formal application together with an environmental assessment is filed through the local district office to the state office in Temple, Texas. Preapplication conferences with RECD staff are recommended to obtain specific details about making application for funds.

The RECD grants and loan programs appears to be a viable financing option for water supply facilities needed in the immediate future for Clifton and Meridian. This source of funding could perhaps be combined with the Texas Water Development Board funding, to secure a surface water supply for Clifton and Meridian.

REFERENCES

- Brazos River Authority (BRA), "Intensive Survey of the North Bosque River (Segment 1226)," April, 1994.
- Camp Dresser & McKee, Inc. (CDM), "Clifton Surface Water Supply Feasibility Study," City of Clifton, January, 1986.
- Carter & Burgess (C&B), "Bosque County Regional Water Supply Study," City of Clifton, City of Meridian, Texas Water Development Board, March, 1990.
- HDR Engineering, Inc. (HDR), "Analysis of Project Alternatives for Proposed Lake Bosque Project," Brazos River Authority, September, 1987.
- HDR, "Reservoir Operation Studies for Proposed Lake Bosque Project & Lake Waco Enlargement," Brazos River Authority, October, 1988.
- HDR, "Trans-Texas Water Program, West Central Study Area," Phase I, Study Report, Volume 2, May, 1994.
- Henningson, Durham & Richardson (HDR), "Water Supply Alternatives for Bosque County," The County of Bosque, May, 1982.
- Texas Department of Water Resources (TDWR), "Erosion and Sedimentation by Water in Texas," Report 268, February, 1982.
- Texas Water Development Board (TWDB), "Ground-Water Resources of Part of Central Texas with Emphasis on the Antlers and Travis Peak Formations," Report 195, Volume 1, January, 1978.
- Texas Water Development Board (TWDB), "Overview of Ground-Water Resources of Bosque County, Texas, 1994.

**REGIONAL WATER CONSERVATION
AND
EMERGENCY DEMAND MANAGEMENT PLAN**

**FOR
THE CITY OF CLIFTON, TEXAS
AND
THE CITY OF MERIDIAN, TEXAS**

**Prepared By
HDR Engineering, Inc.
Austin, Texas**

August, 1995

**REGIONAL WATER CONSERVATION
AND
EMERGENCY DEMAND MANAGEMENT PLAN**

TABLE OF CONTENTS

1.0	INTRODUCTION.....	1-1
1.1	Service Area Description	1-1
1.1.1	Clifton, Texas.....	1-1
1.1.2	Meridian, Texas	1-3
1.2	Population Served	1-3
1.3	Water Supplies and Water Use.....	1-3
1.3.1	Clifton, Texas.....	1-4
1.3.2	Meridian, Texas	1-4
1.4	Wastewater Discharged	1-6
2.0	WATER CONSERVATION GOALS.....	2-1
3.0	MEASUREMENT, ACCOUNTING, AND BILLING FOR WATER DELIVERIES	3-1
4.0	WATER CONSERVATION PLAN.....	4-1
4.1	Education and Information.....	4-1
4.2	Water Conserving Plumbing Fixtures	4-2
4.3	Water Conservation Retrofit	4-3
4.4	Conservation Oriented Rate Structure.....	4-3
4.5	Universal Metering and Meter Repair	4-3
4.6	Water conserving Landscaping	4-3
4.7	Leak Detection and Repair	4-3
4.8	Recycling and Reuse	4-4
5.0	EMERGENCY DEMAND MANAGEMENT PLAN	5-1
5.1	Trigger Conditions	5-1
5.1.1	Clifton, Texas.....	5-1
5.1.2	Meridian, Texas	5-2
5.2	Emergency Demand Management Measures	5-3
5.2.1	Clifton, Texas.....	5-3
5.2.2	Meridian, Texas	5-4
5.3	Public Information and Education.....	5-5
5.4	Initiation and Termination Procedures	5-6
5.5	Implementation of Emergency Demand Management Plan	5-6
APPENDIX A	Water Saving Methods for Individuals	
APPENDIX B	Water Conservation Literature	

LIST OF TABLES

1-1 Historic and Projected Population 1-3
1-2 Historical Water Use - Clifton, Texas 1-5
1-3 Historical Water Use - Meridian, Texas 1-5
1-4 Wastewater Discharged - Clifton and Meridian, Texas 1-6
2-1 Per Capita Water Use - Clifton and Meridian, Texas 2-1

LIST OF FIGURES

Figure 1 Planning Area Map..... 1-2

1.0 INTRODUCTION

The areas to which this Water Conservation and Emergency Demand Management Plan applies are the incorporated areas of the City of Clifton and the City of Meridian (Figure 1). These areas are located within the boundaries of Bosque County and the Brazos River Basin. Both cities obtain their water supplies from the Travis Peak Formation of the Trinity Group Aquifer, and in response to declining aquifer levels are in need of additional water supplies and a water conservation plan. In 1982 both Clifton and Meridian joined with six other entities in the Brazos River Authority (BRA)'s Lake Bosque Project. Water rights permits for Lake Bosque were issued in 1991, however implementation difficulties were encountered and in 1994, an agreement ("Windup Agreement") was executed between the Lake Bosque Project parties and the BRA that essentially terminated the Lake Bosque project. As part of the agreement, the entities in Bosque County, which includes the City of Clifton and the City of Meridian, may apply for 3,340 acre-feet of water per year from the Bosque River watershed which will be considered prior in right and superior to the rights in Lake Waco. With the termination of the Lake Bosque Project, the City of Clifton and the City of Meridian presently do not have a water supply plan to meet their needs, which is especially important given the present groundwater supply. Thus, the development of this water conservation plan to assist in meeting the water supply needs of the cities of Clifton and Meridian. Each participating city is more fully described below.

1.1 Service Area Description

1.1.1 Clifton, Texas

The City of Clifton is the largest municipality of Bosque County, with a population of 3,195 in 1990, and 3,360 in 1994. The city was incorporated on July 10, 1902 (Deed of Record, Volume 42, Page 200, Deed of Records of Bosque County, Texas). Clifton's per capita income in 1989 was \$10,582, only 72 percent of that of Texas. Clifton holds Texas Natural Resource Conservation Commission (TNRCC) Certificate of Necessity and Convenience No. 11054 dated November 1, 1979.

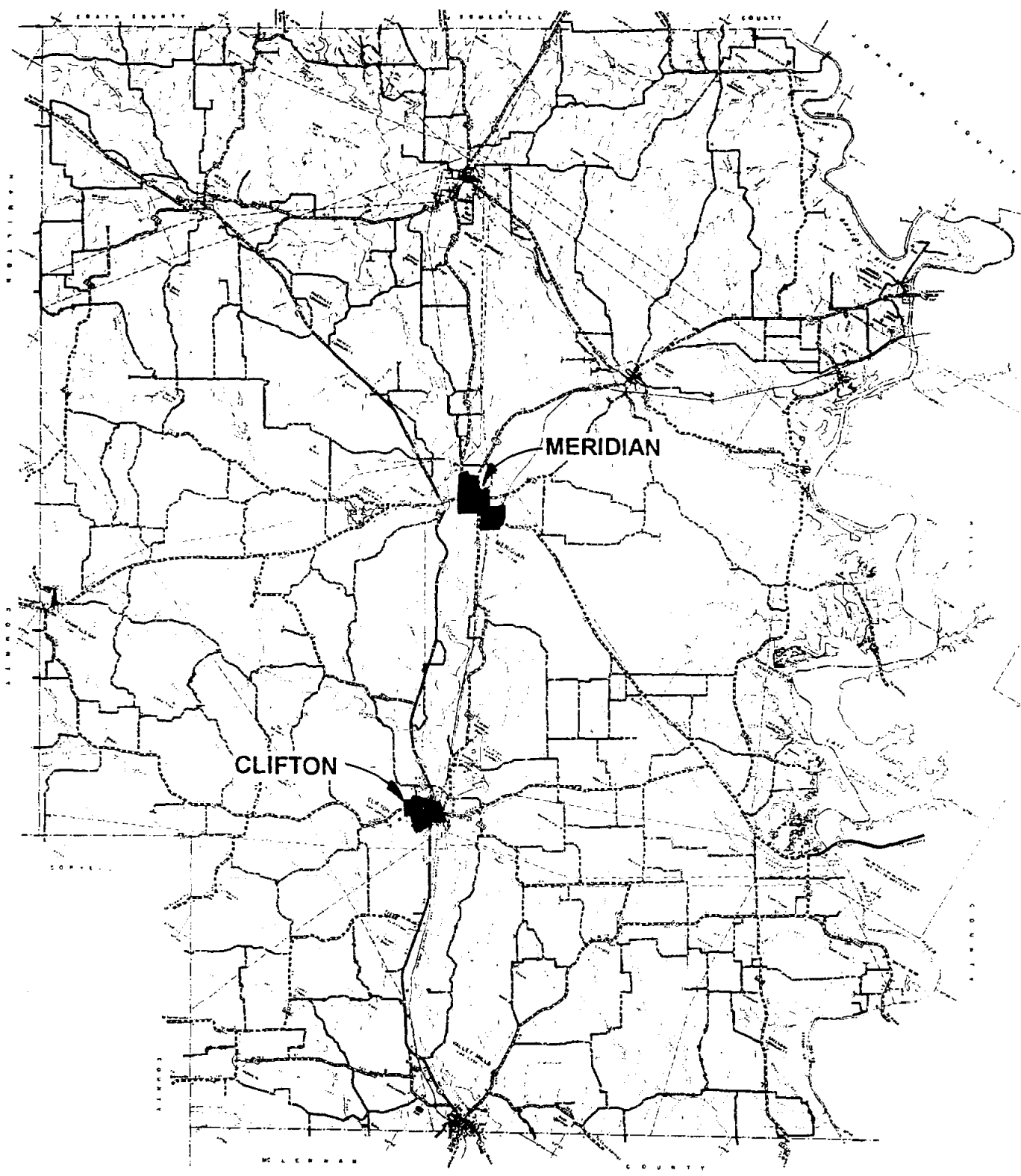

CLIFTON

MERIDIAN

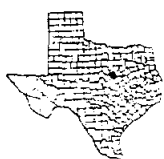

■ Planning Area

FIGURE 1
PLANNING AREA MAP

1.1.2 Meridian, Texas

Meridian is the County Seat of Bosque County, and in 1990 had a population of 1,390. Meridian's charter is dated July 20, 1886 (Deed of Record, Volume 5, Pages 168 and 169, Deed of Records of Bosque County, Texas). Meridian's per capita income is \$8,990, or 62 percent of the State average. Meridian holds Texas Natural Resource Conservation Commission Certificate of Convenience and Necessity No. 10884.

1.2 Population Served

The population of Clifton increased from 2,335 in 1960 to 3,195 in 1990, and is projected to grow to 5,340 in 2050 (Table 1-1). The population of Meridian was 993 in 1960, 1,390 in 1990 and is projected to be 2,379 in 2050 (Table 1-1).

Year	Population				
	Growth Rate (%)		Population (Number People)		
	Clifton	Meridian	Clifton	Meridian	Total
1960	0.99	1.58	2,335	993	3,328
1970	1.74	1.36	2,578	1,162	3,740
1980	0.42	0.44	3,063	1,330	4,393
1990	1.08	0.90	3,195	1,390	4,585
1995	1.08	0.90	3,371	1,453	4,824
2000	1.08	0.90	3,557	1,520	5,077
2005	1.08	0.90	3,754	1,590	5,344
2010	0.75	0.90	3,961	1,662	5,623
2015	0.75	0.90	4,111	1,738	5,849
2020	0.75	0.90	4,268	1,818	6,086
2030	0.75	0.90	4,599	1,989	6,588
2040	0.75	0.90	4,956	2,175	7,131
2050	--	--	5,340	2,379	7,719

1.3 Water Supplies and Water Use

The source of water for both the City of Clifton and the City of Meridian is the Travis Peak Formation of the Trinity Group Aquifer with the principal producing zones being the Hensel and Hosston Sand Members. The aquifer extends across a vast area of Central Texas and is the principal source of water for a large portion of this area. However, the water table is declining, thus the need for water conservation and water supply plans. Planning will include an evaluation of alternatives for developing a cost-effective surface water supply to supplement the

present ground water supplies of the City of Clifton and the City of Meridian. Each city's current supply is described below.

1.3.1 Clifton, Texas

Clifton is currently supplied by five water wells, all completed in the Travis Peak Formation. Groundwater in the Clifton area occurs in most of their wells under confined (artesian) conditions and water in wells will generally rise above the water-bearing strata of the aquifer. In the early 1960's, well levels were at about 600 feet above mean sea-level or about 65 feet below the land surface at the city's well located at the northeast edge of the city. Records indicate that well levels have steadily declined in all five of the wells. Well levels declined about 3 to 4 feet annually in the 1960's and early 1970's, however, since then well level decline has accelerated to current rates of about 10 to 20 feet annually. Recent measurements show that water levels in the City of Clifton wells are nearing the top of the aquifer and de-watering of the Hensell Sands may have occurred in some wells. Projections of future well levels show that pumping levels will likely fall below the top of the aquifer within three to five years. Well levels below the top of the aquifer is an undesirable situation resulting in de-watering of the producing zones, decreasing well yields, and increased pumping costs.

Annual water use by Clifton, during the period 1980 through 1993 has ranged from a low of 403 acre-feet in 1991 to a high of 610 acre-feet in 1993 (Table 1-2).

1.3.2 Meridian, Texas

Meridian is currently supplied by three water wells, all completed in the Travis Peak Formation. Groundwater in the Meridian area is similar to conditions in the Clifton area. Since 1960, well levels in the vicinity of Meridian have declined at a steady rate of about four to six feet annually. Records show that the pumping level in one of the city's wells was at about 90 feet above the top of the aquifer. Projections of future well levels based on current rates of well level decline show that pumping levels will likely fall below the top of the aquifer in 15 to 20 years.

For the period 1980 through 1993, annual water use by Meridian has ranged from a low of 202 acre-feet in 1980 to a high of 316 acre-feet in 1982 (Table 1-3).

Table 1-2	
Historical Water Use -- Clifton, Texas*	
Year	Annual Use (acre-feet)
1980	584
1981	479
1982	485
1983	515
1984	598
1985	527
1986	494
1987	480
1988	492
1989	463
1990	498
1991	403
1992	471
1993	610

*As reported to the Texas Water Development Board.

Table 1-3	
Historical Water Use -- Meridian, Texas*	
Year	Annual Use (acre-feet)
1980	202
1981	356
1982	316
1983	239
1984	274
1985	254
1986	268
1987	242
1988	267
1989	250
1990	242
1991	235
1992	243
1993	273

*As reported to the Texas Water Development Board.

1.4 Wastewater Discharges

The quantities of wastewater that have been treated and discharged by each of the cities of Clifton and Meridian are listed in Table 1-4. For Clifton, average daily wastewater discharges have been in the 0.20 to 0.31 mgd during the past five years (Table 1-4). For Meridian the range has been 0.16 to 0.18 mgd (Table 1-4).

Year	Wastewater Discharged (mgd)	
	Clifton	Meridian
1989	0.137	0.174
1990	0.310	0.159
1991	0.229	0.166
1992	0.220	0.178
1993	0.206	0.168
1994	0.267	0.175

2.0 WATER CONSERVATION GOALS

A major water conservation objective is to increase water use efficiency without adversely affecting population and economic growth potentials. The general methods available to accomplish this objective are through public education, the use of low flow plumbing fixtures, and water conservation rates. A measure of water use efficiency is the per capita water use of the area being served. The water conservation goals of Clifton and Meridian, as expressed in terms of per capita water use are to reduce per capita water use of present levels of approximately 160 gallons per person per day to 155 gallons per person per day in 2005 and to 150 gallons per person per day in 2015 (Table 2-1).

Year	Water Use (gpcd)*	
	Clifton	Meridian
1980	197	138
1990	138	150
1995	160	160
2000	157	157
2005	155	155
2010	152	152
2015	150	150
2020	150	150
2030	150	150
2040	150	150
2050	150	150

*Gallons per person per day.

3.0 MEASUREMENT, ACCOUNTING, AND BILLING FOR WATER DELIVERIES

Both the City of Clifton and the City of Meridian meter water deliveries to each customer. The City of Clifton has an increasing block rate structure. Residential customers pay a \$15.00 minimum for the first 3,000 gallons, \$1.75/1,000 gallons for use between 3,000 and 10,000 gallons, and \$2.00/1,000 gallons for use in excess of 10,000 gallons. Commercial rates include a \$17.50 minimum for the first 2,000 gallons, \$2.00/1,000 gallons for use between 2,000 and 10,000 gallons, and \$2.25/1,000 gallons for use in excess of 10,000 gallons.

The City has recently replaced most water meters, and is presently considering the potential benefits of a retrofit program to reduce water consumption by existing customers.

The City of Meridian utilizes an increasing block rate structure, which has been in place since 1984. Residential and commercial rates include a minimum charge of \$11.50 for the first 3,000 gallons and a charge of \$1.55/1,000 gallons up to 10,000 gallons. For 10,000 to 20,000 gallons, the unit water rate is \$2.25/1,000 gallons. This rate increases to \$2.75/1,000 gallons for use in excess of 20,000 gallons.

Meridian has a leak detection program that consists of computer flagging of unusually high water consumption and active cooperation with the police department in timely location of leaks. Water meters are replaced on an as needed basis.

4.0 WATER CONSERVATION PLAN

The water conservation plan for Clifton and Meridian includes the water conservation methods specified in the Texas Water code, as follows¹:

- (1) Education and information;
- (2) Water Conserving Plumbing Fixtures;
- (3) Retrofit programs;
- (4) Conservation oriented rate structure;
- (5) Universal metering and meter repair;
- (6) Water Conservation Landscaping;
- (7) Leak Detection and Repair; and
- (8) Recycling and Reuse.

Each method is described below.

4.1 Education and Information

Each city's water utility develop and operate a water conservation education and information program which includes the following actions, as appropriate and applicable:

- Provide qualified individuals to speak at institutions, organizations, and groups throughout the area at regular intervals;
- Conduct or sponsor exhibits on conservation, water saving devices, and other methods to promote water conservation and efficiency;
- Provide and distribute brochures and other materials to area citizens. Materials are available from the Texas Agricultural Extension Service and the TWDB;
- Work in cooperation with builders, developers, and governmental agencies to provide exhibits of xeriscape landscaping;
- Work in cooperation with schools to establish an education program, and provide conservation videos, brochures, and teaching aids; and
- Develop welcome packages for new citizens to educate and provide the benefits of conservation and availability of native, water efficient plants, trees, shrubs, and grasses.

Water saving methods for individuals will be communicated to the public (Appendices A and B).

¹ V.T.C.A., Water Code, Section 17.125.

4.2 Water Conserving Plumbing Fixtures

In 1991, the Texas Legislature enacted legislation (Senate Bill 587) which established minimum standards for plumbing fixtures sold within Texas.² The bill became effective on January 1, 1992 and allowed until January 1, 1993 for wholesalers and retailers to clear existing inventories of pre-standards plumbing fixtures. The standards for new plumbing fixtures, as specified by Senate Bill 587, are as follows:

<u>Fixture</u>	<u>Standard</u>
Wall Mounted Flushometer Toilets	2.00 gallons per flush
All Other Toilets	1.60 gallons per flush
Shower Heads	2.75 gallons per minute at 80 psi*
Urinals.....	1.00 gallons per flush
Faucet Aerators	2.20 gallons per minute at 80 psi*
Drinking Water Fountains.....	Shall be self-closing

*pounds per square inch

The TNRCC has promulgated rules requiring the labeling of both plumbing fixtures and water using appliances sold in Texas. The labels must specify the rates of flow for plumbing fixtures and lawn sprinklers, and the amounts of water used per cycle for clothes washers and dishwashers.³

The TWDB estimated that the installation of the new plumbing fixtures in dwellings, offices, and public places can reduce per capita water use by about 22 gallons per person per day.⁴ The estimated water conservation effect was obtained as follows:

<u>Plumbing Fixture</u>	<u>Water Savings</u> <u>(gallons per person per day)</u>
Wall Mounted Flushometer Toilets	14.0 gallons
All Other Toilets	5.5 gallons
Shower Heads	2.1 gallons
Urinals.....	0.3 gallons
Faucet Aerators	<u>0.1 gallons</u>
TOTAL	22.0 gallons

² Senate Bill 587, Texas Legislature, Regular Session, 1991, Austin, Texas.

³ Chapter 290. 30 TAC Sections 290.251, 290, 253-290.256, 290.260,290.265,290.266. Water Hygiene. Texas Register. December 24, 1993. Page 9935.

⁴ "Water Conservation Impacts on Per Capita Water Use," Unpublished Water Planning Information, Texas Water Development Board, Austin, Texas, 1994.

The above standards are enforced through requirements placed directly on the manufacturers, importers, and suppliers of new fixtures in Texas and do not necessarily require the amendment of existing plumbing codes. However, each city will include these requirements in their respective plumbing codes and inspection programs.

4.3 Water Conservation Retrofit

Retrofit of existing plumbing fixtures will be encouraged through the voluntary efforts of individual consumers for their homes and businesses. Replacement of existing plumbing fixtures with low flow fixtures will result in a reduction of water use within existing structures. Water conserving plumbing fixtures are available at local hardware stores, and can be installed by the consumers. If the voluntary approach is not satisfactory, each city will consider incentives such as rebates and/or water rate adjustments to further encourage the retrofitting of plumbing in existing structures.

4.4 Conservation Oriented Rate Structure

Each city has increasing block rates (see Section 3.0) that discourage high volumes of water use. In the future, the rates will be reviewed and adjusted as needed.

4.5 Universal Metering and Meter Repair

Water sales are fully metered within each city and a large proportion of meters have been replaced in recent years. Meter testing and repair will be done as a part of each city's regular maintenance program.

4.6 Water Conserving Landscaping

Each city's public education and information program will promote water conserving landscaping and xeriscaping to reduce summer peak demands and lower overall annual demands. Demonstration landscapes will be maintained in highly visible areas to promote these concepts.

4.7 Leak Detection and Repair

Each city includes leak detection and repair as a part of its regular operations and maintenance program. These policies will be reviewed and updated, as needed.

4.8 Recycling and Reuse

Each city will evaluate the potentials for use of treated wastewater for nonpotable uses including irrigation of parks and golf courses, and for industry. Recycling and reuse will be encouraged when it is found to be economical, and environmentally practical.

5.0 EMERGENCY DEMAND MANAGEMENT PLAN

Whereas water conservation involves the implementation of programs and practices to encourage more efficient use of available water supplies, emergency demand management planning, involves the development of criteria for the recognition of impending water supply shortages and the implementation of methods to manage severely limited water supplies during drought periods. An effective emergency demand management plan includes the key components listed below:

- Trigger Conditions;
- Emergency Demand Management Measures;
- Public Information and Education;
- Initiation and Termination Procedures; and
- Implementation of Emergency Demand Management Plan.

Each component is explained below.

5.1 Trigger Conditions

Trigger conditions for mild, moderate, severe, and critical conditions represent the various sets of circumstances under which emergency demand management measures of increasing severity must be implemented in order to most efficiently manage limited available water supplies. Trigger conditions for Clifton and Meridian are listed below.

5.1.1 Clifton

The City of Clifton will initiate appropriate emergency demand management measures upon occurrence of any one of the following trigger conditions:

- 1) Mild Conditions
 - a) Daily water demand exceeds 1,000,000 gallons or 80% of treatment or pumping capacity for 7 consecutive days.
 - b) Minimum water pressure within the distribution system remains below 30 pounds per square inch (psi) for 12 consecutive hours.
 - c) Ground or elevated storage volume remains below 70% of capacity for 2 consecutive days.
 - d) Impending or actual system component failures in conjunction with water demand exceeding 80% of reduced treatment, pumping or distribution capacity.

- 2) Moderate Conditions
 - a) Daily water demand exceeds 1,250,000 gallons or 90% of treatment or pumping capacity for 4 consecutive days.
 - b) Minimum water pressure within the distribution system remains below 30 psi for 24 consecutive hours.
 - c) Ground or elevated storage volume remains below 60% of capacity for 2 consecutive days.
 - d) Impending or actual system component failure in conjunction with water demand exceeding 90% of reduced treatment, pumping or distribution capacity.

- 3) Severe Conditions
 - a) Daily water demand exceeds 1,500,000 gallons or 100% of treatment or pumping capacity for 3 consecutive days.
 - b) Minimum water pressure within the distribution system remains below 30 psi for 36 consecutive hours.
 - c) Ground or elevated storage volume remains below 50% of capacity for 2 consecutive days.
 - d) Impending or actual system component failure in conjunction with water demand exceeding 100% of reduced treatment, pumping, or distribution capacity.
 - e) Imminent failure of one or more water system components where immediate health or safety hazards may result.

- 4) Critical Conditions
 - a) Failure of one or more water system components resulting in immediate health or safety hazards.
 - b) Contamination of water supply or other disaster.

5.1.2 Meridian

The City of Meridian will initiate appropriate emergency demand management measures upon occurrence of any one of the following trigger conditions:

- 1) Mild Conditions
 - a) Daily water demand exceeds 748,000 gallons or 80% of treatment or pumping capacity for 5 consecutive days.
 - b) Ground or elevated storage volume remains below 80% of capacity for 5 consecutive days.
 - c) Impending or actual system component failure in conjunction with water demand exceeding 90% of reduced treatment, pumping or distribution capacity.

- 2) **Moderate Conditions**
 - a) Daily water demand exceeds 842,400 gallons or 90% of treatment or pumping capacity for 5 consecutive days.
 - b) Ground or elevated storage volume remains below 80% of capacity for 5 consecutive days.
 - c) Impending or actual system component failure in conjunction with water demand exceeding 90% of reduced treatment, pumping or distribution capacity.

- 3) **Severe Conditions**
 - a) Daily water demand exceeds 936,000 gallons or 100% of treatment or pumping capacity for 2 consecutive days.
 - b) Ground or elevated storage volume remains below 70% of capacity for 2 consecutive days.
 - c) Impending or actual system component failure in conjunction with water demand exceeding 100% of reduced treatment, pumping, or distribution capacity.
 - d) Imminent failure of one or more water system components where immediate health or safety hazards may result.

- 4) **Critical Conditions**
 - a) Failure of one or more water system components resulting in immediate health or safety hazards.
 - b) Contamination of water supply or other disaster.

5.2 Emergency Demand Management Measures

Emergency demand management measures for mild, moderate, severe, and critical conditions represent the various responses to the occurrence of defined trigger conditions of increasing severity which will be implemented in order to most efficiently manage limited available water supplies. The specific emergency demand management measures defining the appropriate responsibilities for Clifton and Meridian are listed below.

5.2.1 Clifton

The City of Clifton will implement the following emergency demand management measures upon occurrence of the defined trigger conditions:

- 1) **Mild Conditions:**
 - a) Inform the public through the news media that a mild trigger condition has occurred and encourage voluntary water use reductions.
 - b) Activate an information center and utilize the news media to distribute information on water conservation methods and on the Emergency Demand Management Plan adopted by the City.
 - c) Publicize a voluntary odd/even lawn watering schedule such that customers with odd numbered calendar dates. Recommend lawn watering only between the hours of 6-10 a.m. and 7-11 p.m.

- 2) Moderate Conditions:
 - a) Inform the public through individual mailings and the news media that a moderate trigger condition has occurred and include a detailed description of voluntary/mandatory emergency demand management measures along with associated fines and enforcement procedures.
 - b) Implement a mandatory 5-day lawn watering schedule based on the last digit of the street address. Customers with street addresses ending in 0 or 9 may water the first day, 1 and 8 the second day, 2 and 7 the third day, etc. Lawn watering will be allowed only between the hours of 6-10 a.m. and 7-11 p.m.
 - c) Request a voluntary reduction of 20% in total water usage.
 - d) Prohibit car, pavement, and window washing except when using a hand-held bucket.
 - e) Prohibit water uses which are not essential for public health or safety including, but not limited to:
 - 1) Filling of swimming pools;
 - 2) Street washing;
 - 3) Water hydrant flushing; and
 - 4) Public park and athletic field watering.

- 3) Severe Conditions:
 - a) Inform the public through individual mailings and the news media that a severe trigger condition has occurred and include a detailed description of mandatory emergency demand management measures along with associated fines and enforcement procedures.
 - b) Prohibit all outdoor water use which is not essential for public health or safety.
 - c) Require a mandatory reduction of 20% in total water usage by each customer based on usage in the same month of the previous year.
 - d) Implement a user surcharge for excessive water use based on customer type and meter size.

- 4) Critical Conditions:
 - a) Continue implementation of all relevant actions established for less severe conditions.
 - b) Arrange for supplemental water supply from alternative sources.
 - c) Ration or terminate water service to selected portions of the system or classifications of customers according to a specified priority schedule.

5.2.2 Meridian

The City of Meridian will implement the following emergency demand management measures upon occurrence of the defined trigger conditions:

- 1) Mild Conditions:
 - a) Inform the public through the news media that a mild trigger condition has occurred and encourage voluntary water use reductions.
 - b) City staff will meet to review recent water works operations and existing alternative supply capability.
 - c) Council will be informed of situation at regular meeting.

- 2) **Moderate Conditions:**
 - a) Inform the public through individual mailings and the news media that a moderate trigger condition has occurred and include a detailed description of voluntary/mandatory emergency demand management measures along with associated fines and enforcement procedures.
 - b) At regular meeting, Council will consider resolution calling for voluntary water use reductions.
 - c) Request a voluntary reduction of 25% in total water usage.
- 3) **Severe Conditions:**
 - a) Inform the public through individual mailings and the news media that a severe trigger condition has occurred and include a detailed description of mandatory emergency demand management measures along with associated fines and enforcement procedures.
 - b) Prohibit all outdoor water use which is not essential for public health or safety.
 - c) Require a mandatory reduction of 25% in total water usage by each customer based on usage in the same month of the previous year.
- 4) **Critical Conditions:**
 - a) Continue implementation of all relevant actions established for less severe conditions
 - b) Arrange for supplemental water supply from alternative sources.
 - c) Ration or terminate water service to selected customers according to a specified priority schedule.

5.3 Public Information and Education

Public information and education is the key component of an effective emergency demand management program. In order to respond to the occurrence of trigger conditions in a timely and orderly fashion, the public must fully understand the emergency demand management measures, the procedures for their implementation, and the penalties for non-compliance. Hence, the Education and Information portion of the water Conservation Program will include newspaper articles and pamphlets detailing the purpose, implementation procedures, and expected results of the Emergency Demand Management Plan.

Throughout the period during which emergency demand management measures are necessary, regular articles will appear to explain and educate the public on the water conservation methods and requirements appropriate for each condition. Relevant water usage, equipment condition and repair status, reservoir contents, and conservation effectiveness data will be reported to the news media until conditions have improved.

5.4 Initiation and Termination Procedures

It will be the responsibility of the cities to monitor the quantity and quality of water stored in the water supply sources and to provide written notification to the public when a trigger condition involving system storage or water supply contamination has occurred. A specified representative of each city will be responsible, through the various utility departments, for monitoring the status of the water supply and distribution systems and implementing emergency demand management measures as necessary. With the occurrence of a trigger condition or when the occurrence of a trigger condition appears imminent, the public will be notified through announcements on television and radio and through publication of newspaper articles. In the event of occurrence of trigger conditions requiring moderate or severe emergency demand management measures, the public will also be notified by individual mailings.

The specified representative of each city will continue to monitor the water supply status. Once emergency demand management measures for a particular condition are no longer necessary, the public will be notified immediately through the news media.

5.5 Implementation of Emergency Demand Management Plan

The Emergency Demand Management Plan will be implemented by adoption of consistent emergency demand management ordinances by each of the cities. Enforcement of the local emergency demand management measures will be the responsibility of the cities.

APPENDIX A

WATER SAVING METHODS FOR INDIVIDUALS

WATER SAVING METHODS FOR INDIVIDUALS

The TWDB provides many ideas for saving water in the home. According to the TWDB, in-home water use accounts for an average of 65 percent of total residential use, while the remaining 35 percent is used for exterior residential purposes such as lawn watering and car washing. Average residential in-home water use data indicate that about 40 percent is used for toilet flushing, 35 percent for bathing, 11 percent for kitchen uses, and 14 percent for clothes washing. Water saving methods that can be practiced by the individual water user are listed below.

BATHROOM

1. Take a shower instead of filling the bath tub for a bath. Showering usually requires less water than bathing.
2. Install low-flow shower heads which restrict the quantity of flow at 60 psi to no more than 2.75 gallons per minute.
3. Take shorter showers and install a cutoff valve, or turn the water off while soaping and back on again to rinse.
4. Avoid the use of hot water when cold will do. Water and energy can be saved by washing hands with soap and cold water, hot water can be added when hands are especially dirty.
5. Reduce the level of the water being used in a bath tub by one or two inches, if a shower is not available.
6. Turn the water off when brushing teeth until it is time to rinse.
7. Avoid running the water when washing hands. Instead, hands should be wet, the water should be turned off while soaping and scrubbing, and the water turned on again to rinse. If desired, a cutoff valve may be installed on the faucet.
8. Shampoo hair in the shower. Shampooing in the shower takes only a little more water than is used to shampoo hair during a bath, and much less than shampooing and bathing separately.
9. Hold hot water in the basin when shaving instead of letting the faucet continue to run.

10. Test toilets for leaks. To test for a leak, a few drops of food coloring can be added to the water in the tank. The toilet should not be flushed. The customer can then watch to see if the food coloring appears in the bowl within a few minutes. If it does, the fixture needs adjustment or repair.
11. Use a toilet tank displacement device. A one-gallon plastic milk bottle can be filled with stones or with water, recapped, and placed in the toilet tank. This reduces the amount of water in the tank and still provides enough for flushing. Bricks are not recommended since they eventually crumble and could damage the toilet working mechanism.
12. Install faucet aerators to reduce water consumption.
13. Avoid using the toilet to dispose of cleaning tissues, cigarette butts, or other trash. This can waste a great deal of water and also places an unnecessary load on the wastewater treatment plant, or the on-site disposal system.
14. Install a new low-volume flush toilet that uses 1.6 gallons or less per flush when building a new home or remodeling a bathroom.

KITCHEN

1. Use a pan of water (or place a stopper in the sink) for rinsing pots and pans and cooking implements when cooking rather than turning on the water faucet each time a rinse is needed.
2. Avoid running the dishwasher without a full load. In addition to saving water, detergent will last longer, and a significant energy savings will appear on the utility bill.
3. Use the sink disposal sparingly, and do not use it for just a few scraps.
4. Keep a container of drinking water in the refrigerator. Running water from the tap until it is cool is wasteful. Or save both water and energy by keeping cold water in a picnic jug on a kitchen counter to avoid opening the refrigerator door frequently.
5. Use a small pan of cold water when cleaning vegetables rather than letting the faucet run.
6. Use only a little water in the pot and put a lid on it for cooking most food. Not only does this method save water, but food is more nutritious since vitamins and minerals are not poured down the drain with the extra cooking water.

7. Use a pan of water for rinsing when hand washing dishes rather than a running faucet.
8. Always keep water conservation in mind, and think of other ways to save in the kitchen. Small kitchen savings from not making too much coffee or letting ice cubes melt in a sink can add up in a year's time.

LAUNDRY

1. Wash only a full load when using an automatic washing machine.
2. Use the lowest water level setting on the washing machine for light loads whenever possible.
3. Use cold water as often as possible to save energy, and to conserve hot water for uses which cold water cannot serve.

APPLIANCES AND PLUMBING

1. Check water requirements of various models and brands when considering purchasing any new appliance that uses water. Some appliances use less water than others.
2. Check all water line connections and faucets for leaks. If the cost of water is \$1.00 per 1,000 gallons, one could be paying a large bill for water that simply goes down the drain because of leakage. A slow drip can waste as much as 170 gallons of water EACH DAY, or 5,000 gallons per month, and can add as much as \$10.00 per month to a water bill.
3. Learn to replace faucet washers so that drips can be corrected promptly. It is easy to do, costs very little, and can represent a substantial amount of savings in plumbing and water bills.
4. Check for water leakage that may not be visible, such as a leak between the water meter and the house. To check, all indoor and outdoor faucets should be turned off, and the water meter should be checked. If it continues to run or turn, a leak probably exists and needs to be located.
5. Insulate all hot water pipes to avoid the delay (and wasted water) experienced when waiting for the water to "run hot."
6. Check the hot water heater thermostat to see that it is not set too high. Extremely hot settings waste water and energy because the water often has to be cooled with cold water before it can be used.

7. Use a moisture meter to determine when house plants need water. More plants die from overwatering than from being too dry.

OUT-OF-DOOR USES

1. Water lawns early in the morning during the hotter summer months. Much of the water used on the lawn can simply evaporate between the sprinkler and the grass.
2. Use a sprinkler that produces large drops of water, rather than a fine mist, to avoid evaporation.
3. Turn soaker hoses so the holes are on the bottom to avoid evaporation.
4. Water slowly for better adsorption, and do not water on windy days.
5. Avoid watering the street, walks, or driveways.
6. Condition the soil with compost before planting grass, or flower beds so that water will soak in rather than run off.
7. Fertilize lawns at least twice a year for root stimulation. Grass with a good root system makes better use of less water.
8. Learn to know when grass needs watering. If it has turned a dull grey-green or if footprints remain visible, it is time to water.
9. Avoid overwatering grass. Too much water can overload the soil so that air cannot get to the roots and can encourage plant diseases. Also, the soil can absorb only so much moisture and the rest simply runs off. A timer will help, and either a kitchen timer, or an alarm clock will do. An inch and one-half of water applied once a week will keep most Texas grasses alive and healthy.
10. Operate automatic sprinkler systems only when the demand on the town's water supply is lowest. Set the system to operate between four and six a.m.
11. Avoid scalping lawns when mowing during hot weather. Taller grass holds moisture better. Rather, grass should be cut fairly often, so that only 1/2 to 3/4 inch is trimmed off. A better looking lawn will result.
13. Use a watering can or hand water with the hose in small areas of the lawn that need more frequent watering (those near walks, driveways, or in especially hot, sunny spots).

14. Learn what types of grass, shrubbery, and plants do best in the area and in which parts of the lawn, and then plant accordingly. If one has a heavily shaded yard, no amount of water will make roses bloom. In especially dry sections of the state, attractive arrangements of plants that are adapted to arid, or semi-arid climates should be chosen.
15. Consider decorating areas of the lawn with rocks, gravel, wood chips, or other materials now available that require no water at all.
16. Avoid sweeping walks and driveways with the hose. Use a broom or rake instead.
17. Use a bucket of soapy water when washing the car, and use the hose for rinsing.

APPENDIX B

WATER CONSERVATION LITERATURE

Water Conservation Literature⁵

Single copies of the following publications and materials can be obtained from the Texas Water Development Board. To make a request, write: CONSERVATION, Texas Water Development Board, Capitol Station, Austin, Texas 78711-3231.

Agricultural Conservation Literature

Title	Published By ⁶	Description	Length
Agricultural Water Conservation in Texas*	TWDB	Pamphlet with Tear-out	8 pages
Have Your Irrigation Evaluated Free*	TWDB	Pamphlet	4 pages
LEPA Irrigation*	TWDB	Pamphlet	6 pages
Drip Irrigation*	TWDB	Pamphlet	6 pages
Plastic Ruler*	TWDB	6"x1-1/4"	—
Furrow Dikes*	HPUWCB #1	Pamphlet	4 pages
Soil Moisture Monitoring*	HPUWCB #1	Pamphlet	4 pages
Center Pivot Irrigation Systems L-2219*	TAEX	Pamphlet	4 pages
Surge Flow Irrigation L-2220*	TAEX	Pamphlet	4 pages
Surge Irrigation*	SCS	Pamphlet	6 pages
Coloring Poster for Children*	TWDB	Coloring Poster	1 page
Water Conservation Coloring Book* (No. 1)	TWDB	Booklet	4 pages

⁵ Source: Texas Water Development Board, Austin, Texas.

⁶ Abbreviations:

HPUWCD #1	High Plains Underground Water Conservation District No. 1
NXC	National Xeriscape Council, Inc.
SCS	USDA-Soil Conservation Service
TAEX	Texas Agricultural Extension Service
TDA	Texas Department of Water Resources
TDWR	Texas Department of Water Resources
TWDB	Texas Water Development Board

Municipal Conservation Literature

Title	Published By	Description	Length
Water Half-A-Hundred Ways to Save It*	TWDB	Pamphlet	8 pages
Water Saving Ideas for Business and Industry*	TWDB	Pamphlet	8 pages
How to Save Water Outside The Home*	TWDB	Pamphlet	8 pages
Toilet Tank Leak Detector Tablets*	TWDB	Pamphlet	--
Municipal & Commercial Water Conservation Services	TWDB	Pamphlet with Tear-out	8 pages
A Homeowner's Guide to Water Use and Water Conservation	TWDB	Booklet	22 pages
Guidelines for Municipal Water Conservation and Drought Contingency Planning and Program Development	TWDB	Loose-leaf	36 pages
How to Xeriscape	NXC	Pamphlet	10 pages
Texas Sesquicentennial Native Plant Landscape	TDA/TWDB	Pamphlet	8 pages
Municipal Water Conservation Workshop Notebook	TWDB	Notebook	6 sections
Water Conservation Coloring Book* (No. 2)	TWDB	Booklet	4 pages

Texas Water Resources and Planning Literature

Title	Published By	Description	Length
TWDB Report 294 - Surveys of Irrigation in Texas	TWDB	Book	243 pages
Summary of Water for Texas (C-20)	TWDR	Pamphlet	8 pages
Water Planning in Texas	TDWR	Booklet	27 pages

Title	Published By	Description	Length
Texas Water Development Board (Funding Programs)	TWDB	Pamphlet	4 pages
Water for Texas (GP-4-1) Volume 1 (Comprehensive Plan) Volume 2 (Technical Appendix)	TWDR	Books (Available for purchase only from the Texas Water Commission P. O. Box 13087 Austin, Texas 78711)	72 pages 530 pages
Texas Water Facts	TWDR	Booklet	12 pages

The following water conservation publications and audiovisual materials are available for a loan of up to two weeks from TWDB.⁷ To borrow any of these write to: CONSERVATION, Texas Water Development Board, Capitol Station, Austin, Texas 78711-3231.

Publications

<u>Title</u>	<u>Published By</u>	<u>Description</u>	<u>Length</u>
Water Audit and Leak Detection Guidebook	California Dept. of Water Res.	Book	142 pages
Example Brochures and Promotional Material	Compiled by TWDB	Ringbinder	32 pages
Regional Teachers Guide Supplements	California Dept. of Water Resources	Books	Nos. 1-7
<u>Audiovisual Materials</u>			
The Alternative is Conservation	Water Films	16 mm Film VCR/VHS Format	28 minutes
Water Follies	American Water Works Assoc. (AWWA)	16 mm Film VCR/VHS Format	7.5 minutes
Orangutans (Public Service Announcement)	AWWA VCR/VHS Format	16 mm Film VCR/VHS Format	30 seconds
Gooney Birds (public Service Announcement)	AWWA VCR/VHS Format	16 mm Film VCR/VHS Format	30 seconds
Spot Announcements	Lower Colorado River Authority	Audio Cassette	30 seconds

⁷The films, video cassettes, and publications are provided for review purposes only. Permission to use any of this material for print or broadcast must be obtained from the producer or publisher of the material.