

FOX CROSSING WATER DISTRICT
REGIONAL WATER STUDY

FEBRUARY 1990



Submitted to:

FOX CROSSING WATER DISTRICT
and
THE TEXAS WATER DEVELOPMENT BOARD

Prepared by:



HAYNIE & KALLMAN, INC.
800 Paloma Drive, Suite 160
Round Rock, Texas 78664
(512) 255-7861

H&K Job No. 1067-1900-68
File: ER FCWD
Revision: 02/20/90

TABLE OF CONTENTS

<u>SECTION</u>		<u>PAGE</u>
1.0	<u>INTRODUCTION</u>	1
1.1	Background	2
1.2	Citation of Authority	3
2.0	<u>EXECUTIVE SUMMARY</u>	9
2.1	Scope	9
2.2	Projected Growth	10
2.3	Existing Water Systems	11
2.4	Projected Water Demand	13
2.5	Proposed Improvements	14
2.6	Implementation Plan	15
2.7	Environmental	18
2.8	Water Conservation	18
3.0	<u>PROJECTED GROWTH</u>	20
3.1	Historic Trends	21
3.2	Growth Potential	24
3.3	Population Projection Studies	25
4.0	<u>EXISTING WATER SYSTEMS</u>	28
4.1	Water Source	28
4.2	Public Water Systems in Mills County	40
4.3	Public Water Systems Outside Mills County	46
5.0	<u>PROJECTED WATER DEMAND</u>	53
5.1	Water Use Projections	53
5.2	Design Criteria	56
6.0	<u>PROPOSED IMPROVEMENTS</u>	58
6.1	Planning Guidelines	58
6.2	Service Alternatives	59
6.3	Alternative Selection	68
6.4	Distribution System Planning	75
7.0	<u>IMPLEMENTATION PLAN</u>	77
7.1	Introduction	77
7.2	Revenue Note Projections	78
7.3	Project Implementation	79
7.4	Additional Considerations	80
7.5	Wellhead Protection	81
7.6	Non-Point Source Pollution Control	81
7.7	Water System Conservation	82
7.8	Water Resource Development	82
7.9	System Planning	83

NUMBER

PAGE

LIST OF FIGURES

1-1	Location Map	7
1-2	Planning Area Boundaries	8
3-1	Mills County - Population Projections	27
4-1	Colorado River Total Dissolved Solids (TDS), River Flow (CFS) vs. Five Year Period - 1984-88	32
4-2	San Saba River Total Dissolved Solids (TDS), River Flow (CFS) vs. Five Year Period - 1984-88	33
4-3	Watershed Boundary	38
4-4	Existing City of Goldthwaite Water System	41
4-5	TWC Adjudication of the Colorado River Basin 1981 Middle Segment	43
4-6	Location of City of Goldthwaite Water Facilities	45
5-1	Projected Mills County Water Use	54
5-2	Projected County Wide Water Use - Average Per Capita	55
6-1	Proposed Improvements to the City of Goldthwaite Water System	61
6-2	Annual Target Areas for Distribution System Improvements	74

LIST OF TABLES

2.1	Projected Improvements Estimated Cost Schedule	17
3.1	Mills County Population Records	22
3.2	TWDB and Texas State Data Center Population Records	25
4.1	Excerpt from TWDB Report 195 - Discussion on Mineral Levels in Water and Their Effect on Its Use	34
4.2	Excerpt from TWDB Report 195 - Total Dissolved Solids	35
4.3	Excerpt from Safe Drinking Water Act - Maximum Contamination Levels	36
4.4	Existing Water Systems Within Mills County, Texas	47
4.5	TDH Water Analysis Report	51
6.1	Alternative Analysis	70
6.2	Water Transmission and Distribution Improvements	71
6.3	System Production Improvements	72
6.4	Projected Improvements Estimated Cost Schedule	73
7.1	Revenue Note Projections	79
7.2	First Year Project Bond Pro Forma	80

APPENDICES

- A Water Conservation and Drought Contingency Planning
- B Environmental
- C Settlement Agreement
- D Colorado River Main Stem Water Discharge Records and
Water Quality Records
- E Colorado River Basin San Saba River at San Saba, Texas
Water Discharge Records
- F Central Texas Council of Governments Memorandum

INTRODUCTION

Fox Crossing Water District (hereinafter sometimes referred to as "FCWD" or "the District") was created in 1986 to develop and implement a plan for water resources development and protection within the District. As with most rural areas, the availability and quality of water is a key factor in the feasibility and profitability of the area's agribusiness economy. Limited groundwater reserves and undependable surface water supplies have placed a severe burden on the area's growth and development.

It is the purpose of this Study to survey the water resource conditions of the study area in order to develop a plan for the implementation of an area-wide potable water system. The alternative analysis as well as the detailed service plan can serve as a guide for the District's efforts in providing a centralized water treatment, storage and distribution system to serve the District. Recommendations for water conservation, wellhead protection and water resources development will help to insure future water availability.

1.1 Background

The Fox Crossing Water District was authorized by the Legislature of the State of Texas, pursuant to Article XVI, Section 59, of the Texas Constitution. House Bill 2487 authorized creation of Fox Crossing Water District to include Mills, San Saba, and Lampasas Counties, Texas. The confirmation election was held by the respective County Commissioners' Courts on April 5, 1986. The District was confirmed by the electorate of Mills County, Texas. The electorate of San Saba and Lampasas Counties declined the District creation, but may vote for annexation into the District at a later date. In the following text, since San Saba and Lampasas Counties declined participation, Fox Crossing Water District will be referred to only as a District serving Mills County, until such time as those Counties vote to join the District.

The District does not currently own or operate a public water system in Mills County. It is the purpose of this report to develop a plan for the District's implementation of water resources for the service area. The following citation of laws demonstrates the District's authority to plan, develop, and operate water and wastewater facilities within its service area.

1.2 Citation of Authority

Purposes of District - The Fox Crossing Water District was created in order to govern and control the surface waters, sub-surface waters and wastewaters of Mills County. The goals of the District Board of Directors have been defined as a desire to protect and develop the underground waters and runoff waters for the residents of Mills County.

(HB 2487 Section 51) - The District shall adopt and implement a program of water conservation . . . so that a water supply is made available for future uses. The creation and operation of the District is essential to accomplish the purposes of Article XVI, Section 59, of the Texas Constitution.

(Texas Water Code, Chapter 52.021) - An Underground Water District's purpose is to provide for the conservation, preservation, protection, recharging, and prevention of waste of the underground water of underground water reservoirs or their subdivisions, consistent with the objectives of Article XVI, Section 59, of the Texas Constitution.

Powers of District - (House Bill 2487, Section 29) - The District may: construct, renovate, repair, and maintain dams, spillways and related facilities; supply water for municipal, domestic, and industrial uses, power and commercial purposes, and all other uses and controls; collect, transport, process, dispose of, and control all domestic, industrial, and communal wastes whether in fluid, solid, or composite state; and conserve, preserve, protect, recharge, and prevent waste of water from the underground water reservoirs and subdivisions of underground water reservoirs in the District.

The District may prepare and adopt plans for and may purchase, construct, acquire, own, operate, maintain, repair, improve, and extend inside and outside boundaries of the District any works, improvements, facilities, projects, plants, pipelines, equipment, and appliances necessary to carry out the powers listed above. The District has the rights, powers, privileges, authority, and functions applicable to municipal utility districts provided by Chapters 52 and 54, Water Code. The District has the rights, powers, privileges, authority, and functions under Chapter 51, Water Code, to the extent necessary to carry out its duties and authority relating to underground water. If any provision of Chapters 51, 52, or 54, Water Code, conflicts or is inconsistent with this Act, this Act prevails.

The District may issue and sell bonds to acquire land and construct works, improvements, facilities, plants, pipelines, equipment, and appliances as provided by this Act. The District may also acquire easements, rights-of-way, and other property interests necessary to carry out the powers and duties provided by this Act.

Planning - (House Bill 2487, Sections 19, 46, 49) - The District may develop comprehensive plans for the most efficient use of the underground water of any underground water reservoir and for the control and prevention of waste of that underground water. The District Board may appoint or contract with a competent professional civil engineer for the District. The District may make or have made any studies necessary to carry out its powers and duties under this Act.

Construction of Improvements - (House Bill 2487, Section 33) - The District may contract with any person to construct, renovate, or repair any of its works, improvements, facilities, projects, plants, pipelines, equipment, and appliances, and from time to time, to make improvements to them.

(Texas Water Code, Chapter 51.125.) - A district may construct all works and improvements necessary: (1) for the prevention of floods; (2) for the irrigation of land in the district; (3) for the drainage of land in the district, including drainage ditches or other facilities for drainage; (4) for the construction of levees to protect the land in the district from overflow; (5) to alter land elevations when correction is needed; and (6) to supply water for municipal uses, domestic uses, power and commercial purposes, and all other beneficial uses or controls.

For the purpose of this report, the study area boundary shall consist of the 734 square mile area of Mills County. Figure 1-1 shows the general location of the County in relation to Central Texas. Figure 1-2 shows the County with its major roadways, cities, and prominent features.

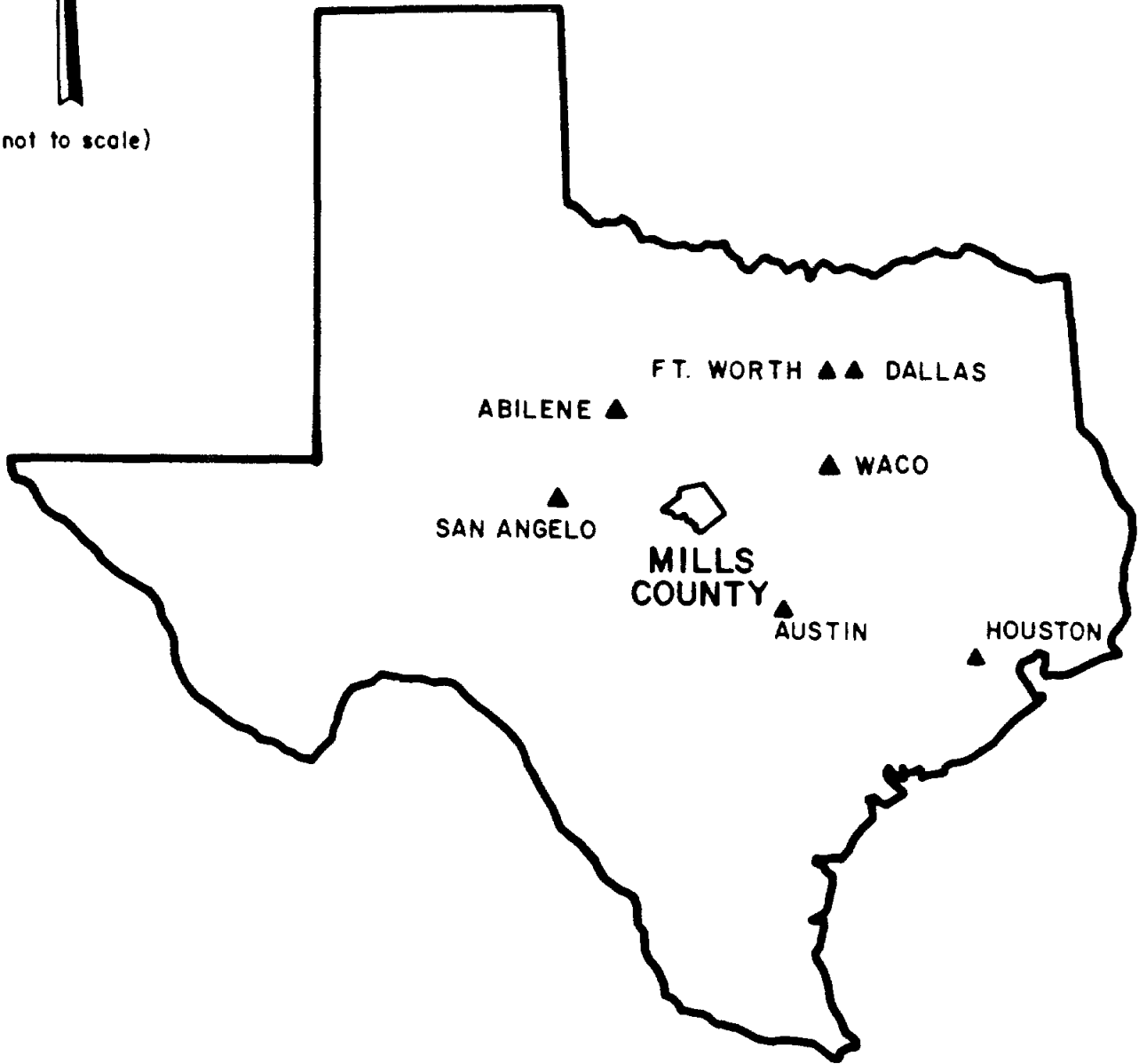
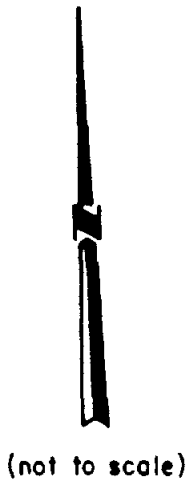

FIGURE I-1
FOX CROSSING
WATER DISTRICT
MILLS COUNTY, TEXAS
LOCATION MAP
Haynie & Kallman, Inc.

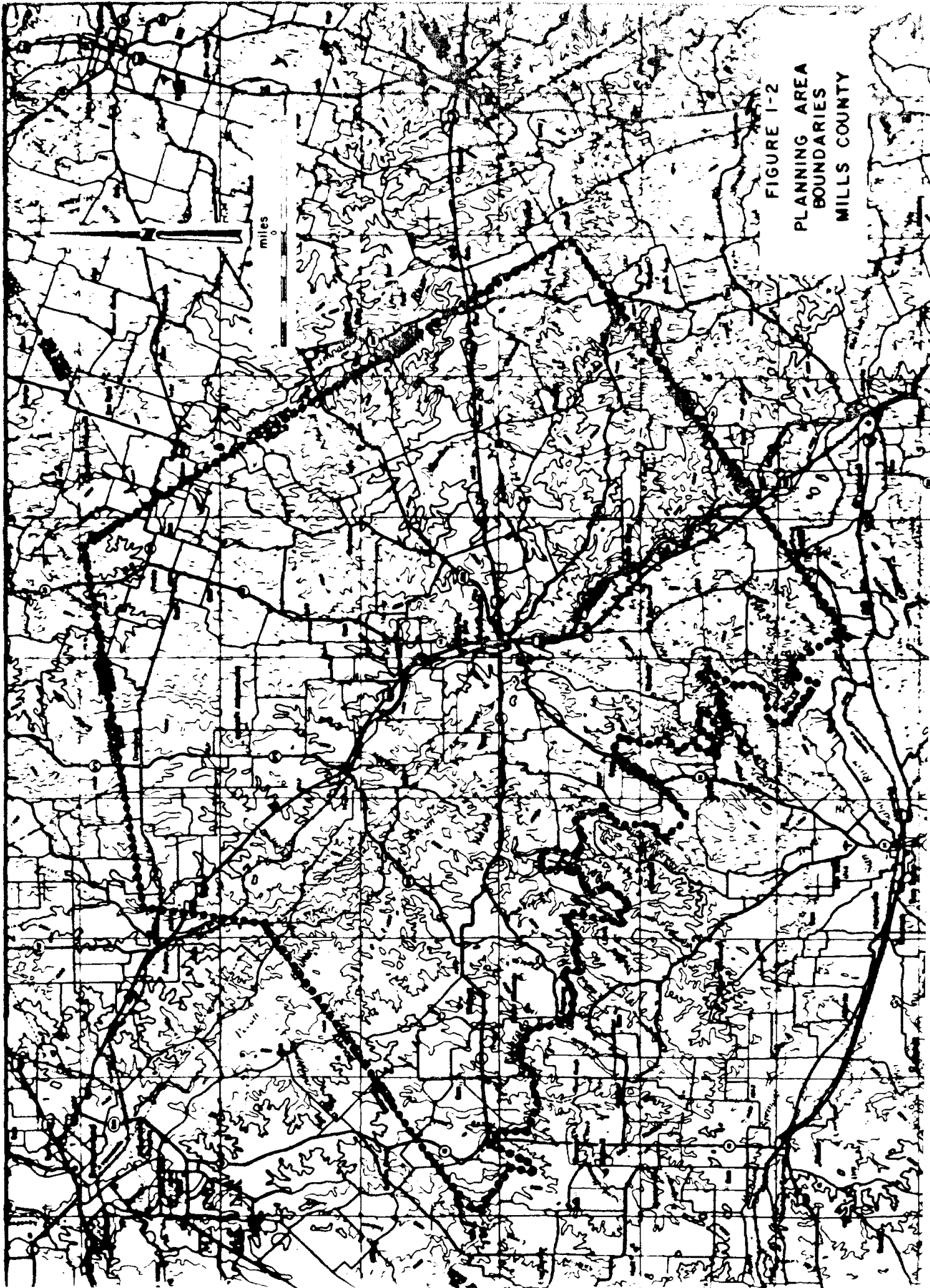

FIGURE 1-2
PLANNING AREA
BOUNDARIES
MILLS COUNTY

2.0 EXECUTIVE SUMMARY

2.1 Scope

The Fox Crossing Water District was created by the State Legislature in 1986 to develop and implement plans for water resource development and protection within the District. Water plays a critical role in the agribusiness economy of the area. The limited groundwater potential has placed severe burdens on the area's past growth and development.

The District, as originally created by legislation, included Mills, San Saba and Lampasas Counties. The election to confirm the creation of the District was only considered and approved in Mills County. San Saba and Lampasas Counties declined creation in 1986 and to date have declined participation in the program. The District does not currently own or operate a public water system or water resources project within Mills County. It is the purpose of this Study to develop a plan for the District's implementation of water resources for the service area. The District has been granted sufficient authority by the legislation that created it to plan, fund, operate and manage water development projects within its Study Area.

2.2 Projected Growth

Historically, Mills County's population has gone through a severe decline from its peak population in 1910 of 9,694 to a low population in 1970 of 4,212. Since that time the population has gradually increased to a 1980 census population of 4,477. This decline in population was due to the downturn in the area's agribusiness environment as well as the changing life-style of rural America. It is quite likely that the lack of adequate water for agriculture and commerce has also lead to this downturn in the County's population. Population projections have been developed by the Texas Water Development Board (TWDB) in their water planning studies for the State. The following table shows the Texas Water Development Board's projections for Mills County. While the population projection growth rate is low, it shows a positive and steady upward trend. These projections will need to be monitored and updated regularly to reflect the changing conditions of the area. The development of a regional water system for the area should add significant growth potential to the area.

MILLS COUNTY POPULATION PROJECTIONS

<u>Year</u>	<u>Projection</u>	<u>Annual % Growth</u>
1980	4,477	----
1985	4,527	0.22%
1990	4,586	0.26%
2000	4,911	0.69%
2010	5,138	0.45%
2020	5,295	0.30%
2030	5,429	0.30%
2040	5,496	0.25%

2.3 Existing Water Systems

Within Mills County, the largest public water system is that for the City of Goldthwaite. It obtains water from the Colorado River and stores water in two (2) off-line holding ponds. The water is then pumped to the water treatment plant. The treatment plant is rated at 600 GPM or 1000 connections capacity. The next largest public water system is that for the City of Priddy in the northern portion of the County. Here groundwater is used to provide water for the City. The City of Goldthwaite currently has approximately 900 customers; the City of Priddy has approximately 100 customers.

Other systems within Mills County are primarily small public or private individual groundwater wells in the area. Some individual systems also use water from the Colorado River in off-line holding ponds and private treatment facilities for service.

The Colorado River forms the western boundary for Mills County. It has a history of low flow conditions during dry weather and a tendency to contain high total dissolved solids or salt levels during these low flows, making the water often unpalatable. Groundwater reserves in the County are sporadic and sparse. Development of the Mills County groundwater reserves for a community or regional system does not appear reasonable.

Several of the surrounding counties have developed their own water systems. To the northeast, Lake Proctor provides adequate water for Comanche and Hamilton Counties, as well as the area's available natural groundwater reserves. In Brown County, Lake Brownwood is owned and operated by Brown County WCID No. 1, which wholesales water to several retail customers in the area. The District's charters are to provide water within Brown County and it is not feasible to obtain water for Mills County from this area.

West of Mills County, San Saba and surrounding counties obtain their water from the Hickory Aquifer. The large groundwater formation has sufficient reserves and supplies to serve a large service area. However, recent investigations by State Health Department and the Hickory Underground Water District have confirmed the presence of high radioactive levels naturally produced in the water. These levels are in excess of federal standards (Safe Water Drinking Act). Treatment of this water to remove these levels would be expensive. The estimated costs for development and treatment of a well in the Hickory is estimated in the report.

South of Mills County, the Lometa Water Supply Corporation obtains water from Lake Stillhouse Hollow through a

contract with the Brazos River Authority. Portions of their systems extend into the border area of Mills and Lampasas Counties. To get water into Mills County, their entire system would need to be upgraded in order to transfer water through the existing system. Further, the transfer of water from the Brazos River to the Colorado River watersheds would require regulatory approval. This option would appear both expensive and time-consuming. The most logical source for development appears to be the use of the City of Goldthwaite's diversion and off-line storage from the Colorado River, reinforced with a future second raw water diversion source on the San Saba River. The San Saba River offers higher quality and more consistent flow patterns. This option appears to offer sufficient water quantity and quality for the development of a county-wide water system.

2.4 Projected Water Demand

Based on the population projections summarized earlier, projected water use requirements for the County have also been developed by the TWDB. The projections show a maximum water use in the area of approximately 1,000 acre/feet per year. Presently, the City of Goldthwaite has a water diversion contract with the State of Texas for 1,500 acre/feet per year of water to be diverted from the

Colorado River. It would appear, based on the County population projections, that this contract should be adequate to assist in the development of water resources for Mills County.

2.5 Proposed Improvements

The proposed plan to develop water for Mills County would include the joint usage by the District of the City of Goldthwaite raw water diversion from the Colorado River. It would connect with the existing City of Goldthwaite raw water holding pond system presently in place. The pump stations at each of the City of Goldthwaite's existing surface water reservoirs would also be increased in size to provide additional firm pumping capacity. The City's water treatment plant currently nearing capacity at 600 gallons per minute would be expanded for an additional 300 gallons per minute of capacity. This would provide service for an additional 500 customers. From the water treatment plant, water service lines would first be run toward the City of Mullen where a higher number of potential customers could be added to the system. Each year after that, additional facilities would be constructed to provide service to the County. Initial service has been directed to the western half of Mills County where water needs are the greatest. Annual construction expenditure must be balanced with the ability to fund the necessary improvements.

2.6

Implementation Plan

The attached table shows the annual cost for construction of the above system-wide improvements. Due to the sparse nature of the population and the long distance that must be covered to connect the system, the projected costs reflect a high cost-per-connection capital cost. This range of approximately \$15,000 to \$20,000 per connection requires that both grant as well as revenue funding be used to construct the necessary improvements. The District has requested that the proposed improvements be financed on a usage rate basis and that area-wide taxation not be used. This will limit the amount of debt which can be constructed for the necessary improvements. Potential sources of grant money include the Federal Farmer's Home Administration and the Texas Department of Commerce. Revenue funding could be sold on the general market as well as possible assistance through the Texas Water Development Board.

There are additional programs that merit consideration in the development of a regionalized water system for Mills County. These would include the education of the area residents on the benefit and necessity of water protection for the area. Possible programs that should be considered would include a nonpoint source pollution program to

assess and monitor the effects of nonpoint source pollution in the County. A second area would include a wellhead protection program. This would concentrate on the education of the County residents of the need to protect private and public wellhead systems to prevent groundwater contamination in the area. It could also be expanded to include the mapping, locating and capping of abandoned wells; both water, oilfield and other borings that could potentially contaminate area groundwater. Thirdly, education on water conservation of the available water resources will be further expanded in the water conservation portion of this report. Finally, work should continue with the Soil Conservation Service on the potential development of a reservoir on Pecan Bayou or other area watershed for use as a combination water resource and recreation site for the County.

TABLE 2.1

Fox Crossing Water System Implementation
Projected Improvements Estimated Cost Schedule

<u>Year</u>	<u>Waterline Costs(a)</u>	<u>Production Costs</u>	<u>Total Costs(d)</u>	<u>Service Conn.(b)</u>	<u>Cummulative Total Cost</u>	<u>Cummulative Total Conn.(c)</u>	<u>Cost/Conn. \$/Conn.(e)</u>
1	\$1,340	\$1,300	\$2,650	263	\$ 2,640	263	\$10,040
2	1,440	390	1,830	97	4,470	360	12,420
3	1,270	650	1,920	128	6,390	488	13,100
4	1,320	890	2,210	112	8,600	600	14,330
5	1,500	260	1,760	73	10,360	673	15,390
6	1,180	260	1,440	67	11,800	740	15,950
7	1,465	260	1,725	63	13,525	803	16,840
8	1,450	260	1,710	54	15,235	857	17,780

(a) Cost estimates are reflected in thousands.

(b) Service connections based on estimates from tax maps and telephone/electric utilities.

(c) Customer base assumes no growth in areas previously served.

(d) Cost estimates include 30% for contingency, engineering, legal and fiscal.

(e) Costs may decrease slightly with growth in areas served.

2.7 Environmental

A baseline survey of the area's flora, fauna and geological conditions was developed from available literature and other research efforts. Guidelines for further evaluation and compliance with existing federal and state laws are detailed. These efforts may be necessary to comply with the funding requirements of federal and state sources. Site specific investigations should be conducted on an individual project basis prior to proceeding with the engineering and construction of the various projects.

2.8 Water Conservation

Due to the ever increasing concern over regional water supplies, the aspects and importance of a water conservation program is included in this report. Key points for a recommended conservation plan and drought contingency plan are discussed. Even though the District does not presently operate a water system, development of a plan at this time is necessary for compliance with the Texas Water Development Board regional planning grant as well as incorporating into future service plans. The District should take an active role in promoting conservation of the area's decreasing water supplies

through plumbing codes, landscaping requirements, public awareness and education. The effect that a successful conservation program will have on the District's projected revenue should also be evaluated prior to implementation of such a program.

3.0

PROJECTED GROWTH

Probably the most important factor in any analysis of this type lies in accurate predictions of the future; a task surpassed in difficulty only by predictions of Texas weather. Many different factors affect growth and development within an area. These include, but are not limited to:

- Local and regional economy;
- Local development restrictions;
- Environmental constraints;
- Current housing inventory;
- Existing and proposed roadway networks;
- Proximity to employment, schools, etc.

This section describes the population forecast used in the analysis of this report. The forecast information was then used to estimate the future water needs of the Study Area.

Long-term projections contained within this Study are intended to serve as a guide only. Due to the Study Area's layout, sparse customer base distributed over a large geographical area, and changing political and economic climates, projections beyond a five or ten year

horizon would involve a great deal of speculation. It is essential, therefore, that projected water demands and system limitations be evaluated and updated on a routine basis.

3.1 Historic Trends

Mills County is a rural, agricultural community located in north-central Texas. Like many rural communities, it has been hit hard by the downturn in the agricultural economy. Cattle, sheep and goats are the primary industry with supporting industries such as hay, small grains and agricultural-related products. The economic downturn has caused rural communities to drastically change their life-style and livelihood. Many have had to move to larger communities to earn reasonable wages. A review of the County's population record over the last 80 years illustrates this point. The County's population peaked in 1910 at 9,694, then decreased steadily to a low of 4,212 in 1970. Since that time the decline has stabilized and a positive growth has resulted.

TABLE 3.1

Mills County Population Records

<u>Year</u>	<u>Population</u>
1900	7,851
1910	9,694
1920	9,019
1930	8,293
1940	7,951
1950	5,999
1960	4,467
1970	4,212
1980	4,477

An analysis of information provided in the Texas Almanac over the past twelve (12) years drives home the effect the economic downturn has had on the local economy. The 1973 reported population of Mills County was 4,400 persons. Twelve (12) years later, in 1985, the population had only grown by 100, to a total of 4,500. This represents a growth rate of only 2% for this twelve-year period. However, statistics indicate that 631 persons, or 14% of the population, was employed in 1976 while 1,075, or 24% of the population, was employed in 1988. This indicates a dramatic shift away from agriculture and toward service-related jobs. Population statistics for the county seat, Goldthwaite, also illustrate this point. While the population for the entire County only increased by 100 during the past twelve years, the City of Goldthwaite's population increased by 138, indicating a migration from rural to more urban areas.

Agricultural income in Mills County was estimated at \$12,000,000 in 1976 and \$23,000,000 in 1988; a 92% increase. When compared to the taxable value of land in Mills County however, the plight of the farmer is again evident. Taxable value was reported to be \$8,390,339 in 1976. In 1988, the taxable value of Mills County was estimated at \$358,133,670. That represents a 4,168% increase in taxable value compared to the 92% increase in agricultural income. While a good portion of this increased value may be attributable to better records, land appraisal and an increased number of businesses in the County (reported at 94 in 1988), it is evident that the revenues generated from agricultural lands have not risen proportionately with the taxable value (i.e. taxes) of the land needed to produce that income. One of the major causes of this trend is the lack of a dependable, economical source of water in the area.

Recent economic surveys have placed the median income of the City of Goldthwaite and Mills County at \$12,746. The Texas Department of Commerce has recognized the financial needs of the area with recent Community Development Board grants.

3.2 Growth Potential

Mills County has the potential for population growth within the County to continue to increase. The local economy continues to diversify creating a strong local economic base. Residential development does not seem to be hindered by development restrictions or environmental controls. There is an available housing inventory sufficient to meet the existing growth pattern. The single major item contributing to lack of more substantial positive growth is the lack of availability of water supply to meet these demands. The County offers an adequate road network to supply the potential growth needs of the area. The continued development of new employment will help spur the continued growth.

Presently four (4) school districts serve the Mills County area. These are: (1) Priddy Independent School District, (2) Mullin Independent School District, (3) Star Independent School District, and (4) Goldthwaite Independent School District. They offer sufficient capacity to handle increased growth and service needs.

As previously stated, the single item that is presently hindering future growth and economic development is lack of a dependable, quality, public water supply to meet the needs of the area. It is hoped that this report will help

address these concerns and allow the establishment of such a system.

3.3 Population Projection Studies

Federal census data was collected in 1980. From that date, historic and economic trends projections have been made by the Texas Water Development Board and the Texas State Data Center. Table 3.2 is a list of the population records. Figure 3-1 illustrates these trends.

TABLE 3.2

TWDB and Texas State Data Center Population Records

Year	TWDB Projection		Census Count	Texas State Data Center	
	High	Low		High	Low
1980	---	---	4,477	---	---
1985	---	---	4,527	---	---
1990	4,610	4,562	---	4,816	4,585
2000	4,966	4,856	---	5,406	4,692
2010	5,197	5,080	---	6,097	5,034
2020	5,364	5,225	---	6,642	5,545
2030	5,518	5,340	---	---	---
2040	5,595	5,397	---	---	---

TWDB Projections

<u>Year</u>	<u>Census or Average</u>	<u>Change</u>	<u>Annual % Growth</u>
1980	4,477	---	---
1985	4,527	+ 50	0.22%
1990	4,586	+ 59	0.26%
2000	4,911	+325	0.69%
2010	5,138	+227	0.45%
2020	5,295	+157	0.30%
2030	5,429	+134	0.30%
2040	5,496	+ 67	0.25%

Of the two studies and projections, the Texas Water Development Board projections are the most conservative and will serve as the basis for this report. These projections represent but a future prediction of growth at a given moment of time. As such, they should be updated annually to reflect the latest conditions and information. The impact these growth estimates have on future planning and improvements must also be updated.

4.0 EXISTING WATER SYSTEMS

In the course of this study the existing public water systems in Mills County were studied as well as the potential for development of additional surface and groundwater reserves in the County. These supplies and systems have previously been studied by other reports and the results of these efforts are summarized within this section. Additionally, the report looked at alternate public water supply sources that existed in the counties surrounding Mills County and their potential to provide the water needs of Mills County.

4.1 Water Source

In order to develop a dependable public water supply a source of good quality and dependable quantity of water must be available. Within Mills County the surface water and groundwater potentials will be evaluated.

- a. Surface Water Reserves: The Colorado River forms the western boundary of Mills County. The river is formed from a drainage area of approximately 25,000 square miles of western and central Texas. Upstream from Mills County numerous municipalities and private irrigators divert water from the Colorado River for

use. A major reservoir, called the Stacy Reservoir, is under construction and will have an impact on the flows of the Colorado River in Mills County. The combined effect of these developments and diversions along the river's course bear significantly on the consistency of flow in the river through Mills County. Included in Appendix C is the contract for operation of the Stacy Dam Reservoir by the Upper Colorado River Municipal Water District and the Lower Colorado River Authority to sustain downstream river flows.

Located at State Highway 190 and the Colorado River is a stream gauging station operated by the U.S. Geological Service and LCRA. At this point flow and water quality are measured on a regular basis. This station is approximately ten (10) miles south of Mills County. Historical data from these recordings indicate that the river does occasionally have a no-flow condition. Additionally, water quality records indicate that the total dissolved solids and/or salt content of the river is high and above those levels normally considered acceptable for potable treated water systems. Of note is the apparent correlation between the high flows and low solids and low flows and high solids. A summary of the 1988 results for the monitoring station is included as Appendix D to this

report. Tables 4.1, 4.2 and 4.3 are discussions of water quality standards and their significance.

Presently the City of Goldthwaite diverts its water supply from a diversion point located just downstream of the State Highway 16 crossing. This is approximately 22 miles upstream of the above gauging station. Another potential source of surface water for Mills County is the San Saba River. While not located within Mills County, it enters the Colorado River at the southwestern tip of Mills County, or approximately seven miles upstream of the gauging station. The river contains a drainage area of approximately 3,000 square miles. Water quality and flow data has been obtained from a federal and LCRA stream gauging station located at State Highway 16 and the San Saba River. The 1988 results for this station are included as Appendix E. The water quality appears to be generally good, with flow patterns similar to those seen on the Colorado River. There are periods during the recorded data when no-flow conditions have existed on the river. These attached graphs and charts indicate the comparison of flow and water quality between the Colorado and San Saba Rivers. The water quality parameter of total dissolved solids was used for this comparison. These dissolved solids include chlorides, sulfates and other

compounds generally found in water. The federal Safe Drinking Water Act Standards of 1986 provide a level of 500 parts per million (ppm) total dissolved solids as a maximum standard for treated public water drinking supplies. Quantities in excess of this level within the water system could cause taste and odor complaints.

Of concern on the San Saba River was the fact that springs from the Hickory Aquifer that feed the river may be causing radiation from the groundwater to contaminate the river. Samples collected by Haynie & Kallman, Inc. on September 22, 1989 and analyzed by the Texas Health Department, indicate levels well below maximum standard levels of 15 picocuries/liter. Samples were taken along the river at State Highway 16 (3.6 pc/l), Mill Creek (3.4 pc/l) and two miles downstream of Mill Creek (4.2 pc/l).

Mills County has numerous Soil Conservation Service flood control reservoirs located throughout the County. While these reservoirs hold a large total volume of water, no single site is large enough or sufficient for development into a source of public water supply.

**FIGURE 4-1
COLORADO RIVER**

**TOTAL DISSOLVED SOLIDS (TDS), RIVER FLOW (CFS)
vs
FIVE YEAR PERIOD 1984-88**

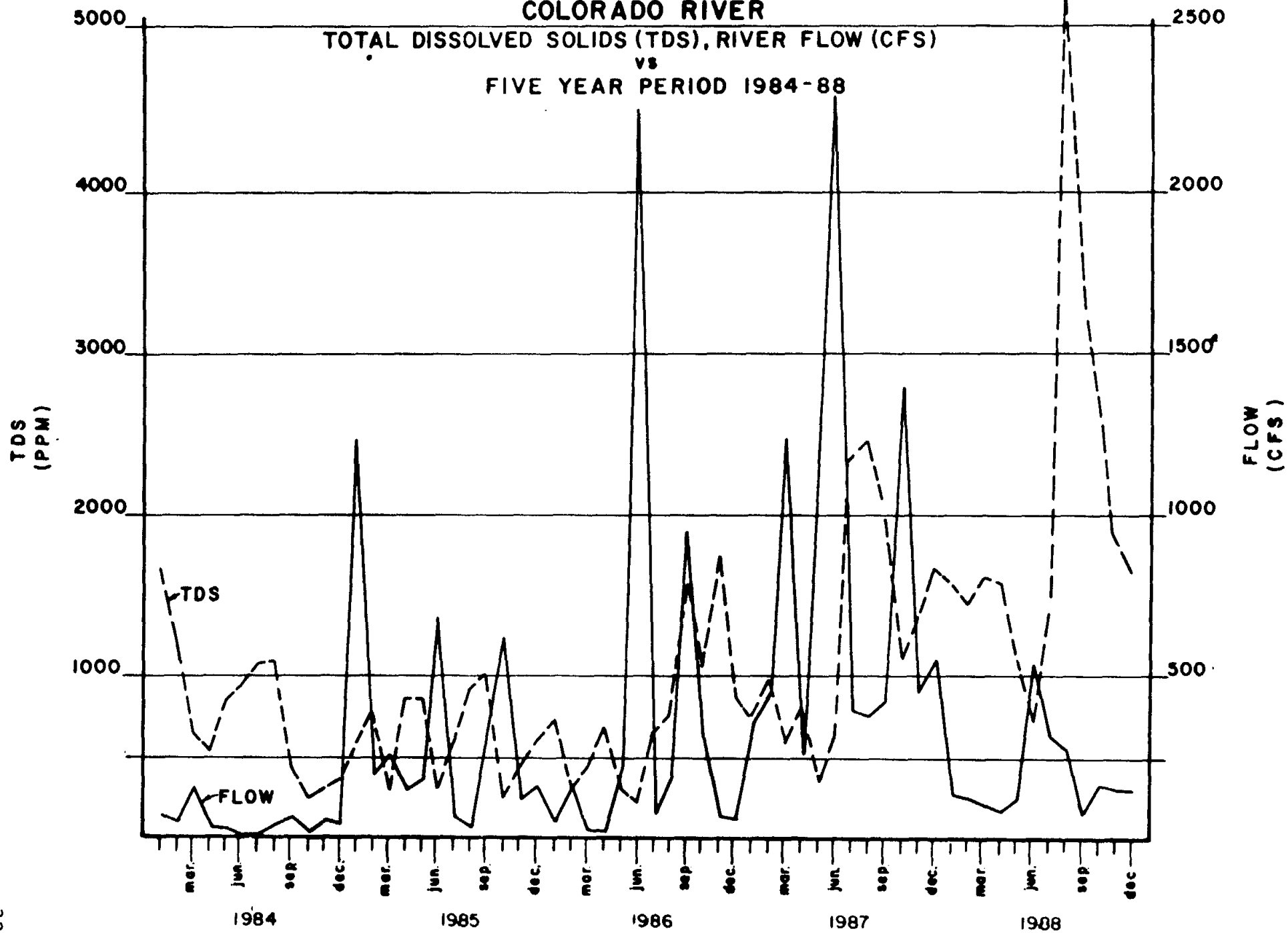

FIGURE 4-2
SAN SABA RIVER
TOTAL DISSOLVED SOLIDS (TDS), RIVER FLOW (CFS)
vs
FIVE YEAR PERIOD 1984-88

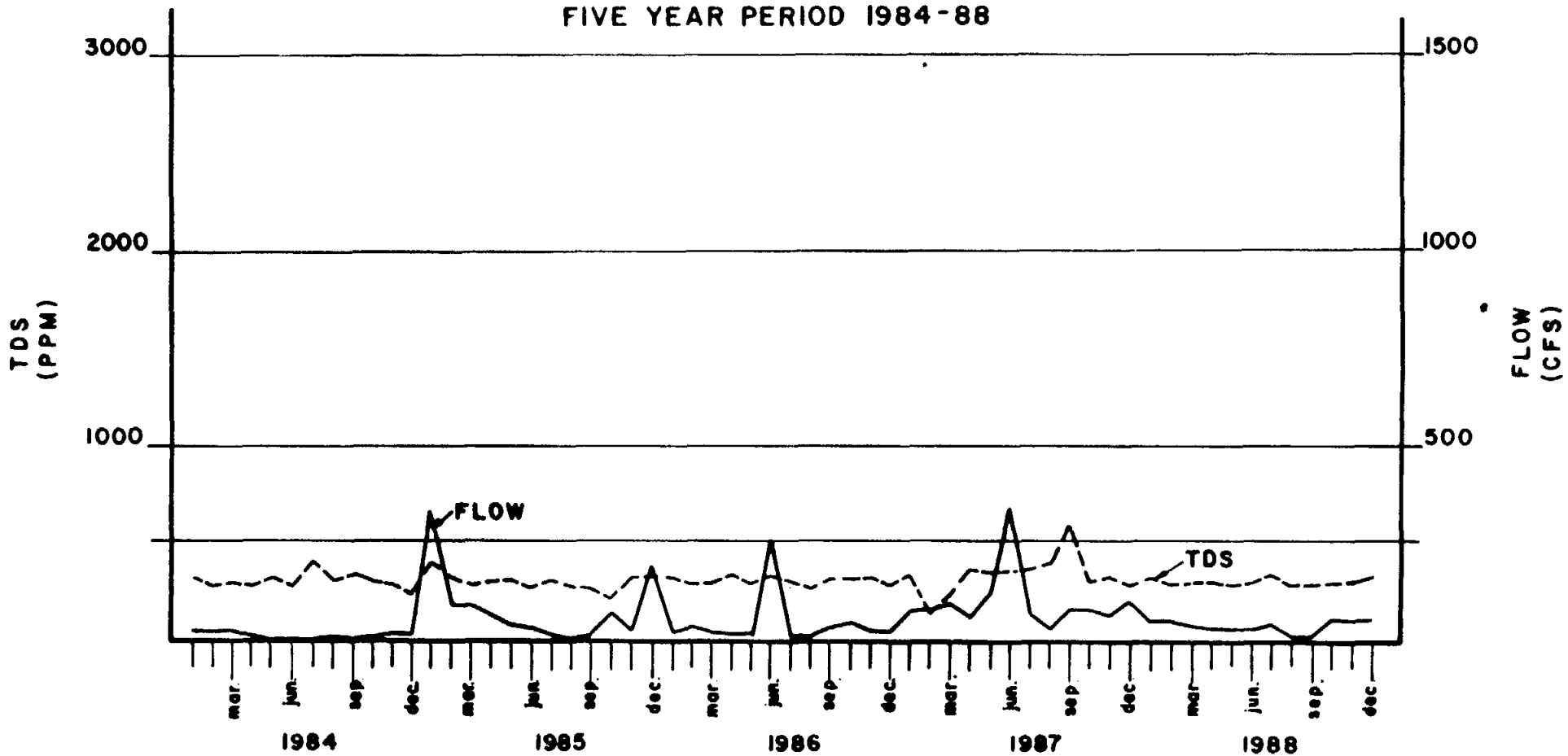

TABLE 4-1

DISCUSSION OF MINERAL LEVELS IN WATER AND THEIR EFFECT ON ITS USE

EXCERPT FROM TWDB 195

CONSTITUENT OR PROPERTY	SOURCE OR CAUSE	SIGNIFICANCE			
Silica (SiO ₂)	Dissolved from practically all rocks and soils, commonly less than 30 mg/l. High concentrations, as much as 100 mg/l, generally occur in highly alkaline water.	Forms hard scale in pipes and boilers. Carried over in steam of high pressure boilers to form deposits on blades of turbines. Inhibits deterioration of zeolite-type water softeners.	Chloride (Cl)	Dissolved from rocks and soils. Present in sewage and found in large amounts in oil-field brines, sea water, and industrial brines.	In large amounts in combination with sodium, gives salty taste to drinking water. In large quantities, increases the corrosiveness of water. U.S. Public Health Service (1962) drinking water standards recommend that the chloride content should not exceed 250 mg/l.
Iron (Fe)	Dissolved from practically all rocks and soils. May also be derived from iron pipes, pumps, and other equipment.	On exposure to air, iron in ground water oxidizes to reddish-brown precipitate. More than about 0.3 mg/l stain laundry and utensils reddish-brown. Objectionable for food processing, textile processing, beverages, ice manufacture, brewing, and other processes. U.S. Public Health Service (1962) drinking water standards state that iron should not exceed 0.3 mg/l. Larger quantities cause unpleasant taste and favor growth of iron bacteria.	Fluoride (F)	Dissolved in small to minute quantities from most rocks and soils. Added to many waters by fluoridation of municipal supplies.	Fluoride in drinking water reduces the incidence of tooth decay when the water is consumed during the period of enamel calcification. However, it may cause mottling of the teeth, depending on the concentration of fluoride, the age of the child, amount of drinking water consumed, and susceptibility of the individual (Maier, 1960, p. 1120-1132.)
Calcium (Ca) and Magnesium (Mg)	Dissolved from practically all soils and rocks, but especially from limestone, dolomite, and gypsum. Calcium and magnesium are found in large quantities in some brines. Magnesium is present in large quantities in sea water.	Cause most of the hardness and scale-forming properties of water; soap consuming (see hardness). Waters low in calcium and magnesium desired in electroplating, tanning, dyeing, and in textile manufacturing.	Nitrate (NO ₃)	Decaying organic matter, sewage, fertilizers, and nitrates in soil.	Concentration much greater than the local average may suggest pollution. U.S. Public Health Service (1962) drinking water standards suggest a limit of 45 mg/l. Waters of high nitrate content have been reported to be the cause of methemoglobinemia (an often fatal disease in infants) and therefore should not be used in infant feeding (Maxcy, 1960, p. 271). Nitrate shown to be helpful in reducing inter-crystalline cracking of boiler steel. It encourages growth of algae and other organisms which produce undesirable tastes and odors.
Sodium (Na) and Potassium (K)	Dissolved from practically all rocks and soils. Found also in oil-field brines, sea water, industrial brines, and sewage.	Large amounts, in combination with chloride, give a salty taste. Moderate quantities have little effect on the usefulness of water for most purposes. Sodium salts may cause foaming in steam boilers and a high sodium content may limit the use of water for irrigation.	Boron (B)	A minor constituent of rocks and of natural waters.	An excessive boron content will make water unsuitable for irrigation. Wilcox (1955, p. 11) indicated that a boron concentration of as much as 1.0 mg/l is permissible for irrigating sensitive crops, as much as 2.0 mg/l for semitolerant crops, and as much as 3.0 mg/l for tolerant crops. Crops sensitive to boron include most deciduous fruit and nut trees and navy beans, semitolerant crops include most small grains, potatoes and some other vegetables, and cotton; and tolerant crops include alfalfa, most root vegetables, and the date palm.
Bicarbonate (HCO ₃) and Carbonate (CO ₃)	Action of carbon dioxide in water on carbonate rocks such as limestone and dolomite.	Bicarbonates and carbonate produce alkalinity. Bicarbonates of calcium and magnesium decompose in steam boilers and hot water facilities to form scale and release corrosive carbon-dioxide gas. In combination with calcium and magnesium, cause carbonate hardness.	Dissolved solids	Chiefly mineral constituents dissolved from rocks and soils.	U.S. Public Health Service (1962) drinking water standards recommend that waters containing more than 500 mg/l dissolved solids not be used if other less mineralized supplies are available. For many purposes the dissolved-solids content is a major limitation on the use of water. A general classification of water based on dissolved-solids content, in mg/l, is as follows (Winslow and Kiser, 1956, p. 5): Waters containing less than 1,000 mg/l of dissolved solids are considered fresh; 1,000 to 3,000 mg/l, slightly saline; 3,000 to 10,000 mg/l, moderately saline; 10,000 to 35,000 mg/l, very saline; and more than 35,000 mg/l, brine.
Sulfate (SO ₄)	Dissolved from rocks and soils containing gypsum, iron sulfides, and other sulfur compounds. Commonly present in some industrial wastes.	Sulfate in water containing calcium forms hard scale in steam boilers. In large amounts, sulfate in combination with other ions gives bitter taste to water. U.S. Public Health Service (1962) drinking water standards recommend that the sulfate content should not exceed 250 mg/l.			

TABLE 4-2

TOTAL DISSOLVED SOLIDS

EXCERPT FROM TWDB REPORT 195

The total dissolved-solids content is a major limiting factor in the use of water. The following general classification of water is based on dissolved solids (Winslow and Kister, 1956, p. 5).

<u>DESCRIPTION</u>	<u>DISSOLVED-SOLIDS CONTENT (MG/L)</u>
Fresh	Less than 1,000
Slightly saline	1,000 to 3,000
Moderately saline	3,000 to 10,000
Very Saline	10,000 to 35,000
Brine	More than 35,000

Quality limits for livestock are variable. The limits of tolerance depend principally on the kind of animal and, according to Heller (1933, p. 22), the total amount of soluble salts in the drinking water, more so than the kind of salt, is the important factor. According to Hem (1959, p. 241), a high proportion of sodium or magnesium and sulfate in highly mineralized waters would make them very undesirable for livestock use. Heller also suggests that as a safety rule 15,000 mg/l dissolved-solids content should be considered the upper limit for most of the more common livestock animals. According to Hem (1959, p. 241), the California State Water Pollution Control Board (1952) quotes other investigators who have found concentrations as high as 15,000 mg/l to be safe for limited periods but not for continuous use. In a publication (1950) relating to practices in Western Australia, the officers of the Department of Agriculture of that state quote the following upper limits for dissolved-solids concentration in livestock water (Hem, 1959, p. 241).

<u>ANIMAL</u>	<u>DISSOLVED SOLIDS (MG/L)</u>
Poultry	2,860
Pigs	4,290
Horses	6,435
Cattle (dairy)	7,150
Cattle (beef)	10,000
Adult sheep	12,900

In evaluating surface water alternatives for Mills County, a consideration in determining alternate sources is the fact that the boundary between the Brazos River and Colorado River watersheds runs through the County. The eastern half of the County is in the Brazos River watershed with the western half being in the Colorado River watershed. The sources of water described herein lie within the Colorado River watershed and it may be necessary to seek approval from the Texas Water Commission to allow transfer of waters from the Colorado River or western half into the eastern half or Brazos River watersheds. Since the initial efforts of the study will be to provide water for the western half or Colorado River watershed, this is not an immediate concern but will need to be addressed as ultimate plans for County-wide water system development occur.

- b. Groundwater: The other source of public and private water supplies within Mills County are groundwater reserves located throughout the County. Major sources of information on the area's groundwater reserves is contained in the TWDB Report 195 - "Groundwater Resources of Part of Central Texas with Emphasis on the Antler and Travis Peak Formation," and TWDB Report No. 51 - "Reconnaissance Investigation of the Ground-Water Resources of the Colorado River Basin." The major



FIGURE 4-3
WATER SHED BOUNDARY
MILLS COUNTY

underground formation that supplies this water is the Travis Peak Formation. The location and abundance of groundwater is spotty throughout the County. Approximately the western half of the County, that being west of Highway 183, has limited sources of groundwater available for use as a public drinking water supply. To the east of Highway 183, the eastern half of the County, the groundwater reserves are somewhat better but still without consistent and adequate supplies for development. The numerous private wells within the County are subject to groundwater fluctuations based on climatic conditions as well as pumpage from surrounding wells. Therefore, the development of a county-wide water system based on groundwater reserves does not appear to be sufficient for development. Groundwater research should continue with the realization that many private systems, especially east of Highway 183, will continue to depend on groundwater. The District should continue to explore the possibilities for groundwater and also work toward the development of wellhead protection measures to ensure protection of the available groundwater reserves of the County.

Public Water Systems in Mills County

There are two (2) major public water supply systems that presently operate in Mills County -- those being the City of Goldthwaite and the City of Priddy, with a third group being a combination of many small restaurants and school districts that operate systems for their particular installations.

- a. City of Goldthwaite: The City operates by far the largest public water system in the County. Presently the City serves approximately 900 customers within the City itself. The City's system originally consisted of two (2) wells that provided water. Due to low reliability and fluctuations in elevations and water quality, in 1963 the City participated in the creation of the Mills County Fresh Water Supply District No. 1. This district sold bonds to construct a surface water supply system for the City. This supply consists of a pump station on the Colorado River and a series of off-line holding reservoirs where water can be stored during periods of low flow or poor quality on the Colorado River. The attached schematic shows a generalization of the existing facilities. Water from the reservoirs is treated at the City's water treatment plant which is rated at 600 gallons per minute (gpm) or

FIGURE 4-4

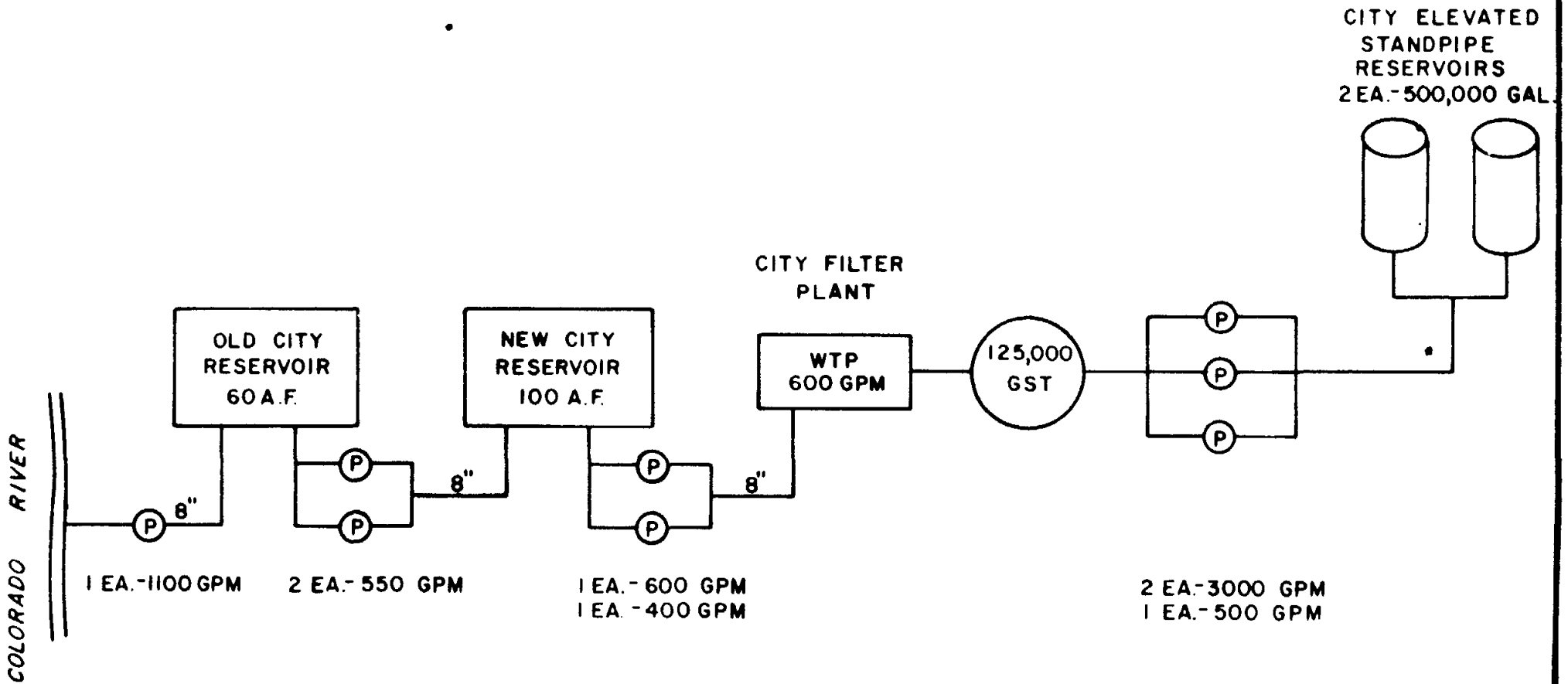

EXISTING CITY OF GOLDTHWAITE WATER SYSTEM

can serve approximately 1,000 connections. From the treatment plant water is pumped to the two (2) 500,000 gallon standpipe reservoirs located on the eastern edge of the City. These reservoirs supply pressure and water storage for the City.

The City has a contract from the State of Texas for the diversion of water from the Colorado River. This authorization is attached. The City, in an adjudication suit filed as a water user on the Colorado River, is authorized to withdraw 800 acre/feet per year for municipal use and an additional 700 acre/feet per year for industrial. Since the industrial users can be and are presently supplied through the public water system, this allows diversion and off-line storage of up to 1,500 acre/feet per year of water for the City. Based on present projections of population and water usage for the County, the raw water diversion contract should be sufficient to serve the County well past the year 2040.

The two (2) off-line holding reservoirs have a volume of approximately 200 acre/feet. This equates to approximately 20 surface acres of area with an average depth of 10-feet. In recent years the City has had to rely on this storage volume to store water during

FIGURE 4-5

T.W.C. ADJUDICATION OF THE COLORADO RIVER BASIN MIDDLE SEGMENT - 1981

DIVERSION POINTS NOS. 1520 and 1530
TRACT NO: 1040

OWNERSHIP: City of Goldthwaite

IR: 163
APP: 21
IV SF 606-628; X SF 14-32

SECTION 11.307 CLAIM: Under Permit No. 1971 to divert from the Colorado River 900 acre-feet of water per year for municipal use and 700 acre-feet of water per year for industrial use at a maximum diversion rate of 10 cfs (1400 gpm) with a priority date of May 6, 1960. A 115 acre-foot capacity, off-channel reservoir is also claimed. (Exh. 418)

FINDINGS:

1. Claimant is the owner of Permit No. 1971 which originally authorized the diversion and use of 900 acre-feet of water per year for municipal purposes and 700 per year for industrial purposes from the Colorado River into a 500 acre-foot capacity off-channel reservoir at a maximum diversion rate of 10 cfs in Survey No. 60, Abstract No. 676, Mills County. (Exh. 420)
2. A special condition in the permit is as follows:

The permittee shall install a metering instrument which will automatically record within five per cent (5%) of accuracy the total amount of water diverted from the Colorado River. The metering instrument and the design, installation and operation thereof shall be subject to approval by the Department.
3. Application No. 2167 for the permit was accepted for filing by the Commission on May 6, 1960 and Permit No. 1971 was issued on November 1, 1960. (Exh. 422)
4. Extensions of time to commence construction of work described in the permit were granted by the Commission on April 10, 1961, June 18, 1961 and May 1, 1961. (Exhs. 421, 422, 423)
5. By order dated December 9, 1963, the Commission approved a change in location of the reservoir, a reduction in the authorized capacity to 115 acre-feet, and a reduction in the authorized diversion rate to 1400 gpm. (Exh. 424)
6. Claimant maintains two authorized off-channel reservoirs with a total impounding capacity of 115 acre-feet at authorized diversion point D-1530 in T-1040 in Survey No. 60, Mills County. The area in which the reservoirs are located is designated as T-1040. (IV SF 610-612)
7. Since the permit was issued, State water has been diverted at D-1520 on the Colorado River, an unauthorized diversion point 1800 feet downstream from the authorized point, by means of a stationary pump at a maximum effective diversion rate of 3.12 cfs (1400 gpm). Water is diverted into the reservoirs at D-1530, then pumped to the city of Goldthwaite where it is treated and put into the municipal system. (IV SF 612, 617)
8. All water used for industrial purposes is treated water from the city's municipal system. (IV SF 617)
9. There are no intervening diverters between D-1520 and the authorized diversion point. (Exh. 7)
10. The maximum amount of State water diverted and used in any calendar year since the permit was issued was 630 acre-feet of water for municipal purposes in 1975 and 12 acre-feet for industrial purposes in 1974. (X SF 19, 24, 28)
11. There was evidence presented of (1) justification for the lack of development to the full extent of the authorization under the permit and (2) an intention to increase the use of State water under the permit in the foreseeable future. (IV SF 621, 623)
12. There was no evidence presented concerning compliance with the special condition.

CONCLUSIONS:

1. The use of water by claimant for industrial purposes is actually a municipal use as defined by Rule 156.01.20.115.
2. Claimant is recognized a right under Permit No. 1971 to divert and use not to exceed 646 acre-feet of water per year for municipal purposes from diversion point D-1520 on the Colorado River at a maximum diversion rate of 3.12 cfs (1400 gpm) with a priority date of May 6, 1960.
3. Claimant may diligently develop the appropriation to divert and use not to exceed 900 acre-feet of water per year for municipal purposes and 700 acre-feet of water per year for industrial purposes from D-1520 at a maximum diversion rate of 3.12 cfs (1400 gpm) with a priority date of May 6, 1960.
4. The water authorized to be diverted is to be stored in two off-channel reservoirs at diversion point D-1530 in Survey No. 60 (A-696), Mills County, with a total impounding capacity of 115 acre-feet for subsequent diversion and use to the extent authorized herein.
5. The claimant shall install a metering instrument which will automatically record within five per cent (5%) of accuracy the total amount of water diverted from the Colorado River. The metering instrument and the design, installation and operation thereof shall be subject to approval by the Department.

periods of low water flow and poor quality conditions on the Colorado. It is estimated that the existing reservoirs contain approximately 6-months of storage capacity for the existing system. Storage volume is calculated as follows: 200 A-F x 43,560 SF/acre x 7.48 G/CF x 1/350 GPCD x 1/1000 Exist. Conn. = 186 days. The reservoirs' influent pump stations are connected to the water treatment plant via an 8-inch water line constructed along Highway 16. At the water treatment plant the water is settled, filtered, and disinfected prior to storage on-site in the plant's ground storage tank. The water is then pumped from the plant to the standpipe reservoirs located on the opposite side of town.

b. City of Priddy: The Priddy Water Supply Corporation operates a public water system for the residents of Priddy. The system consists of two (2) wells that pump to a ground storage pressure tank system for use by the area residents. The Priddy system presently serves about 85 connections or 250 people. Recently, in 1989 the City was given federal grant money to improve the water system by the addition of a new well and addition of system improvements.

c. Private Systems: In addition to these systems, there are numerous small private systems operating throughout

the County. These are primarily restaurant systems that provide water to their customers. They are small in nature. In addition, the three (3) school districts of Mullin, Priddy and Star each have an individual water system for their school locations. To date, it has not been economical to combine each of these systems, nor does each individual system have capacity to supply water to the other's existing needs. Therefore, they have developed independently and operate as such. The attached chart is a summary of the systems as obtained from the Texas Department of Health.

4.3 Public Water Systems Outside Mills County

To the north of Mills County is located Brown County. Within Brown County is a large surface water reservoir known as Lake Brownwood, constructed and owned by the Brown County Water Control and Improvement District No. 1. The water from Lake Brownwood furnishes municipal water for the Brown County cities of Brownwood, Early, Bangs, Zephyr, Brookesmith and most of the western rural areas of Brown County. The reservoir is located on Pecan Bayou approximately eight (8) miles north of the City of Brownwood. It has a surface area of approximately 7,300 acres and a volume of approximately 143,400 acre/feet.

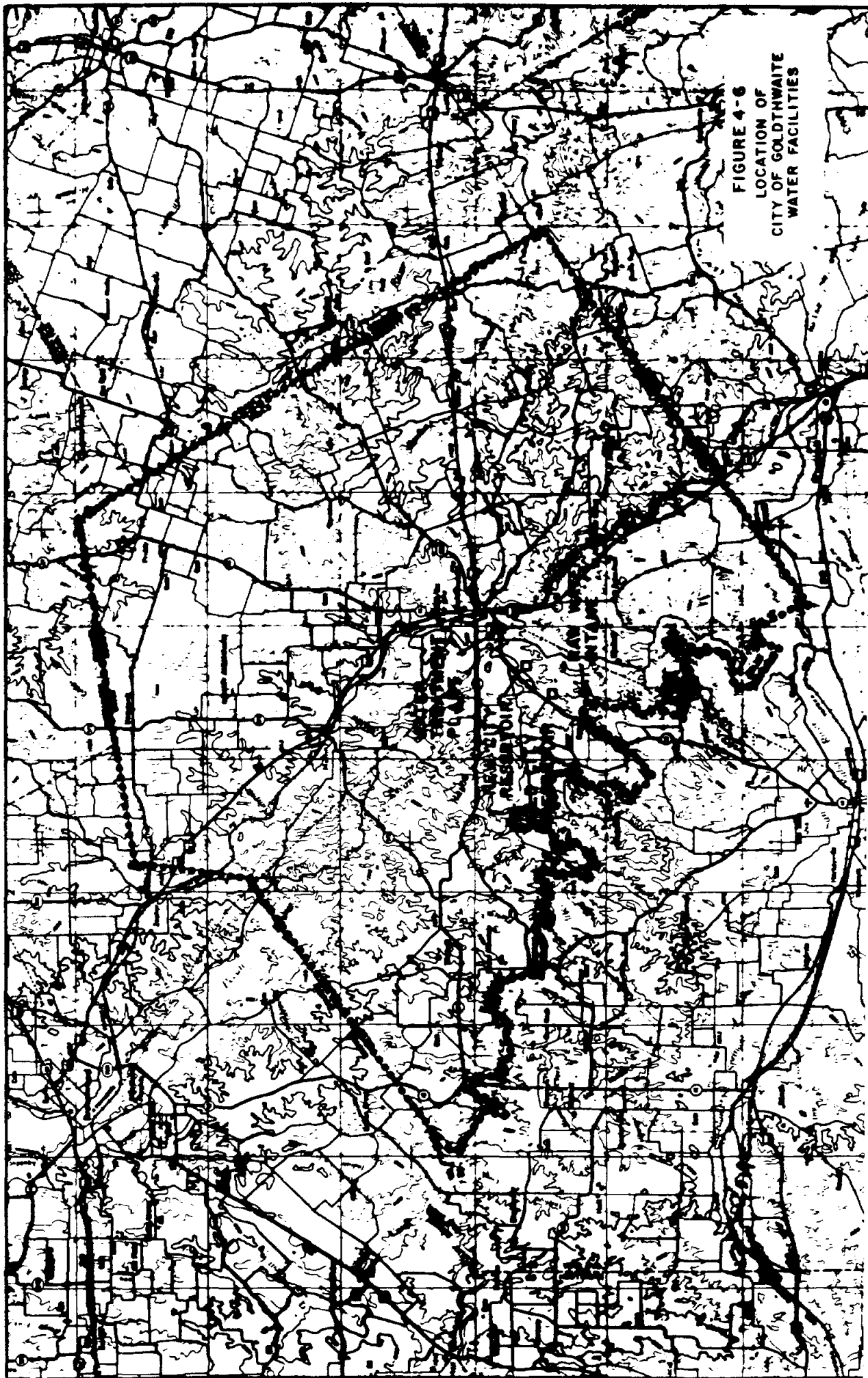

FIGURE 4-6
LOCATION OF
CITY OF GOLDTHWAITE
WATER FACILITIES

TABLE 4.4

Existing Water Systems Within Mills County, Texas

<u>System ID No.</u>	<u>System Name</u>	<u>People Served</u>	<u>No. Conn.</u>	<u>Total Prod. (MGD)</u>	<u>Total Storage (MG)</u>	<u>Elev. Storage (MG)</u>	<u>Source Name</u>	<u>No. Wells</u>	<u>Survey Date</u>
<u>GOLDTHWAITE</u>									
1670001	City of Goldthwaite	1,800	909	0.829	1.148	1.0 (1)	Edw-Trinity	3	86/06
1670017	Brinegan Quick Stop	25	1	0.040	0.040	0	Trinity	1	86/06
1670018	Carr's Cafe & Texaco	50	2	0.000	0.000	0	Trinity	1	86/06
1670005	Hereford Motel	25	20	0.033	0.005	0	Trinity	2	86/06
1670014	Hill Country Store	200	1	0.030	0.000	0	Trinity	1	86/06
1670014	New Horizons Ranch	91	14	0.020	0.069	0 (2)	New Horizon Lk	0	86/06
1670010	Dairy Queen	500	2	0.007	0.000	0	Trinity	1	86/06
<u>MULLIN</u>									
1670013	Mullin ISD	150	1	0.000	0.000	0	Trinity	1	84/12
<u>PRIDDY</u>									
1670002	Priddy Water System	250	85	0.086	0.034	0 (3)	Trinity	4	86/06
<u>STAR</u>									
1670016	Star ISD	75	1	0.029	0.001	0	Trinity	1	84/12

NOTES:

- (1) City of Goldthwaite has a booster pump capacity of 1.426 MGD.
The City of Goldthwaite also treats water taken from the Colorado River to supplement its well water supply.
- (2) New Horizons Ranch has a booster pump capacity of 0.360 MGD.
- (3) Priddy has a booster pump capacity of 0.065 MGD.

All facilities are listed as active.

Source: Texas Department of Health - Inventory of Texas Water Supply Systems.

Preliminary discussions with the district's manager, Mr. Harry Miller, indicated a reluctance to serve water outside of the Brown County limits. This is in part due to the district's charter and creation to provide water within Brown County. Additionally, by looking at the existing transmission systems and distances from where water lines would need to be oversized and water obtained from, the route is quite long and would be very expensive.

North and east of Mills County are Comanche and Hamilton Counties. These counties have natural available groundwater reserves from the Travis Peak Formation. Additionally, Lake Proctor in Comanche County provides a source of surface water for irrigation needs of the county. Because of the need for water service to the western half of Mills County, water sources from these areas were ruled out because of the distance involved in production and transportation of the water to the western half of Mills County. Additionally, these areas are within the watershed of the Brazos River Authority whereas the western half of Mills County is in the watershed of the Lower Colorado River Authority. Interbasin transfers of water are not usually allowed without special considerations from the river authorities and the Texas Water Commission.

South of Mills County is Lampasas County which obtains water from groundwater as well as surface water supplies. The closest major public water supplier in the county is the Lometa Water Supply Corporation which serves the town of Lometa and the rural area just south of Mills County. The rural district obtains water from Lake Stillhouse Hollow and the Brazos River Authority. It is treated and distributed through their rural system. The Water Supply Corporation was funded by grants from the federal Farmer's Home Administration. In order to transfer water into Mills County their entire system would need to be upgraded to transmit water through their system to serve a portion of Mills County.

Located to the west of San Saba County and to the west of Mills County, counties of San Saba and Lampasas the underground formation that provides most of the water is the Hickory Sands Underground Formation. This area extends into McCulloch, Concho, Menard, Mason, Kimble and Gillespie Counties. The aquifer has been developed with deep wells into the lower Cambrian geologic structure. The northeastern limit of the aquifer appears to be a fault which roughly follows the trace of the Colorado River through the area adjacent to Mills County. The fault was created as a result of a Llano uplift in this area. The top of the sands in eastern San Saba County

occur at a depth of 3,000 to 3,500 feet and are approximately 4,000 feet thick. The formation outcrops in southern San Saba County and western Llano County. Typical formations include the Mill Creek Pond Reservoir located in nearby San Saba and the source of the City of San Saba's drinking water. The closest public water supplies to Mills County are those of the North San Saba Water District located just west of San Saba County. The water quality is generally of good chemical quality with the exception of total alpha radiation. The radiation is naturally occurring in the underground formation and produces levels above those allowed by the 1986 Safe Water Drinking Act. The attached table is a typical water quality record for wells in the area. The Texas Department of Health has required the public water systems using this formation to begin quarterly notification of their customers of the water's failure to meet the total requirements. The potential for development of the Hickory Formation as a source of water for Fox Crossing Water District will be further discussed in a later section.

Therefore, based on the water alternatives presented, it would appear that the three most likely options that would merit additional discussion and consideration for development of an initial public water system for the

TABLE 4.5

PAGE 1

**COPY - CENTRAL OFFICE
REG-01 SAN SABA

WATER ANALYSIS REPORT
TEXAS DEPARTMENT OF HEALTH
DIVISION OF WATER HYGIENE
1100 WEST 49 TH STREET
AUSTIN, TEXAS 78756

NORTH SAN SABA WTR SUPPLY CORP
C/O DAVE DAVENPORT - PRESIDENT
ROUTE 2 BOX 64 A
SAN SABA TX 76877

WATER SUPPLY #: 2060003
LABORATORY NO: EP807145
SAMPLE TYPE: DISTRIBUTION

COLLECTOR REMARKS:

SOURCE: WELL 1

DATE COLLECTED 8/18/88 DATE RECEIVED 8/22/88 DATE REPORTED 10/26/88

CONSTITUENT NAME	RESULT	UNITS	+/-
Calcium	5	mg/l	
Chloride	288	mg/l	
Fluoride	1.6	mg/l	
Magnesium	1	mg/l	
Nitrate (as N)	0.04	mg/l	
Sodium	354	mg/l	
Sulfate	25	mg/l	
Total Hardness/CaCO3	17	mg/l	
pH	8.5		
Dil. Conduct (umhos/cm)	1796		
Tot. Alka. as CaCO3	364	mg/l	
Bicarbonate	427	mg/l	
Carbonate	8	mg/l	
Dissolved solids	901	mg/l	
P. Alkalinity /CaCO3	7	mg/l	
Arsenic	< 0.010	mg/l	
Barium	< 0.50	mg/l	
Cadmium	< 0.005	mg/l	
Chromium	< 0.02	mg/l	
Copper	< 0.02	mg/l	
Iron	0.02	mg/l	
Lead	< 0.02	mg/l	
Manganese	< 0.02	mg/l	
Mercury	< 0.0002	mg/l	
Selenium	< 0.002	mg/l	
Silver	< 0.01	mg/l	
Zinc	< 0.02	mg/l	
Gross Alpha	28.00	pCi/l	6.0
Total Radium	10.00	pCi/l	1.0
Radium 226	8.10	pCi/l	0.3
Radium 228	13.00	pCi/l	2.0
Total Uranium	< 3.00	pCi/l	
Gross Beta	18.00	pCi/l	5.0

western half of Mills County would be the further development of the City of Goldthwaite's diversion from the Colorado River.

Secondly, in addition to the above consideration would be a tie-in and separate feed from the San Saba River supplementing the water supply from the City of Goldthwaite. Thirdly, would be the development of a groundwater well in San Saba County and transporting that water for usage into Mills County. The costs and relative advantages and disadvantages of each of these will be developed in Section 6 of this report.

5.0 PROJECTED WATER DEMAND

An important consideration in the planning for future water needs for the FCWD is the projection of the quantity of water that will be required for any given year during the planning period. Currently because the District does not operate any water facilities, records for production and sale of water in the study area are limited. For this reason, it was necessary to rely on other sources to develop historic and projected water usage.

5.1 Water Use Projections

The Texas Water Development Board has prepared data for the study area that projects both normal water use as well as the potential savings with conservation measures in effect. These records are prepared from the available municipal records and various sources of general water use trends in the State, and compiled by the Water Development Board for planning purposes for State water needs. A copy is included as Appendix F. A review of these records indicates that these projections seem reasonable and within normal consumption demands for other area systems. The attached graphs provide a summary of the projected water demands through the year 2040. These demands are shown in acre/feet with a high and a low range. These

FIGURE 5-1

PROJECTED MILLS COUNTY WATER USE

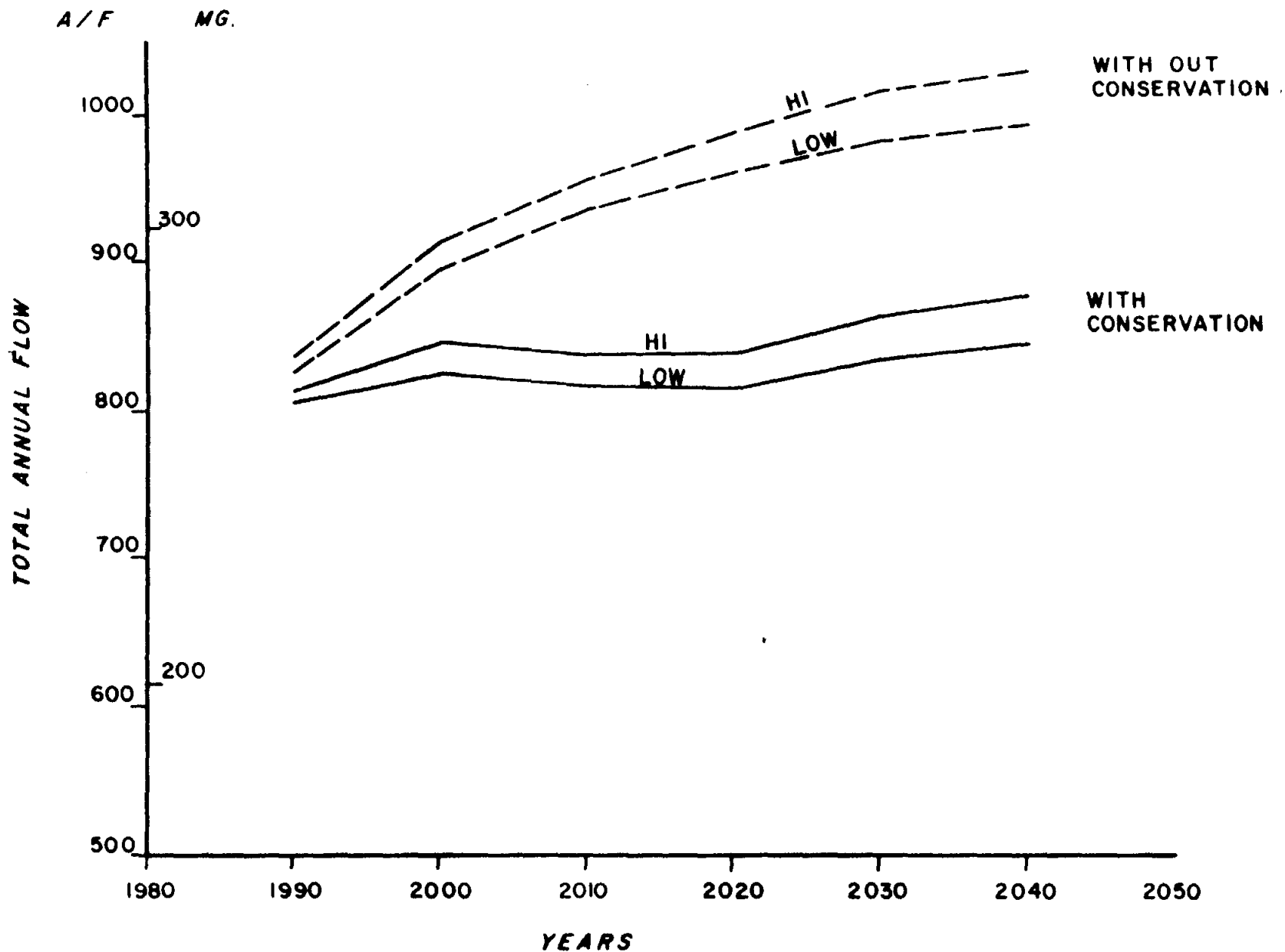
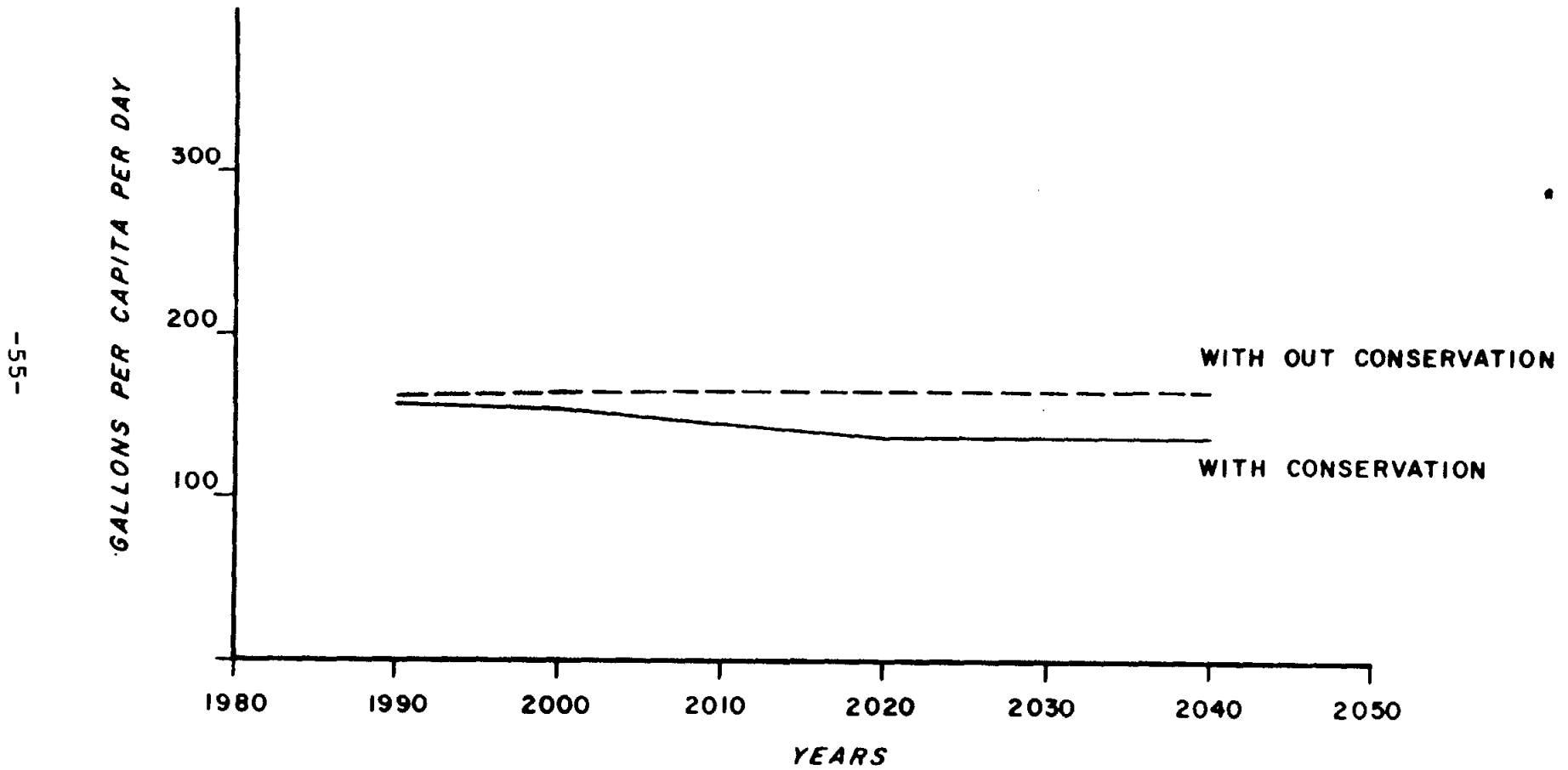

FIGURE 5-2

PROJECTED COUNTY WIDE WATER USE -
AVERAGE PER CAPITA



numbers are also converted into millions of gallons per year, and into gallons per capita per day consumption based on the proposed population projections. As can be seen, the effects of a conservation program as described in the Appendix of this report, can provide substantial water savings for the area. Also included in Appendix F are projections also prepared by the Water Development Board for other uses within the County other than the municipal public water supply demands that were described above. These other system demands for use of water in the area could include irrigation, livestock water, manufacturing, etc., as well as other sources.

5.2 Design Criteria

In order to properly design the rural public water system for the FCWD design criteria and guidelines must be established for use in laying out the parameters for proper system design. Because of the lack of historic water records and water demands in the area, the Texas Department of Health, "Rules and Regulations for Public Water Systems," will be used as a guideline. These regulations establish minimum public water quality requirements for community-type public water systems. These minimum water quality requirements were established for facilities to insure their ability to maintain a

minimal residual water pressure of 20 psi at a minimal normal operating pressure of 35 psi. Water storage is required by the Health Department at the rate of 200 gallons per connection of ground storage capacity and elevated storage capacity of at least 100 gallons per connection in lieu of other pressure maintenance facilities. Elevated storage in the amount of 200 gallons per connection may be substituted for ground storage and pressure tank installations. Booster pump station capacities must have two (2) or more pumping units with a total rated capacity of 2 gpm per connection and be sufficient to meet peak demands. Surface water treatment systems must be sized for a peak day treatment requirement of 0.6 gallons per minute per connection served. Well or groundwater production systems must also be sized for production rates of 0.6 gallons per minute per connection and also sufficiently sized to meet peak demands.

6.0 PROPOSED IMPROVEMENTS

6.1 Planning Guidelines

Fox Crossing Water District does not presently own or operate any water supply system improvements. Therefore, in formulating a plan to construct the necessary facilities to serve the District's service area several considerations and guidelines were established by the Fox Crossing Water District Board of Directors for the Engineer to use in evaluating service alternatives.

The Board directed that the proposed improvements are to be funded by a user-generated revenue system. This would either be on payment for water service via tap fees or on a rate basis for actual service received or a combination of the two methods. The District did not want to generate and collect an area-wide tax because of the difficulty in equitably assessing and collecting this type of revenue mechanism.

Secondly, the initial area of effort in order to provide service should be directed toward the western half of Mills County. This area, approximately between State Highway 183 on the east and the Colorado River on the west, is the area that presently has the most limited

groundwater reserves. After the development of water service to this area then the remaining areas of the County would be developed.

Finally, further impacting the initial service plans are the sparse rural populations of Mills County. Proposed water improvements must traverse many miles between customers. These limitations will weigh heavily on the cost per connection of providing service within the area. These planning restrictions will weigh heavily on the type, location and affordability of service decisions that will have to be made by the Fox Crossing Water District Board of Directors.

6.2 Service Alternatives

As previously discussed in investigating a source of water to develop the Fox Crossing water system, three alternatives would seem appropriate for further consideration at this time. These would be (1) the additional development of the existing City of Goldthwaite water system, (2) in addition to item 1 would be to supplement the existing raw water supply for the City by developing a second source of water from the San Saba River in San Saba County, and (3) the development of a groundwater supply system from the Hickory Underground

Aquifer also in San Saba County. This report will attempt to develop a scenario for the utilization of these sources, their relative cost, and a discussion of their relative advantages and disadvantages for consideration in selection of an acceptable source.

6.2.1 City of Goldthwaite

The first alternative is to tie into the existing City of Goldthwaite system that produces water from the Colorado River, is stored in off-line holding ponds, treated and pumped into the City's distribution system. This system could be easily expanded with the existing facilities utilized for initial service to hold down initial development costs.

For a system expansion to serve approximately 500 connections, the initial improvements would be to increase the existing water treatment plant from 600 gallons per minute (gpm) to 900 gpm. This would involve parallel expansion of the treatment plant's clarifiers, filters, ground storage tank and pump station facilities. The City has adequate land available at the treatment plant site for this expansion. In this expansion, the off-line storage capacity of the City's existing facilities would need to be increased at the City's new reservoir site.

COLORADO RIVER

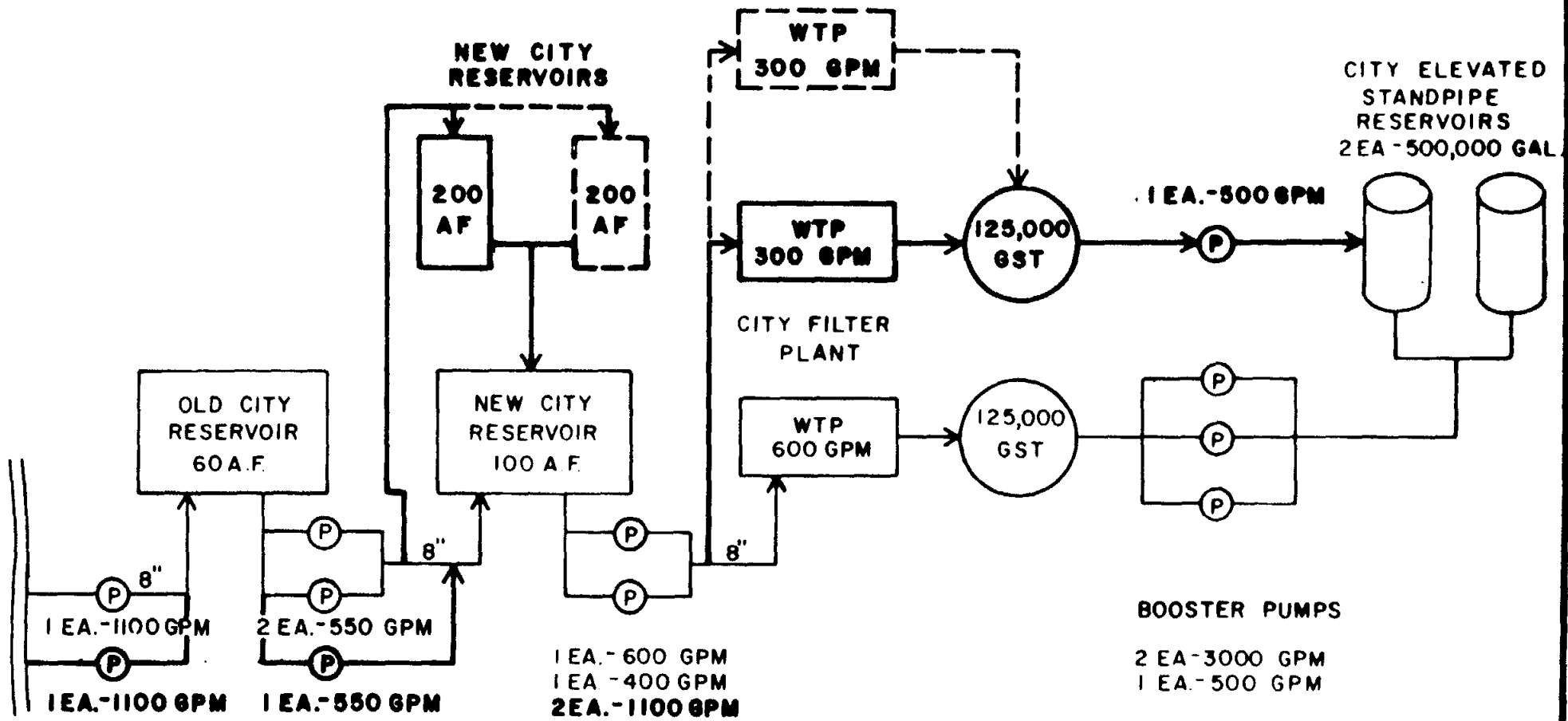

LEGEND

- EXISTING
- PROPOSED
- - - FUTURE

FIGURE 6-1

PROPOSED IMPROVEMENTS TO THE CITY OF GOLDTHWAITE WATER SYSTEM

Additional land is presently available for a system expansion of an additional 400 acre/feet of storage. This initial expansion would only require a 200 acre/foot expansion to maintain the City's existing off-line capacity of approximately six-months storage for their customers. Additions and modifications to the pump stations at each of the reservoir sites as well as the raw water intake could be phased into later expansions and would not be necessary for construction with the initial funding. The 8-inch water line that connects the reservoir sites and the water treatment plant also has enough capacity to meet the initial service needs without additional expansion. The attached schematic shows a representation of the proposed improvements and future improvements that could be utilized for construction with this scenario.

The advantages of this option are (1) its low first year and latter year costs of construction, (2) low operating cost, (3) shortest time to permit and construct, (4) the City's abundant raw water diversion contract with the State of Texas, (5) the existing land area and easements necessary to construct the proposed expansion, and (6) the redundant nature of the equipment that is already in place for process reliability.

The disadvantages of this alternative would be (1) the seasonal fluctuations in water quality and quantity that occur along the Colorado River, (2) the levels of total dissolved solids in excess of State and Federal requirements that seasonally occur on the Colorado River, (3) the District would be required to mutually develop, administer and manage the proposed facilities with the City of Goldthwaite which would result in somewhat less control of the District's own destiny, though this is not a significant disadvantage.

The proposed initial first year improvements would include construction of a new 200 acre/foot reservoir at the existing new reservoir site. This facility would be designed for ease of expansion to a second 200 acre/foot reservoir site for maximization of the existing land area presently owned by the City. The second first year expansion would involve the construction of additional treatment capacity at the water treatment plant in the amount of approximately 300 gallons per minute. In latter years the pump station facilities at each of the reservoir sites as well as the raw water intake would be increased in capacity to handle the new flows. These improvements could be staged over a several year period. The attached table gives a cost estimate for the construction of the initial facilities as compared to the two other alternatives which will be discussed below.

6.2.2 San Saba River

The second alternative is for the District to construct a raw water diversion point from the San Saba River just downstream of the City of San Saba. This would require the construction of a pump station and raw water line to be constructed from this diversion point up Highway 16, cross the Colorado River, and tie into the existing 8-inch water line in the vicinity of the old City of Goldthwaite reservoir. This is a distance of approximately 15 miles.

Initial improvements would call for the construction of a raw water diversion point along the San Saba River, construction of approximately 15 miles of raw water line from this diversion point to a tie-in with the existing water line and thirdly would be the construction, as in Alternative 1, of additional water treatment plant capacity at the existing City of Goldthwaite water treatment plant site. This new source of water could supplement the City's existing raw water diversion from the Colorado River and also be stored in the City's reservoir site. The San Saba River, as previously discussed, shows a more consistent and higher quality water than that typically found in the Colorado River. The total dissolved solids in the San Saba River are lower than those typically found in the Colorado River and this

quality could be used to mix with the City's existing water source in the reservoir facilities to enhance this quality. Because of the San Saba River's more consistent water supply, the need to depend on the reservoir's storage in the existing system would not be as great.

Proposed for the initial improvements would be the construction of a 300 gallon per minute pump station on the San Saba River, construction of approximately 15 miles of 8-inch pipeline from the San Saba River to tie into the existing City of Goldthwaite raw water line, and construction of a 300 gpm expansion at the City of Goldthwaite's filtration plant.

The advantages of this alternative would be (1) the better quality raw water to be obtained from the San Saba River, (2) the more consistent flow patterns present along the river, (3) the advantage of not having to construct additional off-line storage reservoirs, and (4) the alternative raw water source that could be used to backup the existing Colorado River pump station.

The disadvantages of this alternative would include (1) the need to obtain property and easements for the construction of these facilities, (2) the necessity to negotiate and amend the City of Goldthwaite's existing raw

water contract to allow for a second diversion from the San Saba River, and (3) the political implications of obtaining a water supply for use in Mills County outside of the limits of Mills County.

6.2.3 Groundwater Development

The third alternative for consideration of a water source for development would be to develop and construct a water well in San Saba County into the Hickory Underground Aquifer for use in Mills County as a source of water. As previously discussed, the limits of the Hickory extend to approximately 4 to 5 miles from the edge of the Colorado River in San Saba County. Construction by other water districts and municipalities have generated sufficient data to indicate that the development of a well in this location could provide adequate water to serve the immediate and long-term needs of the Fox Crossing Water District. As with the development of any well of the size and capacity that would be required for this project, it is difficult to determine whether the acquisition of suitable land and location could be easily obtained to allow the construction for this project. Additionally, as with any groundwater project there is a question of chance in the ability to fully develop a well field as determined by preliminary tests and measurements. Finally, as has

been previously discussed, the naturally occurring radiation within the Hickory Aquifer would need to be either treated to remove this contamination or to obtain waivers from the Texas Department of Health to allow the development of such a source. With the new emphasis of more stringent Federal and State water quality standards, it may be a difficult task to obtain such a waiver. The radiation can be removed by conventional treatment processes but these concentrate the radiation and produce a further problem by attempting to dispose of these waste products in an approved manner.

Assuming a waiver of drinking water standards could be obtained, the proposed facilities for construction would be to construct a 600 gpm well and pumps, ground storage tank of approximately 50,000 gallon capacity and two (2) transfer pumps to pump the water from the ground storage tank into the system. A treated water line would need to be constructed from the well site across the Colorado River and tie into the existing City of Goldthwaite potable water system.

The positive aspects of this alternative are (1) the ability to provide adequate water quantities from this location, (2) the groundwater sources are generally more dependable in periods of drought than surface water

supplies, and (3) the ability to develop a separate supply system from the City of Goldthwaite's existing supply and treatment system.

The negative aspects are (1) the quality limitations of the radiation, (2) the uncertainty of acquiring and developing a satisfactory well supply, (3) the uncertain potential of developing the aquifer, (4) potential problems that may develop in mixing the water between the ground and surface water supply within the City's system, and (5) the single source of water supply to be developed and the lack of a dependable backup alternative.

6.3 Alternative Selection

Based on an analysis of these three alternatives, their relative costs and merits (see Table 6.1), it appears that the most cost-effective immediate solution would be to further develop the City of Goldthwaite's existing water system. This offers the most immediate and cost-effective alternative to providing water to Fox Crossing Water District. The ability to add a second diversion point as a second alternative is not ruled out by the construction of alternative one and this would leave the District with the ability for future water system development. The relative cost of the development of a groundwater system

from the Hickory does not appear as economical even with considering a waiver of the existing water quality standards and other construction limitations imposed by such a system.

TABLE 6.1

Alternative Analysis

Project Cost Estimates -
Fox Crossing Water System Improvements
Water Supply and Treatment

Alternative 1 - Expansion to City of Goldthwaite System

Holding Reservoir Improvements	\$ 500,000
200 A-F Reservoir	
Piping	
New City Reservoir Pump Improvements	
Filter Plant Expansion (300 GPM)	500,000
Clarifiers	
Filters	
Clearwell	
High Service Pumps	
Construction Cost Subtotal	<u>\$1,000,000</u>

Alternative 2 - San Saba River Pump-Over

San Saba River Pump Station	\$ 300,000
Pump Station (300 GPM)	
Raw Water Line	650,000
Filter Plant Expansion (300 GPM)	500,000
Clarifiers	
Filters	
Clearwell	
High Service Pumps	
Construction Cost Subtotal	<u>\$1,450,000</u>

Alternative 3 - Hickory Groundwater Development

Well Development	\$ 600,000
Well Construction	
Well Pump (300 GPM)	
GST and Pump Station	
Site Improvements	
Water Transmission Main	750,000
8" Water Line	
River Crossing	
Intermediate GST and Pump Station	<u>150,000</u>
Construction Cost Subtotal	<u>\$1,500,000</u>

TABLE 6.2

Water Transmission and Distribution Improvements

<u>Year</u>	<u>Estimated Connections Served</u>	<u>Project Cost Estimates</u>
1	263	\$1,340,000
2	97	1,440,000
3	128	1,270,000
4	112	1,320,000
5	73	1,500,000
6	67	1,180,000
7	63	1,465,000
8	<u>54</u>	<u>1,450,000</u>
Total	857	\$10,965,000

Project cost estimates include 30% for contingency, engineering, legal and fiscal.

TABLE 6.3

System Production Improvements

<u>Year</u>	<u>Proposed Improvements</u>	<u>Estimated Project Cost</u>
1	Raw Water Reservoir (200 A-F), 300 GPM Water Treatment Plant, Related System Improvements	\$1,300,000
2	Reservoir Pump Station Improvements, System Pumping and Storage Improve- ments	390,000
3	Water Treatment Plant Expansion (300 GPM)	650,000
4	Raw Water Reservoir (200 A-F) Expan- sion, Related System Improvements	890,000
5	Raw Water Intake and Water Line Improvements	260,000
6	System Pump Station and Storage Improvements	260,000
7	System Pump Station and Storage Improvements	260,000
8	System Pump Station and Storage Improvements	<u>260,000</u>
	Total	\$ 4,270,000

TABLE 6.4

Projected Improvements Estimated Cost Schedule

<u>Year</u>	<u>Waterline Costs(a)</u>	<u>Production Costs</u>	<u>Total Costs(d)</u>	<u>Service Conn.(b)</u>	<u>Cummulative Total Cost</u>	<u>Cummulative Total Conn.(c)</u>	<u>Cost/Conn. \$/Conn.</u>
1	\$1,340	\$1,300	\$2,650	263	\$ 2,640	263	\$10,040
2	1,440	390	1,830	97	4,470	360	12,420
3	1,270	650	1,920	128	6,390	488	13,100
4	1,320	890	2,210	112	8,600	600	14,330
5	1,500	260	1,760	73	10,360	673	15,390
6	1,180	260	1,440	67	11,800	740	15,950
7	1,465	260	1,725	63	13,525	803	16,840
8	1,450	260	1,710	54	15,235	857	17,780

(a) Cost estimates are reflected in thousands.

(b) Service connections based on estimates from tax maps and telephone/electric utilities.

(c) Customer base assumes no growth in areas previously served.

(d) Cost estimates include 30% for contingency, engineering, legal and fiscal.

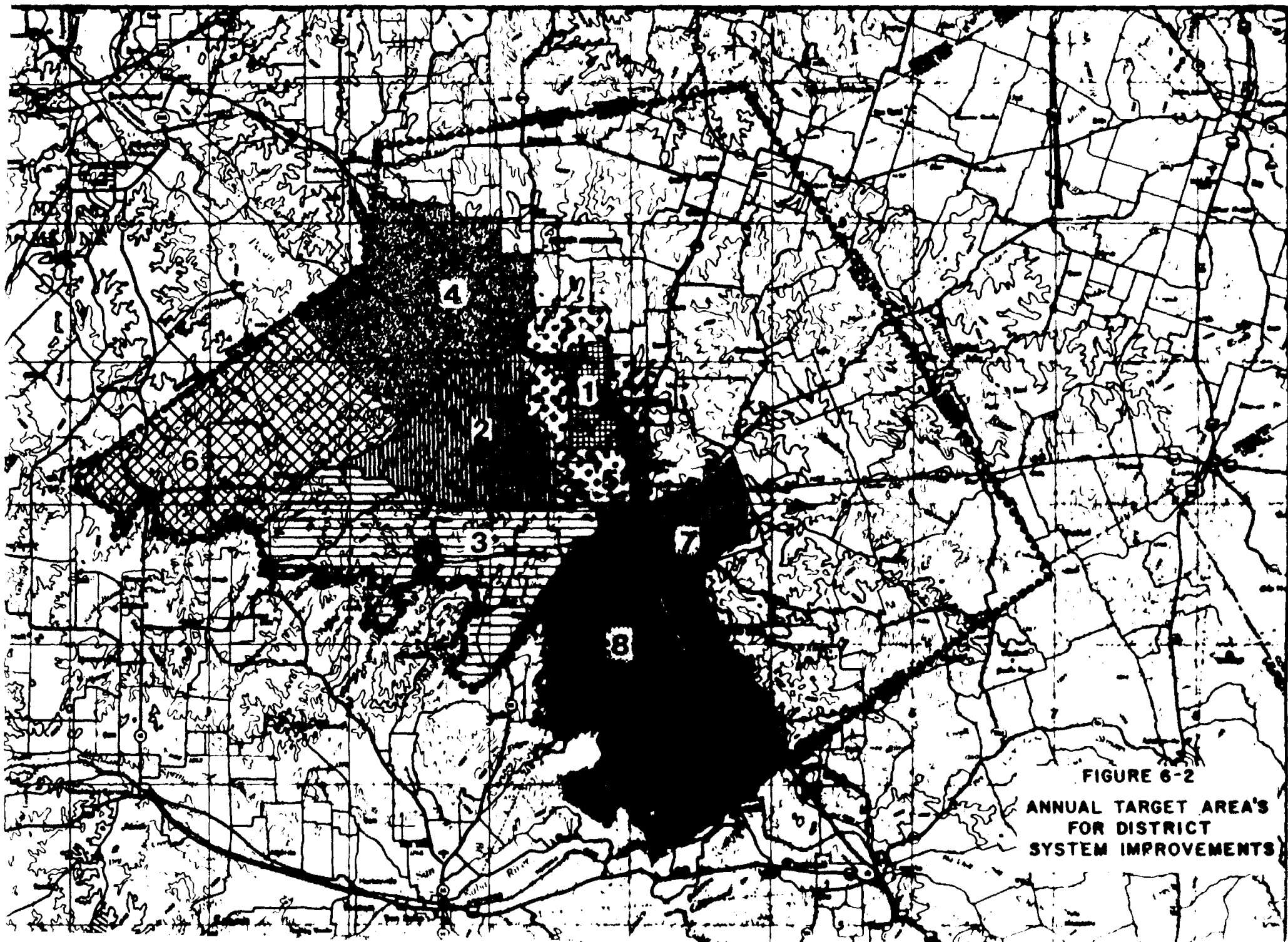

FIGURE 6-2
ANNUAL TARGET AREA'S
FOR DISTRICT
SYSTEM IMPROVEMENTS

6.4 Distribution System Planning

With the development of a raw water supply and treatment scenario, the water must be distributed in adequate quantities and pressures to the rural residents and customers. Information on the location and number of this rural population was obtained through the Mills County Tax Appraisal District and the local telephone and electric company service records. The proposed lines have been sized to handle the existing service population as well as some nominal oversize. The lines would be constructed in accordance with Texas Department of Health requirements and specifications. Cost estimates for line construction were obtained from area contractors with experience in constructing rural water systems of this type. The initial direction of lines will be from Goldthwaite toward the City of Mullin area and then future lines will be constructed each year to the south and west of Goldthwaite, eventually serving the western half and finally the total population of Mills County. The selection and routing of line sizes was done based on the number of service connections that could be brought on-line in the quickest time possible to allow for a revenue base to pay for the proposed improvements. The attached figure shows a yearly plan of the areas to be served for a preliminary 8-year estimate. This plan

should be updated as construction begins and annual planning done to determine the need to serve each area. An annual cost estimate for the proposed improvements is also included. It is anticipated that for the initial service area and periods, the City of Goldthwaite's existing storage capacity and service elevations would be sufficient to serve the initial customers. Future storage and pumping facilities would need to be constructed after the initial service year.

7.0 IMPLEMENTATION PLAN

7.1 Introduction

Now that a proposed service plan has been developed, the means to implement the service program must also be planned and developed. The recommended alternative of supplementing and adding additional capacity to the existing City of Goldthwaite raw water supply and treatment system will help the District keep down the initial cost of system development. With these improvements, distribution system lines will be required to transfer the water from the City of Goldthwaite's storage facilities to the customers in the outlying rural areas. The long runs between customers and sparse rural population will effect the project cost. The projected average cost per connection will be in the range of \$15,000 to \$20,000 per customer. These costs coupled with the area's low economic conditions would place a severe hardship on the area residents and make the practicality of developing such a system unrealistic. Therefore, in order to adequately develop a regional service plan, suitable funding must be arranged.

7.2

Revenue Note Projections

Since the project must be funded on a user-generated revenue basis rather than area-wide taxing notes, it is most likely that grant funding will need to be received in order to fully implement the program. The following table shows a projected proforma for an average customer based on a \$20,000 initial cost for service, a cost of \$2.00 per 1,000 gallons for water usage (10,000 gallons/mo. average), and a 75% grant funding for the initial construction of the facilities, would result in a monthly water bill to the customers of approximately \$70.00 per month to include both water usage as well as financing of the capital improvements. Based on these projected costs and the speculation about the ability to receive 75% to 100% grant funding, the District will need to survey the proposed customer base to determine how a \$70.00 monthly water bill would be accepted and whether suitable customers can be found to support such a system. In addition to seeking Texas Water Development Board funding alternatives, the District should immediately make application for grant funding from the federal Farmer's Home Administration as well as the Texas Department of Commerce.

TABLE 7.1

Revenue Note Projections

Assumptions:

Average Cost of Service - \$20,000 per connection
 Monthly Water Usage - 10,000 gallons/connection
 Cost of Water Service - \$2 per 1000 gallons
 Grant Assumptions - 0, 25, 50, 75 percent funding
 Amortization Period - 20 years
 Interest Period - 10 percent

Grant Funding	0%	25%	50%	75%
Cost Necessary to Fund	\$20,000	\$15,000	\$10,000	\$5,000
Monthly Cost (20 yr. @ 10%)	\$196	\$147	\$98	\$49
Water Usage Cost per month	\$20	\$20	\$20	\$20
Estimated Monthly Cost	\$216	\$167	\$118	\$69

7.3 Project Implementation

Following completion of this draft report the District should proceed with a public hearing process to evaluate the amount of area-wide support for such a system. Based on positive results of such a survey the District should modify this plan accordingly and, with its engineers, attorney and financial advisors, begin an application and review process of the available funding sources to finance the implementation of the service program. A first year project bond pro forma is attached.

TABLE 7.2

First Year Project Bond Pro Forma

Construction Cost Items

Water Distribution Improvements	\$1,030,770	
Production Improvements	<u>1,000,000</u>	
Estimated Construction Cost	\$2,030,770	
Construction Contingency (10%)	203,800	
Engineering (10%)	203,800	
Survey and Easements (2%)	<u>40,630</u>	
Total Construction Cost Estimate		\$2,479,000

Non-Construction Cost

Bond Issuance Cost (Legal & Fiscal) (5%)	\$ 132,000	
Miscellaneous Administrative (1%)	<u>29,000</u>	
Total Non-Construction Cost Estimate		\$ <u>161,000</u>
Total Project Cost Estimate		\$2,640,000

7.4 Additional Considerations

In addition to the implementation planning and administration of a construction program to provide water service to the customers, the District also has an important role in the implementation, planning and education of the area residents of the need to protect and develop water resources for the area. There are several programs that the District has already begun to consider and should continue to research and develop.

7.5 Wellhead Protection

A wellhead protection program that involves the proper construction of existing wells and protection of those wells already constructed, also the capping and plugging of abandoned wells that may lead to contamination of the existing area wells and groundwater reserves. Another occurrence is the identification of salt or brackish water wells from abandoned petroleum exploration programs which need to be capped and plugged to prevent the contamination of surface water sources from such a program. The District has begun discussions with the Lower Colorado River Authority to implement and fund these programs. Also, it is necessary through area newspaper articles and mail-outs that further education and involvement with the community will help to identify, encourage and develop a wellhead protection program.

7.6 Non-Point Source Pollution Control

Another important consideration is the education and development of a non-point source pollution program. This type of program will be to protect surface water runoff and contamination of the area's existing water resources. It is particularly important in the agricultural community with the potential for surface water contamination by

fertilizers, pesticides, and livestock feedlot runoff. These contaminants could not only effect the individual agricultural community but also the downstream users of such a program. It is only through educational involvement and identification of these programs that a suitable plan for control can be developed.

7.7 Water System Conservation

Thirdly, as discussed in the appendices of this report is the need to develop an area-wide water conservation program. With the area's limited water resources, this type of program is even more important. It has been demonstrated that by education and customer awareness of the need to conserve water that significant reductions in usage can be achieved. This effort is further discussed in the appendices of this report.

7.8 Water Resource Development

Finally, initial discussions with the local office of the Soil Conservation Service have been held on the possibilities of the development of a possible reservoir site for the area. Development of a major reservoir would enhance water resource and recreational use for the area. Preliminary discussions to date have revolved around the

possibilities of reservoir locations on Pecan Bayou, the Colorado River or other major tributaries that traverse the County. The Pecan Bayou site looks particularly favorable. It is felt that development of such a resource would greatly enhance the area's water quality prospects and provide a significant benefit to the County. This would be a long-term program and suitable options must be explored to assess the costs, benefit and environmental considerations that development of such a project would require.

7.9 System Planning

Finally, as discussed in this report, regular planning and updating of the population growth projections and economic and water service needs of the area must be performed on a regular basis. These planning tools provide abundant information that will be the basis for guiding the District in the planning and implementation of the required facilities and programs to best serve the area's customers and residents. As new programs and services are provided, the potential for new growth and development will occur that can greatly change the projections and assumptions that have become the basis of this report. Only through the regular updating and review of these programs can the District ensure that these programs continue to develop and are administered properly.

APPENDIX A

Water Conservation and
Drought Contingency Planning

WATER CONSERVATION AND DROUGHT CONTINGENCY PLANNING

1.0

INTRODUCTION

The Texas Administrative Code (TAC) 31 Section 355.15(b)(7) under which the District has received funding for this study, requires that a water conservation plan be developed as a part of the effort. This is not only a requirement, it's good sense. Water is our most important natural resource, and probably the most abused. A water conservation plan should be developed and implemented for every water supply service area, regardless of whether they are currently subject to shortages. This school of thought is evident in recent policy changes at the Texas Water Development Board and the Lower Colorado River Authority.

While the supply of clean, usable water has steadily declined over the past thirty years, the per capita water use has increased by about four gallons per person per day per decade. In many areas of the Country, water is in such short supply that mandatory water rationing and restrictions have become a part of everyday life. Mills County currently suffers from a lack of adequately developed water source and supply. Development of these available resources must be carefully managed to ensure adequate protection and safeguards.

Water conservation for the Study Area is a two step process. The first step is a water conservation plan utilizing techniques such as public education and awareness, local building and planning codes to reduce water consumption, and rate structures which discourage excessive water use. The second step is called a drought contingency plan. This step includes mandatory measures aimed at reducing water consumption to a level consistent with available supplies. A drought contingency plan may include such measures as economic incentives for conservation or penalties for excessive use, restrictions on non-essential water uses, and in extreme cases, civil enforcement of emergency water rationing regulations. The idea of course is that if the first step measures are followed, then hopefully the second step will not be necessary. However, extremely dry weather conditions or a catastrophic impact on the Colorado River could require a drought contingency plan to be implemented regardless of how well a general water conservation plan is followed.

Water conservation policies are currently in effect in many areas of the Country, including Texas. Reductions in residential, commercial, and industrial water use can be as high as 25 percent with conservation measures, however a reduction of 5 to 15 percent is more typical. A drought contingency plan, which includes more serious conservation

measures, can reduce water usage by 50 percent during emergency conditions.

Cutting down on water use can have significant impacts. Obviously, it will lower water bills; but since much of the water saved is hot water, it also means energy savings. Less water consumption can also mean smaller and longer lasting septic tanks or other on-site wastewater treatment systems. For centralized water and wastewater collection systems, water savings can translate into smaller facilities or longer intervals between phases. Water conservation can also have a negative effect on some suppliers which depend upon water sales to generate revenues. The full impacts of water conservation however, are much more far reaching.

One of the less obvious benefits of water conservation is decreased wastewater production. With an effective conservation program, the costs of wastewater treatment and sludge disposal are often reduced. Until conservation effects are adequately documented, wastewater systems are usually required to be designed for peak flows and no real savings are seen. When water and wastewater facility costs are reduced, taxes and utility bills should be lowered. Risks associated with wastewater pollution of surface and ground waters are reduced.

2.0

LONG TERM WATER CONSERVATION PLAN

In home water use accounts for approximately 65 percent of total residential use. The remaining 35 percent is used for exterior uses such as lawn watering and car washing. Several methods of water conservation will be examined in this section. They include:

2.1

Reducing Water Use Through Education and Information (i.e. changing water use habits).

The most important part of any water conservation plan is public education and acceptance. No plan can be effective without adequate public support. The key to gaining acceptance is through education. The end users in a water supply system must understand both the long term benefits of conservation as well as the immediate impacts upon their water bill. Public education can not be accomplished in a single effort. This is where many authorities fall short in implementing conservation measures. Conservation policies can be legally enacted much faster than they can effectively be implemented. It is a slow, gradual, on going process that must continually be stressed until it becomes habit.

The District will inform customers of various recommended methods for implementing a reduction in water consumption. Generally, a majority of water consumption in the District is consumed by residential customers. Therefore, the target area for educational information is to be the majority user and also contract customers.

a. First year program or activities will consist of eight activities:

1. A Fact Sheet explaining the Conservation Plan will be developed and distributed.
2. An article will be placed in newspaper, correlated with Fact Sheet distribution.
3. Provide each new customer with "Homeowner's Guide to Water Use and Water Conservation."
4. Newspaper article advising water customers that Homeowner's Guide is available through the District.
5. Mail out one brochure to water customers - "Water...Half-A-Hundred Ways to Save It."
6. News article elaborating on brochure items.
7. Mail out one brochure to water customers either "How to Save Water Outside the Home," or "How to Save Water Inside the Home."
8. News article in newspaper highlighting certain methods for saving water.

b. Long-term program will consist of five activities each year after first year:

1. Mail out new brochures emphasizing new or innovated means for conserving water.
2. Newspaper article targeting one particular household water using utility or item and method for conserving water (dishwasher, shower, toilet, laundry).
3. Brochure relating to outside household use, car washing, lawn watering, time of day, correlated to weather predictions.
4. Newspaper item correlated to brochure mail out.
5. Continue distribution of Homeowner's Guide to customers.

c. New customers will be advised of Conservation Program and provided with a copy of Homeowner's Guide.

The District will resource materials available from the Texas Water Development Board and other agencies or organizations which develop desirable pertinent information or data.

2.2 Use of Water Saving Devices and Appliances by Existing Customers.

Approximately 40 percent of the total in-home residential water useage is used in toilet flushing and another 35 percent is used for bathing. The difference between using 50 gallons of water a day as opposed to 80 gallons a day may be as simple and inexpensive as installing a flow restricting device in the shower head and water filled plastic bottle to displace water in the toilet. Tests with such devices have proven successful in saving water and have presented no inconvenience or significant adjustments for the people using them. Being conscious of the use of water and making small changes in personal habits, like taking shorter showers and not letting water run while washing dishes, can result in even greater water savings.

For one person, the typical five gallon flush toilet contaminates about 13,000 gallons of fresh water each year to move only 165 gallons of actual waste. Through the use of toilet dams, tank displacement devices, and low flush toilets, the average flush can be reduced to 3.5 gallons or less; a savings of approximately 2,740 gallons per person, or 8,760 gallons per year for an average family.

After the toilet, the heaviest water user in the house is the shower. Approximately 30 percent of the total household water consumption goes for showering and bathing; roughly 80 gallons a day for a family of four. Flow rates in shower heads generally vary from 3 gpm to 10 gpm.

Sizeable water savings can be obtained by installing a flow restricter for shower heads (and also for sink faucets). Because flow restricters increase water velocity, the reduction in water volume is usually not noticeable, yet water savings are in the neighborhood of 30 to 50 gallons per day. Assuming a savings of 30 gallons per day, the yearly amount of water savings would be approximately 10,950 gallons.

Faucet aerators mix air with the water as it leaves the faucet. This gives the illusion of more water flowing

from the tap than actually is. Faucet aerators are inexpensive, easy to install, and most types use about 50 percent of the water of a regular faucet.

Automatic clothes washing machines account for about 15 percent of the water consumed in households where they are present. Top loading models which are most common require about 35 to 50 gallons per cycle. Water (and energy) savings can be achieved by using the proper water and temperature setting for the size and type of load being washed. Many appliance makers offer models which use less water and energy to clean an equivalent load. Publications such as Consumer Reports can be helpful in comparing conservation features when purchasing a washer.

2.3 Revising Plumbing Codes to Encourage the Use of Water Conservation Devices and Appliances in New Construction and Remodeling.

Institution or revision of plumbing codes to require the use of water saving devices and appliances in new home construction is perhaps the most effective method of achieving long term flow reduction within a community. Prior to the adoption of code revisions, a comprehensive study should be done to research specific items available on the market and determine which ones are effective (and cost effective) enough to mandate specifying in new home construction. This process can be simplified somewhat by

obtaining copies of similar codes already being used in other communities to use as a beginning point. This product evaluation needs to be updated periodically as products are introduced and redesigned.

Obviously, revision of the existing plumbing code will require the cooperation of area developers. Although one of the side effects of a plumbing code revision of this type may be to slightly increase the price of a new home, it is hoped that the long term benefits of lower net utility bills and fewer tax increases will outweigh this price increase. Also, it should be noted that a flow reduction program can make up to 23% more wastewater service available for proposed development. This is particularly important in developing rural areas where water and wastewater service may be the limiting factor on growth.

Attachment No. 4 hereto, is an excerpt from the City of Austin Plumbing Code which is used as an example of a typical plumbing requirement. This Ordinance has adopted Section 912 Water Conservation, of the Uniform Plumbing Code.

2.4 Retrofit Programs to Improve Water Use Efficiency in Existing Buildings or Appliances.

With the development of a regional water system, the District should encourage customers to utilize low demand fixtures and appliances through proposed educational sources described in this Plan. The District will advise customers of low water demand items, shower heads, toilet dams, etc., by mail outs and/or publication of newspaper articles, emphasizing the importance of water saving devices. The District will contact local suppliers of plumbing supplies advising suppliers of water saving drive content. Suppliers will be requested to stock low water fixtures and low water use items.

Incentives can also be incorporated into utility rate structures to encourage customers to replace their existing appliances with less water intensive models. Local regulatory authorities which review and approve remodeling projects should be urged to require water saving appliances in all reconstruction.

2.5 Rate Incentives Which Encourage Conservation.

Rate incentives intended to encourage participation in flow reduction programs can either be positive or negative in nature. Positive incentives, such as lower rates or rebates on utility bills for retrofiting existing homes and businesses with water saving devices or appliances,

can be effective in reducing flow in communities where a great deal of the development has already taken place. This form of incentive however, can also reduce the supplier's revenue from water sales and should be examined carefully to determine the true cost effectiveness of this portion of the program.

Negative rate incentives are seldom popular and should be used as a last resort. Arbitrarily raising water rates in order to promote conservation can produce many negative side effects which can outweigh the effectiveness of the incentive. Changes in pricing structure from the traditional declining block rate to either a uniform unit rate or increasing block rate can achieve the same results with less opposition. As the District develops its service plan, a rate study to insure adequate cost recovery for operation and maintenance as well as encourage water conservation is recommended.

2.6 Conservation Oriented Landscaping and Outdoor Water Use.

Only about 46% of residential water makes its way into the sanitary sewer system. The remaining 54% is used for outdoor uses such as landscape maintenance and car washing. Changing the public's attitudes about landscaping can have significant effects upon the amount of residential (and commercial) water use. Virtually all of residential outdoor water use consists of watering vegetation. Choices

made in selecting lawn grasses, trees, and shrubs are probably the most important factor in the effectiveness of outdoor conservation measures.

Xeriscaping, the use of native plants in landscaping, can provide lawns that are not only attractive but are also less labor and water intensive and blend with the surrounding environment. Planting, or leaving existing, native trees rather than using fast growing, short life, exotic species should be encouraged whenever possible. Less water intensive grasses such as Bermuda should be suggested instead of varieties like St. Augustine which require constant attention and abundant amounts of water.

Many attractive native species of shrubs and trees are available from local nurseries. Some suggested tree varieties include Live Oak, Texas (Spanish) Oak, Shumard (Red) Oak, Redbud, Little Walnut, Flameleaf Sumac, Texas (Mexican) Persimmon, and the Texas Mountain Laurel. Many hardwoods such as Oaks, which are usually considered slow growing are capable of fairly rapid growth with the added moisture provided by typical lawn watering.

Much of the Study Area will be developed as ranchettes or acreage tracts. These larger Hill Country lots are easily maintained as natural areas. By leaving the existing

vegetation and topography intact, the natural environment is preserved and a majority of the site is maintenance free. This concept should be encouraged whenever possible.

Another area in which outdoor water use can be reduced is the methods in which vegetation is watered. The typical "set and forget" method of lawn watering can be inefficient and expensive. Hand watering, when possible, is the most efficient way to get the proper amount of water where it is needed most. Soaker hoses can be an efficient way to distribute water because they are not as subject to evaporation. Sprinkler types which offer greater flexibility in directing spray allow the user to water more of the yard and less of the sidewalk. Automatic sprinkler systems, when used properly can be one of the most efficient methods of watering because the duration can be timed and the application can be timed to occur in the early morning when evaporation is less and water pressure is best. Automatic sprinkler systems must be monitored however to be sure they don't water when it is not needed. Otherwise, they can be as wasteful as they are efficient. Commercial systems are especially guilty of this. Watering is most efficient in the early morning while the ground and air are still cool and should be avoided on especially windy days if possible. Perhaps

most important is to apply the correct amount of water. Watering less, more frequently, will benefit vegetation much more than overwatering periodically.

The development of the Fox Crossing Water District will be for residential water service. However, agricultural water usage can also greatly benefit from a conservation program in livestock and farming applications. Extensive research has been done by the Texas Agricultural Extension Service for the development of these programs. They can result in higher production and more profitable agricultural efforts.

Educational material will include information relating to low water use landscaping. The District will review and approve new construction plans. Subdividers and builders, at the time Building Permits are acquired, will be provided with literature pertaining to low water demand landscaping items. Area nurseries will also be provided with mentioned literature.

2.7 Installation, Monitoring, and Repair of Meters.

Effective metering is the key to monitoring water use and conservation measures. Metering key points in the system, combined with water sale records can indicate areas of water losses which might otherwise go undetected. Because

of the nature of fractured limestone, major water leaks can pour hundreds of thousands of gallons of water into underground cracks and porous rock without any surface signs. When leaks are indicated through metering records, a leak detection program should be instituted to pinpoint the exact location so repairs can be made. As with any equipment, the data is only as accurate as the meter which produces it. Meter replacement is currently included in the District's regular maintenance program.

This should be implemented by the District. Universal metering should be initiated within six (6) months after adoption of this Plan. Meter Readers will classify apparent condition of all District meters during the following six months. During this same period, all meters larger than one inch (1") will be tested, and retested each year thereafter. The second year, a Testing Program will be initiated for all meters 1" and smaller. Repairing is to begin in areas with poor classification rated by Meter Readers. Proposed plan will provide testing of all meters 1" and smaller, during a period not to exceed ten years. Annual testing of large meters, testing, maintaining, and replacement of inoperative meters will enable water consumption to be tracked; thus providing a more efficient conservation plan.

2.8

Instituting a Leak Detection and Repair Program.

With the development of a District Water System, a District Audit System to monitor monthly consumption and will become a major tool in System management. Classification of Meter condition as proposed in this Plan will provide a reliable and effective leak detection program. Unaccounted for water should be reduced by 5% per year for the first two years of the Water Conservation Program. The District is aware that assistance in leak detecting surveys can be obtained from the Texas Water Development Board Staff. The Agency has portable leak detection equipment available for loan and can provide personnel for demonstration of equipment and assist in planning survey programs.

Meter classification and aggressive enactment of current detection program will enable District staff to determine the need for seeking further assistance from use of electronic equipment. Current detection program consists of the following observations and activities:

- a. Leaks reported by customers;
- b. Leak detection by Meter Readers;
- c. Continual checking and servicing of production, pumping and storage facilities;
- d. Quick response by Maintenance Department and staff to reported problems.

2.9

Encouraging Recycling and Reuse of Wastewater.

Reuse of wastewater can sometimes become a method of conserving raw water supplies. Usually these are applications in which treated wastewater instead of surface or ground water is used in agriculture. In some areas, certain industrial users have initiated programs which use treated wastewater or produce wastewater which can be reused or used in agriculture. Because the Study Area does lend itself to significant areas of agricultural and industrial development, recycling and reuse will be important areas for further planning and assistance.

MEANS OF IMPLEMENTATION AND ENFORCEMENT

To be effective, each of these methods must be implemented with a program which not only presents them in an attractive light, but also provides for enforcement measures. Not all methods are applicable to every type or stage of development, however most can be utilized to some degree or another.

The Board of Directors will implement the Plan in accordance with District adoption of the Plan, adoption of Plumbing Codes and revisions thereof as set out in this Plan. Enforcement will be provided by:

- a. Refusing to provide taps for customers who do not meet requirements for Water Conservation fixtures as established by Plumbing Code.
- b. Nonpayment of water bills will initiate prompt discontinuation of service. Service will be disconnected.
- c. Analysis of water rates and adjusting rates to eliminate Conservation Plan abuse.

Any political subdivision and/or wholesale customer contracting for water from the District must have (1) an approved Texas Water Development Board Water Conservation and Drought Contingency Plan in effect or (2) must officially adopt applicable provisions of the District's Water Conservation and Drought Contingency Plan.

4.0

EFFECTS OF WATER CONSERVATION

As can be seen in the following table, indoor water use can be reduced up to 23% through such simple measures as shower head inserts and water saving appliances. When those same percentages of reduction are applied to the projected build out of the Study Area, the full benefits of water conservation can be seen. Table A-1 shows the effects of indoor water conservation measures on overall projected water demand. When the effects of outdoor water conservation are added, potential savings are increased even further.

TABLE A-1

Indoor Residential Water Use And
Water Savings With Conservation

<u>Indoor Water Use</u>	<u>Total Indoor Use (Percent)</u>	<u>Without Conservation (GPCPD)</u>	<u>With Conservation (GPCPD)</u>	<u>Reduction (Percent)</u>
Toilet Flushing	40	25	17.5	30
Bathing	30	20	16.0	21
Lavatory Sink	5	3	3.0	-
Laundry & Dishes	20	13	9.5	27
Drinking & Cooking	5	4	4.0	-
TOTAL	100	65	50.0	23

- NOTES: 1) Original data: USEPA.
 2) With Conservation assumes the use of toilet dams, plastic shower head inserts, and water conserving dishwashers and washing machines.
 3) GPCPD - gallons per capita per day.

Possible Water Demand Reduction
Through Water Conservation Measures(1)

<u>Indoor Water Use</u>	<u>Total Indoor Water Use</u>	<u>Without Conservation (GPD)</u>	<u>With Conservation (GPD)</u>	<u>Reduction (GPD)</u>
Toilet Flushing	40%	2,448,000	1,713,600	734,400
Bathing	30%	1,836,000	1,468,800	367,200
Lavatory Sink	5%	306,000	306,000	0
Laundry & Dishes	20%	1,224,000	795,600	428,400
Drinking & Cooking	5%	306,000	306,000	0
TOTAL	100%	6,120,000	4,590,000	1,530,000

- NOTES: * Original data: USEPA.
 * With Conservation assumes the use of toilet dams, plastic shower head inserts and water conserving dishwashers and washing machines.
 * GPD - gallons per day.
 (1) Projected for the year 2010 (12,240 LUEs @ 500 gpd/LUE)

An effective conservation program can provide immediate and long term benefits to the District as well as the individual consumers. Justification for initiation of such a program can be made in terms of short term or long term benefits but need not be justified by both. Long term monetary benefits to the District can result from postponing expansions of water and wastewater treatment facilities as well as their associated conveyance systems. On the other hand, the short term effect of reducing a community's water use may be to decrease revenues without substantially altering operating costs, since most of the utility's costs are fixed and tied to available capacity. Potential lost revenues can be recovered through the addition of new customers or by rate increases (which generally still result in an overall lower water bill). Potential lost revenues can also be avoided or at least compensated by gradual implementation of this type of program.

Individual users can also benefit in the long run in terms of capacity. Lower fixed costs associated with constructing and operating a smaller facility, or delaying facility expansion, theoretically translate to lower (or smaller increases in) water and wastewater bills as well as property taxes to pay for such improvements.

5.0

ANNUAL REPORTING

The District, through adoption of this Plan, commits to annual monitoring and reporting of its progress in achieving its water conservation goals. The annual report to the customers of the District will contain information describing:

- a. Progress in Conservation Plan implementation.
- b. Public response to plan implementation and operation.
- c. Quantitative effectiveness with reference to:
 - (1) System reduction; and
 - (2) Reduction in customer or per capita use.
- d. List of public information released during the year.

6.0

DROUGHT CONTINGENCY PLAN

The second phase of a comprehensive water conservation program is a Drought Contingency Plan. This plan includes specific emergency provisions which would be enacted in the case of a severe drought or other serious impact on the District's water supply. Because impacts on water supplies can occur rapidly and with little or no warning, planning ahead can save time and valuable resources of water in such an event.

The most obvious circumstance which might require implementation of such a plan is a severe drought which impacts the Colorado River and its watershed. During

the late 1980s, the Colorado River has experienced alarming level fluctuations on several occasions due to UCRA operating characteristics and area weather conditions. Although droughts do not occur suddenly, emergency measures are often not enacted until the situation has reached critical stages. Other circumstances which might call for emergency conservation measures include biological or chemical contamination of water supplies, acts of God, or sabotage affecting water supplies or key water production or distribution components. Although these types of emergencies could be remedied in a shorter period of time, prior planning could make the difference between residents having little water and having no water for several days.

6.1 Drought Contingency Measures

Drought contingency measures can take a variety of forms depending upon the severity of the situation. Measures, generally in the order of implementation include:

- a. Banning non-essential water uses;
- b. Reducing essential usage;
- c. Water rationing;
- d. Enforcement through utility rates;
- e. Enforcement through civil/criminal penalties; and
- f. Location of alternative sources of water.

The Water Conservation and Drought Contingency Ordinance adopted and included as part of this plan, enables the Board of Directors to initiate action that will effectively implement the Plan. The following steps are recommended.

1. Step I.

Step I measures related to mild drought conditions and will initiate the following listed action. (Listed action is volunteered by user):

- a. Develop Information Center and designate information person.**
- b. Advise public of condition and publicize availability of information from Center.**
- c. Encourage voluntary reduction of water use.**
- d. Contact commercial and industrial users and explain necessity for initiation of strict conservation methods.**
- e. Implementation of system oversight and make adjustments as required to meet changing conditions.**

2. Step II.

Step II curtailment is to be initiated by the District on its identifying moderate drought conditions. Listed action is compulsory on users and is intended to prohibit water waste. ("Water Waste" is defined as washing house windows, sidings, eaves, and roof with hose, without the use of a bucket; washing driveways, streets, curbs and gutters, washing vehicles without

cutoff valve and bucket, and unattended sprinkling of landscape shrubs and grass; draining and filling swimming pools and flushing water systems.)

- a. Outdoor residential use of water will be permitted on alternate days. Even number house on even days of the month and odd number house on odd number days. Outdoor residential uses consist of washing vehicles, boats, trailers, landscape sprinkler systems and irrigation, recreational use of sprinklers, outside showers (in parks) and water slides.
- b. The General Manager will monitor system function and establish hours for outside water use, depending upon system performance.
- c. Information Center and publicity elements shall keep public advised of curtailment status.
- d. Commercial and industrial use will be visited to insure volunteered conservation has been initiated.

3. Step III.

Step III curtailment shall be initiated upon existence of severe conditions as determined by the General Manager. The General Manager will ban the use of water for:

- a. Vehicle washing, window washing, outside watering (lawn, shrubs, faucet dripping, garden, etc.)
- b. Public water uses which are not essential for health, safety and sanitary purposes. These uses include: street washing, fire hydrant flushing, filling pools, athletic fields and courses and dust control sprinkling.
- c. Commercial uses not listed and industrial uses will be controlled to the extent dictated by the General Manager.

Businesses requiring water as a basic function of the business, such as nurseries, commercial car wash,

laundromats, high pressure water cleaning, etc., will obtain written permission from the General Manager for intended water use.

The System Priority for water service shall be made on the following basis:

1. Hospitals
2. Residential
3. Schools
4. Industrial
5. Commercial
6. Recreational

6.2 Threshold Condition

The Texas Water Development Board suggests three levels or conditions for determining degree of urgency for initiation of Drought Contingency Plan. These three levels of drought conditions are as follows and relate to the District's system.

1. Mild drought occurs when:
 - a. Average daily water consumption reaches 90% of production capacity.
 - b. Consumption (90%) has existed for a period of three days.
 - c. Weather conditions are to be considered in drought classification determination. Predicted long, cold or dry periods are to be considered in impact analysis.

agreed upon mechanisms, the Plan should include triggers for mild, moderate, and severe conditions. Typical measures for each stage include:

Mild Conditions:

- * Notification and suggestions by mail;
- * Activate information center, call news media;
- * Remind public of condition daily;
- * Initiate voluntary lawn watering schedule;

Moderate Conditions:

- * Mandatory lawn watering schedule;
- * Fines for wasting water;
- * Excessive use fees and surcharges;
- * Prohibit non-essential uses;
- * Request/require help from non-municipal users;

Severe Conditions:

- * Prohibit all outdoor water use;
- * Mandatory water rationing, fines for non-compliance;
- * Decrease/stop water for all non-municipal uses (industry, commercial, etc.).

6.4 Initiation and Termination Procedures

Just as the District must be prepared with established triggering conditions for stages of the Drought Contingency Plan, they must also outline in advance what the initiation and termination procedures of these stages are. By what authority is each phase initiated? What steps will be taken in each phase and in what order? What are the triggering mechanisms that signal the end of a phase? All of these questions should also be addressed in the Plan.

laundromats, high pressure water cleaning, etc., will obtain written permission from the General Manager for intended water use.

The System Priority for water service shall be made on the following basis:

1. Hospitals
2. Residential
3. Schools
4. Industrial
5. Commercial
6. Recreational

6.2 Threshold Condition

The Texas Water Development Board suggests three levels or conditions for determining degree of urgency for initiation of Drought Contingency Plan. These three levels of drought conditions are as follows and relate to the District's system.

1. Mild drought occurs when:

- a. Average daily water consumption reaches 90% of production capacity.
- b. Consumption (90%) has existed for a period of three days.
- c. Weather conditions are to be considered in drought classification determination. Predicted long, cold or dry periods are to be considered in impact analysis.

2. Moderate drought conditions are reached when:
 - a. Average daily water consumption reaches 100% of rated production capacity for three day period.
 - b. Weather conditions indicate mild drought will exist five days or more.
 - c. One Ground Storage Tank or one Clearwell is taken out of service during mild drought period.
 - d. Storage capacity (water level) is not being maintained during period of 100% rated production period.
 - e. Existence of any one listed condition for a duration of 35 hours.
3. Severe drought classification is reached when:
 - a. Average daily water consumption reaches 110% of production capacity.
 - b. Average daily water consumption will not enable storage levels to be maintained.
 - c. System demand exceeds available high service pump capacity.
 - d. Any two conditions listed in moderate drought classification occurs at the same time for a 24 hour period.
 - e. Water system is contaminated either accidentally or intentionally. Severe condition is reached immediately upon detection.
 - f. Water system fails -- from acts of God, (tornados, hurricanes) or man. Severe condition is reached immediately upon detection.

6.3

Triggering Conditions

The triggering mechanisms for various phases of a Drought Contingency Plan are specific to each utility. They can be tied to river levels, percent of actual vs. projected demand, or other utility specific factors. Whatever the

agreed upon mechanisms, the Plan should include triggers for mild, moderate, and severe conditions. Typical measures for each stage include:

Mild Conditions:

- * Notification and suggestions by mail;
- * Activate information center, call news media;
- * Remind public of condition daily;
- * Initiate voluntary lawn watering schedule;

Moderate Conditions:

- * Mandatory lawn watering schedule;
- * Fines for wasting water;
- * Excessive use fees and surcharges;
- * Prohibit non-essential uses;
- * Request/require help from non-municipal users;

Severe Conditions:

- * Prohibit all outdoor water use;
- * Mandatory water rationing, fines for non-compliance;
- * Decrease/stop water for all non-municipal uses (industry, commercial, etc.).

6.4 Initiation and Termination Procedures

Just as the District must be prepared with established triggering conditions for stages of the Drought Contingency Plan, they must also outline in advance what the initiation and termination procedures of these stages are. By what authority is each phase initiated? What steps will be taken in each phase and in what order? What are the triggering mechanisms that signal the end of a phase? All of these questions should also be addressed in the Plan.

Initiation procedures employed at any period is described in this Plan. Each condition will be met with corresponding action by the District and the District will affect curtailment, give notice, publicize and follow with implementation of curtailment.

Termination of each drought condition will begin when that specific condition has been improved to the extent that an upgraded condition can be declared by the District. This process will be employed until full service can be provided. System priority will be considered in return to upgraded condition, returning hospitals, schools, etc., in priority order.

Termination will be initiated by the District by giving notice, etc. as was given to enact drought curtailment.

6.5 Information and Education

The public will be made aware of conservation and drought conditions by information and data transfer thru the District's annual program. During periods of drought curtailment, Step I conditions establishes an information center, an information person, and utilize the most effective methods developed for information dissemination on a daily basis.

Close observation of the first year information program should develop the most effective ways to communicate with customers. Posting notices, newspaper articles, radio coverage and direct mail to customers will be used during the first year activities.

7.0 MODIFICATION, DELETION AND AMENDMENT

The District can add, delete, and amend rules, regulations and implementation as needed/desired, and shall advise Board of Directors of such amendments at its next regular or called meeting.

8.0 MEANS OF IMPLEMENTATION

Adoption of this Plan, Drought Contingency Ordinance, and modification of Plumbing Code Ordinance will enable the District to implement and carry out enforcement of enacted ordinances to make the Plan effective and workable.

FIGURE A-1
Effects of Water Conservation
On The Planning Area (Graph)

FIGURE A-1
PROJECTED MILLS COUNTY WATER USE

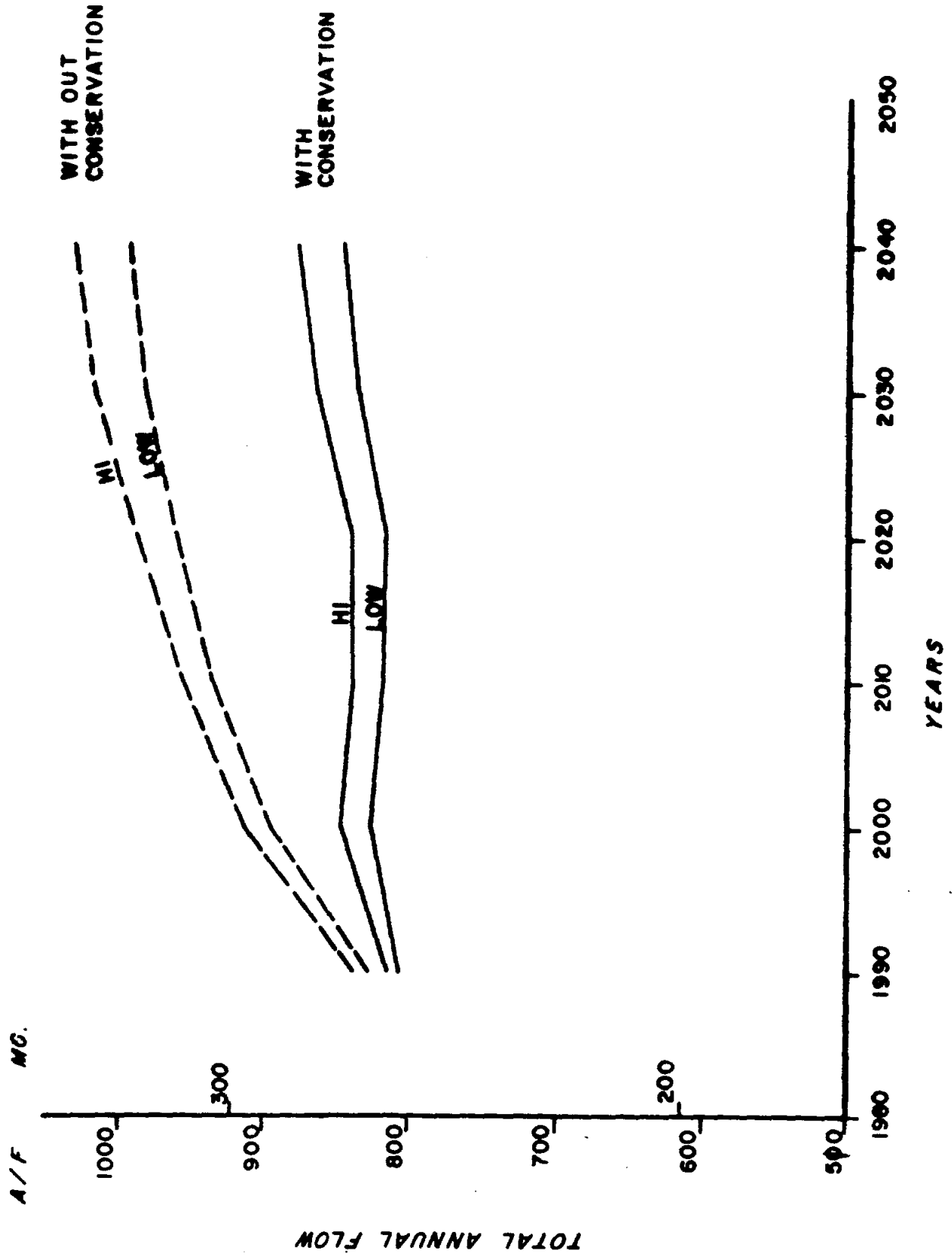

ATTACHMENT NO. 1

Listing of Water Conservation Literature

Texas Water Development Board

**LISTING OF WATER CONSERVATION LITERATURE
TEXAS WATER DEVELOPMENT BOARD**

<u>TITLE</u>	<u>PUBLISHED BY</u>	<u>DESCRIPTION</u>	<u>LENGTH</u>
Water...Half-A-Hundred Ways To Save It*	TWDB	Pamphlet	8 pages
Water Saving Ideas For Business and Industry*	TWDB	Pamphlet	8 pages
How to Save Water Outside The Home	TWDB	Pamphlet	8 pages
How to Save Water Inside The Home*	TWDB	Pamphlet	8 pages
A Homeowner's Guide to Water Use and Water Conservation*	TWDB	Booklet	22 pages
Drip Irrigation*	TWDB	Pamphlet	6 pages
Lawn Watering Guide*	TWDB	3-1/2" X 5" Plastic Card	2 sides
Toilet Tank Leak Detector Tablets*	TWDB	2 Tablets	
Municipal and Commercial Water Conservation Services	TWDB	Pamphlet with Tear-out	8 pages
Guidelines for Municipal Water Conservation and Drought Contingency Planning and Program Development	TWDB	Loose-leaf	36 pages
How to Xeriscape	NXC	Pamphlet	10 pages
Texas Sesquicentennial Native Plant Landscape (located in Austin)	TDB/TWDB	Pamphlet	8 pages
Guide for Locating and Reducing Unaccounted for Water Through the Use of the Water Audit and Leak Detection	TWDB	Guidebook	30 pages
Guide for Designing Conservation Water Rate Structures	TWDB	Guidebook	30 pages

<u>TITLE</u>	<u>PUBLISHED BY</u>	<u>DESCRIPTION</u>	<u>LENGTH</u>
Model Water Ordinances	TWDB	Guidebook	25 pages
The Authority of Cities, Water Utilities, and Water Districts to Regulate and Enforce Water Conservation Measures	TWDB	Paper	5 pages
Texas Water Resources and Conservation	TWDB	Paper	38 pages
Efficient Use of Water in the Garden and Landscape (B-1496)	TAEX	Booklet	20 pages
Xeriscape°	City of Austin	Booklet	20 pages
Water Pressure Reducing Valves°	Watts Regulator	Booklet	21 pages
Texas Native Tree and Plant Directory, 1986°	TDA	Book	161 pages
Sources of Leak Detection Equipment and Services°	TWDB	List	2 pages
Sources of Water Saving Devices°	TWDB	List	21 pages
The Cost of Conventional Water Supply Development and Treatment°	TWDB	Paper	9 pages
Potential for Utilization of Brackish Groundwater°	TWDB	Paper	21 pages
Guidelines for Water Reuse EPA-600/8-80-036°	EPA	Book	105 pages
Guidelines for Municipal Water Conservation and Drought Contingency Planning and Program Development°	TWDB	Loose-leaf	36 pages
Water Conservation and Drought Contingency Plan Development Procedures°	TWDB	Loose-leaf	58 pages
Municipal Water Conservation Workshop Notebook	TWDB	Notebook	6 sections

• These items are available either in single copies or in the Municipal Water Conservation Notebook. However, the Board is not able to give out the Notebook, but can loan a copy for a period of two weeks.

* Order in 1000 Lots.

Abbreviations:

AWWA	American Water Works Association
EPA	Environmental Protection Agency
HPUWCD #1	High Plains Underground Water Conservation District No. 1
NXC	National Xeriscape Council, Inc.
SCS	USDA - Soil Conservation Service
TAEX	Texas Agricultural Extension Service
TDA	Texas Department of Agriculture
TWDB	Texas Water Development Board

ATTACHMENT NO. 2
Public Information Suggestions

PUBLIC INFORMATION SUGGESTIONS

The Texas Administrative Code (TAC) 31 Section 355.15(b)(7) under which the District has received funding for a regional water study, requires that a water conservation plan be developed as a part of the effort. This is not only a requirement, it's good sense. Water is our most important natural resource, and probably the most abused. A water conservation plan should be developed and implemented for every water supply service area, regardless of whether they are currently subject to shortages. This school of thought is evident in recent policy changes at the Texas Water Development Board and the Lower Colorado River Authority.

While the supply of clean, usable water has steadily declined over the past thirty years, the per capita water use has increased by about four gallons per person per day per decade. In many areas of the Country, water is in such short supply that mandatory water rationing and restrictions have become a part of everyday life. Travis County currently enjoys large supplies of fresh water supplied from the Colorado River basin and various underground aquifers. With proper conservation measures, this rich supply will sustain projected County growth well into the twenty first century.

The following water conservation suggestions have been reproduced, in part, from the Texas Water Development Board Bulletin, entitled "Water...Half-A-Hundred Ways to Save It."

-----POSSIBLE SAVINGS WITH WATER CONSERVATION-----

For approximately \$10.00 to \$15.00 the average homeowner can install two low-flow showerheads, place dams or bottles in the toilet tanks, put low-flow aerators on the faucets, and repair dripping faucets and leaking toilets. This could save from 10,000 to 25,000 gallons/year for a family of four, and would pay for itself, in less than a year. Even more water could be saved if good outdoor water conservation is practiced for lawns and gardens.

CONSERVATION TIPS

A. IN THE BATHROOM

1. Take a shower instead of filling the tub and taking a bath. Showers usually use less water than tub baths.
2. Install a low-flow shower head which restricts the quantity of flow at 60 psi to no more than 3.0 gallons per minute.
3. Take short showers and install a cutoff valve or turn the water off while soaping and back on again only to rinse.
4. Do not use hot water when cold will do. Water and energy can be saved by washing hands with soap and cold water; hot water should only be added when hands are especially dirty.
5. Reduce the level of the water being used in a bath tub by one or two inches if a shower is not available.
6. Turn water off when brushing teeth until it is time to rinse.
7. Do not let the water run when washing hands. Instead, hands should be wet, and water should be turned off while soaping and scrubbing and turned on again to rinse. A cutoff valve may also be installed on the faucet.

8. Shampoo hair in the shower. Shampooing in the shower takes only a little more water than is used to shampoo hair during a bath and much less than shampooing and bathing separately.
9. Hold hot water in the basin when shaving instead of letting the faucet continue to run.
10. Test toilets for leaks. To test for leak, a few drops of food coloring can be added to the water in the tank. The toilet should not be flushed. The customer can then watch to see if the coloring appears in the bowl within a few minutes. If it does, the fixture needs adjustment or repair.
11. Use a toilet tank displacement device. A one-gallon plastic milk bottle can be filled with stones or with water, recapped, and placed in the toilet tank. This will reduce the amount of water in the tank, but still provide enough for flushing. (Bricks which some people use for this purpose are not recommended, since they crumble eventually and could damage the working mechanism, necessitating a call to the plumber). Displacement devices should never be used with new low-volume flush toilets.
12. Install faucet aerators to reduce water consumption.
13. Never use the toilet to dispose of cleansing tissues, cigarette butts, or other trash. This can waste a great deal of water and also places an unnecessary load on the sewage treatment plant or septic tank.
14. Install a new low-volume flush toilet that uses 3.5 gallons or less per flush when building a new home or remodeling a bathroom.

B. IN THE KITCHEN

1. Use a pan of water (or place a stopper in the sink) for rinsing pots and pans and cooking implements when cooking, rather than turning on the water faucet each time a rinse is needed.
2. Never run the dishwasher without a full load. In addition to saving water, expensive detergent will last longer and a significant energy savings will appear on the utility bill.
3. Use the sink disposal sparingly, and never use it for just a few scraps.
4. Keep a container of drinking water in the refrigerator. Running water from the tap until it is cool is wasteful. Better still, both water and energy can be saved by keeping cold water in a picnic jug on a kitchen counter to avoid opening the refrigerator door frequently.

5. Use a small pan of cold water when cleaning vegetables rather than letting the faucet run.
6. Use only a little water in the pot and put a lid on it for cooking most food. Not only does this method save water, but food is more nutritious since vitamins and minerals are not poured down the drain with the extra cooking water.
7. Use a pan of water for rinsing when hand washing dishes rather than running the faucet.
8. Always keep water conservation in mind, and think of other ways to save in the kitchen. Small kitchen savings from not making too much coffee or letting ice cubes melt in a sink can add to in a year's time.

C. IN THE LAUNDRY

1. Wash only a full load when using an automatic washing machine (32 to 59 gallons are required per load).
2. Use the lowest water level setting on the washing machine for light loads whenever possible.
3. Use cold water as often as possible to save energy and to conserve the hot water for uses which cold water cannot serve. (This is also better for clothing made of today's synthetic fabrics.)

D. FOR APPLIANCES AND PLUMBING

1. Check water requirements of various models and brands when considering purchasing any new appliances that uses water. Some use less water than others.
2. Check all water line connections and faucets for leaks. If the cost of water is \$1.00 per 1,000 gallons, one could be paying a large bill for water that simply goes down the drain because of leakage. A slow drip can waste as much as 170 gallons of water EACH DAY, or 5,000 gallons per month, and can add as much as \$5.00 per month to the water bill.
3. Learn to replace faucet washers so that drips can be corrected promptly. It is easy to do, costs very little, and can represent a substantial amount saved in plumbing and water bills.
4. Check for water leakage that the customer may be entirely unaware of, such as a leak between the water meter and the house. To check, all indoor and outdoor faucets should be turned off, and the water meter should be checked. If it continues to run or turn, a leak probably exists and needs to be located.

5. Insulate all hot water pipes to avoid the delays (and wasted water) experienced while waiting for the water to "run hot."
6. Be sure the hot water heater thermostat is not set too high. Extremely hot settings waste water and energy because the water often has to be cooled with cold water before it can be used.
7. Use a moisture meter to determine when house plants need water. More plants die from over-watering than from being on the dry side.

E. OUT-OF-DOOR USE

1. Water lawns early in the morning during the hotter summer months. Much of the water used on the lawn can simply evaporate between the sprinkler and the grass.
2. Use a sprinkler that produces large drops of water, rather than a fine mist, to avoid evaporation.
3. Turn soaker hoses so the holes are on the bottom to avoid evaporation.
4. Water slowly for better absorption, and never water in high winds.
5. Forget about watering the streets or walks or driveways. They will never grow a thing.
6. Condition the soil with compost before planting grass or flower beds so that water will soak in, rather than run off.
7. Fertilize lawns at least twice a year for root stimulation. Grass with a good root system makes better use of less water.
8. Learn to know when grass needs watering. If it has turned a dull grey-green or if footprints remain visible, it is time to water.
9. Do not water too frequently. Too much water can overload the soil so that air cannot get to the roots and can encourage plant diseases.
10. Do not over-water. Soil can absorb only so much moisture and the rest simply runs off. A timer will help, and either a kitchen timer or an alarm clock will do. An inch and one-half of water applied once a week will keep most Texas grasses alive and healthy.

11. Operate automatic sprinkler systems only when the demand on the town's water supply is lowest. Set the system to operate between 4:00 a.m. and 6:00 a.m.
12. Do not scalp lawns when mowing during hot weather. Taller grass holds moisture better. Rather, grass should be cut fairly often, so that only 1/2 to 3/4 inch is trimmed off. A better looking lawn will result.
13. Use a watering can or hand water with the hose in small areas of the lawn that need more frequent watering (those near walks or driveways, or in especially hot, sunny spots).
14. Learn what types of grass, shrubbery, and plants do best in the area and in which parts of the lawn, and then plant accordingly. If one has a heavily shaded yard, no amount of water will make roses bloom. In especially dry sections of the state, attractive arrangements of plants that are adapted to arid or semi-arid climates should be chosen.
15. Consider decorating areas of the lawn with rocks, gravel, wood chips, or other materials now available that require no water at all.
16. Do not "sweep" walks and driveways with the hose. Use a broom or rake instead.
17. Use a bucket of soapy water and use the hose only for rinsing when washing the car.

ATTACHMENT NO. 3

Conservation/Drought Contingency Plan Ordinance

ORDINANCE NO. _____

AN ORDINANCE ADOPTING A DISTRICT-WIDE WATER CONSERVATION/AND DROUGHT CONTINGENCY PLAN: PROVIDING A PENALTY OF NOT LESS THAN \$10 PER DAY NOR MORE THAN \$200 PER DAY FOR EACH DAY OF NON-COMPLIANCE AND/OR DISCONNECTION OF WATER SERVICES TO SUCH USERS BY THE DISTRICT: A PUBLIC NEED OF AN EMERGENCY NATURE FOR THE ADOPTION HEREOF ON ONE READING: PROVIDING FOR PUBLICATION AND ORDAINING OTHER MATTERS RELATED TO THE FOREGOING.

BE IT ORDAINED BY THE DISTRICT:

WHEREAS, the Board of Directors has determined there is an urgent need in the best interest of the District to adopt a Water Conservation Plan and Drought Contingency Plan, and the Board of Directors further determines that such public need is of an emergency nature and the legal requirements of two required separate readings of the subject ordinance be dispensed with and waived; and

WHEREAS, the Board of Directors now desires to evidence its approval of the Water Conservation/Drought Contingency Plan and adopt such plan as an official policy of the District; Now, Therefore,

BE IT ORDAINED BY THE DISTRICT:

SECTION 1: Approval of the Plan: The Board of Directors hereby approves and adopts the District's Water Conservation Plan, the Water Conservation/Drought Contingency Plan attached hereto as Exhibit "A" to be included in full as a part of this Ordinance as if recited verbatim herein. The District commits to implement the program according to the procedures set forth in the adopted plan.

SECTION II: The District shall report to the Texas Water Development Board annually on the implementation and effectiveness of the plan in accordance with the outline set forth in the plan.

SECTION III: In regards to implementation and enforcement of the Conservation/Drought Contingency Plan the General Manager is designated as the official responsible for implementation and enforcement, and the following guidelines are adopted:

1. Mild Drought occurs when:

- (a) Average daily water consumption reaches 90% of production capacity.
- (b) Consumption (90%) has existed for a period of three days.
- (c) Weather conditions are to be considered in drought classification determination. Predicted long, cold, or dry periods are to be considered in impact analysis.

2. Moderate Drought conditions are reached when:

- (a) Average daily water consumption reaches 100% of rated production capacity for three day period.
- (b) Weather conditions indicate mild drought will exist five days or more.
- (c) One Ground Storage Tank or one Clearwell is taken out of service during mild drought.
- (d) Storage capacity (water level) is not being maintained during period of 100% rated production period.
- (e) Existence of any preceding conditions listed above for a duration of 36 hours.

3. Severe Drought Classification is reached when:

- (a) Average daily water consumption reaches 110% of production capacity for a 24 hour period.
- (b) Average daily water consumption will not enable storage levels to be maintained.

- (c) System demand exceeds available high service pump capacity.
- (d) Any two conditions listed in Moderate Drought Classification occurs for a 24 hour period.
- (e) Water system is contaminated either accidentally or intentionally. Severe condition is reached immediately upon detection.
- (f) Water system fails -- from acts of God (tornados, hurricanes) or man. Severe condition is reached immediately upon detection.

In the event severe classification conditions persist (Item 3 above) for an extended period of time, the District may ration water usage and/or terminate service to selected users of the system in accordance with the following sequence:

- (1) Recreational Users
- (2) Commercial Users
- (3) Industrial Users
- (4) School Users
- (5) Residential Users
- (6) Hospitals, Public Health and Safety Facilities

SECTION IV: Users of District water except for the District, that do not comply with Section III of this Ordinance shall be subject to a penalty and fine of not less than \$10.00 per day nor more than \$200.00 per day for each day of non-compliance and/or disconnection or discontinuation of water services to such users by the District.

SECTION V: The Board of Directors finds and declares that a sufficient written notice of the date, hour, place and subject of this meeting of the Board of Directors was posted at a designated place

convenient to the public at the District Office for the time required by law preceding this meeting and that such place of posting was readily accessible at all times to the general public; that all of the foregoing was done as required by law; and that this meeting has been open to the public as required by law at all times during which this Ordinance and the subject matter thereof has been discussed, considered and formally acted upon.

The Board of Directors further rectifies, approves and confirms such written notice and the contents and posting thereof.

PASSED AND APPROVED THIS _____ day of _____, 1989.

PRESIDENT _____

SECRETARY _____

ATTACHMENT NO. 4

Amendment to the Plumbing Code

City of Austin Provisions

vent below the floor level and a minimum slope of one-quarter (1/4) inch per foot back to the drain shall be maintained. The return bend used under the drainboard shall be a one piece fitting or an assembly of a forty-five (45) degrees, a ninety (90) degree, and a forty-five (45) degree elbow in the order named.

Deep seal P-traps may be installed under the floor of island fixtures if: (1) the trap size is at least two inches and (2) the trap is vented with a two inch soil pipe to the nearest partition wall with a cleanout installed in the riser and thence through the roof to the open air. Pipe sizing for island fixtures shall be as elsewhere required in this Code.

Section 700

(b) The size, type and location of each interceptor or separator shall be approved by the administrative authority, in accordance with its standards. Except where otherwise specifically permitted, no wastes other than those requiring treatment or separation shall be discharged into any interceptor.

Section 912 Water Conservation

(a) The following maximum flow rates and/or water usage standards shall apply for fixtures in:

- * any new building or structure or portions thereof;
- * additions to existing buildings that provide facilities or shelter for public assembly, education, business, mercantile, institutional, residential occupancy;
- * and hotels, motels, condominiums, day care centers, nursing homes and apartments.

(1) Tank type water closets shall provide a maximum flush not to exceed 3.5 gallons.

(2) Shower heads shall have a maximum flow which does not exceed three gpm at pressure ranges from 20 to 80 psig.

(3) Lavatory and kitchen faucets shall be equipped with flow controllers, aerators or spray taps which result in a maximum delivery not to exceed 2.75 gpm (+ .25 gpm) at pressure ranges from 20 to 80 psig when both hot and cold water supply are in full open position.

(4) Flushometer type water closets shall adequately flush and clean fixtures, and shall discharge no more than three gallons per flush.

(5) Tank type urinals shall have a maximum flush not to exceed three gallons per flush.

(6) Flushometer type urinals shall adequately flush and clean fixtures, and shall discharge not more than one gallon per flush.

(7) Lavatory faucets for public facilities may be equipped with (a) outlet devices which limit the flow of hot water to a maximum of 0.5 gpm, or (b) self-closing valves that limit delivery of hot water to a maximum of 0.25 gpm and delivery of cold water to a maximum of 1.75 gpm for a maximum combined delivery of 2 gpm.

(b) The standards set forth in Section 912a shall not apply to hospitals, laboratories, and any other application where health and safety are dependent upon particular water flow rates. The Building Official shall determine whether application requires exception from these standards. The above standards shall not apply to industrial applications installed pursuant to the Industrial Waste Discharge Ordinance.

(c) Fixture flow-performance requirements shall be rated by data furnished by the equipment supplier or certified under a nationally recognized certification program or rating procedure.

(d) Water conservation standards for existing buildings shall be as established by separate ordinance of the City Council.

Section 1003

(a) To protect the public water supply, a reduced pressure back flow preventer shall be installed on the customer's side of the meter of any service connection supplying water to premises where any toxic substance is handled or where any substance is handled under pressure higher than atmospheric; this backflow preventer is in addition to any such back flow protection within the water user's piping system. The reduced pressure backflow preventer shall be installed above the flood level or finished grade. The backflow preventer shall include process waters and waters originating from the public water supply which have been subject to deterioration in sanitary quality.

Section 1004

(a)(1) Water pipe and fittings shall be of brass, copper, cast iron, galvanized malleable iron, galvanized wrought iron, galvanized steel, polybutylene plastic, CPVC or other approved materials. P.E. or P.V.C. water pipe manufactured to recognized standards may be used for cold water distribution systems outside a building. All materials used in the water supply system, except valves and similar devices shall be of like material, unless otherwise approved by the administrative authority.

(a)(2) Approved plastic water piping installations shall be limited to installations permitted by the Building Code.

ORDINANCE NO. 880114-J

PLUMBING CODE

AN ORDINANCE AMENDING CHAPTER 13-9 OF THE AUSTIN CITY CODE OF 1981; REPEALING THE UNIFORM PLUMBING CODE, 1982 EDITION, AND LOCAL AMENDMENTS TO THE 1982 UNIFORM PLUMBING CODE; ADOPTING BY REFERENCE THE UNIFORM PLUMBING CODE, 1985 EDITION, WITH APPENDIX, PUBLISHED BY THE INTERNATIONAL ASSOCIATION OF PLUMBING AND MECHANICAL OFFICIALS, SAVE AND EXCEPT SPECIFIC SECTIONS DELETED BY THIS ORDINANCE; ADOPTING CERTAIN LOCAL AMENDMENTS TO THE 1985 UNIFORM PLUMBING CODE; DIRECTING THE CITY CLERK TO PUBLISH THE LOCAL AMENDMENTS TO THE 1985 UNIFORM PLUMBING CODE IN A SEPARATE COMPILATION TO BE KNOWN AS "LOCAL AMENDMENTS TO THE UNIFORM PLUMBING CODE, 1985 EDITION"; WAIVING THE RULE REQUIRING THE READING OF ORDINANCES ON THREE (3) SEPARATE DAYS; AND PROVIDING AN EFFECTIVE DATE.

BE IT ORDAINED BY THE CITY COUNCIL OF THE CITY OF AUSTIN:

PART 1. Chapter 13-9 of the Code of the Austin City Code of 1981 is amended by repealing the Uniform Plumbing Code, 1982 Edition with Appendix, published by the International Association of Plumbing and Mechanical Officials, adopted by reference in Section 13-9-1. All local amendments to the Uniform Plumbing Code, 1982 Edition, are also repealed by this ordinance.

PART 2. Chapter 13-9 is further amended to adopt and incorporate by reference as Sec. 13-9-1 the publication known as the Uniform Plumbing Code, 1985 Edition with Appendix, published by the International Association of Plumbing and Mechanical Officials, a copy of which is attached and incorporated into this ordinance as Exhibit "A" (the "1985 Uniform Plumbing Code"), save and except the following numbered sections and appendices which are hereby deleted from the 1985 Uniform Plumbing Code:

Sec. 10.3	Sec. 608(c)	Sec. 1008(c)	Sec. 1305(c)
Sec. 20.4(d)	Sec. 614	Sec. 1101(d)	Sec. 1306(b)
Sec. 20.7	Sec. 708(b)	Sec. 1201	Sec. 1310(d)
Sec. 20.14	Sec. 1004(a)	Sec. 1206	Appendix H
Sec. 119(g)	Sec. 1005(c)	Sec. 1213(b)	Appendix I

PART 3. Chapter 13-9 is further amended to add the following sections as local amendments to the 1985 Uniform Plumbing Code, as follows:

Section 10.3 Scope.

The provisions of this Code shall apply to the erection, installation, alteration, addition, repair, regulation, replacement, maintenance or uses of any plumbing system, except as otherwise provided for in this Code.

APPENDIX B
Environmental

INTRODUCTION

The purpose of this report is to provide preliminary environmental support for the development of a Regional Water Supply Plan for the area encompassed by the boundaries of Mills County and the Fox Crossing Water District. The report is designed to accomplish two primary goals: 1) Provide a preliminary baseline assessment of environmental and cultural features that, under Federal and State regulations may become of concern in the development of regional water supply facilities; and, 2) Identify potential effects and/or constraints to the development of such facilities. Section 2.0 of this report provides an overview of existing and proposed regulatory programs and planning initiatives pertinent to the study area. Section 3.0 presents a preliminary environmental baseline and identified significant environmental features that may be of concern to Federal and State regulatory agencies. Section 4.0 identifies potential environmental effects and/or constraints to the development of water supply facilities. Section 5.0 provides a synopsis of recommended actions. Finally, Section 6.0 provides an overview of the area's predominant climatic conditions.

REGULATORY OVERVIEW

Federal and State environmental regulations are expected to influence the development of water supply facilities within the boundaries of the District. This section reviews Federal regulations, including U.S. Fish and Wildlife Service (FWS) Section 7 consultation for threatened and endangered species; U.S. Corps of Engineers 404 permits for stream crossings; and the National Historic Preservation Act for cultural resources. The only State environmental regulation expected to be of concern is the Texas Antiquities Code which applies to all action taken by political subdivisions of the State of Texas. Table B-1 provides a synopsis of environmental considerations which may be of concern in the development of water supply facilities.

TABLE B-1

**SYNOPSIS OF ENVIRONMENTAL CONSIDERATIONS
ASSOCIATED WITH EXISTING AND PROPOSED
REGULATORY PROGRAMS**

Program	Considerations
Section 7 of the Endangered Species Act of 1973, as amended	<ol style="list-style-type: none">1) Formal Section 7 consultation with FWS and USCE and the applicant may be required prior to issuance of USCE permit or any other Federal Permit.2) It will be the responsibility of the applicant to prove whether or not Federally-Listed species occur in the project area.3) If formal Section 7 consultation is required, schedule delays up to 90 days can be expected.
Corps of Engineers 404 Permit Requirement	<ol style="list-style-type: none">1) A permit is required for pipeline crossings of surface water tributaries and waterways.2) A "general permit" exists which significantly reduces the time and paperwork for pipeline construction authorizations.3) Should have information on potential impacts to cultural resources and threatened or endangered species prior to involvement of Corps.4) Acquisition of Corps' authorization early in process will greatly reduce avenues for special interest group intervention.
Texas Antiquities Code	<ol style="list-style-type: none">1) Applies to actions taken by political subdivisions of the State of Texas.2) Administered by Texas Antiquities Committee.3) Generally requires archaeological survey of area of primary impact, and occasionally, testing of potentially important sites.

TABLE B-1 (Continued)

Program	Considerations
National Historic Preservation Act	<ul style="list-style-type: none"><li data-bbox="688 390 1455 516">4) Sites which are determined to be eligible for formal designation as a State Archaeological Landmark may need preservation and/or mitigation.<li data-bbox="688 552 1455 642">1) Potentially applicable for any Federal action, including permits, funding.<li data-bbox="688 678 1455 768">2) Administered by Texas Historic Commission and State Historic Preservation Officer.<li data-bbox="688 804 1455 993">3) Generally requires archaeological survey of affected areas, and, occasionally, testing of more important sites; in some cases, indirect impact areas must be considered.<li data-bbox="688 1029 1455 1150">4) Sites which are determined to be eligible for the National Register of Historic Places may need preservation and/or mitigation.

2.1 Federal Regulatory Considerations

Section 404 of the Clean Water Act as administered by the U.S. Army Corps of Engineers regulates the placement of dredged (excavated) or fill material in "Waters of the U.S." Waters of the U.S. are defined in Section 404 rather broadly as any body of surface water (such as oceans, bays, rivers), all surface tributary streams with a defined channel (including intermittent waterways), and in-stream impoundments (i.e., lakes and ponds), many off-channel impoundments, and wetlands. "Dredged or fill material" has also been given rather broad meaning to include just about any material or object used for construction such as dirt, rocks, concrete, piles, pipes, etc. In regards to construction of a water intake structure or pipeline where a crossing or direct involvement with a surface tributary stream, impoundment, or wetland may be required, placement of the pipeline itself (regardless of construction material) and any trench backfill material within the area of jurisdiction is subject to permit requirements under 404 regulations.

The Fort Worth District Corps of Engineers, who has 404 regulatory responsibility for the Mills County area, maintains a "general permit" for most pipeline construction projects. A general permit is a pre-authorized permit for a specifically identified activity which is conducted under certain specified

conditions. General permits are issued on either a nationwide or regional basis. The purpose of general permits is to provide paperwork and time expenditure relief for permitting actions which are determined to be routine and resulting in little or no impacts to waters of the U.S.

With regard to water storage and transmission facilities for the District, crossings of surface tributaries with water lines will be necessary and, therefore, legally subject to permitting requirements under federal law. As pipeline construction activities are considered minor works with minimal impacts to waters of the U.S. by the Port Worth Corps (hence the general permit), the Corps does not spend much effort trying to enforce and specifically permit all pipeline construction projects. In fact, the majority of water and wastewater pipeline construction projects in the Central Texas area are constructed without specific notification or approval of the Corps. Even though the legal requirement for permitting exists, the Corps generally takes the position that as long as pipelines are constructed according to the conditions of the general permit (basically, return of natural contours and no permanent obstruction of watercourses); that no impacts occur to cultural resources or threatened or endangered species for which other federal regulations exist; and that no one (agency or individual) objects and complains about the activity, the activity is authorized under the general permit without formal notification and paperwork.

Under 404 regulations a general permit may be suspended for any given project and a full individual permit required if impacts to cultural resources, threatened or endangered species, or other factors of the public health and welfare are potentially to occur. An individual permit action can require from a minimum of three months to a year or longer to complete and may also involve public hearings and Environmental Impact Statement requirements. It should be noted that any of the service options which do or have a high probability of resulting in significant impacts to cultural resources or federally listed threatened or endangered species stand a high probability of not being authorized under general permit.

2.2 Archaeological/Cultural Resources

The Fox Crossing Water District is considered a political subdivision of the State under the provisions of the Texas Antiquities Code, and, therefore, must consider the effects of its actions upon possible archaeological sites. Under the code, all archaeological sites, either historic or prehistoric, and significant historic structures on lands belonging to or controlled by political subdivisions of the State are automatically considered to be State Archaeological Landmarks (SALs) and may be eligible for protection. Construction projects by the District will require a Texas Antiquities Permit and coordination with the Texas Antiquities

Committee (TAC). In practice, this often necessitates an archaeological and historical survey of previously unsurveyed areas prior to any potentially destructive action. Sites recorded during this survey must be evaluated; those which are of significant historical or scientific value will be formally designated for SAL status and measures of protection or mitigation of adverse impact negotiated between the political subdivision and the TAC.

In addition to the State role in overseeing cultural resources, through the TAC, possible Federal involvement in the protection of cultural resource sites may be invoked through application for a Section 404 or Section 10 permit from the U.S. Army Corps of Engineers (USCE) should structures or lines be located in waters of the United States such as the Colorado River. Should the USCE become involved, it may request the opinion of the State Historic Preservation Officer (SHPO) concerning the effect of the project on cultural resources. Because of the high potential for cultural resources in the general area, it is certainly possible that the SHPO would, like the TAC, require archaeological survey, site evaluation, and protection and/or mitigation measures for important sites located during the initial survey. In such cases, where both the TAC and the SHPO have jurisdiction, one will usually operate as lead agency.

Cultural resources studies may be coordinated through the Texas Water Development Board (TWDB) where TWDB funds are utilized, or coordinated directly through the TAC. Because of the potential density of sites in the study area, it is anticipated that either agency will ask for archaeological surveys of planned facilities in previously unsurveyed areas.

3.0 BASELINE DESCRIPTION

3.1 Ecology

3.1.1 Geological Elements

Mills County is located on the southern edge of the Western Cross Timbers and immediately north of the Edwards Plateau. The County is divided approximately in half by a ridge line running north to south through the County. This ridge line is also the route for U.S. Highway 183, the major roadway for the County and its largest communities of Goldthwaite and Mullin. Elevations in the northern part of this ridge rise to approximately 1800 feet msl called the Pompey Mountains and fall to around 600 feet msl along the Colorado River and Pecan Bayou to the West.

The geologic outcrop in the Mills County area exposes complex formations of the post Mississippian Periods. The primary outcrops are two groups of the Pennsylvanian Period: these are the Strawn Group and the Canyon Group. These strata form a northwestward dipping homocline with an average dip of 50 feet per mile. The interface between the Strawn and Canyon Groups forms a line generally in a north-south direction through the center of the study area. The Strawn Group, being the older and deeper of the two, outcrops on the eastern side.

Characterized by alternating beds of limestone and shale, the sediments of these two groups were deposited almost horizontally in shallow seas that were advancing and retreating. Extensive lithification produced sandstone characterized by conglomerates, mud cracks, ripple marks, cross-bedding, and fossils of organisms that lived in shallow water environments. The clastic deposits (sandstone, conglomerates and shale) resulting from the surface erosion have complex lateral and vertical changes as might be expected in nearshore deposits. The alternating strata of limestones are generally continuous units. The limestones were formed as warm, shallow sea water precipitated dissolved calcium carbonate.

In the late Pennsylvanian Period, uplift in the Llano area initiated a westward tilting of the geologic strata. Deposition continued as did the tilting, throughout Permian time. By the early Triassic Period, the area was elevated land mass and no Triassic or Jurassic deposition is known to have occurred. Erosion of Permian deposits and massive deformation occurred during the Triassic and Jurassic Periods, reversing the drainage pattern from northwesterly (into inland Paleozoic Seas), to southeasterly, in the direction of what is now the Gulf of Mexico. Thus the regional dip of Cretaceous rocks overlying the Pennsylvanian sediments is toward the southeast. The first marine deposition that occurred after

the Permian Period was in early Cretaceous time, about 135 million years later. These overlying deposits of the Cretaceous Period in the southeastern and western areas of Mills County originated in a near-shore or shallow-water environment.

3.1.2 Soils

Numerous soil types and classifications exist within the County. The attached general map shows an overview of these as mapped by the Soil Conservation Service and the U.S. Department of Agriculture. These soils groups range from the deep loamy soil of the waterways to the thin rocky soils characteristic of the uplands regions. Soil groupings are generally favorable to support the area's diverse agribusiness economy.

3.1.3 Vegetation

The Fox Crossing Water District service area is located within the Western Cross Timbers vegetational area. This rough, rocky area is highly dissected by small tributaries of the Colorado River and Brazos River. Elevations within Mills County range from about 1800 feet msl in the north-central portion of the service area to about 1200 feet msl along the Colorado River. The Western Cross Timbers is predominantly

rangeland comprised of an excellent mixture of forage plants. Important climax grasses, include switchgrasses, several bluestems, buffalograss, gramas, and Indiangrass. The Western Cross Timbers supports a brush overstory of post and blackjack oak, mesquite, and junipers. However, these brush species are generally considered "invaders" of the climax grasslands and open savannahs.

The Western Cross Timbers consist of gently rolling terrain characterized by strips of woodlands stretching along grasslands. The woodlands are generally forested by an overstory of post oak (Quercus stellata), Texas oak (Quercus texana), mesquite (Prosopis chilensis), and blackjack oak (Quercus marilandica). These four overstory species vary in community dominance throughout the study area. The understory is typically sparse within these woodlands and consists of saplings of the overstory, yaupon (Ilex vomitoria), Texas persimmon (Diospyros texana), and coma (Bumelia lanuginosa). Grasses and forbs are sparse in these woodlands due to density of the overstory canopy.

The grasslands within the study area typically occupy the nearly level to moderate slopes. Common herbaceous species include side oats grama (Bouteloua curtipendula), tall drop seed (Scorobolus asper), little bluestem (Schizachyrium scoparium), silver bluestem (Bothriochloa saccharoides),

buffalograss (Buchloe dactyloides), and panic grass (Panicum, sp.). Forb species occurring in the grasslands include upright coneflower (Ratibida columnaris), lemon beebalm (Mondarda citriodora), and Texas yucca (Yucca rupicola).

The lowland woodlands occupy the areas along the Colorado River and the Pecan Bayou, and also along mesic creek bottoms. Due to the greater moisture availability in these locales, pecans (Carya illinoienensis), cottonwood (Populus deltoides), and elm (Ulmus americana) dominate the overstory along the waterways. Other species that are common in the lowland woodlands includes the American sycamore (Platanus occidentalis), sugar hackberry (Celtis laevigata), and cedar elm. American beautyberry (Callicarpa americana), grapes (Vitis sp.), soapberry (Sapindus saponaria), and the occasional mesquite (Prosopis glandulosa) comprise the understory.

3.1.2 Wildlife

The study area is located in Mills County and lies within the Texas Rolling Plains. This province is synonymous with the Western Cross Timbers vegetational region described previously. The vertebrate fauna of the Balconian Province is represented by a mixture of species from the Kansan, Texan, Austroriparian, Chihuahuan, and Tamaulipan provinces.

The major wildlife habitats occurring within the study area are synonymous with the vegetative cover types discussed in Section 3.1.1. The woodland habitats provide cover, mast, and other food items for a diversity of wildlife. Species commonly found in the woodland habitats include the white-tailed deer (Odocoileus virginianus), fox squirrel (Sciurus niger), raccoon (Procyon lotor), eastern cottontail (Sylvilagus floridanus), tufted titmouse (Parus bicolor), and the Texas spiny lizard (Sceloporus olivaceus), among others. Dense oak/juniper woodlands of the project area also provide habitat for many bird species. The grasslands are important habitats. They provide a diversity of forage and forbs for species such as the white-tailed deer and eastern cottontail, seed for species such as the northern bobwhite (Colinus virginianus), mourning dove (Zenaida macroura), and painted bunting (Passerina ciris).

3.1.3 Aquatic Ecology

The study area lies within the Brazos River and Colorado River watersheds. The area is characterized as rolling hills that are highly dissected by mainly intermittent streams that flow only under wetter weather.

Mills County's western boundary includes approximately 50 miles frontage along the Colorado River. Common fish species

occurring in this body of water and, possibly, up the mouths of some creeks, include the bluegill (Lepomis macrochirus), carp (Cyprinus carpio), golden shiner (C. auratus), largemouth bass (Micropterus salmoides), Guadalupe bass (M. treculi), channel catfish (Ictalurus punctatus), and mosquitofish (Gambusia affinis).

The aquatic habitats within the creeks of the study area are limited due to the intermittent nature of the streams, scouring by storm events, and the solid limestone substrate. A few springs and seeps are present within the study area boundary and are shown on Figure 1 (map pocket). These are usually situated at the head of the major canyons at the start of the tributaries. The springs or seeps are usually small groundwater fields that are closely associated with surface flow. These features typically do not support any substantial sustainable aquatic habitats.

3.1.4 Threatened and Endangered Species

It was not within the scope of this study to perform detailed field work for habitat identification and mapping of threatened and endangered species. Resource review of previous studies and mapping were done through the Texas Natural Heritage Program at the Texas Parks and Wildlife Department. Because of the lack of detailed study in the

area, information is quite limited. Prior to design and construction of specific projects, the affected areas should be more closely scrutinized and alternate plans or mitigation methods determined.

Threatened or endangered vertebrate species previously mapped or possible within the study area include the Guadalupe bass (Micropterus treculi) possible in the San Saba River or Colorado River, the Texas map turtle (Graptemys versa), Black-capped Vireo (Vireo atricapillus), and the Golden-cheeked Warbler (Dendroica chrysoparia). Possible threatened or endangered plant species may include the Hill Country Wild Mercury (Argythamnia aphoroides) and the Buckley Tridens (Tridens buckleyanus).

3.1.5 Wetlands/404 Jurisdiction Areas

Waters of the U.S. as defined in Section 404 of the Clean Water Act include all streams and ponds of the study area in addition to the Colorado River and Pecan Bayou. Construction within these waters will require a Section 404 permit from the Fort Worth District Corps of Engineers.

3.2 Archaeological/Cultural Resources

3.2.1 Cultural Background

At the most general level, the prehistory of Central Texas can be divided into four general periods or stages. In current terminology, these are the Paleoindian, the Archaic, the Late Prehistoric and the Historic.

The Paleoindian stage was originally devised to encompass the earliest inhabitants of the New World, spreading across the continent in the waning years of the Pleistocene era. These cultures are known by their distinctive lithic technology, including a series of well-made lanceolate projectile points. Site types occupied during this stage include both rock shelters and open sites. The Paleoindians have been described as nomadic big-game hunters and many of the earliest sites of this period are associated with now-extinct large mammals of the Pleistocene era. The first occupations of the New World, however, may have occurred much earlier than the 11,500 B.P. date often given as the initial date for the Paleoindian period, and, outside of the Great Plains and the Rocky Mountain West, big-game hunting may not have been the most important economic pursuit during this period.

The warming climates at the end of the Pleistocene are associated with a relatively rapid cultural change. The cultures of the Archaic stage, beginning around 8,500 B.P., were originally distinguished from the earlier Paleoindian cultures by increasingly regionalized traditions with a perceived wider exploitation of available food sources. In general, it appears that the Archaic peoples began to settle into their environment, becoming increasingly familiar with the resources of the regions which they inhabited. This is a trend which must have begun during the latter part of the Paleoindian stage and continued throughout most of the Archaic. Toward the end of the Archaic period, population densities may have increased and connections may have been established between the hunter-gatherers of Central Texas and the complex cultures developing in surrounding regions. Large burial sites in some parts of south central and coastal Texas in the Late Archaic may indicate intensive reoccupation of certain sites or, possibly, increasing sedentarism of the cultural groups.

The final prehistoric period in Texas, the Late Prehistoric, is marked by the introduction of new technologies, including the bow and arrow and ceramics, as well as potentially new adaptive strategies. While the earliest part of this period, beginning about A.D. 500, may indicate introduction of new

technologies into existing cultural patterns, the latest part seems to indicate the possible actual introduction of peoples following a southward extension of the range of the bison.

Although the Historic stage theoretically begins in Texas with the arrival of Alvar Nunez Cabeza de Vaca and the survivors of the Narvaez expedition on the Texas coast in 1528, there may have been earlier landings, notably by the expeditions sent by Francisco Garay, then governor of Jamaica, to the mouth of the Rio Grande between 1519 and 1523 (Salinas 1986:34-8). In any case, the influences of European colonization were not strongly felt for several centuries. By the middle of the 18th century, however, massive depopulation and cultural disintegration was evident among native Indian groups. Although the historic settlement of Texas began in earnest during the 18th century, it was not until the Anglo settlement of the 19th century that occupations occurred outside the core of early Spanish settlement.

3.2.2 Previous Research

Only limited archaeological investigations have previously occurred in the study area. Pending funding and implementation of the project, archaeological overview of the affected areas should be further pursued with the assistance of the Texas Water Development Board staff archaeologists.

4.0 ENVIRONMENTAL EFFECTS AND CONSTRAINTS

4.1 Ecology

4.1.1 Vegetation and Wildlife

Vegetation within the study area is, for the most part, typical of the Western Cross Timbers. However, some of the area could support threatened or endangered species, as protected by the Federal Endangered Species Act of 1973.

In order to identify potential constraints, threatened and endangered species field surveys should be conducted in the areas of proposed construction. This effort should be performed in conjunction with the engineer's design and approval of the proposal project.

4.1.3 Aquatic

Construction activities within the aquatic habitats of the project areas are governed by Section 404 of the Clean Water Act as administered by the Fort Worth District Corps of Engineers. These waterways pose a potential constraint because a Federal 404 permit is required to construct within them. In order to comply with the conditions of the permit, it must be demonstrated that the project will not impact cultural resources, threatened or endangered species, or other factors affecting public health and welfare.

Archaeological/Cultural Resources

The few sites previously mapped within the study area are little indication of the difficulties which might arise when cultural resources are not taken into account during the planning process. As previously noted, less than five percent of the total service area has been subjected to complete archaeological survey. A complete archaeological survey of the County might reveal ten or twenty times this number of sites. Such a survey is not necessary, of course, but it points to the possibility that some of the proposed facility locations may coincide with the locations of significant archaeological sites.

The majority of the sites within the study area will be prehistoric. Locations vary considerably but several potential location types clearly predominate in the small sample of sites. These include sites on broad hilltops, on intermediate benches along the side slopes of larger hills, at or near the head of small drainage valleys and along the margins of the larger streams. Given the siting requirements for water facilities, the first two types are likely to cause the greatest trouble. Fortunately, many of these hilltop sites are surficial and often previously disturbed. Since most disturbed sites will not be considered worthy of formal SAL designation or NRHP status, these sites should pose little obstacle to facilities construction.

5.0 RECOMMENDED ACTION

The development of water treatment and distribution facilities within the Fox Crossing Water District service area is expected to require permits and approvals from various Federal and State agencies which may include the USCE, USFWS, TAC, and the TWDB. In order to assure the necessary permits and approvals do not unnecessarily delay the development of water supply facilities, the following actions are recommended.

5.1 Preliminary Coordination

5.2 USCE & USFWS Permitting

As previously mentioned, pipeline construction projects which involve crossing of waterways require permit authorization under Section 404 of the Clean Water Act by the U.S. Corps of Engineers. Recommendations to assure timely acquisition of a 404 permit include submitting development plans and a summary of threatened and endangered species, and significant cultural resources prior to construction. If the summary indicates the potential for threatened and endangered species and cultural resources exist, surveys may be required thus delaying the construction of facilities. Therefore, it is recommended that coordination with the USCE begin immediately upon decision to develop the planned facilities and necessary (if required) surveys conducted.

5.3

Preliminary Cultural Resources Coordination

Recommendations include maintaining contact with an archaeologist as part of the planning process. When final locations for lines and facilities are determined, an assessment of the regulatory requirements should be made and contact made with the appropriate State and/or Federal agencies. If required, a cultural resources survey of the proposed route should be initiated immediately and any significant or potentially significant sites can be dealt with, causing as little delay as possible. Since survey of small parcels of land is relatively inefficient, particularly when an Antiquities Permit must be secured for each, it is recommended that as many as possible of the proposed facilities be grouped for cultural resources survey at one time to save time and money.

It is important to note that the time involved in acquiring the previously described permits and approvals case vary significantly depending upon the sensitivity of the environment, location of facilities, and potential for intervention by special interest groups. Based on the previously described sensitive environmental features, potential habitat for threatened and endangered species and high probability of significant cultural resource sites, it is recommended preliminary coordination with the appropriate Federal and State agencies begin immediately upon decision to develop the planned facilities.

CLIMATE

The climate of Mills County is subtropical with dry winters and humid summers. Mean total precipitation is 27.40 inches annually. There is a wide annual range in temperature, and air mass changes are frequent during the cool season. Prevailing winds are south to south-southeasterly throughout the year, although northerly winds are frequent in winter.

Winter temperatures are mild with only about four days during the season, on an average, when the maximum temperature fails to rise above freezing. Rapid drops in temperature occur when polar and arctic air masses plunge southward out of Canada. Periods of very cold weather are short however, rarely lasting longer than two or three days. Periods of fair, mild weather often occur in January and February. The lowest temperature on record (since 1890) is -2°F , and occurred in January, 1940.

Hot daytime temperatures in summer are brought down by thunderstorm activity on an average of five times a month. The highest temperatures are usually associated with fair skies, southwesterly winds and dry air. The record high temperature at Brownwood Meteorological Station (since 1890) is 113°F , and occurred in July, 1925.

Thundershowers occur with greatest frequency during May and June, contributing to a peak rainfall period during late spring and early summer (see Figure II.A-6).

The anticyclonic atmospheric circulation over Texas summer results in a relatively dry period in late summer, followed by a secondary peak in rainfall in early fall. High intensity rains of short duration, producing rapid runoff, may occur any time during the year.

Snowfall in the area is almost negligible. A few exceptionally heavy snowfalls, such as the eight-inch fall in February, 1966, create a bias in the mathematical mean for long periods of years so that the mean is usually a poor estimate of expected snowfall. In January, 1919, a record fall of 17 inches occurred. Ordinarily snow remains on the ground no longer than a few hours.

The growing season (freeze free period) in Mills County averages 247 days. The average date of the last freeze in the spring is March 16, while the average date of the first freeze in the fall is November 19. Low temperatures are very sensitive to variations in topography, wind, vegetative cover, soil type and condition; therefore, significant departures from these mean values are likely to be found.

Mean annual relative humidity is about 78 percent at 6:00 a.m., 51 percent at noon, and 45 percent at 6:00 p.m., Central Standard Time. Seasonal variations are small. The area receives about 65 percent of the total possible sunshine annually. Mean annual lake evaporation is estimated at 64 inches.

Reviewing the climatological summary at Table B1 the climate is subtropical with mild winters, generally favorable for outdoor work or recreation the year round. Daytime temperatures are rather hot in summer, moderate in spring and fall.

Insert Table B-2
General Soil Map
Mills County, Texas

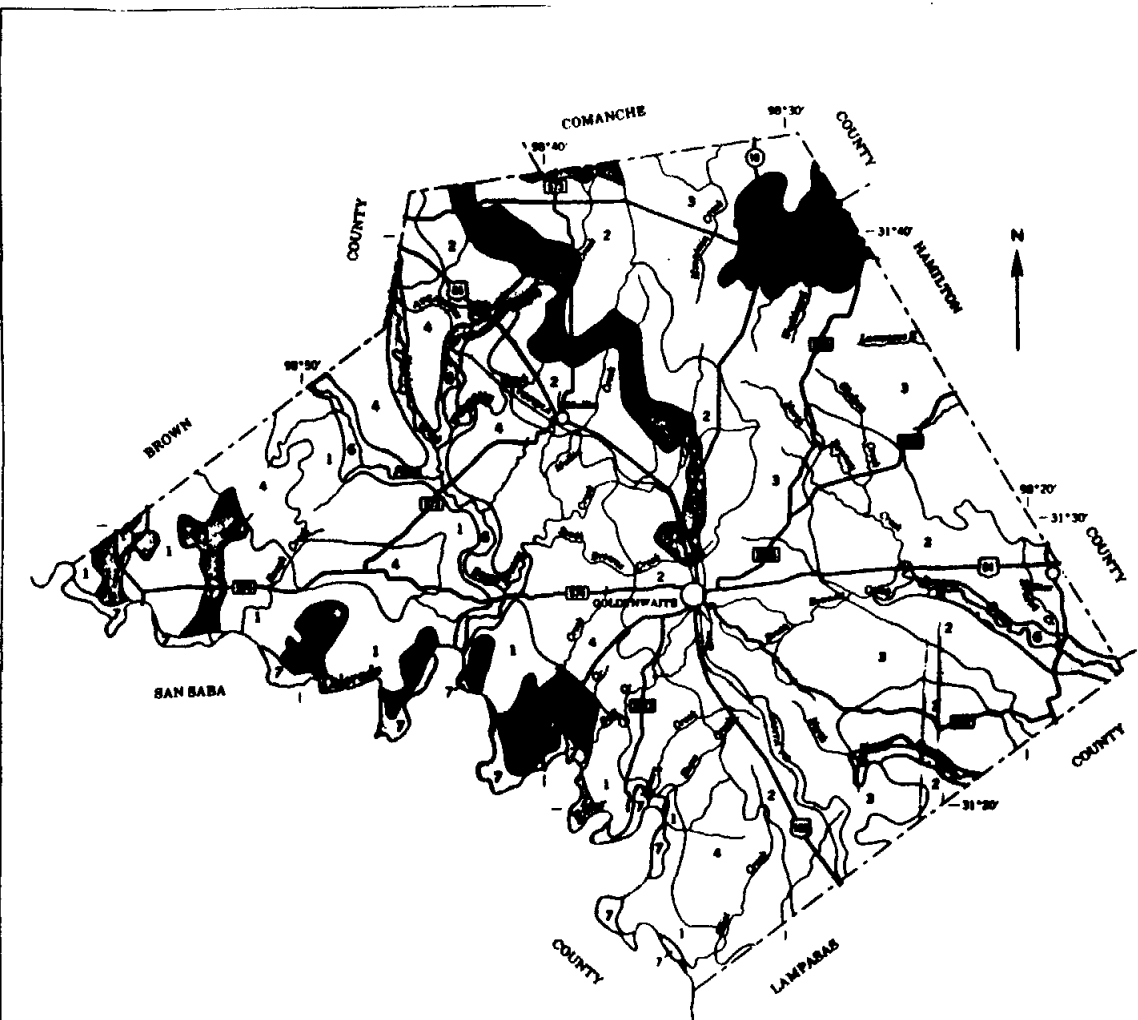

LEGEND*

(Not all soil units appear in both counties.)

VERY SHALLOW TO DEEP, LOAMY AND CLAYEY SOILS ON UPLANDS

- 1 Colahan-Throck-Bentl: Gently sloping to hilly, moderately deep to deep, stony, loamy soils over sandstone or shale
- 2 Boler-Brecht: Gently sloping to hilly, shallow to moderately deep, gravelly, loamy soils over limestone
- 3 Tarrant-Tarply: Gently sloping to hilly, very shallow to shallow, cobbly and stony, clayey and loamy soils over limestone
- 4 Double-Peel: Gently sloping to hilly, shallow to moderately deep, gravelly and cobbly, loamy soils over limestone and loamy sediment
- 5 Speck-Tarrant: Gently sloping, shallow to very shallow, stony, loamy and clayey soils over limestone

DEEP, LOAMY AND CLAYEY SOILS ON FLOOD PLAINS AND UPLANDS

- 6 Frie-Sunco-Winters: Nearly level to gently sloping, deep, loamy soils over loamy and clayey alluvium
- 7 Westwood-Claremont: Nearly level, deep, loamy soils over loamy alluvium

MODERATELY DEEP AND DEEP, LOAMY AND CLAYEY SOILS ON UPLANDS

- 8 Pedernales-Millard-Hest: Gently sloping to sloping, moderately deep to deep, loamy soils over loamy sediment
- 9 Leary-Sagerton-Nukrum: Nearly level to gently sloping, deep, loamy and clayey soils over clayey or loamy sediment
- 10 Krum-Boler-Denton: Gently sloping, moderately deep to deep, clayey and loamy soils over limestone or clayey sediment
- 11 Bastrop-Winters-Sagerton: Nearly level to gently sloping, deep, loamy soils over loamy sediment

DEEP, SANDY AND LOAMY SOILS ON UPLANDS

- 12 Pedernales-Millard-Chaney: Nearly level to gently sloping, deep, sandy and loamy soils over loamy sediment or soft sandstone

*Terms for texture refer to the surface layer of the major soils in each map unit.

Compiled 1979

Each area outlined on this map consists of more than one kind of soil. This map is that meant for general planning rather than a basis for decisions on the use of specific soils.

U. S. DEPARTMENT OF AGRICULTURE
SOIL CONSERVATION SERVICE
TEXAS AGRICULTURAL EXPERIMENT STATION

GENERAL SOIL MAP MILLS COUNTY, TEXAS

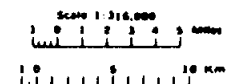

Insert Table B-3
Typical Weather Conditions

FIGURE B-3
TYPICAL WEATHER CONDITIONS

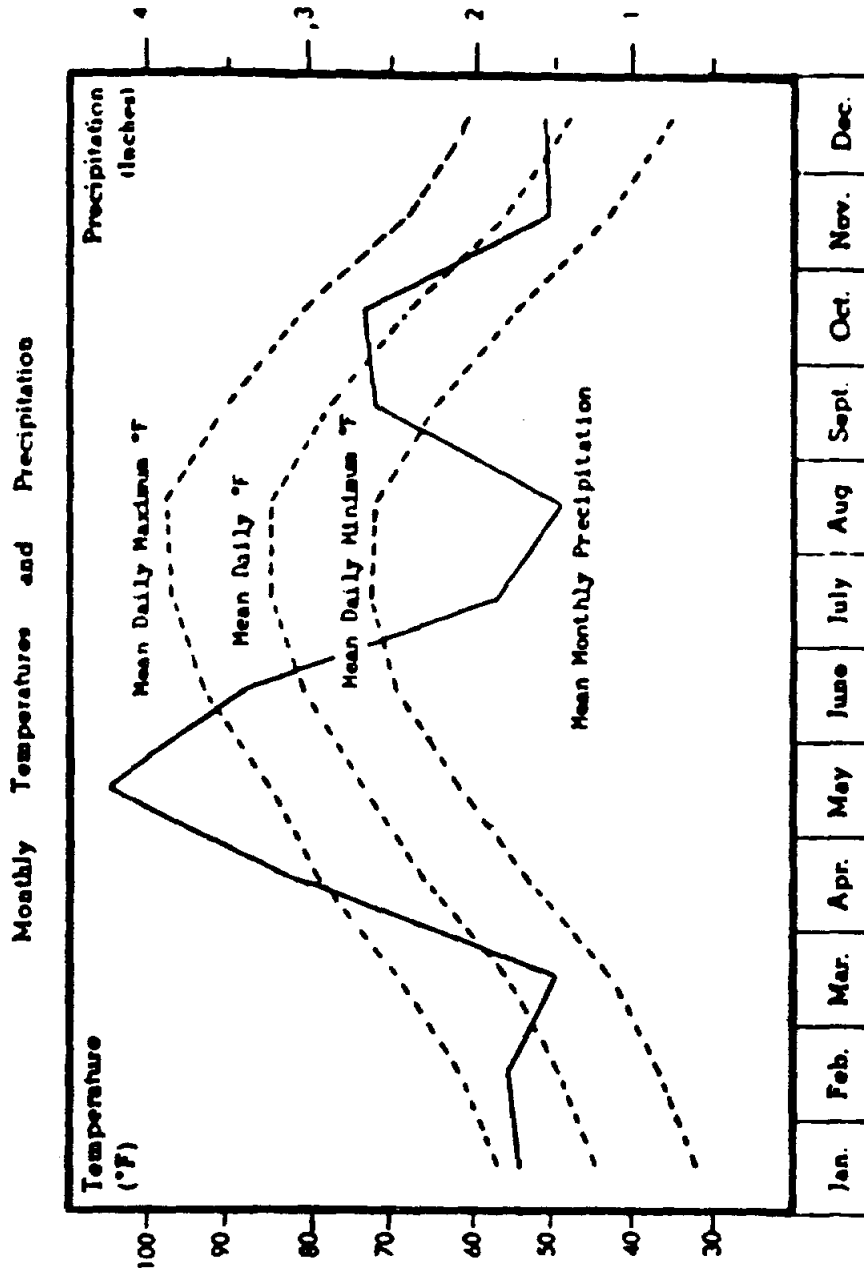

APPENDIX C
Settlement Agreement

RECEIVED

FEB 26 1985

TEXAS DEPT. OF WATER RESOURCES
AUSTIN, TEXAS

STATE OF TEXAS I

COUNTY OF TRAVIS I

SETTLEMENT AGREEMENT

This settlement agreement ("the Settlement Agreement") by and between the Lower Colorado River Authority ("LCRA") and the Colorado River Municipal Water District ("CRMWD") hereinafter sometimes collectively referred to as ("Parties"), WITNESSETH:

WHEREAS, CRMWD and LCRA have for several years been engaged in several controversies revolving around CRMWD's proposed Stacy dam and reservoir and LCRA's water rights; and

WHEREAS, LCRA and CRMWD now wish to settle their differences in a way that allows CRMWD the opportunity to build Stacy dam and to operate the reservoir to meet the needs of its municipal customers, while preserving LCRA's water rights, including the right to store water in Highland Lakes, to the maximum extent possible consistent with the construction and operation of Stacy dam;

NOW, THEREFORE, LCRA and CRMWD agree to settle their differences on the terms and for the consideration set forth below.

Section I: Water Rights and Applications for Permits

1. The LCRA hereby contracts, effective on the date of this Settlement Agreement and continuing during the entire useful life of Stacy reservoir, with CRMWD to allow CRMWD to divert, from waters which would otherwise flow into Lake Buchanan to be stored therein and used by LCRA pursuant to its water appropriation Permit 1259, not to exceed 113,000 acre feet per annum of the waters of the Colorado River at a diversion point and diversion rate as follows:

a. Municipal Use Point of Diversion: By means of stationary pumps to be located at a point on the reservoir N 80° 50' W, 4,920 feet from the northeast corner of M. Sander Survey No. 200, Abstract No. A-749, Concho County, Texas.

b. Maximum Diversion Rate: 160.4 cfs (72,000 gpm) for municipal use and 40 cfs (17,953 gpm) for industrial use.

2. In order to obtain the permits necessary to effectuate this Settlement Agreement, CRMWD and LCRA agree to take the following steps:

a. Upon remand of its pending application for an appropriation permit, CRMWD shall amend its application to remove therefrom its request for a permit to divert water from the Colorado River. Instead, LCRA shall provide

CRMWD with sufficient water not to exceed 113,000 acre-feet of water annually appropriated by and diverted under LCRA Permit No. 1259 (Buchanan reservoir) to accommodate the Stacy dam and reservoir project on the Colorado River in Coleman, Concho and Runnels Counties, Texas. In all other respects, the permit applied for by CRMWD shall remain the same; that is, CRMWD will seek a permit to construct Stacy dam and reservoir and to store therein up to 554,340 acre-feet of water, all as previously set forth in the permit previously issued to CRMWD. LCRA will agree and amend from time to time this agreement to authorize additional diversion points as required to meet future conditions.

b. Pursuant to the Rules of the Texas Water Development Board, Texas Administrative Code §§ 303.111 - 303.120, and based upon this Settlement Agreement, LCRA will apply for a contractual amendment to its Permit 1259 to allow CRMWD to divert, at a point or points at the Stacy reservoir site to be designated by CRMWD, up to 113,000 acre-feet of water per year for municipal purposes, except that up to 25,000 acre-feet per year, may be diverted by CRMWD for industrial purposes. LCRA agrees in the future not to oppose any application filed by CRMWD with the Texas Department of Water Resources which has as its purpose converting not

to exceed 15,000 acre-feet per annum of the above-described 25,000 acre-feet of industrial use water to municipal use for the use and benefit of the City of Abilene, Texas, by and through the West Central Texas Municipal Water District.

c. CRMWD and LCRA shall jointly move the Texas Water Commission to consolidate for hearings and decision the two applications described above, and CRMWD and LCRA shall each join in supporting the other's application and urge its adoption.

Section II: Releases from Stacy Reservoir

1. In order to provide for the water needs throughout the Colorado River basin and to protect LCRA's water rights, including the right to store water in the Highland Lakes, to the maximum extent possible consistent with the construction and operation of Stacy dam, CRMWD agrees to release water from Stacy reservoir upon the call of LCRA in accordance with the following terms.

a. Release Provision No: 1. When the surface elevation of Stacy reservoir stands between 1530.5 and 1543 feet above mean sea level and Buchanan and Travis reservoirs shall have reached sixty-five percent (65%) (1,400,000

acre-feet) or less, as calculated by LCRA from its existing official area-capacity curves for said reservoirs, LCRA shall be entitled to call for a release of water equal to 50% of the net volume of water impounded in Stacy subsequent to the last LCRA spill or release whichever is the later to occur; but the right of release under this Section II.1.a. shall not require the release of water so as to reduce the level of Stacy reservoir below the higher of (i) the level of storage necessary to meet the demonstrated demand on Stacy or (ii) 1530.5 feet elevation.

b. Release Provision No. 2. In addition to LCRA's rights under Release Provision No. 1, LCRA should be entitled to call for a release of all water impounded in Stacy reservoir above 1543 feet above mean sea level when LCRA has combined empty storage space in Buchanan reservoir below elevation 1018 mean sea level and in Travis reservoir below elevation 678 mean sea level, to impound the amount of water to be released. Provided, however, that the triggering elevation of this Release Provision No. 2 (1543 feet) should be adjusted upward when a greater level of storage is necessary to meet the demonstrated municipal demand on Stacy.

2. CRMWD and LCRA agree that LCRA may exercise its right to call for releases under Release Provisions Nos. 1 and 2 whenever the conditions are met, without regard to the length of time elapsed since the last LCRA spill or release whichever is the later to occur or the number of times LCRA has exercised its right to call for releases since the last LCRA spill or release whichever is the later to occur.

3. The following definitions and rules of calculation apply to Section II of this Agreement.

a. An LCRA spill occurs whenever (i) the water level of Lake Buchanan reaches 1020 feet above mean sea level or the water level of Lake Travis reaches 681 feet above mean sea level (ii) LCRA has begun releasing water at that dam, either through the hydroelectric turbines or through the flood gates.

b. The demonstrated demand is one-third (1/3) rounded to the nearest 1,000 of the diversions of water in acre-feet from Stacy reservoir for CRMWD's water-supply customers during the preceding three (3) calendar years, as stated in the annual report sworn and filed with the Texas Department of Water Resources or its successors on or before January 31 of each year. To this end, (i) CRMWD will operate its system so as to take as much of its water

requirements from the J. B. Thomas reservoir (constructed pursuant to Permit No. 1394) and the Spence reservoir (constructed pursuant to Permit No. 2179) as is feasible and consistent with reasonable operating requirements and shall take not less than 20,000 acre-feet of the water required to supply its uses during each year from the J. B. Thomas reservoir, provided that the total storage in such reservoir is not less than 100,000 acre-feet at anytime during such year; and (ii) CRMWD will route through the Stacy reservoir without detention all water required to be released from the Spence reservoir pursuant to Permit No. 2179.

c. The level of storage necessary to meet the demonstrated demand on Stacy reservoir shall be determined by reference to the table comparing storage level to "Adopted Yield", for this purpose only, attached to this Settlement Agreement as Exhibit "A". and which shall be contained in operations manual ("Operations Manual") referred to in Section III.3. and incorporated herein by reference.

d. Net water impounded being defined as the amount of impounded water, including return flows, less inadvertent losses such as evaporation, seepage and transpiration, but excluding (i) diversions by pumpage from Stacy reservoir

above elevation 1,530.5 mean sea level and below elevation 1,543.0 mean sea level subsequent to the last spill or release whichever is the later to occur and (ii) releases from Stacy which may be required by or for the benefit of the Parks and Wildlife Commission of the State of Texas or any other agency of the State or Federal Government for environmental purposes which exceed both 5,000 acre feet per annum and 5,000 acre feet since the last LCRA spill.

3. Unless otherwise agreed by both parties, all releases under this Section shall be made at the rate of 5,000 cubic feet per second.

Section III: General Agreements

1. LCRA and CRMWD will operate their respective reservoirs in a coordinated manner in order to enhance the ability of both parties to impound the maximum amount of water available for beneficial use within their respective water-service areas. CRMWD agrees to operate Stacy dam and reservoir in a reasonable and prudent manner in connection with CRMWD's other sources of water supply so as to conserve water and prevent waste. CRMWD agrees that it will operate the Stacy dam and reservoir project in accordance with this Settlement Agreement and in accordance with any permit issued to CRMWD to build and operate the Stacy dam and reservoir project. CRMWD agrees to use all water available to it from Stacy reservoir for

municipal, industrial and dam construction purposes only and to never use or sell or permit to be sold any water from Stacy reservoir for secondary recovery purposes or for filling Spence reservoir. Neither Party hereto shall manipulate by contract or otherwise, its use, disposition or pattern of use of water from any of its reservoirs, or other sources of water supply, in such a manner as to adversely effect the terms of this Agreement.

2. It is the intent of the Parties hereto to cooperate and to coordinate their future water supply and related development activities in order to provide for the maximum conservation of state water from all uses within the Colorado River basin and with due regard to the environmental well-being of the basin. Parties shall provide each other such reports, records and documents as Parties may reasonably request from time to time for the purpose of monitoring the circumstances and events relative to LCRA's release rights and for the purpose of enforcing such rights. The required reports, records and documents shall be delivered in accordance with the notice provisions set forth below. In addition, both Parties shall be entitled to inspect the records and facilities of the other for the purpose of monitoring and assuring compliance with the terms of such release provision.

3. CRMWD agrees, as an aid in administrating state water of the Colorado River and the provisions of this Settlement Agreement and any permit issued to CRMWD to construct Stacy dam and

reservoir and, prior to the date of deliberate impoundment of water in Stacy reservoir, to prepare in cooperation with and with the approval of LCRA, the Operations Manual describing the methods and procedures to be used by CRMWD to accomplish the provisions of this Settlement Agreement and any other special conditions which may be contained in the Stacy permit.

Section IV: Additional Provisions

1. The effectiveness of this Agreement shall be conditioned upon:

a. The approval of this Agreement by the Texas Water Commission;

b. Issuance of a permit by the Texas Water Commission which authorizes construction of Stacy dam and reservoir substantially in accordance with the applicable and appropriate provisions of this Settlement Agreement.

c. Compliance of LCRA with the requirements of Texas Administrative Code §§ 303.111 - 303.120 and approval by the Texas Water Commission of a contractual amendment to LCRA Permit No. 1259 accommodating the terms of this Agreement.

2. In consideration of the right to divert granted by the terms of this Agreement, CRMWD agrees:

a. To dismiss with prejudice its opposition to the adjudication of LCRA's water rights in the amounts claimed for such rights by LCRA in the currently pending adjudication of the Middle and Lower Colorado River segments of the Colorado River; and

b. Not to support, directly or indirectly, any challenge to the water permits of LCRA or to LCRA's statutory organization or authority by any action to be taken before any administrative agency of the State of Texas or by or before the Legislature of the State of Texas; provided CRMWD's obligation under Section IV 2.b. is conditioned upon the obligation of LCRA not to introduce, directly or indirectly, any legislation relating to the organization or authority of CRMWD without the consent of CRMWD.

3. This Settlement Agreement shall be null and void if CRMWD has not completed construction of the Stacy dam and reservoir project within ten (10) years after the date of this Settlement Agreement; provided, however, if construction of the Stacy dam and reservoir project is required to be delayed by order of a court of competent jurisdiction or any governmental agency having jurisdiction over

CRMWD the period of such delay shall be added to the time within which CRMWD is required to complete construction of the project hereunder.

4. All notices and other documents required or permitted to be given pursuant to this Agreement shall be made by delivery to the party to whom sent at the following addresses:

For Lower Colorado River Authority, to
3700 Lake Austin Boulevard
Austin, Texas 78703

For Colorado River Municipal Water District, to
400 East 24th Street
Big Spring, Texas 79720

IN WITNESS WHEREOF, the parties, acting under authority of their respective governing bodies, have caused this Settlement Agreement to be duly executed in several counterparts, each of which shall constitute an original, all as of the day and year below written, which is the date of this Settlement Agreement.

LOWER COLORADO RIVER AUTHORITY

DATE: February 22, 1985

By: *Ed N. Salerberg*
GENERAL MANAGER

ATTEST:

Don E. Bagley Jr.
ASSISTANT SECRETARY

COLORADO RIVER MUNICIPAL WATER DISTRICT

DATE: February 26, 1985

By: *[Signature]*
PRESIDENT, BOARD OF DIRECTORS

ATTEST:

[Signature]
SECRETARY, BOARD OF DIRECTORS

EXHIBIT "A"
STACY RESERVOIR

<u>MSL ELEVATION</u>	<u>STORAGE IN ACRE-FEET</u>	<u>ADOPTED YIELD IN ACRE-FEET</u>
1551.50	554,340	90,700
1548.50	498,728	87,000
1548.00	489,772	85,000
1545.50	446,903	80,000
1545.00	438,584	75,000
1543.00	406,579	67,000
1542.00	391,198	61,000
1539.00	347,446	59,000
1536.00	307,188	55,000
1533.00	270,326	54,000
1530.50	242,186	53,000

APPENDIX D

Colorado River Main Stem
Water Discharge Records and
Water Quality Records

COLORADO RIVER GAGE STATION

08147000 COLORADO RIVER NEAR SAN SABA, TX
(National stream-quality accounting network)

LOCATION.--Lat 31°13'04", long 98°33'51", San Saba-Lampasas County line, Hydrologic Unit 12000201, near left bank at downstream side of pier of bridge on U.S. Highway 190, 9.2 mi downstream from San Saba River, 9.2 mi east of San Saba, and at mile 474.3.

DRAINAGE AREA.--31,217 mi², approximately, of which 11,398 mi² probably is noncontributing.

WATER-DISCHARGE RECORDS

PERIOD OF RECORD.--October 1915 to October 1922 (published as "near Chadwick"), October 1923 to August 1930 (published as "near Tow"), September 1930 to current year. Monthly discharge only for some periods, published in MSP 1312.

REVISED RECORDS.--MSP 458: 1916. MSP 858: 1900(M), 1936(M). MDR TX-81-3: Drainage area. MSP 1512: 1916-18(M), 1936. MSP 1732: 1925-26(M).

GAGE.--Water-stage recorder. Datum of gage is 1,096.22 ft above National Geodetic Vertical Datum of 1929. See MSP 1922 for brief history of changes prior to May 23, 1940.

REMARKS.--No estimated daily discharges. Records good. There are many diversions above station for irrigation, municipal use, and for oil field operation. Flow is affected by four reservoirs upstream from Winchell and one reservoir in the San Saba River and Pecan Bayou basins; combined capacity, 1,973,000 acre-ft. Flow is affected at times by discharge from the flood-detention pools of 167 floodwater-retarding structures with a combined capacity of 205,700 acre-ft. These structures control runoff from 944 mi². Gage-height telemeter at station.

AVERAGE DISCHARGE.--50 years (water years 1917-19, 1921-22, 1924-68) prior to completion of Robert Lee Dam, 1,340 ft³/s (970,100 acre-ft/yr); 20 years (water years 1968-88) partially regulated, 649 ft³/s (470,200 acre-ft/yr).

EXTREMES FOR PERIOD OF RECORD.--Maximum discharge, 224,000 ft³/s July 23, 1938 (gage height, 63.2 ft, present site), based on floodmarks at site then in use; no flow Aug. 27-31, 1954; Aug. 3-13, 1963; July 20 to Aug. 8, Aug. 11-14, 1964.

EXTREMES OUTSIDE PERIOD OF RECORD.--Maximum stage during period 1878 to July 22, 1938, 58.4 ft Sept. 25, 1900 (discharge, 184,000 ft³/s, present site), from floodmarks at former site.

EXTREMES FOR CURRENT YEAR.--Maximum discharge, 11,000 ft³/s June 2 at 2030 hours (gage height, 12.10 ft); minimum daily, 37 ft³/s June 25.

**DISCHARGE, CUBIC FEET PER SECOND, WATER YEAR OCTOBER 1967 TO SEPTEMBER 1968
MEAN VALUES**

DAY	OCT	NOV	DEC	JAN	FEB	MAR	APR	MAY	JUN	JUL	AUG	SEP
1	486	280	266	348	238	242	163	114	168	131	582	512
2	402	274	266	320	231	242	161	110	9060	511	578	481
3	374	263	266	309	226	242	151	99	7080	387	572	382
4	355	258	266	300	223	243	142	86	3880	290	563	233
5	353	253	264	287	220	247	137	78	2540	228	555	172
6	344	251	261	281	221	242	129	77	1830	167	559	134
7	323	248	261	277	221	242	126	73	1560	131	572	108
8	304	246	261	273	224	238	128	67	1230	143	560	89
9	290	229	261	268	228	234	124	58	988	510	535	77
10	279	268	261	266	231	229	115	51	784	611	543	73
11	272	265	258	258	233	229	115	56	646	712	553	70
12	263	228	256	261	233	225	122	70	423	3630	538	67
13	257	301	256	259	237	215	114	1190	281	1570	536	68
14	254	275	253	256	237	203	105	1080	202	993	537	67
15	255	266	251	256	237	195	105	763	156	714	555	66
16	256	274	247	261	237	188	103	503	131	523	535	58
17	253	247	244	257	237	186	102	356	113	381	524	57
18	254	374	242	256	246	183	99	326	103	298	511	58
19	262	335	253	252	264	182	101	294	82	234	512	63
20	283	310	283	248	271	180	100	247	85	422	518	68
21	526	299	306	242	265	183	116	225	77	600	518	68
22	487	316	363	238	262	187	125	186	68	587	518	62
23	407	323	367	253	261	187	118	165	48	628	506	167
24	373	317	341	286	252	185	127	153	38	607	514	255
25	382	287	448	283	244	186	178	142	37	583	543	283
26	382	283	383	271	243	186	178	127	388	584	747	188
27	334	276	342	288	244	183	188	191	68	572	628	188
28	314	271	388	248	242	178	137	181	68	546	523	187
29	298	271	311	243	242	174	122	153	85	588	603	88
30	293	287	388	244	---	166	116	127	82	561	487	188
31	287	---	386	244	---	163	---	118	---	571	486	---
TOTAL	10162	8863	9247	8292	8950	6388	3827	7466	32018	18884	18808	4852
MEAN	328	286	298	267	248	206	128	241	1067	613	545	162
MAX	526	374	541	348	271	247	178	1190	9088	3638	747	512
MIN	253	246	242	233	220	163	68	51	37	131	486	57
AC-FT	20160	17580	18340	16450	13790	12630	7580	14810	63510	37678	33540	8438

CAL YR 1967 TOTAL 447668 MEAN 1226 MAX 16800 MIN 242 AC-FT 887900
WTR YR 1968 TOTAL 133345 MEAN 364 MAX 9060 MIN 37 AC-FT 264500

00147000 COLORADO RIVER NEAR SAN SABA, TX--Continued
(National stream-quality accounting network)

WATER-QUALITY RECORDS

PERIOD OF RECORD.--Chemical analyses: August 1941, September 1947 to current year. Chemical and biochemical analyses: January 1968 to current year. Pesticide analyses: January 1968 to April 1982. Sediment analyses: May 1961 to October 1962, October 1977 to current year.

PERIOD OF DAILY RECORD.--

SPECIFIC CONDUCTANCE: September 1947 to current year.
WATER TEMPERATURE: September 1947 to current year.
SUSPENDED SEDIMENT DISCHARGE: December 1950 to September 1962.

REMARKS.--Mean monthly and annual concentrations and loads for selected chemical constituents have been computed using the daily (or continuous) records of specific conductance and regression relationships between each chemical constituent and specific conductance. Regression equations developed for this station may be obtained from the Geological Survey District office upon request.

EXTREMES FOR PERIOD OF DAILY RECORD.--

SPECIFIC CONDUCTANCE: Maximum daily, 8,120 microsiemens Aug. 16, 1988, minimum daily, 150 microsiemens Sept. 14, 1981, and Jan. 1, 1985.
WATER TEMPERATURE: Maximum daily, 37.0°C Aug. 3, 1956; minimum daily, 0.0°C Jan. 29, 1948, Jan. 30, 1951.

EXTREMES FOR CURRENT YEAR.--

SPECIFIC CONDUCTANCE: Maximum daily, 8,120 microsiemens Aug. 16; minimum daily, 326 microsiemens June 2.
WATER TEMPERATURE: Maximum daily, 33.0°C July 19, Aug. 8, 9, 19; minimum daily, 8.0°C Jan. 7, 9.

WATER QUALITY DATA, WATER YEAR OCTOBER 1987 TO SEPTEMBER 1988

DATE	TIME	STREAM-FLOW, INSTANTANEOUS (CFS)	SPECIFIC CONDUCTANCE (US/CM)	PH (STANDARD UNITS)	TEMPERATURE WATER (DEG C)	TURBIDITY (FTU)	OXYGEN, DISSOLVED (MG/L)	OXYGEN, DISSOLVED (PERCENT SATURATION)	OXYGEN DEMAND, BIOCHEMICAL, 5 DAY (MG/L)	COLIFORM, FECAL, 0.7 MH-F (COLS./100 ML)	STREPTOCOCCI, FECAL, IF ABAR (COLS. PER 100 ML)
NOV 19...	1440	334	1580	8.20	13.0	20	11.1	108	3.5	70	120
JAN 21...	1425	261	1800	8.30	8.0	26	10.1	88	2.0	128	120
MAR 24...	1105	160	1580	8.30	19.0	28	9.8	111	2.6	138	42
MAY 12...	1200	88	915	8.20	23.0	31	11.2	135	2.0	31	117
JUL 13...	1325	1440	1020	8.20	27.0	310	6.2	81	2.4	3800	2400
AUG 04...	1230	561	4640	8.20	29.0	9.7	7.8	104	1.7	54	72

DATE	HARDNESS TOTAL (MG/L AS CaCO3)	NONHEAVY METALS (MG/L AS CaCO3)	CALCIUM DISSOLVED (MG/L AS Ca)	MAGNESIUM DISSOLVED (MG/L AS Mg)	SODIUM DISSOLVED (MG/L AS Na)	SODIUM ADSORPTION RATIO	POTASSIUM DISSOLVED (MG/L AS K)	ALKALINITY (MG/L AS CaCO3)	SULFATE DISSOLVED (MG/L AS SO4)	CHLORIDE DISSOLVED (MG/L AS Cl)	FLUORIDE DISSOLVED (MG/L AS F)
NOV 19...	520	330	120	54	130	3	5.1	190	240	270	0.40
JAN 21...	570	350	130	58	150	3	5.0	221	280	280	0.40
MAR 24...	510	310	110	56	140	3	4.3	200	240	260	0.40
MAY 12...	330	120	66	41	66	2	3.0	212	97	130	0.30
JUL 13...	240	130	55	24	100	3	6.7	104	130	170	0.30
AUG 04...	910	760	150	130	640	9	21	149	860	930	0.40

DATE	SILICA, DISSOLVED (MG/L AS SiO2)	SOLIDS, RESIDUE AT 100 DEG. C (MG/L)	SOLIDS, SUM OF CONSTITUENTS, DISSOLVED (MG/L)	NITROGEN, NITRATE TOTAL (MG/L AS N)	NITROGEN, NITRATE DISSOLVED (MG/L AS N)	NITROGEN, NITRITE TOTAL (MG/L AS N)	NITROGEN, NITRITE DISSOLVED (MG/L AS N)	NITROGEN, NH4+NO3 TOTAL (MG/L AS N)	NITROGEN, NH4+NO3 DISSOLVED (MG/L AS N)	NITROGEN, AMMONIA TOTAL (MG/L AS N)
NOV 19...	11	962	956	2.38	--	0.020	<0.010	2.40	2.38	0.020
JAN 21...	8.3	1080	1060	3.48	3.48	0.020	0.020	3.50	3.50	<0.010
MAR 24...	5.7	1000	950	3.38	3.19	0.020	0.010	3.40	3.38	0.040
MAY 12...	10	985	942	--	--	<0.010	<0.010	0.200	0.188	0.050
JUL 13...	8.0	592	588	0.380	0.470	0.020	0.020	0.400	0.480	0.140
AUG 04...	6.2	3050	2830	--	--	<0.010	<0.010	<0.100	<0.100	0.070

COLUMBIAN RIVER NAME STUDY
00147000 COLUMBIAN RIVER NEAR DAN SADA, TN--Cont (cont)
(Not long) stream-quality accounting network)

WATER QUALITY DATA, WATER YEAR OCTOBER 1987 TO SEPTEMBER 1988

DATE	NITRO-GEN, AMMONIA DIS-SOLVED (MG/L AS N)	NITRO-GEN ORGANIC TOTAL (MG/L AS N)	NITRO-GEN, AMMONIA + ORGANIC TOTAL (MG/L AS N)	PHOS-PHORUS TOTAL (MG/L AS P)	PHOS-PHORUS DIS-SOLVED (MG/L AS P)	PHOS-PHORUS ORTHO, DIS-SOLVED (MG/L AS P)	PHOS-PHORUS ORTHO, DIS-SOLVED (MG/L AS PO4)	SEDI-MENT, SUS-PENDED (MG/L)	SEDI-MENT, DIS-CHARGE, SUS-PENDED (T/DAY)	SED. SUSP. SIEVE DIAM. % FINER THAN .062 MM
NOV 19...	0.020	0.08	0.90	0.020	<0.010	<0.010	--	60	54	84
JAN 21...	0.010	--	0.60	0.040	0.020	<0.010	--	58	41	74
MAR 24...	0.030	0.86	0.90	0.060	<0.010	<0.010	--	76	33	92
MAY 12...	0.080	0.55	0.60	0.020	0.010	<0.010	--	72	13	83
JUL 13...	0.090	0.16	0.30	0.370	0.100	0.080	0.18	879	3420	99
AUG 04...	0.050	0.73	0.80	<0.010	<0.010	<0.010	--	48	74	99

DATE	ALUM-INUM, DIS-SOLVED (UG/L AS AL)	ARSENIC DIS-SOLVED (UG/L AS AS)	BARIUM, DIS-SOLVED (UG/L AS BA)	BERYL-LIUM, DIS-SOLVED (UG/L AS BE)	CAECIUM DIS-SOLVED (UG/L AS CD)	CHRO-MIUM, DIS-SOLVED (UG/L AS CR)	COBALT, DIS-SOLVED (UG/L AS CO)	COPPER, DIS-SOLVED (UG/L AS CU)	IRON, DIS-SOLVED (UG/L AS FE)	LEAD, DIS-SOLVED (UG/L AS PB)
NOV 19...	<10	1	140	<0.5	<1	<1	<3	2	<3	<5
JAN 21...	<10	1	97	<0.5	<1	1	<3	1	4	<5
MAR 24...	--	--	--	--	--	--	--	--	--	--
MAY 12...	<10	1	96	<0.5	<1	<1	<3	4	<3	<6
JUL 13...	--	--	--	--	--	--	--	--	--	--
AUG 04...	<10	2	230	0.6	1	1	2	1	22	<5

DATE	LITHIUM DIS-SOLVED (UG/L AS LI)	MANGA-NESE, DIS-SOLVED (UG/L AS MN)	MERCURY DIS-SOLVED (UG/L AS HB)	NIOBY-DEMIUM, DIS-SOLVED (UG/L AS NB)	NICKEL, DIS-SOLVED (UG/L AS NI)	SELE-NIUM, DIS-SOLVED (UG/L AS SE)	SILVER, DIS-SOLVED (UG/L AS AG)	STRON-TIUM, DIS-SOLVED (UG/L AS SR)	YTRA-BIUM, DIS-SOLVED (UG/L AS Y)	ZINC, DIS-SOLVED (UG/L AS ZN)
NOV 19...	42	1	0.2	<10	4	1	<1.0	1900	<6	4
JAN 21...	43	2	<0.1	<10	2	2	<1.0	2200	<6	<3
MAR 24...	--	--	--	--	--	--	--	--	--	--
MAY 12...	26	6	<0.1	<10	3	1	<1.0	840	<6	<3
JUL 13...	--	--	--	--	--	--	--	--	--	--
AUG 04...	100	4	0.3	17	2	1	<1.0	2600	35	16

MONTHLY AND ANNUAL MEANS AND LOADS FOR OCTOBER 1987 TO SEPTEMBER 1988

MONTH YEAR	DISCHARGE (CFS-DAYS)	SPECIFIC CONDUCT-ANCE (MICRO-SIEMENS)	DIS-SOLVED SOLIDS (MG/L)	DIS-SOLVED SOLIDS (TONS)	DIS-SOLVED CHLORIDE (MG/L)	DIS-SOLVED CHLORIDE (TONS)	DIS-SOLVED SULFATE (MG/L)	DIS-SOLVED SULFATE (TONS)	HARDNESS (CA, MG) (MG/L)
OCT. 1987	10162	1270	733	28380	200	8480	180	4080	408
NOV. 1987	8863	1380	788	18980	220	9210	170	3880	420
DEC. 1987	9847	1790	1088	26280	310	7840	240	6030	520
JAN. 1988	8292	1780	1030	23880	300	6880	230	5250	510
FEB. 1988	8950	1980	984	17880	250	4780	200	3880	470
MAR. 1988	6366	1580	921	15080	260	4480	200	3470	480
APR. 1988	3827	1420	825	8520	230	2360	170	1800	440
MAY 1988	7466	1570	824	18600	270	5490	220	4360	450
JUNE 1988	32018	448	252	21700	59	5130	40	3430	160
JULY 1988	18994	2080	1260	64500	420	21600	360	18400	480
AUG. 1988	16908	6160	4130	189000	1900	85400	1800	83100	240
SEPT 1988	4252	3910	2440	28100	910	10500	820	9420	670
TOTAL	133345	--	--	451000	--	165000	--	147000	--
MTD.AVG.	364	2020	1250	--	460	--	410	--	370

00147000 COLORADO RIVER NEAR SAN SABA, TX--Continued
(National stream-quality accounting network)

SPECIFIC CONDUCTANCE, MICROSIEMENS PER CENTIMETER AT 25 DEG. C. WATER YEAR OCTOBER 1987 TO SEPTEMBER 1988
EQUIVALENT MEAN

DAY	OCT	NOV	DEC	JAN	FEB	MAR	APR	MAY	JUN	JUL	AUG	SEP
1	1290	911	1740	1900	1450	1500	1680	1560	780	780	5000	4250
2	1300	736	1590	1830	1540	1540	1520	1520	326	900	4690	4490
3	1200	824	1610	1810	1520	1540	1450	1400	456	970	4570	4250
4	1180	1090	1640	1770	1450	1560	1330	1270	456	1060	4790	4150
5	1220	1140	1640	1770	1470	1540	1430	1320	544	1350	5840	4220
6	1260	1130	1630	1750	1560	1530	1390	1220	575	1610	6750	4190
7	1290	1180	1630	1760	1480	1570	1390	1280	512	1660	7240	4160
8	1290	1250	1640	1740	1530	1580	1440	1260	513	1620	7320	4090
9	1320	1500	1660	1790	1540	1560	1360	1220	491	2500	7090	4000
10	1320	1430	1690	1810	1480	1530	1420	1010	485	2520	6730	3740
11	1300	1320	1700	1810	1520	1570	1340	908	486	2860	6380	3740
12	1260	1220	1710	1810	1530	1540	1330	1130	483	1360	6070	3780
13	1180	1260	1710	1790	1570	1640	1340	1820	490	910	6190	3610
14	1150	1240	1740	1750	1580	1620	1360	2570	506	760	6400	3630
15	1170	1290	1750	1750	1600	1560	1190	2530	517	1130	7920	3620
16	1210	1310	1780	1760	1620	1800	1240	2010	527	1230	8120	3610
17	1110	1260	1770	1780	1570	1570	1160	1310	539	1200	7930	3630
18	980	1520	1780	1800	1700	1570	1160	1030	553	1060	7660	3490
19	1080	1580	1740	1820	1810	1580	1070	920	574	910	7450	3240
20	1150	1570	1760	1760	1590	1480	1140	810	576	1440	7190	2640
21	1500	1620	1720	1720	1570	1580	1210	785	597	1980	6900	2490
22	1400	1680	1830	1700	1560	1620	1210	769	612	2900	6830	2900
23	1380	1430	1790	1700	1550	1620	1370	760	620	2270	7090	2800
24	1330	1520	2130	1860	1560	1590	1370	740	616	2860	7010	3700
25	1380	1620	2010	1840	1600	1680	1560	745	618	2490	6160	4040
26	1400	1600	1910	1720	1600	1880	1770	750	576	3040	5150	3810
27	1420	1570	1910	1630	1570	1680	1790	800	587	3370	4630	3830
28	1410	1610	1870	1620	1560	1660	1710	810	591	3678	4630	3650
29	1240	1880	1830	1610	1580	1620	1620	800	619	5000	4380	3530
30	1000	1980	1850	1600	---	1570	1580	775	772	6580	3550	3370
31	1200	---	2080	1580	---	1760	---	765	---	6420	4040	---
MEAN	1260	1350	1770	1750	1560	1580	1400	1180	563	2130	6180	3680

TEMPERATURE, WATER (DEG. C.) WATER YEAR OCTOBER 1987 TO SEPTEMBER 1988
ONCE-DAILY

DAY	OCT	NOV	DEC	JAN	FEB	MAR	APR	MAY	JUN	JUL	AUG	SEP
1	24.0	21.0	18.0	7.0	17.0	20.0	21.0	24.0	25.0	32.0	30.0	30.0
2	25.0	20.0	22.0	8.0	10.0	19.0	22.0	24.0	23.0	30.0	30.0	30.0
3	22.0	23.0	15.0	10.0	11.0	16.0	22.0	25.0	23.0	31.0	31.0	28.0
4	23.0	22.0	15.0	8.0	10.0	18.0	24.0	25.0	25.0	31.0	30.0	26.0
5	23.0	27.0	15.0	8.0	9.0	18.0	23.0	26.0	24.0	30.0	32.0	29.0
6	23.0	20.0	16.0	6.0	10.0	18.0	23.0	25.0	24.0	31.0	32.0	---
7	22.0	19.0	16.0	5.0	9.0	20.0	23.0	24.0	27.0	30.0	32.0	23.0
8	22.0	18.0	20.0	6.0	10.0	18.0	20.0	28.0	28.0	30.0	33.0	23.0
9	24.0	15.0	15.0	5.0	10.0	19.0	19.0	26.0	30.0	31.0	33.0	28.0
10	25.0	22.0	17.0	6.0	11.0	20.0	17.0	28.0	29.0	29.0	31.0	25.0
11	22.0	---	---	9.0	9.0	18.0	25.0	22.0	29.0	28.0	31.0	26.0
12	30.0	15.0	13.0	11.0	11.0	17.0	18.0	17.0	29.0	32.0	30.0	26.0
13	21.0	15.0	11.0	7.0	12.0	18.0	19.0	25.0	27.0	28.0	30.0	29.0
14	22.0	16.0	10.0	7.0	15.0	18.0	22.0	26.0	29.0	30.0	32.0	30.0
15	21.0	15.0	10.0	9.0	13.0	15.0	22.0	27.0	29.0	32.0	31.0	---
16	23.0	15.0	10.0	12.0	13.0	12.0	23.0	27.0	29.0	32.0	32.0	27.0
17	30.0	20.0	9.0	12.0	13.0	13.0	25.0	29.0	30.0	32.0	31.0	28.0
18	23.0	15.0	8.0	12.0	13.0	13.0	22.0	27.0	30.0	---	30.0	28.0
19	22.0	15.0	12.0	14.0	14.0	15.0	23.0	---	30.0	33.0	33.0	29.0
20	19.0	16.0	9.0	10.0	13.0	17.0	---	25.0	27.0	30.0	32.0	29.0
21	20.0	---	12.0	10.0	16.0	19.0	25.0	25.0	30.0	32.0	32.0	31.0
22	19.0	16.0	12.0	10.0	---	20.0	25.0	25.0	31.0	31.0	32.0	28.0
23	20.0	20.0	12.0	12.0	17.0	19.0	25.0	20.0	30.0	31.0	32.0	30.0
24	21.0	---	12.0	16.0	15.0	23.0	22.0	28.0	30.0	31.0	30.0	29.0
25	23.0	17.0	---	8.0	17.0	23.0	26.0	---	31.0	30.0	31.0	31.0
26	22.0	---	9.0	12.0	15.0	22.0	25.0	28.0	28.0	32.0	32.0	29.0
27	23.0	13.0	10.0	10.0	20.0	22.0	24.0	27.0	31.0	32.0	31.0	30.0
28	20.0	13.0	9.0	---	20.0	25.0	22.0	28.0	32.0	32.0	30.0	30.0
29	21.0	12.0	8.0	13.0	20.0	19.0	25.0	27.0	31.0	30.0	30.0	28.0
30	22.0	13.0	10.0	---	---	20.0	22.0	---	25.0	28.0	30.0	22.0
31	---	---	9.0	15.0	---	19.0	---	26.0	---	30.0	29.0	---
MEAN	22.5	17.5	12.0	9.5	13.5	18.5	22.5	25.5	28.0	30.5	31.0	28.0

APPENDIX E

Colorado River Basin

San Saba River at San Saba, Texas

Water Discharge Records

08149000 SAN SABA RIVER AT SAN SABA, TX

LOCATION.--Lat 31°12'47", long 98°43'00", San Saba County, Hydrologic Unit 12090100, on right bank at downstream side of bridge on State Highway 16, 1.2 mi north of San Saba, 2.7 mi upstream from Mill Creek, 4.8 mi downstream from China Creek, and 16.8 mi upstream from mouth.

DRAINAGE AREA.--3,046 mi², of which 6.6 mi² probably is noncontributing.

PERIOD OF RECORD.--December 1904 to December 1906 (gage heights only), September 1915 to current year. Published as "near San Saba" December 1904 to December 1906 and September 1915 to August 1930.

REVISED RECORDS.--WSP 458: 1915-16. WSP 1282: MDR TX-81-3: Drainage area. WSP 1512: 1918-19(M), 1922, 1931(M), 1935 WSP 1922: 1917.

GAGE.--Water-stage recorder. Datum of gage is 1,162.16 ft above National Geodetic Vertical Datum of 1929. See WSP 1922 for brief history of changes prior to July 8, 1953. Since Oct. 1, 1956, supplementary water-stage recorder 2,780 ft to right of main channel gage used for floodflows.

REMARKS.--No estimated daily discharges. Records good. Many diversions above station for irrigation and municipal use affect low flow. Flow partly affected by Brady Creek Reservoir (see station 08149000), capacity 90,300 acre-ft. Several observations of water temperature were made during the year.

AVERAGE DISCHARGE.--73 years, 224 ft³/s (162,300 acre-ft/yr).

EXTREMES FOR PERIOD OF RECORD.--Maximum discharge, 203,000 ft³/s July 23, 1938 (gage height, 39.3 ft, present site and datum), from rating curve extended above 41,000 ft³/s on basis of slope-area measurement of peak flow; no flow at times in 1918, 1930, 1954-56, 1963-64, and 1984. Maximum stage since at least 1899, that of July 23, 1938.

EXTREMES OUTSIDE PERIOD OF RECORD.--Flood of June 6, 1899, reached a stage of 36.7 ft, present site and datum, from information by local residents.

EXTREMES FOR CURRENT YEAR.--Peak discharges greater than base discharge of 3,000 ft³/s and maximum (*):

Date	Time	Discharge (ft ³ /s)	Gage height (ft)	Date	Time	Discharge (ft ³ /s)	Gage height (ft)
July 14	0430	*445	*4.99				

Minimum daily discharge, 17 ft³/s Aug. 17-19, 23, 24.

DISCHARGE, CUBIC FEET PER SECOND, WATER YEAR OCTOBER 1987 TO SEPTEMBER 1988
MEAN VALUES

DAY	OCT	NOV	DEC	JAN	FEB	MAR	APR	MAY	JUN	JUL	AUG	SEP
1	186	101	95	98	96	86	78	48	178	64	42	19
2	136	101	94	100	97	188	74	60	189	47	38	19
3	117	98	94	102	98	184	71	44	174	48	37	20
4	109	98	94	104	91	180	68	41	207	44	30	21
5	105	100	99	102	88	93	61	40	115	42	34	21
6	105	95	101	103	96	82	59	40	85	41	37	19
7	98	87	100	105	105	90	59	41	74	39	34	18
8	93	96	99	106	108	86	61	40	65	37	33	19
9	93	125	94	103	107	83	57	38	59	36	31	20
10	90	220	96	100	106	82	55	33	55	37	27	20
11	89	125	97	101	106	75	61	45	48	50	22	20
12	87	97	94	104	102	66	60	71	42	102	21	18
13	86	88	94	101	99	60	57	78	41	277	22	18
14	87	88	96	100	102	60	59	71	39	393	21	20
15	87	87	95	102	98	60	59	101	38	277	21	21
16	89	109	95	103	100	60	57	80	35	186	19	22
17	88	109	94	101	98	89	56	65	36	137	17	23
18	87	98	93	100	105	69	58	58	35	104	17	27
19	96	89	116	101	114	77	51	61	35	83	17	30
20	100	91	129	97	111	78	49	73	32	69	19	27
21	114	92	128	93	100	75	55	77	28	62	19	25
22	112	94	120	91	95	70	54	75	25	99	19	28
23	101	90	117	92	94	73	51	71	23	53	17	46
24	101	86	117	95	92	74	50	66	20	46	17	42
25	107	88	112	93	91	70	52	63	20	42	17	38
26	107	91	111	91	90	64	58	62	29	39	34	36
27	104	97	108	90	91	62	53	60	34	38	26	30
28	105	103	104	91	92	61	48	55	39	34	22	29
29	103	96	100	94	91	69	46	51	38	33	29	30
30	104	96	100	96	---	74	46	48	62	23	18	53
31	100	---	101	97	---	75	---	51	---	48	28	---
TOTAL	3186	3033	3187	3056	2862	2373	1723	1797	1819	2388	832	779
MEAN	103	101	103	98.6	98.7	76.5	57.4	58.0	60.6	63.8	26.8	26.0
MAX	186	220	129	106	114	188	78	101	207	393	61	53
MIN	86	86	93	90	89	60	46	33	20	33	17	18
AC-FT	6320	6020	6320	6060	5680	4710	3420	3560	3610	5150	1650	1950

CAL YR 1987 TOTAL 67671 MEAN 185 MAX 2420 MIN 41 AC-FT 134200
WTR YR 1988 TOTAL 27245 MEAN 74.4 MAX 393 MIN 17 AC-FT 54040

APPENDIX F

Central Texas Council of Governments

Memorandum



A VOLUNTARY ASSOCIATION OF LOCAL GOVERNMENTS

CENTRAL TEXAS COUNCIL OF GOVERNMENTS

BELL COUNTY COURTHOUSE EAST

PHONE 817/939-1801

P. O. BOX 720

BELTON, TEXAS 76513

MEMORANDUM

SUBJECT: Texas Water Development Board Population and Water Requirements Projections

TO: Central Texas Regional Governments

FROM: A. C. Johnson, Executive Director 

DATE: May 10, 1989

The TWDB, in preparing to update the Texas Water Plan, has developed population and water use projections by decade, for 1990 - 2040. They requested that CTCOG act as a regional point of contact to obtain comments from our regional governments.

We enclose, for each county, a full set of data for the county, including data for the major cities in the county. For each city (and Fort Hood) we enclose data for that entity, and overall county projections. Please review the population and water use projections. Upon receipt of all comments we will consolidate them and forward them to TWDB. If possible, have your comments to us by 22 May.

If you have any question, please call Jerry Bunker, 939-1801.

TEXAS WATER DEVELOPMENT BOARD
 WATER DATA COLLECTION, STUDIES, AND PLANNING DIVISION

PROJECTIONS OF POPULATION AND MUNICIPAL WATER DEMANDS
 HIGH PER CAPITA WATER USE SERIES
 SEPTEMBER, 1988

UNITS: WATER IN ACRE-FEET
 POPULATION IN NUMBER OF PERSONS

DRAFT - SUBJECT TO REVISION

COUNTY: 167 MILLS
 C.O.G.: 23 CENTRAL TEXAS COUNCIL OF GOVERNMENTS

CITY	+	GW	1980 SW	TOTAL	+	GW	1985 SW	TOTAL	+	1990	2000	2010	2020	2030	2040
* GOLDTHWAITE	*				*				*						
POPULATION	*				*				*						
LOW SERIES	*			1783	*			1874	*	1924	2142	2237	2291	2339	2364
HIGH SERIES	*				*				*	1945	2191	2289	2352	2417	2451
MUNICIPAL (1)	*				*				*						
LOW	*	162	357	519	*	142	81	223	*	584	650	679	695	710	718
HIGH	*				*				*	590	665	695	714	734	744
MUNICIPAL (2)	*				*				*						
LOW	*				*				*	569	601	594	591	604	610
HIGH	*				*				*	576	615	608	607	624	632
* OTHER	*				*				*						
POPULATION	*				*				*						
LOW SERIES	*			2694	*			2653	*	2638	2714	2843	2934	3001	3033
HIGH SERIES	*				*				*	2665	2775	2908	3012	3101	3144
MUNICIPAL (1)	*				*				*						
LOW	*	316	0	316	*	316	3	319	*	423	435	456	470	480	486
HIGH	*				*				*	427	444	466	482	497	504
MUNICIPAL (2)	*				*				*						
LOW	*				*				*	412	402	399	399	408	413
HIGH	*				*				*	416	411	408	410	422	428
* COUNTY TOTAL	*				*				*						
POPULATION	*				*				*						
LOW SERIES	*			4477	*			4527	*	4562	4856	5080	5225	5340	5397
HIGH SERIES	*				*				*	4610	4966	5197	5364	5518	5595
MUNICIPAL (1)	*				*				*						
LOW	*	478	357	835	*	458	84	542	*	1007	1065	1135	1165	1190	1204 - 199 GPD
HIGH	*				*				*	1017	1109	1161	1196	1231	1248
MUNICIPAL (2)	*				*				*						
LOW	*				*				*	981	1003	993	990	1012	1023
HIGH	*				*				*	992	1026	1016	1017	1046	1060

(1) ASSUMES HIGH PER CAPITA WATER USE WITHOUT ADDITIONAL CONSERVATION.
 (2) ASSUMES HIGH PER CAPITA WATER USE WITH CONSERVATION PRACTICES.

TEXAS WATER DEVELOPMENT BOARD
 WATER DATA COLLECTION, STUDIES, AND PLANNING DIVISION

PROJECTIONS OF POPULATION AND MUNICIPAL WATER DEMANDS
 AVERAGE PER CAPITA WATER USE SERIES
 SEPTEMBER, 1988
 DRAFT - SUBJECT TO REVISION

UNITS: WATER IN ACRE-FEET
 POPULATION IN NUMBER OF PERSONS

COUNTY: 167 MILLS
 C.O.G.: 23 CENTRAL TEXAS COUNCIL OF GOVERNMENTS

CITY	GW	1980 SW	TOTAL	GW	1985 SW	TOTAL	1990	2000	2010	2020	2030	2040

GOLDTHWAITE POPULATION												
LOW SERIES			1783			1874	1924	2142	2237	2291	2339	2364
HIGH SERIES							1945	2191	2289	2352	2417	2451
MUNICIPAL (1)												
LOW	162	357	519	142	81	223	502	559	584	598	610	617
HIGH							508	572	597	614	631	640
MUNICIPAL (2)												
LOW							490	517	511	508	519	524
HIGH							495	529	523	522	536	544

OTHER POPULATION												
LOW SERIES			2694			2653	2638	2714	2843	2934	3001	3033
HIGH SERIES							2665	2775	2908	3012	3101	3144
MUNICIPAL (1)												
LOW	316	0	316	316	3	319	325	335	350	361	370	373
HIGH							328	342	358	371	382	387
MUNICIPAL (2)												
LOW							316	309	306	307	314	318
HIGH							320	316	313	316	325	330

COUNTY TOTAL POPULATION												
LOW SERIES			4477			4527	4562	4856	5080	5225	5340	5397
HIGH SERIES							4610	4966	5197	5364	5518	5595
MUNICIPAL (1)												
LOW	478	357	835	458	84	542	827	894	934	959	980	990
HIGH							836	914	955	985	1013	1027
MUNICIPAL (2)												
LOW							808	826	817	815	833	842
HIGH							815	845	836	838	861	874

(1) ASSUMES AVERAGE PER CAPITA WATER USE WITHOUT ADDITIONAL CONSERVATION.
 (2) ASSUMES AVERAGE PER CAPITA WATER USE WITH CONSERVATION PRACTICES.

TEXAS WATER DEVELOPMENT BOARD
 WATER DATA COLLECTION, STUDIES, AND PLANNING DIVISION

PROJECTIONS OF POPULATION AND WATER DEMANDS
 SEPTEMBER, 1988

UNITS: WATER IN ACRE-FEET
 POPULATION IN NUMBER OF PERSONS

DRAFT - SUBJECT TO REVISION

COUNTY: 167 MILLS
 C.O.G.: 23 CENTRAL TEXAS COUNCIL OF GOVERNMENTS

CATEGORY	1980			1985			1990	2000	2010	2020	2030	2040
	GW	SW	TOTAL	GW	SW	TOTAL						
POPULATION												
LOW SERIES			4477			4527	4562	4856	5080	5225	5340	5397
HIGH SERIES							4610	4966	5197	5364	5518	5595
MUNICIPAL (1)												
LOW	478	357	835	457	84	541	827	894	934	959	980	990
HIGH							836	914	955	985	1013	1027
MUNICIPAL (2)												
LOW	478	357	835	457	84	541	806	826	817	815	833	842
HIGH							815	845	836	838	961	874
MANUFACTURING												
LOW	0	0	0	0	0	0	0	0	0	0	0	0
HIGH							0	0	0	0	0	0
STEAM ELECTRIC												
LOW	0	0	0	0	0	0	0	0	0	0	0	0
HIGH							0	0	0	0	0	0
IRRIGATION												
LOW	300	2970	3270	41	2037	2078	2235	2235	2235	2235	2235	2235
HIGH							2378	2378	2378	2378	2378	2378
MINING	0	0	0	0	0	0	0	0	0	0	0	0
LIVESTOCK	562	525	1087	302	302	604	1269	1452	1452	1452	1452	1452
TOTAL (1)												
LOW	1340	3852	5192	800	2423	3223	4331	4581	4621	4646	4667	4677
HIGH							4483	4744	4785	4815	4843	4857
TOTAL (2)												
LOW	1340	3852	5192	800	2423	3223	4310	4513	4504	4502	4520	4529
HIGH							4462	4675	4666	4668	4691	4704

(1) ASSUMES AVERAGE PER CAPITA WATER USE WITHOUT ADDITIONAL CONSERVATION.
 (2) ASSUMES AVERAGE PER CAPITA WATER USE WITH CONSERVATION PRACTICES.

TEXAS WATER DEVELOPMENT BOARD
 WATER DATA COLLECTION, STUDIES, AND PLANNING DIVISION
 PROJECTIONS OF POPULATION AND WATER DEMANDS
 SEPTEMBER, 1988

UNITS: WATER IN ACRE-FEET
 POPULATION IN NUMBER OF PERSONS

DRAFT - SUBJECT TO REVISION

COUNTY: 167 MILLS
 C.O.G.: 23 CENTRAL TEXAS COUNCIL OF GOVERNMENTS

CATEGORY	* *	GW	1980 SW	TOTAL *	* *	GW	1985 SW	TOTAL *	* *	1990	2000	2010	2020	2030	2040
POPULATION															
LOW SERIES				4477				4527		4562	4856	5080	5225	5340	5397
HIGH SERIES										4610	4966	5197	5364	5518	5595
MUNICIPAL (1)															
LOW		478	357	835		457	84	541		1007	1085	1135	1165	1190	1204
HIGH										1017	1109	1161	1196	1231	1248
MUNICIPAL (2)															
LOW		478	357	835		457	84	541		981	1003	993	990	1012	1023
HIGH										992	1026	1016	1017	1046	1060
MANUFACTURING															
LOW		0	0	0		0	0	0		0	0	0	0	0	0
HIGH										0	0	0	0	0	0
STEAM ELECTRIC															
LOW		0	0	0		0	0	0		0	0	0	0	0	0
HIGH										0	0	0	0	0	0
IRRIGATION															
LOW		300	2970	3270		41	2037	2078		2235	2235	2235	2235	2235	2235
HIGH										2378	2378	2378	2378	2378	2378
MINING		0	0	0		0	0	0		0	0	0	0	0	0
LIVESTOCK		562	525	1087		302	302	604		1269	1452	1452	1452	1452	1452
TOTAL (1)															
LOW		1340	3852	5192		800	2423	3223		4511	4772	4822	4852	4877	4891
HIGH										4664	4939	4991	5026	5061	5078
TOTAL (2)															
LOW		1340	3852	5192		800	2423	3223		4485	4690	4680	4677	4699	4710
HIGH										4839	4856	4846	4847	4876	4890

(1) ASSUMES HIGH PER CAPITA WATER USE WITHOUT ADDITIONAL CONSERVATION.
 (2) ASSUMES HIGH PER CAPITA WATER USE WITH CONSERVATION PRACTICES.