

**POWER GENERATION WATER USE IN TEXAS
FOR THE YEARS 2000 THROUGH 2060**

FINAL REPORT

**PREPARED FOR THE
TEXAS WATER DEVELOPMENT BOARD**

**BY REPRESENTATIVES OF
INVESTOR-OWNED UTILITY COMPANIES OF TEXAS**

January 2003

TABLE OF CONTENTS

TABLE OF CONTENTS	i
EXECUTIVE SUMMARY	iii
SECTION I: TYPES OF ELECTRIC POWER GENERATION PLANTS AND THEIR	
WATER NEEDS	1
A. Introduction	1
B. Types of Power Plants	1
Steam Turbines.....	1
Gas Turbines	2
Combined Cycle.....	2
Nuclear	2
Hydroelectric	3
Alternate Technology.....	4
C. Steam Electric Plant Water Needs.....	5
Boiler Turbine Cycle.....	5
Pollution Control Systems – Sulfur Oxide (SO _x Systems).....	7
Particulate Control Systems – Coal Ash	7
Solid Waste Disposal Systems	8
Other Electric Generation Water Usage.....	8
D. Gas Turbine Electric Plant Water Needs.....	8
Nitrogen Oxide (NO _x) Control Systems	8
Cooling Systems.....	9
SECTION II: ESTIMATING ELECTRIC POWER GENERATION WATER USE	10
A. Estimation of Water Used by Cooling Systems	10
Reservoir Use For Cooling.....	10
Wet-Type Cooling Tower Use For Cooling.....	12
Dry-Type Cooling Tower (Radiator) Use For Cooling.....	13
B. Determination of Estimating Factors for Total Electric Generation Water Use	14
Steam Turbine Electric Generating Plants	14
Gas Turbine Electric Generating Plants	15
Combined Cycle Electric Generating Plants	15
Coal-Fueled Electric Generating Plants	16
Nuclear-Fueled Electric Generating Plants	16
Gasified Fluidized Bed Generating Plants	16
SECTION III: STATEWIDE ELECTRIC GENERATION PROJECTIONS	17
Introduction	17
Derivation of Electric Demand Growth Rate Using PUCT Generation Projections	17
Derivation of Per Capita Electric Demand and Per Capita Demand Growth Rate ...	18

Comparison of Total Statewide Electric Demand Projections Using PUCT Growth Rate Factor Versus Using Per Capita Electric Demand Growth Rate and TWDB Population Projections	20
Recommendation of Methodologies for Projecting Statewide and Per Capita Electric Demands.....	20
Statewide Electric Generation Demand Projections	21
SECTION IV: WATER SOURCES CURRENTLY IN USE.....	23
SECTION V: ESTIMATES OF FUTURE WATER USE AND STATEWIDE STEAM ELECTRIC WATER DEMAND PROJECTIONS.....	24
High Use Scenario.....	25
Medium Use Scenario	26
Low Use Scenario	26
Adjustments to the Scenarios	27
SECTION VI: STEAM ELECTRIC WATER DEMAND ON A REGIONAL AND COUNTY BASIS.....	28
Difficulties in Allocating Steam Electric Water Demand on a Regional or County Basis	28
Methodology Recommended	29
SECTION VII: CONCLUSIONS	35
SECTION VIII: APPENDICES	
Appendix A	Electric Generating Units in Texas
Appendix B	Projected Electrical Demand and Population Growth in Texas
Appendix C	Steam Electric Water Supplies, Demands, and Shortages per the 2002 State Water Plan
Appendix D	Comparison of Steam Electric Water Supply and Demand
Appendix E	Projected Electrical Demand Per State and Federal Agencies
Appendix F	Comparison of Previous Projections for Future Water Use by Electric Generation
Appendix G	Glossary of Electricity Terms
Appendix H	Executive Administrator’s Comments on Draft Report

EXECUTIVE SUMMARY

The objective and purpose of the research project is to develop improved methodologies for projecting water demands by the steam electric generation water use sector for a 50 year planning horizon, as well as actual projections for this sector on a regional and county specific basis throughout the state of Texas. Such projections and methodologies will be utilized by the Texas Water Development Board (TWDB) and the Regional Water Planning Groups (RWPGs) for state and regional water planning purposes.

This research was conducted pursuant to a contract executed by and between the TWDB and a research project team comprised of representatives of major investor-owned electric generating utilities in Texas. The actual contracting entity for the project team and project team leader was the Austin-based law firm of Lloyd, Gosselink, Blevins, Rochelle, Baldwin & Townsend, P.C. Lloyd, Gosselink is a leading environmental services law firm with a proven track record of success on water-related project leadership. The other project team members included representatives of the three largest generators of electricity in the state of Texas: American Electric Power, TXU Energy, and Reliant Energy.

The project team was uniquely qualified to undertake research for the development of electric generation water demand projection methodologies, as team members were selected on the basis of their training, institutional knowledge, and understanding of long-term trends in electric generation in Texas, trends in generation technologies, and related water usage. Members of the project team have already been intricately involved in the regional water planning process as members of various RWPGs, and as alternates, technical support, and liaisons to other RWPGs. In those capacities, they have also already been involved in the calculation of demand projections for the steam electric sector utilized in the first regional water planning cycle (post-Senate Bill 1 of 1997, which created the RWPG process).

This paper describes various types of current electric generation technologies, such as gas turbines, steam turbines, and others, and the water-utilizing processes within each technology. Estimates of the varying amounts of water consumed by each generation technology in the production of electricity are also provided. The paper then evaluates the various cooling technologies, such as once-through cooling and cooling towers, in combination with the above generation technologies and derives estimations of the amount of water that each of them consumptively use per unit of electricity generated. These consumption factors allow an accurate determination of the total annual water consumption at a particular facility based upon its reported actual generation, once its generation and cooling technologies have been identified.

The project team first developed a methodology and specific water demand projections for the power generation on a statewide basis. The statewide approach was deemed to be more reliable than any localized approach for two primary reasons: (1) the availability of statewide electric generation data projections; and (2) the fact that, because of electric transmission technologies and other regulatory constraints unrelated to water, the location

of the generation facility (and, thus the location of the steam-electric water demand) is not necessarily related to the location of the demand for the electricity.

In order to develop statewide water demand projections for power generation, it was first necessary to develop projections for statewide electric demands, assuming once again that generation to meet those demands would occur in Texas. The project team developed two different methodologies for projecting statewide electric demand: (1) derivation of an electric demand growth factor from the electric demand projections developed by the Public Utility Commission of Texas (PUCT), and extrapolation of the factor across the 50-year planning horizon; and (2) derivation of a per capita electric use factor from existing population and total electric use data from the past two decades, and utilization of that per capita factor with the TWDB population projections to project total electric use through the year 2060. The two methodologies proved to yield significantly similar results, although the first methodology and its projections were selected as the most reliable and were used for the remainder of the research effort.

Utilizing those statewide electric demand projections and the consumptive water use factors associated with the various types of generation and cooling technologies, water use demand projections were developed using low-, medium-, and high-use scenarios through the year 2060. Each scenario was defined according to a combination of various assumptions related to the continuation or retirement of existing facilities and the percentage of future statewide electric generation that would be met by various generation and cooling technologies. The medium-use scenario was selected as the most probable predictor of future statewide water demand for power generation.

To determine the water demand for electric power generation on a county and regional basis, the statewide water demand projections derived under the medium use-scenario were utilized in combination with an exhaustive assimilation of actual fuel-type and cooling technology generation data for 214 electric utility and independent power producer plants in Texas, with 79 of those plants being placed in service, constructed or announced since 2000. The methodology utilized does not lend itself to summary explanation, although a few general descriptions of it may be proffered for summary purposes.

The water demand for each electric generating plant in Texas was estimated as a percentage of the statewide demand. For the baseline year 2000, the water demand for each plant was calculated by taking the actual generation by fuel type and applying the water use factor for the generating units at that plant for each fuel type.

Once the baseline year 2000 water demand was determined for each generation unit, water demand projections for the years 2010 through 2060 were also calculated on a unit-by-unit basis. Because of the availability of specific electric generation projection data by fuel type from other governmental agencies for the period of 2001 through 2020 and the lack of such data thereafter, these unit-specific water demand projections were derived by one methodology for the years 2010 and 2020 and a separate methodology for

years 2030 through 2060. The methodologies utilized are discussed in greater detail in Section VI with illustrative examples provided.

For the years 2010 and 2020, the estimated water demand for coal-fired, nuclear, and conventional natural gas units was based on the 2000 water demand and was adjusted by a correction factor based upon a linear trending of the unit based upon its fuel type and projections of generation based on fuel types. Projections for natural gas fired combined cycle generation were also derived by taking the difference in the statewide totals and the trended totals from the conventional generation types, which was then apportioned to individual combined cycle plants.

For the decades 2030 through 2060 the water demand for each plant was projected to increase at the same rate throughout the state regardless of fuel type and generation type.

In order to calculate the county water demand projection for a given year, simply sum the total of all the individual plant projections located in that county for the same year. Similarly, to determine the water demand projection within a RWPG in a given year, sum the county totals for all of the counties included within the water planning region.

Other than the specific decadal water demand projections and methodologies, other results of the research may be of particular interest to the water resource planner. For example, while the research clearly indicates that the statewide electric demand is projected to increase by two percent annually for a total increase of 234 percent in 2060 over the year 2000 electric generation demand, the corresponding water demand would increase by only 162 percent over the same planning horizon due to the utilization of more efficient generation technologies. Also of interest is that the statewide water demand projections developed indicate that all surpluses of water currently held for steam electric generation will be exhausted by 2037.

With the number of indeterminable variables associated with the development of statewide steam-electric water demand projections on a 50-year planning horizon, no methodology can be developed that will result in a perfect, predictive tool. The lack of a necessary correlation between the location of the water demand and the location of the demand for the electricity generated with that water, which is particularly acute in the steam-electric sector, renders attempts to localize or regionalize such demand projections even less reliable. Nonetheless, the research, methodologies, and projections developed and presented in this report represent the most comprehensive effort to date to establish such generalized methodologies and to assimilate such information for the steam-electric sector in Texas.

Respectfully submitted,

Brian L. Sledge
Lloyd, Gosselink, Blevins, Rochelle,
Baldwin & Townsend, P.C.

W. Greg Carter
American Electric Power

Chris A. Bissett
American Electric Power

Kerry M. Whelan
Reliant Energy

Jason Fluharty
Reliant Energy

Joseph Simecek
TXU Energy

Paul Zweiacker
TXU Energy

SECTION I: TYPES OF ELECTRIC POWER GENERATION PLANTS AND THEIR WATER NEEDS

A. Introduction

There are a number of technologies employed throughout the state of Texas to generate electricity. The various processes associated with these generation technologies consumptively use varying amounts of water, with water that is utilized in the cooling process consuming the largest percentage of that water. Because the amount of cooling necessary for the power generation facility is largely dependent on the type of device used to power the electric generator and because additional amounts of water for purposes other than cooling are consumed in some generation processes, a basic understanding of these generation technologies and their water-consuming processes is integral to this research and is set forth below.

B. Types of Power Plants

Steam Turbines

Many of the electric generation facilities in Texas use steam turbines as the prime mover to drive the electric generators. Boilers, which are fueled by natural gas, fuel oil, coal, or in some cases, nuclear reactors, produce the steam for the turbines. Steam turbines are commonly used because they are efficient, reliable, and available in the large sizes necessary for powering large electric generators. Steam turbines and boilers are also used because the working fluid is water, which is relatively easy to purify and relatively abundant. Due to the need to condense the steam, the cooling requirements of steam turbines can be greater than those of other types of power systems. A basic process diagram of a power plant utilizing a steam turbine is set forth in Figure 1-1.

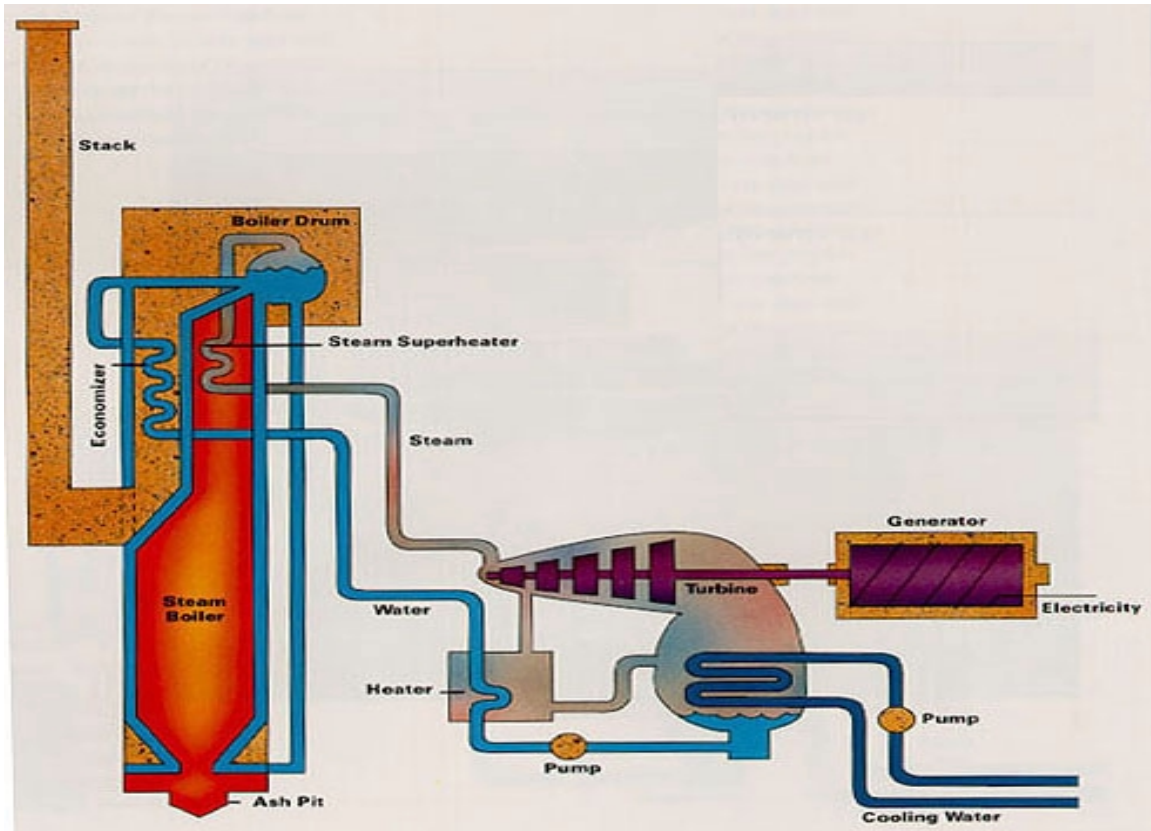

Figure 1-1 Steam-Electric Power Plant

Gas Turbines

Other generation facilities use gas turbines as the prime mover to drive the electric generators. Gas turbines are large aircraft derived jet engines and are usually fueled by natural gas. Gas turbines have relatively small cooling systems when compared to steam turbines. Many gas turbines use water or steam injection to control emissions of nitrogen oxides. The water or steam is injected into the combustion area of the turbine to drop the flame bundle temperature and reduce the amount of nitrogen oxide (NO_x) produced. The water or steam injected must be very pure with minimal amounts of contamination.

Combined Cycle

Many of the newer generation facilities in Texas are a combination of gas turbine and steam turbine generation called “combined cycle” power plants. In this type of power plant, one or more gas turbines exhaust hot gases from the gas turbine through a heat recovery steam generator that uses the waste heat to generate steam. The steam is then used to power a steam turbine. Each gas turbine drives an electric generator and the steam turbine also drives an electric generator. Combined cycle power plants are more efficient than either gas turbine or steam turbine generators operated independently.

Nuclear

Nuclear-fueled power plants are very similar to natural gas, oil, or coal fired steam turbine power plants. A nuclear-fueled power plant uses a nuclear reactor to generate

steam to power a steam turbine. The steam turbine, as well as the rest of the power plant, is very similar in design to a gas or coal-fired steam electric power plant. A diagram of a typical nuclear-fueled plant configuration is set forth under Figure 1-2.

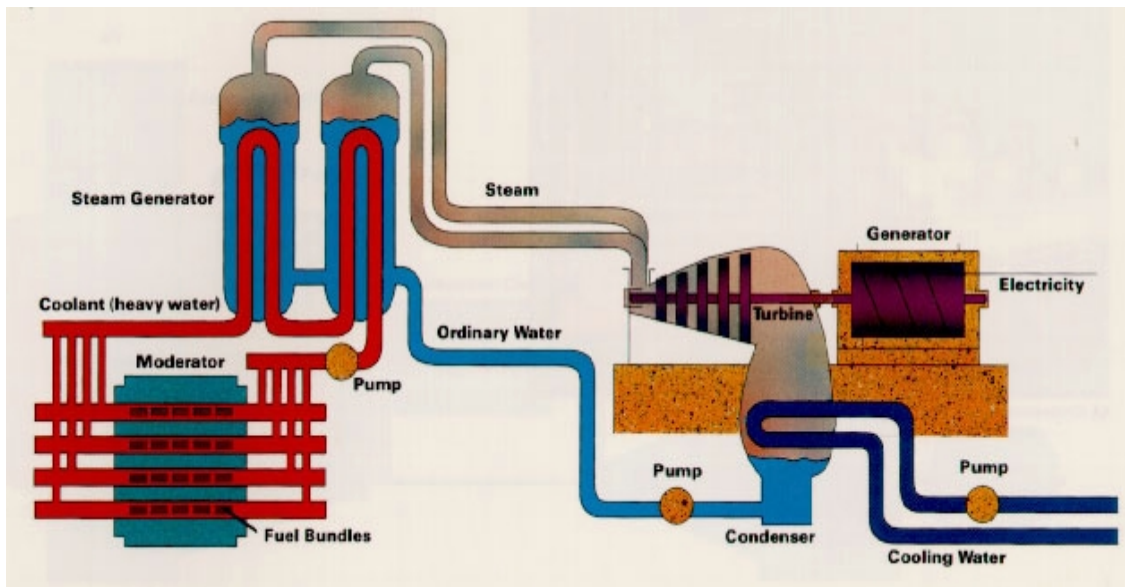

Figure 1-2 Nuclear-Fueled Power Plant

Hydroelectric

Some of the electric generation in Texas is produced through hydroelectric facilities. As shown in Figure 1-3, these facilities produce power when water is released from a reservoir and the water passes through a water turbine, which in turn drives an electric generator. In most cases in Texas, the release of water from a reservoir through a water-powered turbine occurs only when the release from the reservoir is required by downstream use or for flood control measures. In this case, the power generation is secondary to another need for the release. In addition, there are also several small run-of-the-river hydroelectric facilities throughout the state. These facilities do not rely on the release of water from a reservoir, but instead utilize the force of a river current to drive the water-powered turbine.

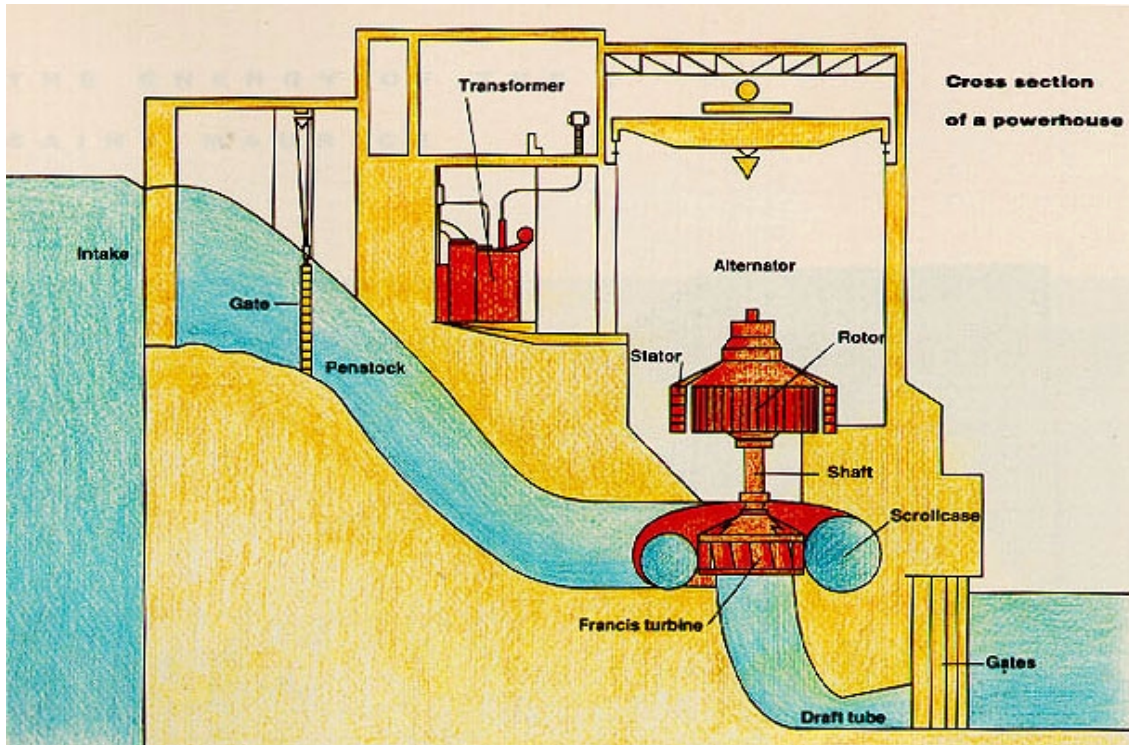

Figure 1-3 Hydroelectric Power Plant

Alternate Technology

Some generation facilities use little or no water to generate power. Wind turbine (see Figure 1-4) and solar panel power generation are two types of electric generation with little water demand. However, this type of power generation is currently only a very small percentage of the power produced in Texas. Internal combustion engines powered by diesel fuel generally use small amounts of cooling water because of their smaller sizes and alternate cooling mechanisms. Finally, fuel cells have the potential to generate electric power with very little consumption of water if they can be produced and maintained in an economically viable manner.



Figure 1-4 Wind Turbine Farm

C. Steam Electric Plant Water Needs

Boiler Turbine Cycle

The use of water for the dissipation of heat is a necessary part of the thermodynamic cycle of all modern steam electric power plants. Its value for this purpose lies in its high specific heat, its general abundance and its ability to consume heat in the evaporation process.

In the modern steam electric power plant, whether nuclear or fossil fueled, steam from the boiler flows through the turbine giving up energy to the turbine rotor and cooling in the process. At the exhaust of the turbine, the steam must be condensed and returned to the boiler. This is accomplished in the condenser using cooling water and in the process the cooling water temperature is increased. Although some water is also used in other processes in the power plant, particularly for boiler make-up, the quantities are insignificant when compared with that consumed for condensing the used steam. The increase in the temperature of the cooling water flowing through the condenser depends upon the design of the condenser, but it is usually between 15 and 25 degrees F.

For a given rate of heat removal, the temperature rise in the cooling water is inversely proportional to the amount of water pumped through the condenser. The size of the condenser and the amount of water circulated can vary substantially. The design values are selected on the basis of a complex economic analysis which takes into account factors such as the cost of fuel, the cost of money, expected operating schedules, water temperature, meteorological data and site conditions, all being part of the optimization process in plant design which will result in a plant with the lowest production cost. The range in water flow rates for modern plants is between 20 and 60 gallons per kilowatt hour (kWh) generated, the lower rate being associated with very efficient plants and the higher rate being that of the larger commercial nuclear plants now in operation.¹

Power plant efficiencies are expressed in terms of the plant heat rate, which is the British Thermal Units (BTU) required to generate each net kWh at the terminals of the plant generator. A “perfect” plant would have a heat rate of 3413 BTU/kWh, meaning that all of the heat energy that went into the system was converted into electrical energy. The most efficient technology available today can achieve a heat rate of approximately 6500 BTU/kWh, which is equivalent to an efficiency of about 53 %. There are many older plants with much higher heat rates, but the national average heat rate is about 10,300 BTU/kWh.² Most of the inefficiencies that occur in the generation of electricity come from the need to dissipate heat in the cooling process. In fossil-fueled plants, between 10% and 15% of the heat entering with the fuel is lost in the boiler, while the remainder is lost in the cooling process. In nuclear plants, which do not lose heat through combustion emissions, cycle cooling accounts for almost the entire loss. In the “average”

¹ *Water and Sustainability (Volume 3): U.S. Water Consumption for Power Production –The Next Half Century*, Electric Power Research Institute, Palo Alto, CA: 2002 at pages 3-1 to 3-2. Also Figures 2-1, 2-2, and 2-3 were utilized from the EPRI report.

² Information provided by the National Electric Reliability Council.

United States electric generating plant, possibly 8800 BTU of the 10,300 BTU/kWh entering in the fuel would reach the turbine. Of this, 3413 BTU leaves as electricity and the balance, about 5400 BTU, is removed in the condenser. If this were a nuclear plant, the heat removed in the condenser would be about 7000 BTU/kWh. This is indeed typical of “first-generation” nuclear plants. In the latest, most efficient supercritical fossil-fueled units, on the other hand, the heat removal in the condenser may be as low as 3600 BTU/kWh. Thus the range of heat removal rates in the condensers of large modern plants is between about 4000 and 7000 BTU/kWh generated.³

The heat added to the water as it flows through the condenser must be allowed to dissipate externally from the system in some way. The process of “once-through cooling” occurs where cooling water is pumped from a water body through a condenser and subsequently returned to a receiving body. Where the cooling water is returned to a natural watercourse, reservoir, bay, or other water body, this dissipation of heat is accomplished by evaporation, radiation, conduction, convection, and advection.⁴ If the heat is dissipated in a wet-type cooling tower, it is almost entirely by the evaporation of water. In a dry-type cooling tower, the heat dissipation is almost entirely by conduction and convection.⁵

It is advisable to make a distinction between the terms “consumption” and “use” as applied to water. As noted, the removal of heat in the condenser requires the circulation of large quantities of water, but except for its increase in temperature this water is unchanged in quality and is therefore still useable for other purposes. If the heat that is added, however, is dissipated partly by evaporation, the evaporated water cannot be reused and must be considered as having been consumed.

An alternative to using once-through cooling systems or cooling towers is use of a radiator system. This closed-loop system works in the same way that a radiator cools an automotive engine. Airflow through the radiator cools the water inside the radiator system. The cooled water flows back through the plant systems and collects heat from those systems. The warm water returns to the radiator and is cooled by airflow again. Although the radiator system is very conservative of water, it is not nearly as efficient at heat removal as a once-through or cooling tower system. This loss of efficiency results in a reduction in the amount of electric power available from a plant cooled by radiators and also reduces the thermal efficiency of the plant. However, the water demand of the plant is reduced to 10% of the cooling water requirement of a wet cooling tower. Water use is not totally eliminated, but it is greatly reduced.

³ See generally Drew, H.R., A Projection of Per Capita Water Use for Electric Power Generation in Texas, prepared for the Texas Water Commission, May 15, 1965.

⁴ See Harbeck, Koberg, and Hughes, The Effect of the Addition of Heat From A Power Plant On The Thermal Structure And Evaporation of Lake Colorado City, Texas, Geological Survey Paper 272-B, U.S. Department of the Interior, 1959, at page 25.

⁵ See description of wet-type and dry-type cooling towers in Section II, *infra*.

Pollution Control Systems – Sulfur Oxide (SOx Systems)

Coal-fired power plants are required to use various pollution control systems to improve the quality of boiler emissions to the atmosphere. One pollution control strategy requires control of sulfur oxide (SOx) emissions. Sulfur oxides are removed from coal-fired boiler gases by passing the gases through a spray of limestone slurry. The gases react with the limestone and the chemical and physical reaction removes SOx from the gas stream. Much of the moisture in the slurry is evaporated and carried out of the boiler stack by the gas stream. This results in a consumption of water.

The U.S. Department of Energy has estimated⁶ the amount of water used by a 500 megawatt (MW) coal-fired boiler burning bituminous coal with a sulfur content of about 2% for three types of scrubber systems⁷. In a magnesium lime-based process, a total of about 666 gallons per minute (gpm) of water leaves the system. Most of this (587 gpm) is evaporation to the flue gas. If the process is limestone-inhibited oxidation, the evaporation to the flue gas is also 587 gpm. If the process is limestone forced-oxidation, the evaporation to the flue gas is 668 gpm. Measurement data at several coal-fueled generating plants has yielded a water use factor of 1 gallon per minute per megawatt of generation for SOx pollution control systems. For example a 500 MW unit would evaporate 500 gpm when scrubbing at full load. This equates to 0.06 gallons/kWh.

Pollution Control Systems – Nitrogen Oxide (NOx Systems)

Nitrogen oxide (NOx) control for fossil-fueled boilers is accomplished with a variety of methods applied to the furnace area of the boiler. Most of these methods do not use water, but instead use air and gas circulation to accomplish NOx reduction.

As NOx emission limits are pushed ever lower, new technology for NOx reduction has evolved. One of the newer methods being used is selective catalytic reduction (SCR). This method of NOx reduction involves injection of either urea or ammonia into the exhaust from a gas turbine or boiler to activate a catalytic process. The water consumption rate for SCR technology that utilizes a urea conversion system and sparge steam is 0.0121 gallons/kWh. It should be noted that this is only one type of system and the water consumption rates for other types of systems may be different. Technology exists that uses a specific burner design to limit nitrogen oxides (NOx) without the use of water or steam injection. This is termed dry NOx combustion. The water consumption for this type of technology is essentially zero. There may be some water use associated with equipment cooling, but it is minimal.

Particulate Control Systems – Coal Ash

Particulate control at a coal-fired plant is concerned with fly ash, economizer ash, and bottom ash products. Several power stations handle fly ash and economizer ash in a dry

⁶ U.S. Department of Energy, Pittsburgh Energy Technology Center entitled Electric Utility Engineer's FGD Manual; prepared by Radian International LLC; Grant No. DE-FG22-94PC94256; May 1996.

⁷ Ibid. at Table 3-1 ("Typical Terms in a Lime/ Limestone Flue Gas Desulfurization (FGD) Process Water Balance); page I.3-35.

form and no water loss is associated with these systems. Bottom ash is normally handled in a slurry, which results in some water use. Water use for a 600 MW coal-fired unit is estimated to be approximately 2,500 acre-feet per year.⁸ This equates to approximately 0.155 gallons per kWh.

Particulate control at gas or oil-fueled generating plants is very minimal, and no appreciable water use is associated with particulate control at these plants. Minimal amounts of water are used at coal-fired power stations for dust suppression at their coal stock pile.

Solid Waste Disposal Systems

In addition to ash by-products, the only other appreciable solid waste that occurs at some coal-fired generation facilities is flue gas desulfurization (FGD) solids. Normally, this material is placed in landfills or ponds, which are capped after they are full. The water loss associated with these ponds can be estimated by referencing the Texas Water Development Board (TWDB) evaporation/precipitation data for Texas.

Solid waste disposal at gas and oil-fired power stations is minimal and associated water loss is negligible.

Other Electric Generation Water Usage

Generation facilities utilize minimal amounts of water for a variety of other purposes. For example, some amounts of water may be consumed in the process of purifying the water needed for boiler-makeup. Facilities also use minimal amounts of water for potable purposes, which is often supplied through contract with municipalities and other water suppliers, or by a private water well. For purposes of this research and the determination of steam-electric water demands, consideration of this usage will be omitted.

D. Gas Turbine Electric Plant Water Needs

Nitrogen Oxide (NO_x) Control Systems

Gas turbine driven electric generators are limited by State and Federal law to specific levels of nitrogen oxide emissions to the atmosphere. NO_x can be controlled in several ways. Injecting water or steam into the combustion area of the gas turbine can control NO_x emissions. The water or steam reduces the maximum combustion temperature of the fuel and air mixture and thereby reduces the emission rate of NO_x. The water or steam used for injection must be of extremely pure quality, which requires rather elaborate purification equipment. The water consumption rates for NO_x control systems on gas turbines have been measured in the range of 0.05 to 0.07 gallons of water consumed per kilowatt-hour of electric power produced.⁹ For a 172 MW gas turbine, this equates to a water consumption rate of approximately 10,837 gallons per hour or 0.063 gallons per kWh produced.

⁸ Internal estimates of electric generating utilities on project team.

⁹ *Ibid.*

Cooling Systems

Gas turbine powered generating systems require water for equipment cooling, but because there is no need to condense large amounts of steam, the cooling systems are much smaller than those found in steam electric generating plants. The most common method of cooling the equipment is a cooling tower, and occasionally a reservoir. Water use associated with this process is relatively small.

SECTION II: ESTIMATING ELECTRIC POWER GENERATION WATER USE

A. Estimation of Water Used by Cooling Systems

Reservoir Use For Cooling

A pioneering study by G. Earl Harbeck at Lake Hefner, Oklahoma City, Oklahoma, utilizing energy budget and mass transfer analyses, demonstrated that the increase in evaporation from the lake was directly proportional to the amount of heat added to the lake by the power plant adjacent to it. The study indicated that the heat added to the lake was dissipated in the following manner:

- 1% by advection out of the body of water;
- 15% by long wave radiation emitted by the body of water;
- 54% by evaporation;
- 28% by conduction from the body of water as sensible heat; and
- 2% by energy advected by the evaporated water.¹⁰

Recirculated reservoir cooling system

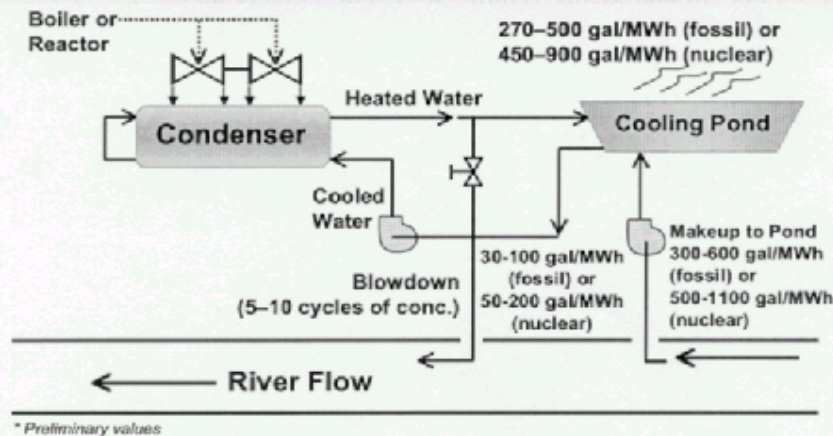

Figure 2-1 Reservoir cooling system

¹⁰ See Harbeck, G. Earl, Jr., The Use of Reservoirs and Lakes for the Dissipation of Heat, Geological Survey Circular 282, U.S. Department of the Interior, 1953, at page 5.

For Lake Colorado City, Texas, Harbeck estimates that 58 % of total heat added is dissipated by evaporation, 25 % was conducted to the air above the reservoir, 3 % was carried away by the evaporated water, and 14 % was radiated to the atmosphere.¹¹

Dissipation of heat added to the reservoir varies with meteorological conditions, particularly wind speed, air temperature, and humidity. Therefore, while the results may be generally applied at other locations, the exact results of studies such as the one conducted at Lake Colorado City should be strictly applied only to the location where the research was conducted. However, a third Harbeck study permits an estimation of the increase in evaporation that would occur in other locations by making adjustments based upon the air temperature and wind speed measured at the nearest weather station.¹²

The following table was prepared using the foregoing study to illustrate the percentage of heat used in evaporation at different locations throughout the United States.

TABLE 2-1 VARIOUS CITIES - EVAPORATION RATES

City	Mean Temperature (°F)	Mean Wind Speed* (mph)	Percent of heat added that is utilized to increase evaporation
Phoenix, Arizona	69.0	3.3	46
Sacramento, Calif.	60.4	6.2	49
Denver, Colorado	49.5	6.7	42
Atlanta, Georgia	61.4	6.6	50
Chicago, Illinois	50.8	7.3	43
Topeka, Kansas	54.9	7.9	49
Syracuse, New York	48.0	7.0	42
Portland, Oregon	52.9	5.4	44
San Antonio, Texas	68.7	6.4	55
Washington, D.C.	57.0	6.8	48
			Avg. = 46.8
*corrected to 2 meter speed			

If 47 % of the heat added to a reservoir is dissipated by evaporation and assuming evaporation takes place at the rate of 1061 BTU per pound of water (the enthalpy of water at a saturation temperature of 57°F), the amount of water evaporated will be approximately 50 gallons per million BTU of heat added to the lake.

¹¹ See FN 4, supra, at page 26.

¹² Harbeck, G.E. Jr., Estimating Forced Evaporation from Cooling Ponds, Journal of the Power Division, Proceedings of the American Society of Civil Engineers, Vol. 90 No. PO 3, October 1964; also see generally FN4, supra.

The dissipation of heat from a lake is entirely a surface phenomenon. Therefore, the amount of surface area available is a critical factor in the use of lakes for cooling. A general rule used by electric generating utilities is that about one acre of lake surface area is required for each megawatt of generating capacity using the lake for cooling.

There is little information available as to the amount of water consumed due to heat that is added to flowing rivers. Although heat dissipation from a river involves some phenomena that are different from those which occur in ponds and reservoirs, this paper will assume that the percentage of heat added to a river, that is dissipated through evaporation, is the same as that for a reservoir. Although this assumption may have a probability of error, it should be adequate for the purpose of this paper until better research on heat dissipation in rivers becomes available.

Wet-Type Cooling Tower Use For Cooling

Wet-type cooling towers dissipate approximately 90 % of their heat load by evaporation. In addition, systems using wet-type cooling towers require an additional continuous replacement of water in order to prevent excess build-up of dissolved solids in the circulating water system due to the loss of water by evaporation. The water that is discharged from the system in this process is termed “blowdown.” The amount of this blowdown varies, depending upon the salt content of the makeup water and the permissible concentration (from considerations of corrosion and scaling) in the circulating water system. For the generalized case, the total water consumption in the tower is equal to $\frac{En}{(n-1)}$ where n is the ratio of the concentration of the water maintained in the cooling tower system to the concentration of the makeup water and E is the amount of water evaporated by the tower. A concentration ratio of 5, which is typical among generating facilities, results in a total water requirement approximately 25% greater than that needed to replace the evaporation loss alone.

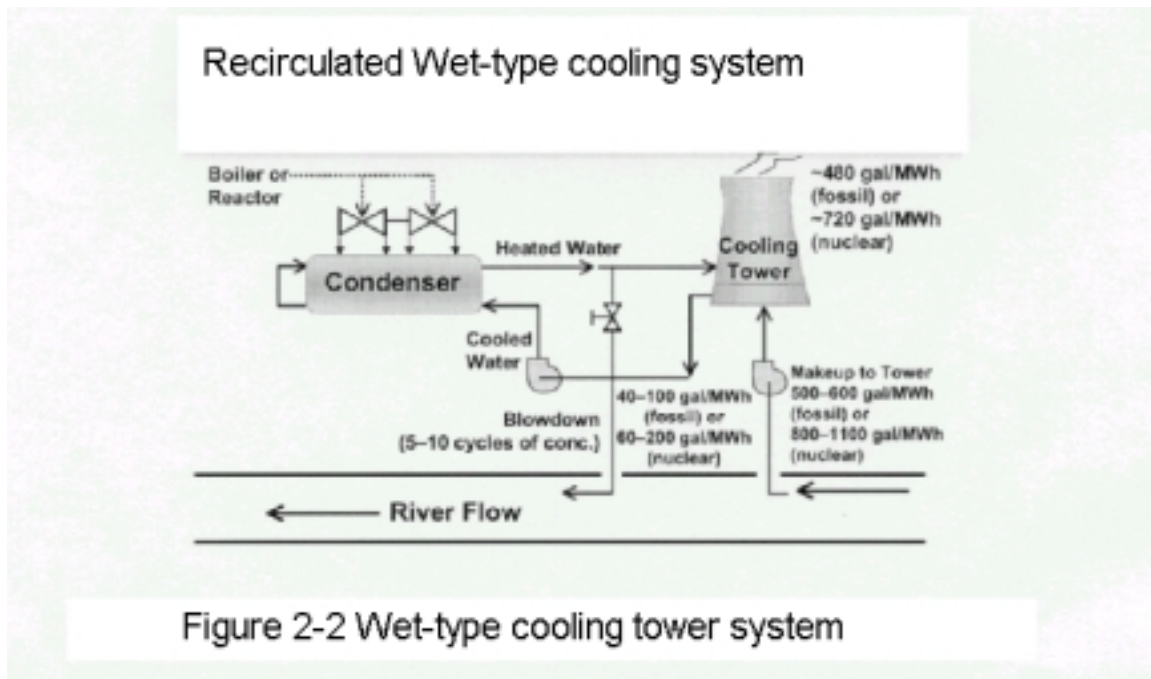

Figure 2-2 Wet-type cooling tower system

Assuming that the typical cooling tower dissipates heat at the rate of 1061 BTU per pound of water evaporated, that 10% of the heat is dissipated by non-evaporative processes, and that makeup is 1.25 times the amount evaporated, the net amount of water required for the typical wet-type cooling tower is approximately 140 gallons per million BTU of heat dissipated.

Dry-Type Cooling Tower (Radiator) Use For Cooling

Dry-type cooling towers are very expensive and infrequently used, though they are becoming more common in desert climates where water supplies are severely constrained. Because the heat is dissipated directly to air by conduction and convection rather than by evaporation as in a wet-type cooling tower, much more air must be moved through the dry-type tower and the available heat transfer surface must be very great. Both of these factors greatly increase the power requirements of these towers, because of the power needs of the fans utilized to move air across the cooling coils. In addition, the minimum cooling temperatures achievable in dry-type towers are limited by the dry-bulb (rather than the wet-bulb) air temperature, which results in higher turbine exhaust temperatures. In the warmer parts of the country this places a severe penalty upon the efficiency and capability of the power plant. Because of their substantially greater energy and capital cost, it is unlikely that dry-type towers will be used to any great extent in this country in the near future. Hence, they are not considered as a factor in determining the water use estimates in this paper.

Recirculated Dry-type cooling system

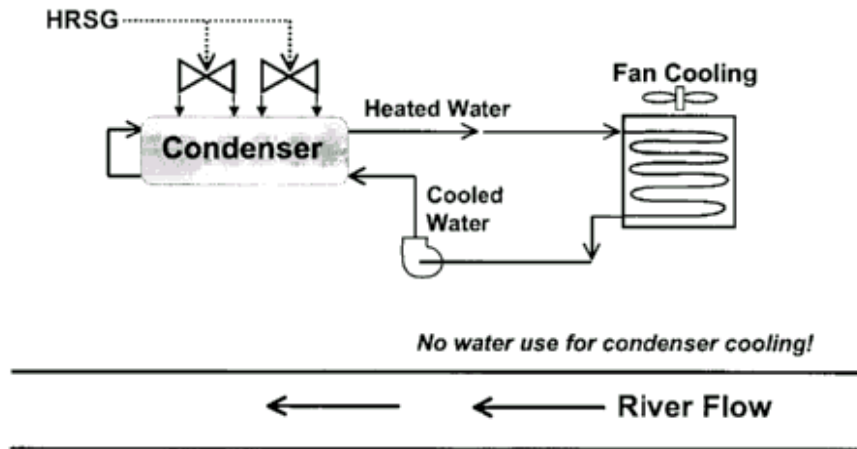

Figure 2-3 Dry-type (radiator) cooling system

B. Determination of Estimating Factors for Total Electric Generation Water Use

The estimated water use for various type of electric generation is listed in Table 2-2. A discussion of the various types follows and the sources and derivations of these water use factors is set forth under this section.

TABLE 2-2 SUMMARY OF WATER USE BY GENERATION TYPE

Type of Generation	Gallons of water evaporated / kWh
Steam Turbine	0.2 – 0.98 Range
Gas Turbine	0.05
Combined Cycle	0.23
Coal Fueled	0.35
Nuclear	0.4 – 0.72 Range
Gasified Fluidized Bed	0.51

Steam Turbine Electric Generating Plants

As has been shown earlier in this report, the bulk of the water consumed by a fossil-fueled electric generating plant is that which is utilized for plant cooling and pollution control. Most other uses are considered to be minimal and can, for planning purposes, be disregarded. Since cooling water need is directly related to plant operation (i.e. that plant does not consume water when it is not operating) water consumption can be estimated when the following factors are known:

- Type of electric generating plant (steam turbine, gas turbine, etc.)
- Fuel type (natural gas, coal, nuclear)
- Type of cooling system used (once-through, cooling tower, radiator)
- Electric production of the plant (how much power will be produced)

By combining the foregoing estimates of water consumption rates with the ranges in heat rejection and circulating water flow, ranges of water consumption by type of generating facility can be estimated as follows:

- (1) For smaller, less efficient fossil-fueled plants and for currently operating nuclear units, the amount of heat rejected can be as high as 7000 BTU/kWh generated and the amount of water required to be circulated through the condenser for the removal of heat is about 50 gallons/kWh generated. The amount of water actually consumed is about 0.41 gallons /kWh in plants located on lakes or rivers and 0.98 gallons/kWh in plants using wet-type cooling towers.
- (2) Large, modern, highly efficient plants will typically reject heat at rates as low as 4000 BTU/kWh generated and will require the circulation of about 30 gallons/kWh generated. The actual water consumed will be as low as 0.20

gallons/kWh in plants located on lakes or rivers and 0.56 gallons/kWh in plants using wet-type cooling towers.

- (3) Most plants operate between the above ranges. The “average” fossil-fueled unit would reject heat at a rate of 5300 BTU/kWh generated and would consume between 0.27 (lake or river) and 0.75 (wet-type tower) gallons/kWh. For purposes of this study, it is assumed that the “average” power plant using once-through cooling will consume water at the rate of 0.35 gallons/kWh and the “average” power plant using a wet-type cooling tower will consume water at the rate of 0.60 gallons/kWh.¹³

Gas Turbine Electric Generating Plants

A natural gas-fueled gas turbine will use much less water for cooling than a natural gas-fueled steam turbine system. The water use factor for a gas turbine with wet NOx control is approximately 0.05 gallons of water evaporated/kWh of electricity produced. The water use factor for a gas turbine with dry type NOx control is negligible.

Combined Cycle Electric Generating Plants

Modern combined cycle electric generating plants generally have two units of gas turbine generation for each unit of steam turbine generation and use natural gas as a fuel. For example, a 300MW capacity combined cycle generating plant will have 200 MW of gas turbine capacity and 100 MW of steam turbine capacity. The gas turbines will consume about the same amount of water that a gas turbine would consume when operating alone or not in combined cycle. The steam turbine will consume about as much water as it would consume when operating alone. But the two systems operating in combined cycle will exhibit a lower water consumption rate than if the total capacity was produced by a steam turbine alone. For example, a 300 MW combined cycle power station using a surface reservoir (once-through) for cooling will have a water consumption factor as follows:

$$(200,000 \text{ kWh})(.05 \text{ gal/kWh}) + (100,000 \text{ kWh})(0.35 \text{ gal/kWh}) = (300,000 \text{ kWh}) (x)$$

$$x = \mathbf{0.15 \text{ gallons/kWh}}$$

If the 300 MW combined cycle power station uses a cooling tower for cooling, the water consumption factor is calculated as follows:

$$(200,000 \text{ kWh})(.05 \text{ gal/kWh}) + (100,000 \text{ kWh})(0.60 \text{ gal/kWh}) = (300,000 \text{ kWh}) (x)$$

¹³ As noted earlier in the report, approximately 60 percent of the heat rejected to a reservoir being used as a source of once-through cooling for a power plant will be dissipated by evaporation of water from the surface of the reservoir. At standard atmospheric conditions, it takes approximately 970 BTUs to evaporate one pound of water. Therefore, in order to determine the amount of water evaporated, the amount of heat rejected to the reservoir as measured in BTUs should be multiplied by 60 percent and the product divided by 970 to determine the pounds of water that were caused to be evaporated by the addition of heat to the reservoir. The pounds of water can be converted to gallons by dividing pounds by 8.32 (i.e. the number of pounds in a gallon of water at standard atmospheric conditions).

x = **0.23 gallons/kWh**

Coal-Fueled Electric Generating Plants

Because of the various pollution control devices used in a coal-fueled generating plant, the water use factor is higher. From water use measurements for various coal-fueled electric generating plants, the following water use factors are recommended:

- A coal-fueled plant cooled by a cooling tower -- 0.60 gallons of water consumed for each kWh of electric power produced.
- A coal-fueled plant cooled by once-through circulation from a surface reservoir -- 0.35 gallons of water consumed for each kWh of power produced.

Nuclear-Fueled Electric Generating Plants

From water use measurements taken at nuclear-fueled electric generation facilities cooled by once-through circulation within a closed pond system, water use can be estimated as 0.58 gallons per kWh. The Electric Power Research Institute (EPRI)¹⁴ derived the water consumption estimates for nuclear-fueled electric generation facilities shown below in Table 2-3.

TABLE 2-3 NUCLEAR PLANT WATER CONSUMPTION

Plant and Cooling System Type	Typical Water Consumption (gal/kWh)
Nuclear steam, once-through cooling	~0.400
Nuclear steam, pond cooling	0.400 – 0.720
Nuclear steam, cooling towers	0.720

Gasified Fluidized Bed Generating Plants

Gasified fluidized bed generating units are still a relatively new technology. The number of generating units of this type in Texas is nominal. Because of the potential of this technology to minimize the emission of air pollutants from coal fuels, it may be utilized more in the future. The Electric Power Research Institute estimates¹⁵ that the water consumed by a coal/petroleum residuum-fueled combined-cycle generating plant utilizing cooling towers is approximately 0.51 gallons/kWh.

¹⁴ See FN 1, supra, at page viii.

¹⁵ See FN 1, supra, at page 3-7

SECTION III: STATEWIDE ELECTRIC GENERATION PROJECTIONS

Introduction

This section of the study attempts to establish statewide electric generation projections for Texas on a decadal basis that corresponds with the 50-year planning horizon to be utilized by the regional water planning groups during the next 5-year planning cycle (i.e. through 2060). These electric generation projections will be calculated utilizing two different methodologies, so that the results of each methodology can be compared for verification and calibration purposes. A final methodology will then be recommended.

Generally, the two methodologies used are as follows:

1. Derivation of a per capita electric use factor from existing population and total electric use data from the past two decades, and utilization of that per capita factor with the TWDB population projections to project total electric use throughout the 50-year planning horizon; and
2. Derivation of an electric demand growth factor from the electric demand projections developed by the Public Utility Commission of Texas (PUCT), and extrapolation of the factor across the 50-year planning horizon.

Once the total electric demand has been estimated for a given year, then the amount of statewide water consumption by electric generation facilities for that year can be estimated.

Derivation of Electric Demand Growth Rate Using PUCT Generation Projections

Table 3-1 presents data obtained from the PUCT that predicts annual statewide electric generation for the years 2000 through 2009.¹⁶ The table indicates a leveling of the electric generation growth rate at approximately 2% annually. This is a decline of approximately 1% from the electric growth rate experienced in the years 1994 through 1999.

¹⁶ See "2000 Annual Update of Generating Electric Utility Data," Public Utility Commission of Texas, 2001.

TABLE 3-1 PROJECTED GROWTH OF TOTAL ELECTRIC DEMAND FOR TEXAS

Year	Total Generation (GWh)	Growth Rate (GWh)
2000	337,582	0.7
2001	340,142	0.8
2002	350,129	2.9
2003	357,471	2.1
2004	366,511	2.5
2005	373,979	2.0
2006	383,482	2.5
2007	391,612	2.1
2008	401,228	2.4
2009	410,415	2.2
Decade Averages	22.45% increase (2000 – 2009)	2.0%

Derivation of Per Capita Electric Demand and Per Capita Demand Growth Rate

Table 3-2 presents statewide population estimates for the years 1981 through 1999¹⁷ and statewide generation estimates from the PUCT for those same years.¹⁸ The fourth column in the table presents the per capita power consumption for each person in the State, which is calculated by dividing statewide electric generation by the statewide population. The result is calculated in average kilowatt-hours used by each person each year and utilized to determine the average statewide per capita growth rate for electric generation demand.

¹⁷ Population information provided by U.S. Census Bureau (years 1981-1993) and Texas State Data Center (1994-1999).

¹⁸ See FN 16, supra.

TABLE 3-2 DERIVATION OF PER CAPITA ELECTRICITY DEMAND GROWTH RATE FACTOR

Year	State Population	State Electric Generation (GWh)	Per Capita Electric Use (kWh/yr)	Per Capita Electric Demand Growth Rate
1981	14,746,318	194,685	13,202	-----
1982	15,331,415	195,753	12,768	-3.40%
1983	15,751,676	194,926	12,375	-3.18%
1984	16,007,086	206,410	12,895	4.03%
1985	16,272,734	208,953	12,841	-0.42%
1986	16,561,113	205,525	12,410	-3.47%
1987	16,621,791	207,698	12,496	0.68%
1988	16,667,022	217,553	13,053	4.27%
1989	16,806,735	221,624	13,187	1.01%
1990	16,986,510	227,387	13,386	1.49%
1991	17,339,904	228,699	13,189	-1.49%
1992	17,650,479	230,659	13,068	-0.93%
1993	17,996,764	240,288	13,352	2.12%
1994	18,378,185	283,679	15,436	*See FN 19
1995	18,723,991	293,307	15,665	1.46%
1996	19,128,261	309,637	16,187	3.23%
1997	19,439,337	319,639	16,443	1.55%
1998	19,759,614	337,363	17,073	3.69%
1999	20,044,141	335,159	16,721	-2.11%
Average	-----	-----	-----	0.50%

The average per capita use for electric generation in Texas for the years 1981 through 1999 indicated an average statewide per capita electric generation demand growth rate of 0.5%.¹⁹

¹⁹ When calculating the growth rate utilizing the data set forth from years 1981 to 1999 in Table 3-2 above, the project team discarded the jump in growth between years 1993 and 1994 as an inaccurate anomaly based upon a change in reporting requirements that led to the generation of the data used between those two years. The information on total electric generation for years 1981 through 1993 were taken from “1996 Statewide Electrical Energy Plan,” Public Utility Commission of Texas, 1996. The information on total electric generation from years 1994 through 1999 were taken from “2000 Annual Update of Generating Electric Utility Data,” FN 16, supra. A review of the data set forth under Table 3-2 indicate that the per capita electric demand growth rate during the 1993-1994 transition between the two sources of data set forth in this footnote is an anomaly resulting from the utilization of the two sources of information rather than an actual, reliable data point.

Comparison of Total Statewide Electric Demand Projections Using PUCT Growth Rate Factor Versus Using Per Capita Electric Demand Growth Rate and TWDB Population Projections

In an attempt to verify the accuracy of the 2% growth rate for total statewide electric demand obtained from the PUCT (see Table 3-1), future electric demand was calculated by extrapolating the 0.5% per capita growth rate into the future and multiplying the product by the TWDB’s population projections over the 50-year planning horizon to obtain annual generation on a decadal basis. Column A of the following table presents the results of this calculation as compared to the PUCT projections, which are presented in Column B through the year 2060.

TABLE 3-3 COMPARISON OF TOTAL STATEWIDE ELECTRIC GENERATION DEMAND PROJECTIONS

Year	<u>Column A</u> Annual generation assuming 0.5% increase in per capita electric demand and TWDB population estimates	<u>Column B</u> Annual generation assuming 2.0% increase in annual generation from PUCT
2010	438,829	418,623
2020	538,019	510,299
2030	641,308	622,052
2040	750,832	758,278
2050	877,157	924,337
2060	1,021,679	1,126,761

The previous table shows remarkably similar results using both test methods for estimating statewide electric generation. There is only a 10 % difference in the 2060 generation estimate. It should also be noted that the United States Department of Energy (USDOE)²⁰ projected a 1.8% annual generation increase for the Electric Reliability Council of Texas (ERCOT) planning region (a large percentage of the State) for the next twenty years, which would yield a statewide generation estimate in general agreement with the other two estimates, considering that portions of the state are not included in the USDOE projections.

Recommendation of Methodologies for Projecting Statewide and Per Capita Electric Demands

Given the results of the test calculations under Table 3-3, the project team recommends the following assumptions and methodologies be used for purposes of this study:

1. Future statewide electric demand for the years 2000 through 2009 is assumed to be the same as the PUCT estimates. Electric demand in the year 2010 should be

²⁰ See “2002 Annual Energy Outlook,” United States Department of Energy, Energy Information Administration, December 21, 2001.

assumed to be the 2009 PUCT number of 410,415 GWh increased by 2% (418,623 GWh). Statewide electric demand in future years should escalate the year 2010 demand by 2% per year, utilizing the 2% average annual electric demand growth rate derived under Table 3-1.

2. Utilize the TWDB population projections from the last approved State Water Plan when projecting population for a given year.
3. Per capita electric use for a given year should be calculated by dividing statewide electric demand for that year (utilizing the 2% extrapolation as set forth under Assumption 1) by the TWDB state population projection, rather than extrapolating the per capita electric demand growth rate derived under Table 3-2.

Statewide Electric Generation Demand Projections

Utilizing the methodology set forth above, projected statewide electric generation demand for the years 2000 through 2060 is presented on a decadal basis in the following table, while the projections for each year during that planning horizon are set forth individually in Appendix B1 of this study.

TABLE 3-4 ANNUAL ELECTIC DEMAND PROJECTIONS

Year	Annual Electric Demand (GWh)
2010	418,623
2020	510,299
2030	622,052
2040	758,278
2050	924,337
2060	1,126,761

Electric generation demand varies by regions for a number of different reasons. For example, significant manufacturing demand is not found in some regions and heavily concentrated in other regions. The areas that do not have the manufacturing electric demand still use the manufactured products and contribute to the demand, even though the demand is only realized in other regions. After an extensive search of various databases, it appears that there are no databases that predict electric demand on a county basis. Further, there do not appear to be any generally acceptable predictive tools that would allow a certain per capita electric demand to be applied to individuals that live in rural areas as compared to those who live in metropolitan areas. For those reasons, the project team chose to project electric demand on a statewide annual generation basis, assume that all generation to meet that electric demand would occur within the state of Texas, develop a methodology to determine the amount of water required on a statewide basis to meet that demand, and then develop a methodology to attempt to allocate that water demand by regional water planning group region and by county.

The types of electric generation facility predicted to supply the generation requirement for each county and each region is addressed in Section V of this study. Section V presents three planning scenarios for estimating statewide generation facility requirements.

SECTION IV: WATER SOURCES CURRENTLY IN USE

The objective of Section IV of this study is to identify water sources that are currently being used by power generation facilities in Texas. The electric generation facilities located in Texas as of the year 2002 have been identified and listed in a spreadsheet entitled “Electric Utility and Independent Power Producer Generating Units in Texas. This spreadsheet is included in Appendix A of this study. Within the spreadsheet, the project team assigned an “estimated water use factor” measured in gallons of water consumed per kilowatt-hour of energy produced to each listed unit using the project team’s industry knowledge. The water use factor selection was based on the use factors presented in Section II of this study. The spreadsheet has a column entitled “Annual Capability at 100% Load Factor”. This column indicates the yearly net electric power as measured in MWh that could be produced by each unit if the unit were operated at peak capability for an entire year. Another spreadsheet in Appendix A3 entitled “Future Water Demand for Steam Electric Generation in Texas by Plant or Unit” indicates the water that would be consumed by the unit if operated at peak capability for a year.

An estimate of the surplus water supplies available at each of the generation facilities currently identified was produced by examining the water plans developed by each Regional Water Planning Group. Each RWPG identified the electric generation water demand of electric generation facilities on a regional and county basis. The year 2000 electric generation water demand was compared to the water demand through the 2060 planning period. All claimed electric generation water demand in excess of the year 2000 claims was determined to be “surplus” water supply in that the claimed water must have been based on an underutilized water contract or on an identified future need that was location specific and based on presumed availability. The spreadsheet can be further used to estimate a current statewide water consumption factor for electric generation. That factor was calculated and used in Section V of this study.

The data presented in the spreadsheet in Appendix A3 entitled “Future Water Demand for Steam Electric Generation in Texas by Plant or Unit” was obtained from several sources including the USDOE’s Energy Information Administration (EIA) and the 2002 State Water Plan.

A list of all cogeneration power generation facilities in Texas was compiled from various sources and is presented in Appendix A4 as “Cogeneration Facilities in Texas”. Although the water use associated with cogeneration facilities was not considered in this report, many newer cogeneration plants have been built with a significant excess over the industrial plant demand with the excess being sold into the electrical grid.

SECTION V: ESTIMATES OF FUTURE WATER USE AND STATEWIDE STEAM ELECTRIC WATER DEMAND PROJECTIONS

The objective of Section V is to estimate the future water use by the electric power generation sector utilizing “high use,” “medium use,” and “low use” scenarios.

There are a variety of factors that will affect the water requirements for electric power generation in the future, as has been pointed out in Section II of this report. If the current trend of using natural gas as a fuel for efficient combined cycle power plants continues, water consumption will be less than would be experienced if future generation is fueled by coal. Coal is not a fuel that is currently compatible with use of gas turbines unless the coal is processed into a low particulate gaseous fuel and that is currently very expensive. The price of various types of fuel (natural gas, coal, etc.) is a major factor in determining which generation technology will be utilized. The initiation of a State or Federal energy policy will affect the fuel choices and resultant water consumption. A State or Federal requirement to utilize wet-type cooling towers for electric generation would have the effect of greatly increasing future water use.

For example, in April 2002, the USEPA published newly proposed regulations under Section 316B of the Clean Water Act covering the entrapment and entrainment of aquatic organisms at power plants. If the proposed regulation is promulgated as published in draft form, future power plants would probably be required to install cooling towers rather than once-through cooling systems.

In Section III of this study, it was estimated that the demand for electric power will increase from 337,582 GWh in 2000 to 1,126,761 GWh in 2060. This is an increase of 3.34 times year 2000 electric demand (or a 234% increase). If the future water use rate by electric generation stays the same as the current rate, the need for water by electric generation will increase by the same 234% by the year 2060. However, there are technologies that can reduce the water consumption of electric generation. Use of some of these technologies will have the effect of increasing the cost of electric power because of capital requirements of water efficient generation, the loss of thermal efficiency, and/or the loss of generation capacity caused by in-plant energy uses necessitated by the water efficient equipment.

In order to establish some parameters that can be used to estimate the water needed for power generation through the year 2060, it was decided to establish three scenarios of water use by electric generation. These scenarios are a “high use” scenario, “medium use” scenario, and a “low use” scenario. All three are discussed in detail below.

TABLE 5-1 ESTIMATED INCREASE IN WATER USE BY 2060

Scenarios	Increase Multiplier over Year 2000
High Use	3.34
*Medium Use	* 2.62
Low Use	1.40

*Recommended: Medium Use

High Use Scenario

Except for the Panhandle, Gulf Coast, and Far West regions of Texas, most of the current electric generation in the State uses once-through cooling from reservoirs for large central station generation. Historically, much of the electric power generated in Texas was generated with natural gas as a fuel. Changes in the Federal laws regarding fuel use, which resulted from the oil embargo of 1973, forced a change in fuel use for electric generation from natural gas to either coal or nuclear fuels. Political sentiment has currently removed the nuclear choice from the list of acceptable fuels for future power generation facilities. Natural gas has been returned to the list of fuel options for electric generation by changes in the Powerplant and Industrial Fuel Use Act of 1978. However, the use of natural gas as a fuel is still constrained by the Federal requirement that all gas-fired generation facilities be capable of switching to coal or another alternate fuel on the call to do so by the Federal government. So all current gas-fired generation must be “coal convertible”. (See Powerplant and Industrial Fuel Use Act, U. S. Code; Title 42; Chapter 92; Subchapter II; Part A; Section 8311 (a)).

A review of Sections I and II of this report shows the water consumption rates inherent in fuel and generation technology selections. Fuel options currently available are oil, natural gas, coal, lignite, and some renewable resources such as wind, solar, and hydroelectric power. For large power producers, the fuel selection is generally limited to natural gas, coal, and lignite. Given the fuel and generation technology options currently available, a “high use” scenario was predicated on future generation being fueled by natural gas, oil, coal, or lignite and the generation being cooled by cooling towers. From the estimating factors outlined in Section II of this report, future generation will consume water at the rate of 0.60 gallons per kilowatt-hour.

Calculation of statewide water consumption by electric generation under a “high use” scenario rests on the following presumptions:

1. Electricity demand will increase by a factor of 3.34 (or 234%) from 2000 to 2060. 2000 generation = X and 2060 generation = 3.34 X (From Section IV);
2. Current generation uses water at a rate of 0.60 gallons/kWh;
3. Future generation will be steam electric powered by fossil-fueled boilers;
4. New generation will be cooled by cooling towers and will consume water at a rate of 0.60 gallons per kWh; and
5. Current generation will continue to operate through 2060.

The factor for estimating 2060 water use as compared to 2000 water use under the “high use” scenario is calculated as follows:

$$\begin{aligned} 2000 \text{ generation} &= X \\ 2060 \text{ generation} &= 3.34X \end{aligned}$$

water use rate for 2000 generation = 0.60 gallons per kilowatt-hour (gal/kWh)

$$\text{water use rate for 2060 generation} = (X)(0.60 \text{ gal/kWh}) + (X)(2.34)(0.60)\text{gal/kWh}$$

$$2000 \text{ generation water use} = (X) (0.60 \text{ gallons per kilowatt-hour})$$

$$2060 \text{ generation water use} = (2.34)(X) (0.60 \text{ gal/kWh}) + (1.00)(X) (0.60 \text{ gal/kWh})$$

$$2060 \text{ generation water use} = 1.404 X + 0.60 X = 2.004X$$

$$2060 \text{ water use divided by 2000 water use} = 2.004X / 0.60 X = 3.34$$

Thus for the high use scenario, water use by electric generation in Texas will increase by a factor of 3.34 times current use by the year 2060 (representing a 234% increase).

Medium Use Scenario

The “**medium use scenario**” presumes that half of the future generation will be fueled by coal and cooled by cooling towers and half will be combined cycle generation fueled by natural gas and cooled by cooling towers. This scenario assumes that none of the current existing generation will be retired or replaced.

As stipulated in the “high use” scenario, 2000 water use is presently at a consumption rate of 0.60 gallons per kWh. From Section II of this report, the water use rate for coal-fired generation cooled by cooling towers is 0.60 gal/kWh. The water use rate for combined cycle generation fueled by natural gas and cooled by cooling towers is 0.23 gal/kWh. Using those presumptions, the 2060 water use under a medium use scenario is calculated as follows:

$$2060 \text{ use} = (1 X)(0.60 \text{ gal/kWh}) + (1.17 X)(0.60 \text{ gal/kWh}) + (1.17 X)(0.23 \text{ gal/kWh})$$

$$2060 \text{ use} = 0.60X + 0.702 X + 0.2691 X = 1.5711X$$

$$2060 \text{ water use divided by 2000 water use} = 1.5711X / 0.60 X = 2.6185$$

Thus, for the medium use scenario, water use by electric generation in Texas will increase by a factor of 2.62 times current use by the year 2060 (representing a 162% increase).

Low Use Scenario

The “**low use scenario**” assumes that all future generation will be fueled by natural gas and will be combined cycle generation operated on once-through circulation cooling from reservoirs. One fourth of the current generation will be retired and replaced with the same type of units assumed for future generation. It is further presumed that the once-through cooling reservoirs are preexisting and that no surface evaporation losses will be

accounted to the electric generation source. As stipulated in the high use scenario, current generation consumes water at the rate of 0.60 gal/kWh. From Section II of this report, gas fired combined cycle generation using once-through cooling will consume water at the rate of 0.15 gal/kWh. Given these presumptions, the water use under the low use scenario for the year 2060 will be calculated as follows:

$$2060 \text{ water use} = (0.75 X)(0.60 \text{ gal/kWh}) + (0.25 X)(0.15 \text{ gal/kWh}) \\ + (2.34X)(0.15 \text{ gal/kWh})$$

$$2060 \text{ water use} = 0.45 X + 0.0375 X + 0.351 X = 0.8385 X$$

$$2060 \text{ water use divided by 2000 water use} = 0.8385 X / 0.60 X = 1.3975$$

For the low use scenario, water use by electric generation in Texas will increase by a factor of approximately 1.40 times current use by the year 2060 (representing a 40% increase).

Adjustments to the Scenarios

The technology exists to control water use by electric generation without limiting the amount of generation. But the control must be accompanied by careful evaluation of the effects of cost on electricity prices. Obviously there are trade-offs. If water is relatively inexpensive and relatively available compared to fuel, there is little reason to require extreme water conservation and thereby assure more expensive electricity.

Many electric generation providers in Texas have surplus water supplies contracted or developed to provide for future generation. This is in conformity with the state goals manifest in Senate Bills 1 and 2 to engage in proper water resource planning before supplies are actually needed for such critical societal functions as the provision of electric power. This contracted or developed, but as yet unused, water will provide the cooling for an undetermined amount of future generation. It is estimated that this currently unused water is adequate for at least thirty-five years of generation growth, according to the calculations set forth herein. The data does not exist in any generally accessible database that would allow the project team to exactly quantify that water reserve. The reserve is hereby noted and provides a “cushion” that should be considered in planning for future water needs for electric generation. This contracted water may be reflected in Regional Water Planning Group data as the source of some specific future water use claims at some locations.

SECTION VI: STEAM ELECTRIC WATER DEMAND ON A REGIONAL AND COUNTY BASIS

Section III of this report derived and recommended annual electric generation demands for the State. Section V utilized those electric generation demand projections along with the water consumption use factors identified for each generation and cooling technology to derive estimates of statewide water use for electric generation and statewide steam-electric water demand projections. The objective of Section VI of this study is to recommend a water supply allocation method for power generation that can be used on a county or regional basis through the year 2060.

Difficulties in Allocating Steam Electric Water Demand on a Regional or County Basis

One of the premises of this study was that electric generation water consumption needed to be determined on a county basis. Electric generation facilities are built in large blocks of generation capacity in order to achieve economies of scale. Currently, generation units are being built in sizes that range from 25 to 200 MW for gas turbines and from 400 to 1300 MW for gas and coal-fired steam turbine units. A power generation facility is located where there is fuel, water, an allowable air quality regime, and access to electric transmission facilities. Areas that do not have adequate resources for electric generation will be supplied by electricity generated at a remote site. Where the appropriate mix of these other factors can be found, areas that also have water available for electric generation will have the ability to attract electric generation if desired.

The point of this discussion is that water for electric generation must be provided, but the water management strategy to supply those generation needs will not necessarily be located in every county or even in every Regional Water Planning Group (RWPG) region. This phenomenon may not be unique to the electric generation water demand sector, but is definitely more prevalent than in any other type of water use category maintained by the TWDB. Because electric generation can be transmitted across the grid for great distances to its point of use, the water supplies needed to provide generation for a particular user group do not have to be located even remotely close in proximity to the end user of the electricity that is generated. Thus, it is problematic to derive a methodology for determining water demand projections for power generation on a county or regional basis based upon the electric generation needs of the county or region. Therefore, while the statewide projections developed for both total electric generation and total water needed to supply that generation may be reliable, attempting to predict the individual counties in which those generation facilities may be developed 50 years into the future will be much less reliable.

With that disclaimer in mind, the project team recommends that the TWDB and the regional water planning groups utilize the following methodology and baseline projections for steam electric water planning for both county-specific and region-specific water demand allocation.

Methodology Recommended

To determine steam electric water demand on a county and regional basis, a top down (i.e. use the statewide information as a basis and then derive the regional and county needs) methodology was utilized. Table 6-1 summarizes the statewide generation and water demand based on the medium water use scenario discussed in Section V. The table clearly indicates that the statewide electric demand is projected to increase by two percent annually for a total increase of 234 percent in 2060 over the Year 2000 Baseline Electric Generation Demand figure, while the corresponding water demand would increase by only 162 percent.

TABLE 6-1 STATEWIDE ELECTRICITY AND WATER DEMAND--2000 TO 2060

Year	Electric Demand (GWh)	Percent of Year 2000 Baseline Electric Generation Demand	Increase Factor in Water Use over Year 2000 Based on Medium Use Scenario from Appendix B-1	Calculated Annual Statewide Steam Electric Water Use (Acre feet)	2002 State Water Plan Steam Electric Water Use
2000	337,582	-----	-----	621,601	607,527
2010	418,623	124%	1.166	724,814	831,301
2020	510,299	151%	1.354	841,572	917,994
2030	622,052	184%	1.583	983,900	1,007,424
2040	758,278	225%	1.862	1,157,396	1,057,929
2050	924,337	274%	2.202	1,368,887	1,134,644
2060	1,126,761	334%	2.618	1,626,692	-----

The water demand for each electric generating plant in Texas can be estimated as a percentage of the statewide demand. The county water demands can be summed to give either the regional or the state demand.

For the baseline year 2000, the water demand for each plant is calculated by taking the actual generation by fuel type as documented in the Energy Information Administration (EIA) database and applying the water use factor for the generating units at that plant for each fuel type. The total statewide water demand for the year 2000 can then be determined by adding the calculated demand for the individual units or plants. For the year 2000, the water calculated to be used by each facility was summed to obtain a statewide water demand of 586,664 acre feet, as indicated on the last page of Appendix A3. As indicated earlier in Section VI, statewide estimates for generation and water use are considered to be more reliable than regional and county estimates. Thus the estimated statewide generation (337,582 GWh) and water use (621,601 acre feet) was calculated for the year 2000 and each subsequent year as indicated in Appendix B1 and summarized by decade in Table 6-1. Finally the individual plant water demand estimates were normalized by taking a ratio of calculated statewide total for 2000 as shown in Table 6-1 and the summed statewide plant total from Appendix A3.

Potter County in Region A, which includes both a coal fired and a natural gas fired power plant, will serve as an example to illustrate the methodology used. As found in Appendix A1, Harrington, the coal fired plant, utilizes cooling towers for cooling and has a water use factor of 0.6 gal per kWh, while Nichols, a gas fired plant utilizing cooling towers, has a water use factor of 0.75 gal per kWh. The amount of electricity actually generated at Harrington and Nichols in the year 2000 was 8,028,946 and 993,701 MWh respectively, as indicated in Appendix A2.

So, the following illustrates the water use derivation for the Year 2000 and its corresponding decade at the two power plants:

Harrington Water Use = (Actual electricity generated 8,028.946 GWh) x (water use factor 0.6 gal per kWh) x (Conversion factor of 1,000,000 kWh per GWh times 1 acre foot per 325,851 gallons) x (Ratio of calculated water used statewide from Table 6-1 [621,601 acre feet] to summation of individual plant water estimates statewide for 2000 [586,664 acre feet]); thus

Harrington Water Use for 2000 = 15,664 acre feet as indicated in Appendix A3.

Nichols Water Use = (Actual electricity generated 993.701 GWh) x (water use factor 0.75 gal per kWh) x (Conversion factor of 1,000,000 kWh per GWh times 1 acre foot per 325,851 gallons) x (Ratio of calculated water used statewide from Table 6-1 [621,601 acre feet] to calculated water used by summing individual plant water estimates statewide for 2000 [586,664 acre feet])

Nichols Water Use = 2423 acre feet, as indicated in Appendix A3.

The corresponding water demand for Potter County was then determined to be the sum of the demand for the two plants, or 18,087 acre feet. The corresponding water demand for the region was simply the summation of the demand for the individual counties.

Please note that for most plants on cooling reservoirs, the estimated annual makeup from a river to the cooling reservoir was included in the year 2000 plant water demand as the information was available. In addition, power plants that utilize salt water for cooling were considered to have a fresh water demand. The estimated salt water use is insignificant compared to the water demand for the entire state.

After the baseline year 2000 demand has been determined on a plant-specific basis, the future demand for the years 2010 through 2060 can be determined. The PUCT has estimated the generation demand by year and fuel type for 2000 to 2009²¹ with the data being summarized in Appendix E3. The EIA has estimated the generation demand by year and fuel type for the period of 2001 to 2020²² as found in Appendix E4. Both the PUCT and the EIA projections by fuel type can be trended to determine a rate of future

²¹ See FN 16, supra

²² See FN 20, supra

growth or decline in generation by fuel type. In general, both trends show that coal fired generation will remain relatively unchanged with a slight increase upward. The annual generation produced by nuclear plants in Texas is relatively unchanged as well, but has a slightly downward trend. The generation produced by conventional gas fired steam electric generating plants is projected to decrease over the next twenty years and has a downward trend. The generation produced by combined cycle gas fired steam electric plants is expected to rise sharply over the twenty-year period. Therefore, for the years 2010 and 2020, the estimated water demand was based on the 2000 water demand and was adjusted by a correction factor based on PUCT estimates of electricity generation by fuel type from 2000 to 2009.

Current economics indicate that electric generation from coal fired and nuclear steam turbines will operate at or near their full capability, which is defined as a base-loaded unit. Natural gas fired conventional steam turbine generation will operate more infrequently to meet peak demand. Natural gas fired combined cycle generation will operate somewhere between the base load and peak load extremes.

The decadal water demand for each conventional (nuclear, coal fired and natural gas fired) steam electric plant in the years 2010 and 2020 could then be estimated by assuming that water demand will increase or decrease according to the established generation trend as projected by the PUCT in Appendix E3 and compared to the baseline year 2000. The 2010 and 2020 water demand for coal fired, nuclear, and conventional natural gas fired is calculated by multiplying the demand in the year 2000 by a ratio of the linear trend in the fuel type for the 2010 and 2020 as compared to the trend in the fuel type for the baseline year 2000. The linear curve fit of the trends is provided in Appendix E3. Coal plants in 2010 are expected to generate approximately 1.2 percent more electricity than in 2000. Nuclear plants in 2010 are expected to generate approximately 1.2 percent less electricity than in 2000. Conventional natural gas fired plants in 2010 are expected to generate 17 percent less electricity than the baseline year 2000. For 2020 the generation estimates for coal, nuclear, and conventional natural gas are +2.4, -2.4, and -34 percent respectively when compared to the year 2000 baseline.

This methodology will be illustrated again using Harrington as an example. For 2010 the water demand is estimated as 1.2 percent greater than the 2000 calculated demand of 15,664 acre feet. The demand for 2010 is therefore 15,664 acre feet times 1.012 (1.2 percent) to result in a 2010 demand of 15,854 acre feet. Similarly for 2020 the demand is estimated as 15,664 acre feet times 1.024 (2.4 percent) which results in an estimated 2020 demand of 16,043 acre feet. The same process would be applied to all coal, nuclear, and conventional natural gas fired plants.

The statewide water demand for natural gas fired combined cycle generation may then be estimated by taking the difference between the calculated annual statewide demand as shown in Table 6-1 and the total statewide demand estimated for the conventional steam electric plants, as found on the last page of Appendix A3. The plant-specific combined cycle demand was then assumed to be a percentage of the overall demand attributed to the combined cycle plants statewide. That percentage of the overall combined cycle

demand was determined by comparing the total water demand for a specific combined cycle plant at its maximum capability to the total water demand for all the combined cycle plants in the state at their maximum capability that will be operating during that decade. While this estimate may not accurately reflect the actual load and water demand for a specific unit, it was deemed the most expedient method for developing plant specific data in order to establish county and regional water demand requirements for 2010 and 2020.

The steam turbine for the Mirant plant in Wichita County will illustrate the methodology. For 2010 the estimate for combined cycle water needs is the difference of the statewide total water demand of 724,814 acre feet and the 580,388 acre feet demand estimated to be used by coal, nuclear, and conventional natural gas fired units, which results in 144,426 acre feet remaining for use by combined cycle gas turbine units. The portion of that 144,426 acre feet available to be allocated to the Mirant steam turbine would then be the calculated water usage at a 100 load factor (323 acre feet) for that unit divided by the 2010 water demand at 100 percent load factor for all combined cycle units in the state (180,899 acre feet). The resulting 2010 demand for the Mirant steam turbine would be 258 acre feet, as indicated in Appendix A3.

Please note that the PUCT information for new generating plants as presented in Appendix E was used to determine during which decade a new addition would be made. First, it was assumed that the water demand for all cogeneration facilities would be covered in the statewide manufacturing totals. Next, it was assumed that all of the independent power producing plants indicated in the table would be natural gas fired combined cycle plants and cooled by cooling towers. If the PUCT information indicated that a new plant was projected to be in service by 2010, then the water demand was shown in 2010. If an on-line date was not provided by the PUCT or a projected plant was delayed, it was assumed that the new generation would be added by the year 2020. These calculations were performed only for those counties that had existing or announced generation. All other counties were assumed to have no water demand for steam electric generation.

For the decades 2030 through 2060 the water demand for each plant was projected to increase at the same rate throughout the state regardless of fuel type and generation type. As detailed in the "Medium Use Scenario", it also assumes that none of the units existing today will be retired. While this is an unrealistic assumption, new units will replace existing units and continue to use the water that the existing units currently require. For the sake of simplicity it was assumed that generating units built after 2020 will be constructed at the same sites as those facilities identified in Appendix A3 or at least in the same counties. The individual plant estimates were calculated by multiplying the plant water demand in the year 2020 by a ratio of the future statewide water demand estimates for the year 2030 and the future statewide water demand estimates for 2020. The same procedure was used to estimate the regional and county demand for the years 2040 through 2060. For 2030 through 2060, those decadal estimates increased by the following percentages: 2030 – 16.9 %, 2040 – 17.6%, 2050 - 18.3%, and 2060 - 18.8%.

The method will again be illustrated for the decadal years 2030 through 2060 using Harrington as an example. In 2030 the Harrington demand is estimated as the 2020 demand of 16,043 acre feet multiplied by a ratio of the 2030 and 2020 statewide demands of 983,900 acre feet divided by 841,572 acre feet. The resulting demand for Harrington in 2030 is 18,756 acre feet. A similar process is used to calculate the demands at each plant for 2040, 2050, and 2060. To reiterate, each plant that was recognized to have a water demand in 2020 would see their corresponding water demand increase proportionally from 2030 to 2060. In reality each plant will not see their water demand increase at the same rate, but it was deemed the most expedient method that could be applied for long term planning purposes.

A summary of the estimated regional and county steam electric demand is presented in Table 6-2. It is recommended that each RWPG utilize and protect its regional steam-electric demand total as set forth in the table. Each RWPG should also use the county totals set forth under Table 6-2 as a baseline, and adjust them only based upon better site-specific information available to the county on steam-electric demand locations while protecting their regional total. It may be necessary to move the water out of the region to a location where other water supplies can be gathered together to support a generation facility of the size that achieves the economy of scale best suited to the asset, because high voltage transmission lines and future increases in transmission delivery efficiencies will likely mean that a sizable portion of the electricity demanded by a region could be imported from adjacent regions.

Many of the electric generation suppliers in Texas have water supply contracts that are not being fully utilized at this time. Many of these suppliers will fully utilize the water supplies in the future. Figure 6-1 shows the current water supply for steam electric generation needs as opposed to the steam electric demand per the 2002 State Water Plan (2002 SWP) and the medium water use demand from this study.

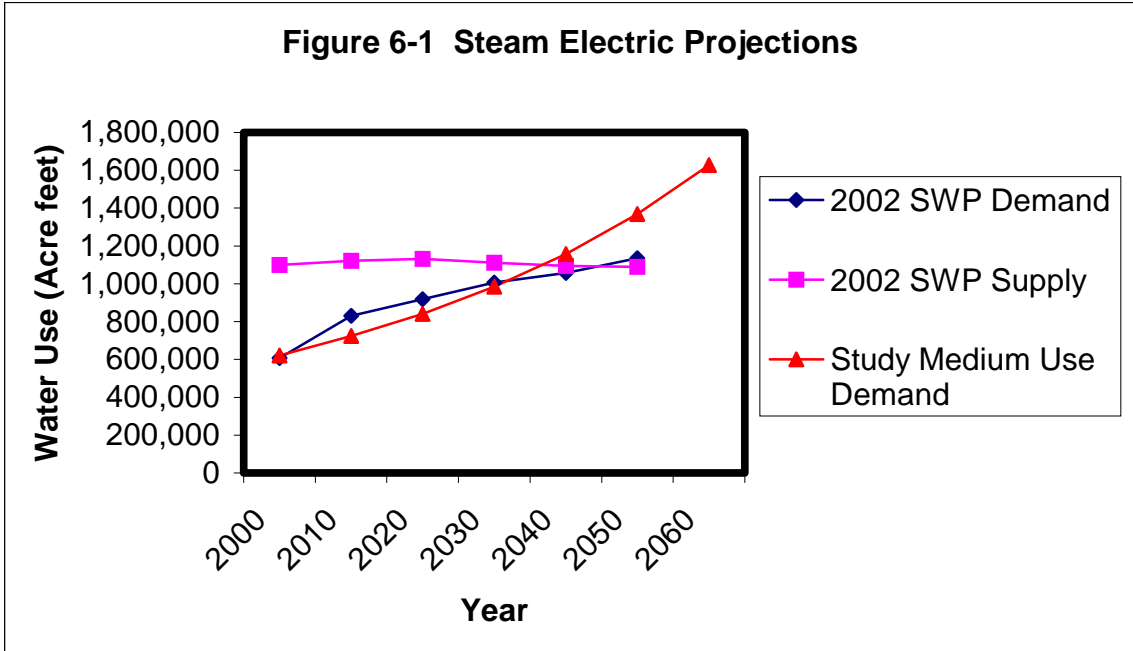

For that reason, this study assumes that additional water supplies for electric generation will not be needed, when the State is viewed as a whole, until around 2037. This does not mean that there will not be areas that are “water short” or “water long”. It means that somewhere in the State there is adequate water to support additional generation through 2037. The 2002 State Water Plan estimated that statewide steam-electric water demand would exceed supply statewide in 2045. Based on the research performed in this study, it is anticipated that statewide demand will actually exceed supply by the end of 2037. Each region could develop a similar supply and demand curve in accordance with the data presented in Table 6-2 and Appendix C to determine at what point additional water is expected to be needed to support future steam electric generation in their region.

SECTION VII: CONCLUSIONS

The literature review and other research performed in the course of this study indicate that this is the most comprehensive effort to date in the state of Texas to derive methodologies for the projection of water demands for the steam-electric water use sector and to apply those methodologies on a statewide, regional, and county-specific basis for the derivation of specific water demand projections. Efforts to check and calibrate the methodologies indicate that they are generally satisfactory, especially when applied to the statewide numbers, and are likely the most accurate and reliable generalized methodologies to be developed on the subject in Texas. However, as set forth in the body of the report, these methodologies and the projections derived from them should serve only as the default baseline numbers when applied on a county or regional basis, and should be adjusted when actual county-specific data is available that indicates clear projections to the contrary.

In carrying this research forward for utilization on a rolling 50-year planning horizon, water planners should note the resources that were deemed by the project team to be the most reliable for predicting future water demand projections for power generation, including information from the PUCT, ERCOT, the EIS and others regarding existing, announced, and projected electric generation, to determine whether such records and data will continue to be collected and to work towards supporting such a continuation if the methodologies developed in this study should continue to be utilized in the future. The labor-intensive effort required to gather and assimilate the plant-specific data for each of the generation facilities in the state might prove implausible but for the availability of such centralized records.

As assumed by the project team at the onset of this research effort, the statewide methodology appears to be much more reliable as a predictive tool than the county-specific methodology. However, the utilization of announced generation facilities, as available, and the trending of electric generation projections by fuel-type and their associated water use factors should prove to be more accurate than other alternatives in the absence of site-specific information.

Water planners will continue to be challenged to accurately predict future power generation water demands in Texas, especially on a localized basis. In large part, this stems from the fact that location of the demand for the water and the location of the end product of that demand, electricity, have little, if any, proximity requirements with modern advances in electric transmission technologies. Other factors unrelated to water supply that drive site selection considerations for future power generation, such as availability of transmission facilities and fuel supplies, emerging generation technologies, and other regulatory considerations such as air quality limitations, may be much more dispositive of the issue than water availability and, indeed, may lend more credence to the assignment by the project team of future generation and related water demand to existing and announced facilities .

Appendix A
Electric Generating Units in Texas

Electric Utility and Independent Power Producer Generating Units in Texas

Region	Company	Plant	County	Unit	Prime Mover	Nameplate (kW)	Fuel Source	Year in Service	Annual Capability at 100% Load Factor (MWhrs)	Cooling Type	Water Source	Water Use Factor (gal/kWhr)
A	Cielo / LPL	Llano Estacado Wind Ranch - White Deer	Carson		WT	80,000	WIND	2002	700,800			0
A	Xcel SPS	Celanese	Gray	1	OT	13,000	OTH	1964	438,000	Cooling Tower	Groundwater	0.98
A		Celanese	Gray	2	ST	37,000	SUB	1979		Cooling Tower	Groundwater	
A	Xcel SPS	Riverview	Hutchinson	6	GT	25,000	NG	1974	219,000			0
A	Xcel SPS	Moore County	Moore	3	ST	49,000	NG	1954	429,240	Cooling Tower	Groundwater	0.98
A	Xcel SPS	Harrington	Potter	1	ST	360,000	SUB	1976	9,460,800	Cooling Tower	Reuse	0.6
A		Harrington	Potter	2	ST	360,000	SUB	1978		Cooling Tower	Reuse	
A		Harrington	Potter	3	ST	360,000	SUB	1980		Cooling Tower	Reuse	
A	Xcel SPS	Nichols	Potter	1	ST	114,000	NG	1960	4,169,760	Cooling Tower	Reuse	0.75
A		Nichols	Potter	2	ST	114,000	NG	1962		Cooling Tower	Reuse	
A		Nichols	Potter	3	ST	248,000	NG	1968		Cooling Tower	Reuse	
B	Panda	Archer Power Partners	Archer		CC	500,000	NG	Delayed	4,380,000			0.23
B	AEP WTU	Lake Pauline	Hardeman	1	ST	20,000	NG	1928	350,400	Once Through	Lake	0.41
B		Lake Pauline	Hardeman	2	ST	20,000	NG	1951		Once Through	Lake	
B	Electra	Electra	Wichita	3	IC	240	NG	1939	37,055			0
B		Electra	Wichita	4	IC	240	NG	1939				
B		Electra	Wichita	5	IC	500	NG	1945				
B		Electra	Wichita	6	IC	500	NG	1947				
B		Electra	Wichita	7	IC	1,500	NG	1953				
B		Electra	Wichita	8	IC	1,250	NG	1959				
B	Mirant	Southern Energy Wichita Falls LP	Wichita	GTA	CT	20,000	NG	1987	175,200			0.05
B		Southern Energy Wichita Falls LP	Wichita	GTB	CT	20,000	NG	1987	175,200			0.05
B		Southern Energy Wichita Falls LP	Wichita	GTC	CT	20,000	NG	1987	175,200			0.05
B		Southern Energy Wichita Falls LP	Wichita	STD	CA	20,000	NG	1987	175,200			0.6
B	AEP WTU	Oklaunion	Wilbarger	1	ST	663,943	SUB	1986	5,816,141	Cooling Tower	Surface	0.6
B	AEP WTU	Vernon	Wilbarger	1	IC	2,460	DFO	1963	98,813			0
B		Vernon	Wilbarger	2	IC	1,360	DFO	1952				
B		Vernon	Wilbarger	3	IC	2,000	DFO	1961				
B		Vernon	Wilbarger	4	IC	4,100	DFO	1968				
B		Vernon	Wilbarger	7	IC	1,360	DFO	1953				
C	TXU	Collin	Collin	1	ST	156,250	NG	1955	1,368,750	Cooling Tower	Groundwater	0.98
C	Garland	Ray Olinger	Collin	1	ST	75,000	NG	1967	3,854,400	Once Through	Lake	0.27
C		Ray Olinger	Collin	2	ST	113,400	NG	1971		Once Through	Lake	
C		Ray Olinger	Collin	3	ST	156,600	NG	1976		Once Through	Lake	
C		Ray Olinger	Collin	4	ST	95,000	NG	2001		Once Through	Lake	
C	Garland	CE Newman	Dallas	1	ST	7,500	NG	1957	845,340	Cooling Tower	Surface	0.75
C		CE Newman	Dallas	2	ST	7,500	NG	1957		Cooling Tower	Surface	
C		CE Newman	Dallas	3	ST	18,750	NG	1960		Cooling Tower	Surface	
C		CE Newman	Dallas	4	ST	18,750	NG	1961		Cooling Tower	Surface	
C		CE Newman	Dallas	5	ST	44,000	NG	1963		Cooling Tower	Surface	
C	TXU	Lake Hubbard	Dallas	1	ST	396,519	NG	1970	8,125,066	Once Through	Lake	0.27
C		Lake Hubbard	Dallas	2	ST	531,000	NG	1973		Once Through	Lake	
C	Exelon	Mountain Creek	Dallas	2	ST	31,213	NG	1945	8,396,381	Once Through	Lake	0.35
C		Mountain Creek	Dallas	3	ST	74,999	NG	1949		Once Through	Lake	
C		Mountain Creek	Dallas	6	ST	135,779	NG	1956		Once Through	Lake	
C		Mountain Creek	Dallas	7	ST	136,000	NG	1958		Once Through	Lake	
C		Mountain Creek	Dallas	8	ST	580,500	NG	1967		Once Through	Lake	
C	TXU	North Lake	Dallas	1	ST	176,800	NG	1959	6,207,380	Once Through	Lake	0.35
C		North Lake	Dallas	2	ST	170,455	NG	1961		Once Through	Lake	
C		North Lake	Dallas	3	ST	361,350	NG	1964		Once Through	Lake	
C	TXU	Parkdale	Dallas	1	ST	79,625	NG	1953	2,983,875	Cooling Tower	Surface, Groundwater	0.75
C		Parkdale	Dallas	2	ST	125,000	NG	1955		Cooling Tower	Surface, Groundwater	
C		Parkdale	Dallas	3	ST	136,000	NG	1957		Cooling Tower	Surface, Groundwater	

Data from US DOE Energy Information Administration's Forms EIA-806A, EIA-806B, EIA-906, and PUCT Report on New Electric Generating Plants in Texas

Electric Utility and Independent Power Producer Generating Units in Texas

Region	Company	Plant	County	Unit	Prime Mover	Nameplate (kW)	Fuel Source	Year in Service	Annual Capability at 100% Load Factor (MWhrs)	Cooling Type	Water Source	Water Use Factor (gal/kWhr)
C	Bio-Energy Partners	DFW Gas Recovery	Denton	GEN1	OT	3,000	LFG	1988	26,280			0
C		DFW Gas Recovery	Denton	GEN2	OT	3,000	LFG	1995	26,280			0
C	Lewisville	Lewisville	Denton	1	HY	2,800	WAT	1992	24,528			0
C	Lewisville	Ray Roberts	Denton	1	HY	1,200	WAT	1992	10,512			0
C	Lewisville	Spencer	Denton	1	ST	12,650	NG	1955	1,523,758	Cooling Tower	Reuse	0.75
C		Spencer	Denton	2	ST	12,650	NG	1955		Cooling Tower	Reuse	
C		Spencer	Denton	3	ST	22,000	NG	1962		Cooling Tower	Reuse	
C		Spencer	Denton	4	ST	61,162	NG	1966		Cooling Tower	Reuse	
C		Spencer	Denton	5	ST	65,483	NG	1973		Cooling Tower	Reuse	
C	ANP	Midlothian Energy Facility	Elis	STK1	CS	289,000	NG	2000	2,531,640			0.23
C		Midlothian Energy Facility	Elis	STK2	CS	289,000	NG	2000	2,531,640			0.23
C		Midlothian Energy Facility	Elis	STK3	CS	289,000	NG	2000	2,531,640			0.23
C		Midlothian Energy Facility	Elis	STK4	CS	289,000	NG	2000	2,531,640			0.23
C		Midlothian Energy Facility	Elis	STK5	CS	289,000	NG	2002	2,531,640			0.23
C		Midlothian Energy Facility	Elis	STK6	CS	289,000	NG	2002	2,531,640			0.23
C	Tractebel	Ennis Tractebel Power Co LP	Elis		CC	350,000	NG	2002	3,066,000		Municipal	0.23
C	Tractebel	Ennis Tractebel Power Co LP	Elis		CC	800,000	NG	2004	7,008,000			0.23
C	TXU	Valley	Fannin	1	ST	198,990	NG	1962	10,297,292	Once Through	Lake	0.27
C		Valley	Fannin	2	ST	580,500	NG	1967		Once Through	Lake	
C		Valley	Fannin	3	ST	396,000	NG	1971		Once Through	Lake	
C	Calpine	Freestone Power Generation LP	Freestone		CC	1,030,000	NG	2002	9,022,900			0.23
C	TXU	Big Brown	Freestone	1	ST	593,400	LIG	1971	10,396,368	Once Through	Lake	0.35
C		Big Brown	Freestone	2	ST	593,400	LIG	1972		Once Through	Lake	
C	USCE	Denison	Grayson	1	HY	35,000	WAT	1945	613,200			0
C		Denison	Grayson	2	HY	35,000	WAT	1949				
C	Whitesboro	Whitesboro	Grayson	1	IC	1,250	NG	1959	34,164			0
C		Whitesboro	Grayson	2	IC	900	NG	1955				
C		Whitesboro	Grayson	3	IC	500	NG	1951				
C		Whitesboro	Grayson	4	IC	1,250	NG	1951				
C	TXU	Trinidad	Henderson	D1	IC	2,000	DFO	1966	35,040			0
C		Trinidad	Henderson	D2	IC	2,000	DFO	1966				
C		Trinidad	Henderson	6	ST	239,360	NG	1965	2,096,794	Once Through	Lake	0.35
C	Duke Energy	Jack Energy Facility	Jack		CC	520,000	NG	delayed	4,555,200			0.23
C	Cobisa / FP&L	Forney Power Plant	Kaufman		CC	1,818,800	NG	2003	15,932,688	Cooling Tower	Reuse	0.23
C	Duke Energy	Kaufman LP Facility	Kaufman		CC	700,000	NG	unknown	6,132,000			0.23
C	Brazos Electric	North Texas	Parker	1	ST	16,500	NG	1958	621,960	Once Through	Lake	0.35
C		North Texas	Parker	2	ST	16,500	NG	1958		Once Through	Lake	
C		North Texas	Parker	3	ST	38,000	NG	1963		Once Through	Lake	
C	Mirant	Mirant	Parker		CC	650,000	NG	delayed	5,694,000			0.23
C	Weatherford	Weatherford	Parker	1	IC	300	DFO	1940	51,334			0
C		Weatherford	Parker	2	IC	300	DFO	1940				
C		Weatherford	Parker	3	IC	300	DFO	1940				
C		Weatherford	Parker	4	IC	840	DFO	1945				
C		Weatherford	Parker	6	IC	1,400	DFO	1948				
C		Weatherford	Parker	7	IC	1,360	DFO	1953				
C		Weatherford	Parker	8	IC	1,360	NG	1953				
C	TXU	Eagle Mountain	Tarrant	1	ST	122,500	NG	1954	6,185,874	Once Through	Lake	0.35
C		Eagle Mountain	Tarrant	2	ST	187,500	NG	1956		Once Through	Lake	
C		Eagle Mountain	Tarrant	3	ST	396,150	NG	1971		Once Through	Lake	
C	Exelon	Handley	Tarrant	1	ST	43,750	NG	1948	12,556,146	Once Through	Lake	0.27
C		Handley	Tarrant	2	ST	74,800	NG	1950		Once Through	Lake	
C		Handley	Tarrant	3	ST	404,800	NG	1963		Once Through	Lake	
C		Handley	Tarrant	4	ST	455,000	NG	1976		Once Through	Lake	
C		Handley	Tarrant	5	ST	455,000	NG	1977		Once Through	Lake	
C	TXU	North Main	Tarrant	4	ST	81,250	NG	1952	711,750	Once Through	River	0.35
C	Tractebel	Wise County Power Co LP	Wise		CC	800,000	NG	2004	7,008,000			0.23

Data from US DOE Energy Information Administration's Forms EIA-806A, EIA-806B, EIA-906, and PUCT Report on New Electric Generating Plants in Texas

Electric Utility and Independent Power Producer Generating Units in Texas

Region	Company	Plant	County	Unit	Prime Mover	Nameplate (kW)	Fuel Source	Year in Service	Annual Capacity at 100% Load Factor (MWhrs)	Cooling Type	Water Source	Water Use Factor (gal/kWhr)
D	AEP SWEPCO	Knox Lee	Gregg	2	ST	30,000	NG	1950	4,018,159	Once Through	Lake	0.35
D		Knox Lee	Gregg	3	ST	30,000	NG	1952		Once Through	Lake	
D		Knox Lee	Gregg	4	ST	75,000	NG	1956		Once Through	Lake	
D		Knox Lee	Gregg	5	ST	323,694	NG	1974		Once Through	Lake	
D	AEP SWEPCO	Pirkey	Harrison	1	ST	660,402	LIG	1985	5,785,122	Once Through	Lake	0.35
D	Entergy / NE TX Coop	Harrison County Power Project	Harrison		CC	570,000	NG	2003	4,993,200			0.23
D	Cobisa	Greenville	Hunt		CC	1,750,000	NG	2006	15,330,000			0.23
D	Greenville	Powerlane	Hunt	ST1	ST	16,500	NG	1966	741,972	Once Through	Lake	0.35
D		Powerlane	Hunt	ST2	ST	25,000	NG	1969		Once Through	Lake	
D		Powerlane	Hunt	ST3	ST	43,200	NG	1977		Once Through	Lake	
D	Panda	Lamar Power Project	Lamar	CTG2	CT	171,700	NG	2000	1,504,092		Municipal	0.05
D		Lamar Power Project	Lamar	CTG1	CT	171,700	NG	2000	1,504,092		Municipal	0.05
D		Lamar Power Project	Lamar	STG1	CA	202,020	NG	2000	1,769,695		Municipal	0.6
D		Lamar Power Project	Lamar	STG2	CA	202,020	NG	2000	1,769,695		Municipal	0.6
D		Lamar Power Project	Lamar	CTG3	CT	171,700	NG	2000	1,504,092		Municipal	0.05
D		Lamar Power Project	Lamar	CTG4	CT	171,700	NG	2000	1,504,092		Municipal	0.05
D	AEP SWEPCO	Wilkes	Marion	1	ST	160,000	NG	1964	7,072,719	Once Through	Lake	0.27
D		Wilkes	Marion	2	ST	323,694	NG	1970		Once Through	Lake	
D		Wilkes	Marion	3	ST	323,694	NG	1971		Once Through	Lake	
D	AEP SWEPCO	Lone Star	Morris	1	ST	40,000	NG	1954	350,400	Once Through	Lake	0.35
D	TXU	River Crest	Red River	1	ST	112,500	NG	1954	985,500	Once Through	Lake	0.35
D	TXU	Monticello	Titus	1	ST	593,400	LIG	1974	17,345,238	Once Through	Lake	0.35
D		Monticello	Titus	2	ST	593,400	LIG	1975		Once Through	Lake	
D		Monticello	Titus	3	ST	793,250	LIG	1978		Once Through	Lake	
D	AEP SWEPCO	Welsh	Titus	1	ST	512,321	SUB	1977	13,463,796	Once Through	Lake	0.35
D		Welsh	Titus	2	ST	512,321	SUB	1980		Once Through	Lake	
D		Welsh	Titus	3	ST	512,321	SUB	1982		Once Through	Lake	
E	LCRA	West Texas Windplant	Culberson	WIND	WT	33,600	WIND	1995	294,336			0
E	National Wind Power	Delaware Mountain Windfarm	Culberson	WIND	WT	30,000	WIND	1999	262,800			0
E	Orion Energy	Orion	Culberson	WIND	WT	175,000	WIND	2003	1,533,000			0
E	ANP	West Texas Energy Facility	El Paso		CC	500,000	NG	delayed	4,380,000			0.23
E	Cielo / El Paso Electric	Huaco Mountain Wind Ranch	El Paso		WT	1,320	WIND	2002	11,563			0
E	El Paso	Copper	El Paso	1	GT	80,550	NG	1980	705,618			0
E	El Paso	Newman	El Paso	CT1	CT	85,000	NG	1975				
E		Newman	El Paso	CT2	CT	85,000	NG	1975				
E		Newman	El Paso	1	ST	81,600	NG	1960	2,438,565	Cooling Tower	Reuse, Groundwater	0.75
E		Newman	El Paso	2	ST	81,600	NG	1963		Cooling Tower	Reuse, Groundwater	
E		Newman	El Paso	3	ST	115,175	NG	1966		Cooling Tower	Reuse, Groundwater	
E		Newman	El Paso	4	CA	120,000	NG	1975	2,540,400	Cooling Tower	Reuse, Groundwater	0.23
E	AEP WTU	Fort Davis	Jeff Davis	1	PV	1,000	SUN	1993	8,760			0
E	AEP - WTU	Fort Davis	Jeff Davis		WT	6,600	WIND	1996	57,816			0
E	AEP WTU	Presidio	Presidio	5	IC	1,136	DFO	1967	19,903			0
E		Presidio	Presidio	6	IC	1,136	DFO	1967				
F	AEP WTU	Oak Creek	Coke	1	ST	75,000	NG	1962	657,000	Once Through	Lake	0.35
F	Coleman	Coleman	Coleman	IC1	IC	1,500	NG	1955	147,694			0
F		Coleman	Coleman	IC2	IC	1,000	NG	1959				
F		Coleman	Coleman	IC3	IC	1,300	NG	1951				
F		Coleman	Coleman	IC4	IC	1,500	NG	1963				
F		Coleman	Coleman	IC5	IC	2,200	NG	1968				
F		Coleman	Coleman	IC6	IC	2,500	NG	1973				
F		Coleman	Coleman	IC7	IC	1,500	NG	1978				
F		Coleman	Coleman	IC8	IC	1,360	NG	1980				

Data from US DOE Energy Information Administration's Forms EIA-806A, EIA-806B, EIA-906, and PUCT Report on New Electric Generating Plants in Texas

Electric Utility and Independent Power Producer Generating Units in Texas

Region	Company	Plant	County	Unit	Prime Mover	Nameplate (kW)	Fuel Source	Year in Service	Annual Capability at 100% Load Factor (MWhrs)	Cooling Type	Water Source	Water Use Factor (gal/kWhr)
F		Coleman	Coleman	IC9	IC	4,000	NG	1986				
F	AEP WTU	Rio Pecos	Crockett	4A	GT	5,000	NG	1998	43,800			0
F		Rio Pecos	Crockett	5	ST	33,000	NG	1959		Cooling Tower	Groundwater	
F		Rio Pecos	Crockett	6	ST	88,958	NG	1969	1,068,440	Cooling Tower	Groundwater	0.75
F	Panda	Odessa-Ector Generating Station	Ector		CT	147,000	NG	2001	1,287,720			0.05
F		Odessa-Ector Generating Station	Ector		CT	147,000	NG	2001	1,287,720			0.05
F		Odessa-Ector Generating Station	Ector		CA	223,000	NG	2001	1,953,480			0.6
F		Odessa-Ector Generating Station	Ector		CT	147,000	NG	2001	1,287,720			0.05
F		Odessa-Ector Generating Station	Ector		CT	147,000	NG	2001	1,287,720			0.05
F		Odessa-Ector Generating Station	Ector		CA	223,000	NG	2001	1,953,480			0.6
F	York Research	Big Spring Wind Power Facility	Howard		WT	40,920	WIND	1999	358,459			0
F	TXU	Morgan Creek	Mitchell	CT1	GT	89,478	NG	1988	4,702,964			0.05
F		Morgan Creek	Mitchell	CT2	GT	89,478	NG	1988				
F		Morgan Creek	Mitchell	CT3	GT	89,478	NG	1988				
F		Morgan Creek	Mitchell	CT4	GT	89,478	NG	1988				
F		Morgan Creek	Mitchell	CT5	GT	89,478	NG	1988				
F		Morgan Creek	Mitchell	CT6	GT	89,478	NG	1988				
F		Morgan Creek	Mitchell	2	ST	18,400	NG	1950	7,247,630	Once Through	Lake	0.35
F		Morgan Creek	Mitchell	3	ST	46,000	NG	1952		Once Through	Lake	
F		Morgan Creek	Mitchell	4	ST	75,000	NG	1954		Once Through	Lake	
F		Morgan Creek	Mitchell	5	ST	170,455	NG	1959		Once Through	Lake	
F		Morgan Creek	Mitchell	6	ST	517,500	NG	1966		Once Through	Lake	
F	AEP	Desert Sky	Pecos		WT	150,000	WIND	2001	1,314,000			0
F	AEP WTU	Fort Stockton	Pecos	2	GT	5,000	NG	1958	43,800			0
F	Cielo	Capital Hill	Pecos		WT	100,000	WIND	2003	876,000			0
F	FP&L	Woodward Mountain Wind Ranch	Pecos		WT	160,000	WIND	2001	1,401,600			0
F	Orion	Indian Mesa Wind Farm	Pecos		WT	82,500	WIND	2001	722,700			0
F	AEP WTU	San Angelo	Tom Green	1	CT	25,000	NG	1965				
F		San Angelo	Tom Green	2	CA	85,000	NG	1966	963,600	Once Through	Lake	0.23
F	FP&L	King Mountain Wind Ranch	Upton		WT	76,000	WIND	2001	665,760			0
F	FP&L	King Mountain Wind Ranch 1	Upton		WT	200,000	WIND	2001	1,752,000			0
F	FP&L	King Mountain Wind Ranch 2	Upton		WT	2,600	WIND	2001	22,776			0
F	FP&L	West Texas Wind Energy LLC - SW Mesa	Upton	01	WT	75,000	WIND	1999	657,000			0
F	TXU Energy / Cielo Wind	Noelke Hill	Upton		WT	240,000	WIND	2003	2,102,400			0
F	TXU	Permian Basin	Ward	CT1	GT	89,478	NG	1988	3,919,136			0.05
F		Permian Basin	Ward	CT2	GT	89,478	NG	1988				
F		Permian Basin	Ward	CT3	GT	89,478	NG	1988				
F		Permian Basin	Ward	CT4	GT	89,478	NG	1990				
F		Permian Basin	Ward	CT5	GT	89,478	NG	1990				
F		Permian Basin	Ward	5	ST	114,954	NG	1958	5,697,977	Cooling Tower	Groundwater	0.56
F		Permian Basin	Ward	6	ST	535,500	NG	1973		Cooling Tower	Groundwater	
F	York Research	Notrees	Winkler		WT	80,000	WIND	delayed	700,800			0
G	Duke	Bell Energy Facility	Bell		CC	520,000	NG	delayed	4,555,200			0.23
G	Mirant	Mirant Texas LP Bosque County Plant	Bosque	GT-1	CT	170,000	NG	2000	1,489,200			0.05
G		Mirant Texas LP Bosque County Plant	Bosque	GT-2	CT	170,000	NG	2000	1,489,200			0.05
G		Mirant Texas LP Bosque County Plant	Bosque	GT-3	CT	170,000	NG	2000	1,489,200			0.05
G		Mirant Texas LP Bosque County Plant	Bosque		CA	100,000	NG	2001	876,000		Brazos River	0.6
G		Mirant Texas LP Bosque County Plant	Bosque		CC	504,000	NG	2001	4,415,040			0.23
G	USCE	Whitney	Bosque	1	HY	15,000	WAT	1953	262,800			0
G		Whitney	Bosque	2	HY	15,000	WAT	1953				
G	Bryan	Atkins	Brazos	3	ST	13,000	NG	1955	1,016,160	Cooling Tower	Groundwater	0.75
G		Atkins	Brazos	4	ST	24,000	NG	1958		Cooling Tower	Groundwater	
G		Atkins	Brazos	5	ST	25,000	NG	1966		Cooling Tower	Groundwater	
G		Atkins	Brazos	6	ST	54,000	NG	1969		Cooling Tower	Groundwater	
G		Atkins	Brazos	7	GT	22,000	NG	1975	192,720			0

Data from US DOE Energy Information Administration's Forms EIA-806A, EIA-806B, EIA-906, and PUCT Report on New Electric Generating Plants in Texas

Electric Utility and Independent Power Producer Generating Units in Texas

Region	Company	Plant	County	Unit	Prime Mover	Nameplate (kW)	Fuel Source	Year in Service	Annual Capability at 100% Load Factor (MWhrs)	Cooling Type	Water Source	Water Use Factor (gal/kWhr)
G	Bryan	Dansby	Brazos	1	ST	105,000	NG	1978	919,800	Once Through	Lake	0.27
G	TMPA	Gibbons Creek	Grimes	1	ST	443,970	SUB	1983	3,889,177	Once Through	Lake	0.35
G	Tenaska	Frontier Generation Station	Grimes	STG1	CA	390,101	NG	2000	3,417,285	Once Through	Lake Livingston	0.6
G		Frontier Generation Station	Grimes	GTG3	CT	183,200	NG	2000	1,604,832			0.05
G		Frontier Generation Station	Grimes	GTG1	CT	183,200	NG	2000	1,604,832			0.05
G		Frontier Generation Station	Grimes	GTG2	CT	183,200	NG	2000	1,604,832			0.05
G	AEP WTU	Paint Creek	Haskell	1	ST	30,000	NG	1953	1,910,950	Once Through	Lake	0.35
G		Paint Creek	Haskell	2	ST	33,000	NG	1955		Once Through	Lake	
G		Paint Creek	Haskell	3	ST	50,000	NG	1959		Once Through	Lake	
G		Paint Creek	Haskell	4	ST	105,145	NG	1971		Once Through	Lake	
G	AES	Wolf Hollow LP	Hood		CC	829,600	NG	2002	7,267,296			0.23
G	TXU	DeCordova	Hood	CT1	GT	89,478	NG	1990	3,135,309			0.05
G		DeCordova	Hood	CT2	GT	89,478	NG	1990				
G		DeCordova	Hood	CT3	GT	89,478	NG	1990				
G		DeCordova	Hood	CT4	GT	89,478	NG	1990				
G		DeCordova	Hood	1	ST	799,200	NG	1975	7,000,992	Once Through	Lake	0.2
G	AEP WTU	Fort Phantom	Jones	1	ST	146,460	NG	1974	2,954,941	Once Through	Lake	0.35
G		Fort Phantom	Jones	2	ST	190,862	NG	1977		Once Through	Lake	
G	Reliant	Limestone	Limestone	1	ST	813,400	LIG	1985	14,250,768	Cooling Tower	Surface	0.6
G		Limestone	Limestone	2	ST	813,400	LIG	1986		Cooling Tower	Surface	
G	TXU	Lake Creek	McLennan	D1	IC	2,000	DFO	1966	52,560			0
G		Lake Creek	McLennan	D2	IC	2,000	DFO	1966				
G		Lake Creek	McLennan	D3	IC	2,000	DFO	1966				
G		Lake Creek	McLennan	ST1	ST	79,625	NG	1953	2,764,875	Once Through	Lake	0.35
G		Lake Creek	McLennan	ST2	ST	236,000	NG	1959		Once Through	Lake	
G	TXU	Tradinghouse	McLennan	1	ST	580,500	NG	1970	12,086,172	Once Through	Lake	0.2
G		Tradinghouse	McLennan	2	ST	799,200	NG	1972		Once Through	Lake	
G	TXU	Sandow	Milam	4	ST	590,640	LIG	1981	5,174,006	Once Through	Lake	0.35
G	AEP	Trent Mesa	Nolan		WT	150,000	WIND	2001	1,314,000			0
G	Enron	Enron Wind	Nolan		WT	400,000	WIND	delayed	3,504,000			0
G	TXU	Encogen One	Nolan	GT01	CT	33,250	NG	1989	291,270			0.05
G		Encogen One	Nolan	GT02	CT	72,760	NG	1989	637,378			0.05
G		Encogen One	Nolan	GT03	CT	72,760	NG	1989	637,378			0.05
G		Encogen One	Nolan	STG1	CA	87,200	NG	1989	763,872			0.6
G	BRA	Morris Sheppard	Palo Pinto	1	HY	12,500	WAT	1942	219,000			0
G		Morris Sheppard	Palo Pinto	2	HY	12,500	WAT	1942				
G	Brazos Electric	RW Miller	Palo Pinto	1	ST	66,000	NG	1968	3,206,160	Once Through	Lake	0.27
G		RW Miller	Palo Pinto	2	ST	100,000	NG	1972		Once Through	Lake	
G		RW Miller	Palo Pinto	3	ST	200,000	NG	1975		Once Through	Lake	
G		RW Miller	Palo Pinto	4	GT	118,818	NG	1994	2,081,691			0.05
G		RW Miller	Palo Pinto	5	GT	118,818	NG	1994				
G	TNM	TNP One	Robertson	1	ST	174,800	LIG	1990	3,058,992	Cooling Tower	Groundwater	0.6
G		TNP One	Robertson	2	ST	174,800	LIG	1991		Cooling Tower	Groundwater	
G	TXU	Comanche Peak	Somervell	1	ST	1,215,000	NUC	1990	21,286,800	Once Through	Lake	0.58
G		Comanche Peak	Somervell	2	ST	1,215,000	NUC	1993		Once Through	Lake	0.58
G	AEP WTU	Abilene	Taylor	4	ST	15,000	NG	1949	131,400	Cooling Tower	Surface	0.98
G	TXU	Graham	Young	1	ST	247,775	NG	1960	5,560,629	Once Through	Lake	0.35
G		Graham	Young	2	ST	387,000	NG	1969		Once Through	Lake	
H	Reliant Energy Renewables	Coastal Plains	Brazoria		OT	5,432	LFG	2002	47,584			0
H	Energy Developments, Inc	Alta Loma	Chambers		OT	5,000	LFG	unknown	43,800			0
H	Reliant	Cedar Bayou	Chambers	1	ST	765,000	NG	1970	20,104,200	Once Through	Salt	0.2
H		Cedar Bayou	Chambers	2	ST	765,000	NG	1972		Once Through	Salt	
H		Cedar Bayou	Chambers	3	ST	765,000	NG	1974		Once Through	Salt	
H	Avista / NRG Energy	Brazos Valley Generating Facility	Fort Bend		CC	800,000	NG	2003	7,008,000			0.23
H	Reliant	WA Parish	Fort Bend	GT1	GT	16,320	NG	1967	142,963			0

Data from US DOE Energy Information Administration's Forms EIA-806A, EIA-806B, EIA-906, and PUCT Report on New Electric Generating Plants in Texas

Electric Utility and Independent Power Producer Generating Units in Texas

Region	Company	Plant	County	Unit	Prime Mover	Nameplate (kW)	Fuel Source	Year in Service	Annual Capability at 100% Load Factor (MWhrs)	Cooling Type	Water Source	Water Use Factor (gal/kWhr)
H		WA Parish	Fort Bend	1	ST	187,850	NG	1958	10,997,304	Once Through	Lake	0.27
H		WA Parish	Fort Bend	2	ST	187,850	NG	1958		Once Through	Lake	
H		WA Parish	Fort Bend	3	ST	299,200	NG	1961		Once Through	Lake	
H		WA Parish	Fort Bend	4	ST	580,500	NG	1968		Once Through	Lake	
H		WA Parish	Fort Bend	5	ST	734,100	SUB	1977	12,861,432	Once Through	Lake	0.35
H		WA Parish	Fort Bend	6	ST	734,100	SUB	1978		Once Through	Lake	
H		WA Parish	Fort Bend	7	ST	614,600	SUB	1980	10,767,792	Cooling Tower	Surface	0.6
H		WA Parish	Fort Bend	8	ST	614,600	SUB	1982		Cooling Tower	Surface	
H	Reliant	PH Robinson	Galveston	1	ST	484,500	NG	1966	20,275,020	Once Through	Salt	0.2
H		PH Robinson	Galveston	2	ST	484,500	NG	1967		Once Through	Salt	
H		PH Robinson	Galveston	3	ST	580,500	NG	1968		Once Through	Salt	
H		PH Robinson	Galveston	4	ST	765,000	NG	1973		Once Through	Salt	
H	ANP	Harris Energy Facility	Harris		CC	2,200,000	NG	delayed	19,272,000			0.23
H	Energy Developments, Inc	Whispering Pines	Harris		OT	2,700	LFG	unknown	23,652			0
H	Exelon	LaPorte Generating Station	Harris		GT	40,000	NG	2001	350,400			0.05
H		LaPorte Generating Station	Harris		GT	40,000	NG	2001	350,400			0.05
H		LaPorte Generating Station	Harris		GT	40,000	NG	2001	350,400			0.05
H		LaPorte Generating Station	Harris		GT	40,000	NG	2001	350,400			0.05
H	Reliant	Deepwater	Harris	7	ST	187,850	NG	1955	1,645,566	Once Through	Salt	0.35
H	Reliant	Greens Bayou	Harris	5	ST	446,400	NG	1973	3,910,464	Cooling Tower	Surface	0.56
H		Greens Bayou	Harris	73	GT	72,000	NG	1976	3,784,320			0
H		Greens Bayou	Harris	74	GT	72,000	NG	1976				
H		Greens Bayou	Harris	81	GT	72,000	NG	1976				
H		Greens Bayou	Harris	82	GT	72,000	NG	1976				
H		Greens Bayou	Harris	83	GT	72,000	NG	1976				
H		Greens Bayou	Harris	84	GT	72,000	NG	1976				
H	Reliant	Hiram Clark	Harris	GT1	GT	16,000	NG	1968	840,960		Groundwater	0
H		Hiram Clark	Harris	GT2	GT	16,000	NG	1968				
H		Hiram Clark	Harris	GT3	GT	16,000	NG	1968				
H		Hiram Clark	Harris	GT4	GT	16,000	NG	1968				
H		Hiram Clark	Harris	5	GT	16,000	NG	1968				
H		Hiram Clark	Harris	6	GT	16,000	NG	1968				
H	Reliant	Sam Bertron	Harris	GT1	GT	32,640	NG	1967	571,853			0
H		Sam Bertron	Harris	GT2	GT	16,320	NG	1967				
H		Sam Bertron	Harris	ST1	ST	187,850	NG	1958	7,238,388	Once Through	Salt	0.27
H		Sam Bertron	Harris	ST2	ST	187,850	NG	1956		Once Through	Salt	
H		Sam Bertron	Harris	3	ST	225,300	NG	1959		Once Through	Salt	
H		Sam Bertron	Harris	4	ST	225,300	NG	1960		Once Through	Salt	
H		Sam Bertron	Harris	G1	GT	16,320	NG	1967				
H	Reliant	San Jacinto SES	Harris	SJS1	GT	88,200	NG	1995	1,545,264			0.05
H		San Jacinto SES	Harris	SJS2	GT	88,200	NG	1995				
H	Reliant	TH Wharton	Harris	2	ST	247,800	NG	1960	2,170,728	Cooling Tower	Groundwater	0.75
H		TH Wharton	Harris	3	CA	113,100	WH	1974	5,671,224	Cooling Tower	Groundwater	0.23
H		TH Wharton	Harris	31	CT	51,300	NG	1972				
H		TH Wharton	Harris	32	CT	51,300	NG	1972				
H		TH Wharton	Harris	33	CT	51,300	NG	1972				
H		TH Wharton	Harris	34	CT	51,300	NG	1972				
H		TH Wharton	Harris	4	CA	113,100	WH	1974				
H		TH Wharton	Harris	41	CT	51,300	NG	1972		Cooling Tower	Groundwater	
H		TH Wharton	Harris	42	CT	51,300	NG	1972				
H		TH Wharton	Harris	43	CT	56,700	NG	1974				
H		TH Wharton	Harris	44	CT	56,700	NG	1974				
H		TH Wharton	Harris	51	GT	85,000	NG	1975	4,610,563			0
H		TH Wharton	Harris	52	GT	85,000	NG	1975				
H		TH Wharton	Harris	53	GT	85,000	NG	1975				
H		TH Wharton	Harris	54	GT	85,000	NG	1975				
H		TH Wharton	Harris	55	GT	85,000	NG	1975				

Data from US DOE Energy Information Administration's Forms EIA-806A, EIA-806B, EIA-906, and PUCT Report on New Electric Generating Plants in Texas

Electric Utility and Independent Power Producer Generating Units in Texas

Region	Company	Plant	County	Unit	Prime Mover	Nameplate (kW)	Fuel Source	Year in Service	Annual Capability at 100% Load Factor (MWhrs)	Cooling Type	Water Source	Water Use Factor (gal/KWhr)
H		TH Wharton	Harris	56	GT	85,000	NG	1975				
H		TH Wharton	Harris	GT1	GT	16,320	NG	1967				
H	Reliant	Webster	Harris	GT1	GT	16,320	NG	1967	142,963			0
H		Webster	Harris	3	ST	410,040	NG	1965	3,591,950	Once Through	Salt	0.27
H	Reliant Energy Renewables	Alascosita LP	Harris		OT	5,432	LFG	2003	47,584			0
H	Reliant Energy Renewables	Baytown	Harris		OT	5,432	LFG	2003	47,584			0
H	Reliant Energy Renewables	Blue Bonnet	Harris		OT	2,038	LFG	2003	17,853			0
H	HNG	Dayton Storage Co	Liberty		OT	240,000	OTH	unknown	2,102,400			0
H	Reliant Energy Renewables	Security	Liberty		OT	4,074	LFG	2003	35,688			0
H	Sempra	Cedar Bluff Power Project	Liberty		CC	600,000	NG	2005	5,256,000			0.23
H	Entergy Gulf States	Lewis Creek	Montgomery	1	ST	271,400	NG	1970	4,754,928	Once Through	Lake	0.27
H		Lewis Creek	Montgomery	2	ST	271,400	NG	1971		Once Through	Lake	
H	Reliant Energy Renewables	Conroe	Montgomery		OT	3,057	LFG	2003	26,779			0
H	Sempra	Montgomery County Energy Project	Montgomery		CC	600,000	NG	2006	5,256,000			0.23
H	Warren	Warren Peaking Power Facility	Montgomery		CC	373,000	NG	unknown	3,267,480			0.23
I	Newport	Palestine Power Project	Anderson		CC	1,600,000	NG	delayed	14,016,000			0.23
I	TXU	Stryker Creek	Cherokee	D1	IC	2,000	DFO	1966	87,600			0
I		Stryker Creek	Cherokee	D2	IC	2,000	DFO	1966				
I		Stryker Creek	Cherokee	D3	IC	2,000	DFO	1966				
I		Stryker Creek	Cherokee	D4	IC	2,000	DFO	1966				
I		Stryker Creek	Cherokee	D5	IC	2,000	DFO	1966				
I		Stryker Creek	Cherokee	ST1	ST	176,800	NG	1958	6,162,485	Once Through	Lake	0.35
I		Stryker Creek	Cherokee	ST2	ST	526,680	NG	1965		Once Through	Lake	
I	USCE	Robert D Willis	Jasper	1	HY	3,600	WAT	1989	63,072			0
I		Robert D Willis	Jasper	2	HY	3,600	WAT	1989				
I	USCE	Sam Rayburn	Jasper	1	HY	26,000	WAT	1965	455,520			0
I		Sam Rayburn	Jasper	2	HY	26,000	WAT	1965				
I	Calpine	Amelia Energy Center	Jefferson		CC	900,000	NG	delayed	7,884,000			0.23
I	Port of Port Arthur	Sabine Power	Jefferson		CC	1,000,000	NG	delayed	8,760,000			0.23
I	Steag Power	Steme Electric Generating Facility	Nacogdoches		CC	978,000	NG	2006	8,567,280		Angelina River	0.23
I	Entergy Gulf States	Toledo Bend	Newton	1	HY	40,500	WAT	1969	709,560			0
I		Toledo Bend	Newton	2	HY	40,500	WAT	1969				
I	Hartburg	Hartburg Power LP	Newton		CC	800,000	NG	delayed	7,008,000			0.23
I	Intergen	Cottonwood Energy Project	Newton		CC	1,200,000	NG	2003	10,512,000			0.23
I	Entergy Gulf States	Sabine	Orange	1	ST	239,400	NG	1962	17,968,512	Once Through	Salt	0.27
I		Sabine	Orange	2	ST	239,400	NG	1962		Once Through	Salt	
I		Sabine	Orange	3	ST	473,400	NG	1962		Once Through	Salt	
I		Sabine	Orange	4	ST	591,600	NG	1974		Once Through	Salt	
I		Sabine	Orange	5	ST	507,400	NG	1979		Once Through	Salt	
I	TXU	Martin Lake	Rusk	1	ST	793,250	LIG	1977	20,846,610	Once Through	Lake	0.35
I		Martin Lake	Rusk	2	ST	793,250	LIG	1978		Once Through	Lake	
I		Martin Lake	Rusk	3	ST	793,250	LIG	1979		Once Through	Lake	
I	Tenaska	Gateway Generating Station	Rusk		CT	179,000	NG	2001	1,568,040		Toledo Bend	0.05
I		Gateway Generating Station	Rusk		CT	179,000	NG	2001	1,568,040		Toledo Bend	0.05
I		Gateway Generating Station	Rusk		CT	179,000	NG	2001	1,568,040		Toledo Bend	0.05
I		Gateway Generating Station	Rusk		CA	400,000	NG	2001	3,504,000		Toledo Bend	0.6
J	IBWC	Amistad	Val Verde	1	HY	33,000	WAT	1983	578,160			0
J		Amistad	Val Verde	2	HY	33,000	WAT	1983				
K	FP&L	Bastrop Energy Center	Bastrop		CC	540,000	NG	2002	4,730,400			0.23
K	Gentex / Calpine	Lost Pines I Power Project	Bastrop		CT	195,500	NG	2001	1,712,580			0.05
K		Lost Pines I Power Project	Bastrop		CT	195,500	NG	2001	1,712,580			0.05

Data from US DOE Energy Information Administration's Forms EIA-806A, EIA-806B, EIA-906, and PUCT Report on New Electric Generating Plants in Texas

Electric Utility and Independent Power Producer Generating Units in Texas

Region	Company	Plant	County	Unit	Prime Mover	Nameplate (kW)	Fuel Source	Year in Service	Annual Capability at 100% Load Factor (MWhrs)	Cooling Type	Water Source	Water Use Factor (gal/kWhr)
K		Lost Pines I Power Project	Bastrop		CA	199,400	NG	2001	1,746,744			0.6
K	LCRA	Sim Gideon	Bastrop	1	ST	144,000	NG	1965	5,597,640	Once Through	Lake	0.27
K		Sim Gideon	Bastrop	2	ST	144,000	NG	1968		Once Through	Lake	
K		Sim Gideon	Bastrop	3	ST	351,000	NG	1972		Once Through	Lake	
K	LCRA	Buchanan	Burnet	1	HY	18,300	WAT	1938	419,166			0
K		Buchanan	Burnet	2	HY	18,300	WAT	1938				
K		Buchanan	Burnet	3	HY	11,250	WAT	1938				
K	LCRA	Granite Shoals	Burnet	1	HY	22,500	WAT	1951	394,200			0
K		Granite Shoals	Burnet	2	HY	22,500	WAT	1951				
K	LCRA	Inks	Burnet	1	HY	15,000	WAT	1938	131,400			0
K	LCRA	Marble Falls	Burnet	1	HY	15,000	WAT	1951	262,800			0
K		Marble Falls	Burnet	2	HY	15,000	WAT	1951				
K	LCRA	Fayette	Fayette	1	ST	615,000	SUB	1979	14,804,400	Once Through	Lake	0.35
K		Fayette	Fayette	2	ST	615,000	SUB	1980		Once Through	Lake	
K		Fayette	Fayette	3	ST	460,000	SUB	1988		Once Through	Lake	
K	LCRA	Thomas C Ferguson	Llano	1	ST	446,000	NG	1974	3,906,960	Once Through	Lake	0.27
K	Ridge Energy Storage	Markham Energy Storage Center	Matagorda		OT	270,000	OTH	2004	2,365,200			0
K	Rekant	STP	Matagorda	1	ST	1,354,320	NUC	1988	23,727,686	Once Through	Lake	0.58
K		STP	Matagorda	2	ST	1,354,320	NUC	1989		Once Through	Lake	0.58
K	LCRA	Austin	Travis	1	HY	8,068	WAT	1941	141,351			0
K		Austin	Travis	2	HY	8,068	WAT	1941				
K	Austin	Decker	Travis	GT1	GT	51,570	NG	1988	1,807,013			0.05
K		Decker	Travis	GT2	GT	51,570	NG	1988				
K		Decker	Travis	GT3	GT	51,570	NG	1988				
K		Decker	Travis	GT4	GT	51,570	NG	1988				
K		Decker	Travis	PV3	PV	300	SUN	1987	2,628			0
K		Decker	Travis	1	ST	321,000	NG	1971	6,359,760	Once Through	Lake	0.27
K		Decker	Travis	2	ST	405,000	NG	1978		Once Through	Lake	
K	Austin	Holly	Travis	1	ST	100,000	NG	1960	4,888,080	Once Through	Lake	0.35
K		Holly	Travis	2	ST	100,000	NG	1964		Once Through	Lake	
K		Holly	Travis	3	ST	165,000	NG	1967		Once Through	Lake	
K		Holly	Travis	4	ST	193,000	NG	1974		Once Through	Lake	
K	Austin	Sand Hill	Travis	1	GT	60,500	NG	2001	2,119,920			0.05
K		Sand Hill	Travis	2	GT	60,500	NG	2001				
K		Sand Hill	Travis	3	GT	60,500	NG	2001				
K		Sand Hill	Travis	4	GT	60,500	NG	2001				
K	Austin Energy	Sand Hill	Travis		CC	300,000	NG	2003	2,628,000	Cooling Tower	Reuse	0.23
K		Sand Hill	Travis		CC	250,000	NG	2007	2,190,000			0.23
K	Ecogas	Ecogas	Travis		OT	5,000	LFG	unknown	43,800			0
K	LCRA	Marshall Ford	Travis	1	HY	34,000	WAT	1941	898,294			0
K		Marshall Ford	Travis	2	HY	34,545	WAT	1941				
K		Marshall Ford	Travis	3	HY	34,000	WAT	1941				
K	AEP	Newgulf	Wharton	GEN1	CT	78,750	NG	1984	689,850			0.05
K		Newgulf	Wharton	GEN2	CA	12,500	NG	1988	109,500			0.6
L	San Miguel	San Miguel	Atascosa	1	ST	410,000	LIG	1982	3,591,600	Cooling Tower	Groundwater	0.6
L	CPS San Antonio	A Von Rosenberg	Bexar	1	CT	174,690	NG	2000				
L		A Von Rosenberg	Bexar	2	CT	174,690	NG	2000				
L		A Von Rosenberg	Bexar	3	CA	200,250	NG	2000	4,814,759	Once Through	Reuse	0.15
L	CPS San Antonio	JK Spruce	Bexar	1	ST	546,000	SUB	1992	4,782,960	Once Through	Reuse	0.35
L	CPS San Antonio	JT Deely	Bexar	1	ST	446,000	SUB	1977	7,813,920	Once Through	Reuse	0.35
L		JT Deely	Bexar	2	ST	446,000	SUB	1978		Once Through	Reuse	
L	CPS San Antonio	Leon Creek	Bexar	3	ST	75,000	NG	1953	1,655,640	Cooling Tower	Groundwater	0.75
L		Leon Creek	Bexar	4	ST	114,000	NG	1959		Cooling Tower	Groundwater	
L	CPS San Antonio	Mission Road	Bexar	3	ST	114,000	NG	1958	998,640	Cooling Tower	Groundwater	0.75
L	CPS San Antonio	OW Summers	Bexar	1	ST	446,000	NG	1972	7,813,920	Once Through	Reuse	0.27

Data from US DOE Energy Information Administration's Forms EIA-806A, EIA-806B, EIA-906, and PUCT Report on New Electric Generating Plants in Texas

Electric Utility and Independent Power Producer Generating Units in Texas

Region	Company	Plant	County	Unit	Prime Mover	Nameplate (kW)	Fuel Source	Year in Service	Annual Capability at 100% Load Factor (MWhrs)	Cooling Type	Water Source	Water Use Factor (gal/kWhr)
L		OW Summers	Bexar	2	ST	446,000	NG	1974		Once Through	Reuse	
L		OW Summers	Bexar	A	IC	2,500	DFO	1974	87,600	Once Through	Reuse	0
L		OW Summers	Bexar	B	IC	2,500	DFO	1974		Once Through	Reuse	
L		OW Summers	Bexar	C	IC	2,500	DFO	1974		Once Through	Reuse	
L		OW Summers	Bexar	D	IC	2,500	DFO	1974		Once Through	Reuse	
L	CPS San Antonio	VH Brauning	Bexar	1	ST	225,000	NG	1966	7,831,440	Once Through	Reuse	0.35
L		VH Brauning	Bexar	2	ST	252,000	NG	1968		Once Through	Reuse	
L		VH Brauning	Bexar	3	ST	417,000	NG	1970		Once Through	Reuse	
L	CPS San Antonio	WB Tuttle	Bexar	1	ST	75,000	NG	1954	4,336,200	Cooling Tower	Groundwater	0.75
L		WB Tuttle	Bexar	2	ST	114,000	NG	1956		Cooling Tower	Groundwater	
L		WB Tuttle	Bexar	3	ST	114,000	NG	1961		Cooling Tower	Groundwater	
L		WB Tuttle	Bexar	4	ST	192,000	NG	1963		Cooling Tower	Groundwater	
L	Energy Developments, Inc	Hutchins	Bexar		OT	2,700	LFG	unknown	23,652			0
L	Energy Developments, Inc	Tessman Road	Bexar		OT	5,200	LFG	unknown	45,552			0
L	AEP CPL	ES Joslin	Calhoun	1	ST	234,874	NG	1971	2,057,496	Once Through	Salt	0.35
L	GBRA	Canyon	Comal	1	HY	3,000	WAT	1989	52,560			0
L		Canyon	Comal	2	HY	3,000	WAT	1989				
L	Small Hydro of Texas Inc	Small Hydro of Texas Inc	DeWitt	01	HY	589	WAT	1992	5,160			0
L		Small Hydro of Texas Inc	DeWitt	02	HY	589	WAT	1993	5,160			0
L		Small Hydro of Texas Inc	DeWitt	03	HY	589	WAT	1993	5,160			0
L	Pearsall	Pearsall	Frio	1	ST	22,000	NG	1961	578,160	Cooling Tower	Groundwater	0.75
L		Pearsall	Frio	2	ST	22,000	NG	1961		Cooling Tower	Groundwater	
L		Pearsall	Frio	3	ST	22,000	NG	1961		Cooling Tower	Groundwater	
L	AEP CPL	Coleto Creek	Goliad	1	ST	570,057	BIT	1980	4,993,699	Once Through	Lake	0.35
L	Gonzales	Gonzales	Gonzales	1	HY	500	WAT	1984	13,140			0
L		Gonzales	Gonzales	2	HY	500	WAT	1984				
L		Gonzales	Gonzales	3	HY	500	WAT	1984				
L	GBRA	H 4	Gonzales	1	HY	2,400	WAT	1931	21,024			0
L	GBRA	H 5	Gonzales	1	HY	2,400	WAT	1931	21,024			0
L	GBRA	Abbott TP 3	Guadalupe	1	HY	1,400	WAT	1927	24,528			0
L		Abbott TP 3	Guadalupe	2	HY	1,400	WAT	1927				
L	GBRA	Dunlap TP 1	Guadalupe	1	HY	1,800	WAT	1927	31,536			0
L		Dunlap TP 1	Guadalupe	2	HY	1,800	WAT	1927				
L	GBRA	Nolte	Guadalupe	1	HY	1,200	WAT	1927	21,024			0
L		Nolte	Guadalupe	2	HY	1,200	WAT	1927				
L	Seguin	Seguin	Guadalupe	HY1	HY	250	WAT	1926	2,190			0
L		Seguin	Guadalupe	I-1	IC	250	DFO	1900	2,190			0
L	GBRA	TP 4	Guadalupe	1	HY	2,400	WAT	1932	21,024			0
L	Constellation	Rio Nogales Power Project	Guadalupe		CC	825,000	NG	2002	7,227,000			0.23
L	Panda	Guadalupe Generating Station	Guadalupe	STG1	CA	201,900	NG	2000	1,768,644			0.6
L		Guadalupe Generating Station	Guadalupe	STG2	CA	201,900	NG	2000	1,768,644			0.6
L		Guadalupe Generating Station	Guadalupe	CTG1	CT	184,600	NG	2000	1,617,096			0.05
L		Guadalupe Generating Station	Guadalupe	CTG2	CT	184,600	NG	2000	1,617,096			0.05
L		Guadalupe Generating Station	Guadalupe	CTG3	CT	184,600	NG	2000	1,617,096			0.05
L		Guadalupe Generating Station	Guadalupe	CTG4	CT	184,600	NG	2000	1,617,096			0.05
L	ANP	Hays Energy Project	Hays		CC	1,080,000	NG	2002	9,460,800			0.23
L	AEP CPL	Victoria	Victoria	4	ST	66,000	NG	1955	4,037,256	Once Through, Cooling Tower	River, Groundwater	0.75
L		Victoria	Victoria	5	ST	160,000	NG	1963		Once Through, Cooling Tower	River, Groundwater	
L		Victoria	Victoria	6	ST	234,874	NG	1968		Cooling Tower	Groundwater	
L	STEC	Sam Rayburn	Victoria	1	GT	11,250	NG	1964	197,100			0
L		Sam Rayburn	Victoria	2	GT	11,250	NG	1964				
L		Sam Rayburn	Victoria	3	ST	22,000	NG	1965	192,720	Once Through	River	0.35
L		Sam Rayburn	Victoria	4	IC	1,600	DFO	1991	28,032			0
L		Sam Rayburn	Victoria	5	IC	1,600	DFO	1991				
L		Sam Rayburn	Victoria		CC	185,000	NG	2003	1,620,600			0.05

Data from US DOE Energy Information Administration's Forms EIA-806A, EIA-806B, EIA-906, and PUCT Report on New Electric Generating Plants in Texas

Electric Utility and Independent Power Producer Generating Units in Texas

Region	Company	Plant	County	Unit	Prime Mover	Nameplate (kW)	Fuel Source	Year in Service	Annual Capability at 100% Load Factor (MWhrs)	Cooling Type	Water Source	Water Use Factor (gal/kWhr)
M	AEP CPL	La Palma	Cameron	4	ST	20,000	NG	1947	1,692,651	Cooling Tower	Surface	0.75
M		La Palma	Cameron	5	ST	20,000	NG	1949		Cooling Tower	Surface	
M		La Palma	Cameron	6	ST	153,225	NG	1970		Cooling Tower	Surface	
M		La Palma	Cameron	7	GT	49,100	NG	1975	430,116			0
M	PUB Brownsville	Silas Ray	Cameron	5	ST	25,000	NG	1952	219,000	Cooling Tower	Surface	0.75
M		Silas Ray	Cameron	6	CA	22,000	NG	1959	657,000	Cooling Tower	Surface	0.23
M		Silas Ray	Cameron	8	GT	45,000	NG	1973	394,200			0
M		Silas Ray	Cameron	9	CT	53,000	NG	1996				
M	AEP CPL	JL Bates	Hidalgo	1	ST	66,000	NG	1958	1,454,160	Cooling Tower	Surface, Groundwater	0.75
M		JL Bates	Hidalgo	2	ST	100,000	NG	1960		Cooling Tower	Surface, Groundwater	
M	Calpine	Hidalgo Energy Center	Hidalgo	CTG1	CT	162,300	NG	2000	1,421,748			0.05
M		Hidalgo Energy Center	Hidalgo	CTG2	CT	162,300	NG	2000	1,421,748			0.05
M		Hidalgo Energy Center	Hidalgo	STG1	CA	175,400	NG	2000	1,536,504			0.6
M	Calpine	Magic Valley Generating Station	Hidalgo		CT	265,000	NG	2001	2,321,400			0.05
M		Magic Valley Generating Station	Hidalgo		CT	265,000	NG	2001	2,321,400			0.05
M		Magic Valley Generating Station	Hidalgo		CA	265,000	NG	2001	2,321,400			0.6
M	TECO	Frontera Generation Facility	Hidalgo	GEN1	CT	164,000	NG	1999	1,436,640			0.05
M		Frontera Generation Facility	Hidalgo	GEN2	CT	164,000	NG	1999	1,436,640			0.05
M		Frontera Generation Facility	Hidalgo	GEN3	CA	183,000	NG	2000	1,603,080			0.6
M	AEP CPL	Eagle Pass	Maverick	1	HY	4,000	WAT	1932	105,120			0
M		Eagle Pass	Maverick	2	HY	4,000	WAT	1932				
M		Eagle Pass	Maverick	3	HY	4,000	WAT	1932				
M	IBWC	Falcon	Starr	1	HY	10,500	WAT	1954	275,940			0
M		Falcon	Starr	2	HY	10,500	WAT	1954				
M		Falcon	Starr	3	HY	10,500	WAT	1954				
M	AEP CPL	Laredo	Webb	1	ST	30,000	NG	1951	1,474,220	Cooling Tower	Surface	0.75
M		Laredo	Webb	2	ST	33,000	NG	1955		Cooling Tower	Surface	
M		Laredo	Webb	3	ST	105,290	NG	1975		Cooling Tower	Surface	
N	Crosstex	Duval	Duval		OT	310,000	OTH	2005	2,715,600			0
N	AEP CPL	Barney M Davis	Nueces	1	ST	323,449	NG	1974	5,668,973	Once Through	Salt	0.27
N		Barney M Davis	Nueces	2	ST	323,694	NG	1976		Once Through	Salt	
N	AEP CPL	Lon C Hill	Nueces	1	ST	60,000	NG	1954	4,475,256	Cooling Tower	Surface	0.75
N		Lon C Hill	Nueces	2	ST	66,000	NG	1956		Cooling Tower	Surface	
N		Lon C Hill	Nueces	3	ST	150,000	NG	1959		Cooling Tower	Surface	
N		Lon C Hill	Nueces	4	ST	234,874	NG	1969		Cooling Tower	Surface	
N	AEP CPL	Nueces Bay	Nueces	5	ST	30,000	NG	1949	4,499,959	Once Through	Salt	0.27
N		Nueces Bay	Nueces	6	ST	160,000	NG	1965		Once Through	Salt	
N		Nueces Bay	Nueces	7	ST	323,694	NG	1972		Once Through	Salt	
N	Avista	Nueces Energy Project	Nueces		CC	1,200,000	NG	unknown	10,512,000			0.23
N	Robstown	Robstown	Nueces	10	IC	4,150	NG	1967	184,582			0
N		Robstown	Nueces	11	IC	5,000	NG	1972				
N		Robstown	Nueces	3	IC	2,450	NG	1958				
N		Robstown	Nueces	4	IC	2,428	NG	1979				
N		Robstown	Nueces	5	IC	2,428	NG	1979				
N		Robstown	Nueces	7	IC	1,000	NG	1955				
N		Robstown	Nueces	8	IC	1,000	NG	1956				
N		Robstown	Nueces	9	IC	2,615	NG	1962				
O	Floyddada	Floyddada	Floyd	2	IC	1,250	NG	1952	61,320			0
O		Floyddada	Floyd	3	IC	1,250	NG	1958				
O		Floyddada	Floyd	4	IC	1,250	NG	1974				
O		Floyddada	Floyd	5	IC	1,250	NG	1974				
O		Floyddada	Floyd	6	IC	2,000	NG	1976				
O	Xcel SPS	Plant X	Lamb	1	ST	48,000	NG	1952	3,805,344	Cooling Tower	Groundwater	0.75

Data from US DOE Energy Information Administration's Forms EIA-806A, EIA-806B, EIA-906, and PUCT Report - New Electric Generating Plants in Texas

Electric Utility and Independent Power Producer Generating Units in Texas

Region	Company	Plant	County	Unit	Prime Mover	Nameplate (kW)	Fuel Source	Year in Service	Annual Capability at 100% Load Factor (MWhrs)	Cooling Type	Water Source	Water Use Factor (gal/kWhr)
O		Plant X	Lamb	2	ST	98,000	NG	1953		Cooling Tower	Groundwater	
O		Plant X	Lamb	3	ST	98,000	NG	1955		Cooling Tower	Groundwater	
O		Plant X	Lamb	4	ST	190,400	NG	1964		Cooling Tower	Groundwater	
O	Xcel SPS	Toik	Lamb	1	ST	568,000	SUB	1982	9,951,360	Cooling Tower	Groundwater	0.6
O		Toik	Lamb	2	ST	568,000	SUB	1985		Cooling Tower	Groundwater	
O	Cielo / Lubbock P&L	Llano Estacado Wind Ranch	Lubbock		WT	2,640	WIND	2002	23,126			0
O	Lubbock	Brandon	Lubbock	1	GT	21,000	NG	1990	183,960			0.05
O		J Robert Massengale	Lubbock	4	ST	11,500	NG	1952	201,480	Cooling Tower	Reuse	0.75
O		J Robert Massengale	Lubbock	5	ST	11,500	NG	1953		Cooling Tower	Reuse	
O		J Robert Massengale	Lubbock	6A	CA	22,000	NG	1997	735,840	Cooling Tower	Reuse	0.23
O		J Robert Massengale	Lubbock	7	CA	22,000	NG	1959		Cooling Tower	Reuse	0.23
O		J Robert Massengale	Lubbock	8	CT	40,000	NG	2000				
O	Xcel SPS	Jones	Lubbock	1	ST	248,000	NG	1971	4,344,960	Cooling Tower	Reuse	0.6
O		Jones	Lubbock	2	ST	248,000	NG	1974		Cooling Tower	Reuse	
O	Lubbock	Ty Cooke (Holly Ave.)	Lubbock	GT1	GT	12,500	NG	1964	464,280			0
O		Ty Cooke (Holly Ave.)	Lubbock	GT2	GT	18,500	NG	1971				
O		Ty Cooke (Holly Ave.)	Lubbock	GT3	GT	22,000	NG	1974				
O		Ty Cooke (Holly Ave.)	Lubbock	1	ST	44,000	NG	1965	855,414	Cooling Tower	Reuse	0.75
O		Ty Cooke (Holly Ave.)	Lubbock	2	ST	53,650	NG	1978		Cooling Tower	Reuse	
O	Tulia	Tulia	Swisher	10	IC	1,700	NG	1971	146,292			0
O		Tulia	Swisher	11	IC	4,800	NG	1974				
O		Tulia	Swisher	12	IC	3,000	NG	1979				
O		Tulia	Swisher	2	IC	400	NG	1949				
O		Tulia	Swisher	5	IC	1,000	NG	1953				
O		Tulia	Swisher	6	IC	1,100	NG	1957				
O		Tulia	Swisher	7	IC	1,100	NG	1957				
O		Tulia	Swisher	8	IC	1,800	NG	1963				
O		Tulia	Swisher	9	IC	1,800	NG	1963				
O	Brownfield	Brownfield	Terry	GT1	GT	6,500	NG	1973	56,940			0
O		Brownfield	Terry	1	IC	2,000	NG	1951	117,559			0
O		Brownfield	Terry	3	IC	3,100	NG	1964				
O		Brownfield	Terry	4	IC	2,700	NG	1954				
O		Brownfield	Terry	5	IC	3,620	NG	1957				
O		Brownfield	Terry	6	IC	4,000	NG	1961				
O	Golden Spread Coop	Mustang Station	Yoakum	GEN1	CT	174,204	NG	1999	1,526,027			0.05
O		Mustang Station	Yoakum	GEN2	CT	174,204	NG	1999	1,526,027			0.05
O		Mustang Station	Yoakum	GEN3	CA	172,647	NG	1999	1,512,388			0.6
Cancelled Projects per PUCT												
C	Steag	Watermill Electric Generating Facility - Avista	Ellis		CC	1,200,000						
C	KM Power	KM Power	Wise		CC	510,000						
D	Constellation	Gateway Power Project	Upshur		CC	825,000						
H	BP	Cinergy / BP - Texas City	Galveston		CT	70,000						
H	KM Power	KM Power	Harris		CC	1,070,000						
H	Celanese	Pasadena	Harris		CC	284,000						
M	ANP	Edinburg	Hidalgo		CC	550,000						

Data from US DOE Energy Information Administration's Forms EIA-806A, EIA-806B, EIA-906, and PUCT Report on New Electric Generating Plants in Texas

2000 Electric Generation from Electric Utility and Independent Power Producer Plants in Texas

Region	Company	Plant	County	Unit	2000 Net Generation (MWh)						2000 Total Generation for Plant / Region (MWh)	Percent of State Total Generation for 2000
					Coal	Lignite	Natural Gas	Nuclear	Fuel Oil	Combined Cycle		
A	Cielo / LPL	Llano Estacado Wind Ranch - White Deer	Carson								0	0
A	Xcel SPS	Celanese	Gray	1								0
A		Celanese	Gray	2								0
A	Xcel SPS	Riverview	Hutchinson	6			6,176					6,176
A	Xcel SPS	Moore County	Moore	3			52,260					52,260
A	Xcel SPS	Harrington	Potter	1	8,019,390		9,556					8,028,946
A		Harrington	Potter	2								0
A		Harrington	Potter	3								0
A	Xcel SPS	Nichols	Potter	1			993,701					993,701
A		Nichols	Potter	2								0
A		Nichols	Potter	3								0
A	Total											9,081,083
B	Panda	Archer Power Partners	Archer							0		0
B	AEP WTU	Lake Pauline	Hardeman	1			23,719					23,719
B		Lake Pauline	Hardeman	2								0
B	Electra	Electra	Wichita	3								0
B		Electra	Wichita	4								0
B		Electra	Wichita	5								0
B		Electra	Wichita	6								0
B		Electra	Wichita	7								0
B		Electra	Wichita	8								0
B	Mirant	Southern Energy Wichita Falls LP	Wichita	GTA						137,834		137,834
B		Southern Energy Wichita Falls LP	Wichita	GTB						125,681		125,681
B		Southern Energy Wichita Falls LP	Wichita	GTC						131,478		131,478
B		Southern Energy Wichita Falls LP	Wichita	STD						101,276		101,276
B	AEP WTU	Oklaunion	Wilbarger	1	4,449,860					9,183		4,459,043
B	AEP WTU	Vernon	Wilbarger	1						3		3
B		Vernon	Wilbarger	2								0
B		Vernon	Wilbarger	3								0
B		Vernon	Wilbarger	4								0
B		Vernon	Wilbarger	7								0
B	Total											4,979,034
C	TXU	Collin	Collin	1			296,614			650		297,264
C	Garland	Ray Olinger	Collin	1			1,078,894			7,306		1,086,200
C		Ray Olinger	Collin	2								0
C		Ray Olinger	Collin	3								0
C		Ray Olinger	Collin	4								0
C	Garland	CE Newman	Dallas	1			51,717			380		52,097
C		CE Newman	Dallas	2								0
C		CE Newman	Dallas	3								0
C		CE Newman	Dallas	4								0
C		CE Newman	Dallas	5								0
C	TXU	Lake Hubbard	Dallas	1			2,605,752			60,030		2,665,782
C		Lake Hubbard	Dallas	2								0
C	Exelon	Mountain Creek	Dallas	2			2,271,587			11,600		2,283,187
C		Mountain Creek	Dallas	3								0
C		Mountain Creek	Dallas	6								0
C		Mountain Creek	Dallas	7								0
C		Mountain Creek	Dallas	8								0
C	TXU	North Lake	Dallas	1			1,878,535			41,380		1,919,915
C		North Lake	Dallas	2								0
C		North Lake	Dallas	3								0
C	TXU	Parkdale	Dallas	1			613,856					613,856
C		Parkdale	Dallas	2								0
C		Parkdale	Dallas	3								0
C	Bio-Energy Partners	DFW Gas Recovery	Denton	GEN1							21,212	21,212
C		DFW Gas Recovery	Denton	GEN2							22,379	22,379
C	Lewisville	Lewisville	Denton	1							2,389	2,389
C	Lewisville	Ray Roberts	Denton	1							2,236	2,236

Data from US DOE Energy Information Administration's Forms EIA-860A, EIA-860B, and EIA-906

2000 Electric Generation from Electric Utility and Independent Power Producer Plants in Texas

Region	Company	Plant	County	Unit	2000 Net Generation (MWh)						2000 Total Generation for Plant / Region (MWh)	Percent of State Total Generation for 2000		
					Coal	Lignite	Natural Gas	Nuclear	Fuel Oil	Combined Cycle			Hydro and Renewable	
C	Lewisville	Spencer	Denton	1			258,291		247			258,538	0.08%	
		Spencer	Denton	2								0		
		Spencer	Denton	3								0		
		Spencer	Denton	4								0		
		Spencer	Denton	5								0		
	ANP	Midlothian Energy Facility	Ellis	STK1							387,003		387,003	0.12%
		Midlothian Energy Facility	Ellis	STK2							387,570		387,570	0.12%
		Midlothian Energy Facility	Ellis	STK3							132,599		132,599	0.04%
		Midlothian Energy Facility	Ellis	STK4							87,819		87,819	0.03%
		Midlothian Energy Facility	Ellis	STK5							0		0	
		Midlothian Energy Facility	Ellis	STK6							0		0	
	Tractebel TXU	Ennis Tractebel Power Co LP	Ellis								0		0	
		Ennis Tractebel Power Co LP	Ellis								0		0	
		Valley	Fannin	1			3,153,961		39,750				3,193,711	1.03%
	Calpine TXU	Valley	Fannin	2									0	
		Valley	Fannin	3									0	
		Freestone Power Generation LP	Freestone								0		0	
	USCE	Big Brown	Freestone	1	3,554,856	4,953,295	36,832						8,544,983	2.75%
		Big Brown	Freestone	2									0	
	Whitesboro	Denison	Grayson	1								194,075	194,075	0.06%
		Denison	Grayson	2									0	
		Whitesboro	Grayson	3									0	
		Whitesboro	Grayson	4									0	
	TXU	Trinidad	Henderson	D1						445			445	0.00%
		Trinidad	Henderson	D2									0	
Trinidad		Henderson	6			395,911		1,570				397,481	0.13%	
Duke Energy Cobisa / FP&L	Jack Energy Facility	Jack								0		0		
	Fomey Power Plant	Kaufman								0		0		
Duke Energy Brazos Electric	Kaufman LP Facility	Kaufman								0		0		
	North Texas	Parker	1			30,740		484				31,224	0.01%	
	North Texas	Parker	2									0		
Mirant Weatherford	North Texas	Parker	3									0		
	Mirant	Parker								0		0		
	Weatherford	Parker	1									0		
	Weatherford	Parker	2									0		
	Weatherford	Parker	3									0		
	Weatherford	Parker	4									0		
	Weatherford	Parker	6									0		
	Weatherford	Parker	7									0		
TXU	Weatherford	Parker	8									0		
	Eagle Mountain	Tarrant	1			930,045		5,642				935,687	0.30%	
	Eagle Mountain	Tarrant	2									0		
Exelon	Eagle Mountain	Tarrant	3									0		
	Handley	Tarrant	1			2,923,870		84,520				3,008,390	0.97%	
	Handley	Tarrant	2									0		
	Handley	Tarrant	3									0		
	Handley	Tarrant	4									0		
TXU Tractebel	Handley	Tarrant	5									0		
	North Main	Tarrant	4			145,506						145,506	0.05%	
C	Tractebel	Wise County Power Co LP	Wise							0		0		
	Total											28,671,548	8.59%	
D	AEP SWEPCO	Knox Lee	Gregg	2			1,265,314		30,880			1,296,194	0.42%	
		Knox Lee	Gregg	3								0		
		Knox Lee	Gregg	4								0		
		Knox Lee	Gregg	5								0		
	AEP SWEPCO Entergy / NE TX Coop Cobisa	Pirkey Hamson County Power Project Greenville	Hamson Hunt	1		4,330,807	24,191				0	4,354,998	1.40%	
									0		0			

Data from US DOE Energy Information Administration's Forms EIA-860A, EIA-860B, and EIA-906

2000 Electric Generation from Electric Utility and Independent Power Producer Plants in Texas

Region	Company	Plant	County	Unit	2000 Net Generation (MWh)							2000 Total Generation for Plant / Region (MWh)	Percent of State Total Generation for 2000
					Coal	Lignite	Natural Gas	Nuclear	Fuel Oil	Combined Cycle	Hydro and Renewable		
D	Greenville	Powerlane	Hunt	ST1								0	
D		Powerlane	Hunt	ST2								0	
D		Powerlane	Hunt	ST3								0	
D	Panda	Lamar Power Project	Lamar	CTG2						631,048		631,048	0.20%
D		Lamar Power Project	Lamar	CTG1						660,299		660,299	0.21%
D		Lamar Power Project	Lamar	STG1						736,257		736,257	0.24%
D		Lamar Power Project	Lamar	STG2						59,584		59,584	0.02%
D		Lamar Power Project	Lamar	CTG3						65,391		65,391	0.02%
D		Lamar Power Project	Lamar	CTG4						61,912		61,912	0.02%
D	AEP SWEPCO	Wilkes	Marion	1			2,378,797			10,239		2,389,036	0.77%
D		Wilkes	Marion	2								0	
D		Wilkes	Marion	3								0	
D	AEP SWEPCO	Lone Star	Morris	1			56,442					56,442	0.02%
D	TXU	River Crest	Red River	1			183,042					183,042	0.06%
D	TXU	Monticello	Titus	1	3,147,809	9,195,971				26,482		12,370,262	3.99%
D		Monticello	Titus	2								0	
D		Monticello	Titus	3								0	
D	AEP SWEPCO	Welsh	Titus	1	10,808,875					10,437		10,819,312	3.49%
D		Welsh	Titus	2								0	
D		Welsh	Titus	3								0	
D	Total											33,683,778	10.85%
E	LCRA	West Texas Windplant	Culberson	WIND							81,834	81,834	0.03%
E	National Wind Power	Delaware Mountain Windfarm	Culberson	WIND							75,993	75,993	0.02%
E	Onion Energy	Orion	Culberson								0	0	
E	ANP	West Texas Energy Facility	EI Paso							0		0	
E	Cielo / EI Paso Electric	Hueco Mountain Wind Ranch	EI Paso								0	0	
E	EI Paso	Copper	EI Paso	1			85,962					85,962	0.03%
E	EI Paso	Newman	EI Paso	CT1								0	
E		Newman	EI Paso	CT2								0	
E		Newman	EI Paso	1			838,291					838,291	0.27%
E		Newman	EI Paso	2								0	
E		Newman	EI Paso	3								0	
E		Newman	EI Paso	4								0	
E	AEP WTU	Fort Davis	Jeff Davis	1					3,008	1,223,804		1,226,812	0.40%
E	AEP - WTU	Fort Davis	Jeff Davis								0	0	
E	AEP WTU	Presidio	Presidio	5					15			15	0.00%
E		Presidio	Presidio	6								0	
E	Total											2,308,908	0.74%
F	AEP WTU	Oak Creek	Coke	1			327,109					327,109	0.11%
F	Coleman	Coleman	Coleman	IC1			423		150			573	0.00%
F		Coleman	Coleman	IC2								0	
F		Coleman	Coleman	IC3								0	
F		Coleman	Coleman	IC4								0	
F		Coleman	Coleman	IC5								0	
F		Coleman	Coleman	IC6								0	
F		Coleman	Coleman	IC7								0	
F		Coleman	Coleman	IC8								0	
F		Coleman	Coleman	IC9								0	
F	AEP WTU	Rio Pecos	Crockett	4A								0	0.00%
F		Rio Pecos	Crockett	5						0		0	
F		Rio Pecos	Crockett	6			479,695		330			480,025	0.15%
F	Panda	Odessa-Ector Generating Station	Ector							0		0	
F		Odessa-Ector Generating Station	Ector							0		0	
F		Odessa-Ector Generating Station	Ector							0		0	
F		Odessa-Ector Generating Station	Ector							0		0	
F		Odessa-Ector Generating Station	Ector							0		0	
F		Odessa-Ector Generating Station	Ector							0		0	
F	York Research	Big Spring Wind Power Facility	Howard								101,197	101,197	0.03%
F	TXU	Morgan Creek	Mitchell	CT1			137,274			37,320		174,594	0.06%

Data from US DOE Energy Information Administration's Forms EIA-860A, EIA-860B, and EIA-906

2000 Electric Generation from Electric Utility and Independent Power Producer Plants in Texas

Region	Company	Plant	County	Unit	2000 Net Generation (MWh)						2000 Total Generation for Plant / Region (MWh)	Percent of State Total Generation for 2000	
					Coal	Lignite	Natural Gas	Nuclear	Fuel Oil	Combined Cycle			Hydro and Renewable
F		Morgan Creek	Mitchell	CT2								0	
F		Morgan Creek	Mitchell	CT3								0	
F		Morgan Creek	Mitchell	CT4								0	
F		Morgan Creek	Mitchell	CT5								0	
F		Morgan Creek	Mitchell	CT6								0	
F		Morgan Creek	Mitchell	2			3,422,062					3,422,062	1.10%
F		Morgan Creek	Mitchell	3								0	
F		Morgan Creek	Mitchell	4								0	
F		Morgan Creek	Mitchell	5								0	
F		Morgan Creek	Mitchell	6								0	
F	AEP	Desert Sky	Pecos								0	0	
F	AEP WTU	Fort Stockton	Pecos	2			18					18	0.00%
F	Cielo	Capital Hill	Pecos								0	0	
F	FP&L	Woodward Mountain Wind Ranch	Pecos								0	0	
F	Onon	Indian Mesa Wind Farm	Pecos								0	0	
F	AEP WTU	San Angelo	Tom Green	1								0	
F		San Angelo	Tom Green	2						757,421		757,421	0.24%
F	FP&L	King Mountain Wind Ranch	Upton								0	0	
F	FP&L	King Mountain Wind Ranch 1	Upton								0	0	
F	FP&L	King Mountain Wind Ranch 2	Upton								0	0	
F	FP&L	West Texas Wind Energy LLC - SW Mesa	Upton	01							238,092	238,092	0.08%
F	TXU Energy / Cielo Wind	Noelke Hill	Upton									0	
F	TXU	Permian Basin	Ward	CT1			153,181		12,375			165,556	0.05%
F		Permian Basin	Ward	CT2								0	
F		Permian Basin	Ward	CT3								0	
F		Permian Basin	Ward	CT4								0	
F		Permian Basin	Ward	CT5								0	
F		Permian Basin	Ward	5			2,919,605		9,210			2,928,815	0.94%
F		Permian Basin	Ward	6								0	
F	York Research	Notrees	Winkler								0	0	
F	Total											8,595,462	2.77%
G	Duke	Bell Energy Facility	Bell							0		0	
G	Mirant	Mirant Texas LP Bosque County Plant	Bosque	GT-1						265,443		265,443	0.09%
G		Mirant Texas LP Bosque County Plant	Bosque	GT-2						209,826		209,826	0.07%
G		Mirant Texas LP Bosque County Plant	Bosque	GT-3						209,826		209,826	0.07%
G		Mirant Texas LP Bosque County Plant	Bosque	ST						209,826		209,826	0.07%
G		Mirant Texas LP Bosque County Plant	Bosque							0		0	
G	USCE	Whitney	Bosque	1							11,437	11,437	0.00%
G		Whitney	Bosque	2								0	
G	Bryan	Atkins	Brazos	3			97,198		1,845			99,043	0.03%
G		Atkins	Brazos	4								0	
G		Atkins	Brazos	5								0	
G		Atkins	Brazos	6								0	
G		Atkins	Brazos	7			3,301					3,301	0.00%
G	Bryan	Dansby	Brazos	1			335,075		10,447			345,522	0.11%
G	TMPA	Gibbons Creek	Grimes	1	3,197,470		4,768					3,202,238	1.03%
G	Tenaska	Frontier Generation Station	Grimes	STG1						345,744		345,744	0.11%
G		Frontier Generation Station	Grimes	GTG3						157,530		157,530	0.05%
G		Frontier Generation Station	Grimes	GTG1						199,195		199,195	0.06%
G		Frontier Generation Station	Grimes	GTG2						174,128		174,128	0.06%
G	AEP WTU	Paint Creek	Haskell	1			429,943		15,763			445,706	0.14%
G		Paint Creek	Haskell	2								0	
G		Paint Creek	Haskell	3								0	
G		Paint Creek	Haskell	4								0	
G	AES	Wolf Hollow LP	Hood							0		0	
G	TXU	DeCordova	Hood	CT1			178,255		3,599			181,854	0.06%
G		DeCordova	Hood	CT2								0	
G		DeCordova	Hood	CT3								0	
G		DeCordova	Hood	CT4								0	
G		DeCordova	Hood	1			3,865,808		45,210			3,911,018	1.26%

Data from US DOE Energy Information Administration's Forms EIA-860A, EIA-860B, and EIA-906

2000 Electric Generation from Electric Utility and Independent Power Producer Plants in Texas

Region	Company	Plant	County	Unit	2000 Net Generation (MWh)							2000 Total Generation for Plant / Region (MWh)	Percent of State Total Generation for 2000
					Coal	Lignite	Natural Gas	Nuclear	Fuel Oil	Combined Cycle	Hydro and Renewable		
G	AEP WTU	Fort Phantom	Jones	1			1,267,324			59,275		1,326,599	0.43%
G		Fort Phantom	Jones	2								0	
G	Reliant	Limestone	Limestone	1		11,230,931	78,834					11,309,765	3.64%
G		Limestone	Limestone	2								0	
G	TXU	Lake Creek	McLennan	D1						740		740	0.00%
G		Lake Creek	McLennan	D2								0	
G		Lake Creek	McLennan	D3								0	
G		Lake Creek	McLennan	ST1			894,222			6,122		900,344	0.29%
G		Lake Creek	McLennan	ST2								0	
G	TXU	Tradinghouse	McLennan	1			5,331,118			70,235		5,401,353	1.74%
G		Tradinghouse	McLennan	2								0	
G	TXU	Sandow	Milam	4		3,547,822				8,888		3,556,710	1.15%
G	AEP	Trent Mesa	Nolan								0	0	
G	Enron	Enron Wind	Nolan								0	0	
G	TXU	Encogen One	Nolan	GT01						257,411		257,411	0.08%
G		Encogen One	Nolan	GT02						551,532		551,532	0.18%
G		Encogen One	Nolan	GT03						427,824		427,824	0.14%
G		Encogen One	Nolan	STG1						456,911		456,911	0.15%
G	BRA	Morris Sheppard	Palo Pinto	1							3,520	3,520	0.00%
G		Morris Sheppard	Palo Pinto	2								0	
G	Brazos Electric	RW Miller	Palo Pinto	1			1,520,085			59		1,520,144	0.49%
G		RW Miller	Palo Pinto	2								0	
G		RW Miller	Palo Pinto	3								0	
G		RW Miller	Palo Pinto	4			256,166			8,284		264,450	0.09%
G		RW Miller	Palo Pinto	5								0	
G	TNM	TNP One	Robertson	1		2,182,885	32,330					2,215,215	0.71%
G		TNP One	Robertson	2								0	
G	TXU	Comanche Peak	Somervell	1				9,599,797				9,599,797	3.09%
G		Comanche Peak	Somervell	2				8,857,071				8,857,071	2.85%
G	AEP WTU	Ablene	Taylor	4			9,573					9,573	0.00%
G	TXU	Graham	Young	1			2,271,415			21,909		2,293,324	0.74%
G		Graham	Young	2								0	
G	Total											58,923,920	18.99%
H	Reliant Energy Renewables	Coastal Plains	Brazoria								0	0	
H	Energy Developments, Inc	Alta Loma	Chambers								0	0	
H	Reliant	Cedar Bayou	Chambers	1			7,993,623			207,696		8,201,319	2.64%
H		Cedar Bayou	Chambers	2								0	
H		Cedar Bayou	Chambers	3								0	
H	Avista / NRG Energy	Brazos Valley Generating Facility	Fort Bend							0		0	
H	Reliant	WA Parish	Fort Bend	GT1				2,897				2,897	0.00%
H		WA Parish	Fort Bend	1				2,712,837				2,712,837	0.87%
H		WA Parish	Fort Bend	2								0	
H		WA Parish	Fort Bend	3								0	
H		WA Parish	Fort Bend	4								0	
H		WA Parish	Fort Bend	5		7,731,899						7,731,899	2.49%
H		WA Parish	Fort Bend	6								0	
H		WA Parish	Fort Bend	7		7,731,899						7,731,899	2.49%
H		WA Parish	Fort Bend	8								0	
H	Reliant	PH Robinson	Galveston	1			9,308,940					9,308,940	3.00%
H		PH Robinson	Galveston	2								0	
H		PH Robinson	Galveston	3								0	
H		PH Robinson	Galveston	4								0	
H	ANP	Harris Energy Facility	Harris							0		0	
H	Energy Developments, Inc	Whispering Pines	Harris							0		0	
H	Exelon	LaPorte Generating Station	Harris				0					0	
H		LaPorte Generating Station	Harris									0	
H		LaPorte Generating Station	Harris									0	
H		LaPorte Generating Station	Harris									0	
H	Reliant	Deepwater	Harris	7			191,096					191,096	0.06%
H	Reliant	Greens Bayou	Harris	5			687,984			14,349		702,333	0.23%

Data from US DOE Energy Information Administration's Forms EIA-860A, EIA-860B, and EIA-906

2000 Electric Generation from Electric Utility and Independent Power Producer Plants in Texas

Region	Company	Plant	County	Unit	2000 Net Generation (MWh)							2000 Total Generation for Plant / Region (MWh)	Percent of State Total Generation for 2000
					Coal	Lignite	Natural Gas	Nuclear	Fuel Oil	Combined Cycle	Hydro and Renewable		
H		Greens Bayou	Harris	73			179,031			12,859		191,890	0.06%
H		Greens Bayou	Harris	74								0	
H		Greens Bayou	Harris	81								0	
H		Greens Bayou	Harris	82								0	
H		Greens Bayou	Harris	83								0	
H		Greens Bayou	Harris	84								0	
H	Reliant	Hiram Clark	Harris	GT1			19,810					19,810	0.01%
H		Hiram Clark	Harris	GT2								0	
H		Hiram Clark	Harris	GT3								0	
H		Hiram Clark	Harris	GT4								0	
H		Hiram Clark	Harris	5								0	
H		Hiram Clark	Harris	6								0	
H	Reliant	Sam Bertron	Harris	GT1			5,115					5,115	0.00%
H		Sam Bertron	Harris	GT2								0	
H		Sam Bertron	Harris	ST1			1,863,287					1,863,287	0.60%
H		Sam Bertron	Harris	ST2								0	
H		Sam Bertron	Harris	3								0	
H		Sam Bertron	Harris	4								0	
H		Sam Bertron	Harris	G1								0	
H	Reliant	San Jacinto SES	Harris	SJS1			1,367,335					1,367,335	0.44%
H		San Jacinto SES	Harris	SJS2								0	
H	Reliant	TH Wharton	Harris	2			593,524					593,524	0.19%
H		TH Wharton	Harris	3						3,165,392		3,165,392	1.02%
H		TH Wharton	Harris	31								0	
H		TH Wharton	Harris	32								0	
H		TH Wharton	Harris	33								0	
H		TH Wharton	Harris	34								0	
H		TH Wharton	Harris	4								0	
H		TH Wharton	Harris	41								0	
H		TH Wharton	Harris	42								0	
H		TH Wharton	Harris	43								0	
H		TH Wharton	Harris	44								0	
H		TH Wharton	Harris	51			265,853					265,853	0.09%
H		TH Wharton	Harris	52								0	
H		TH Wharton	Harris	53								0	
H		TH Wharton	Harris	54								0	
H		TH Wharton	Harris	55								0	
H		TH Wharton	Harris	56								0	
H		TH Wharton	Harris	GT1								0	
H	Reliant	Webster	Harris	GT1			2,231					2,231	0.00%
H		Webster	Harris	3			497,488					497,488	0.16%
H	Reliant Energy Renewables	Atascosita LP	Harris								0	0	
H	Reliant Energy Renewables	Baytown	Harris								0	0	
H	Reliant Energy Renewables	Blue Bonnet	Harris								0	0	
H	HNG	Dayton Storage Co	Liberty								0	0	
H	Reliant Energy Renewables	Security	Liberty								0	0	
H	Sempra	Cedar Bluff Power Project	Liberty							0		0	
H	Entergy Gulf States	Lewis Creek	Montgomery	1			2,855,245					2,855,245	0.92%
H		Lewis Creek	Montgomery	2								0	
H	Reliant Energy Renewables	Conroe	Montgomery								0	0	
H	Sempra	Montgomery County Energy Project	Montgomery							0		0	
H	Warren	Warren Peaking Power Facility	Montgomery							0		0	
H	Total											47,410,390	15.28%
I	Newport	Palestine Power Project	Anderson							0		0	
I	TXU	Stryker Creek	Cherokee	D1						1,280		1,280	0.00%
I		Stryker Creek	Cherokee	D2								0	
I		Stryker Creek	Cherokee	D3								0	
I		Stryker Creek	Cherokee	D4								0	
I		Stryker Creek	Cherokee	D5								0	
I		Stryker Creek	Cherokee	ST1			2,364,301			8,540		2,372,841	0.76%

Data from US DOE Energy Information Administration's Forms EIA-860A, EIA-860B, and EIA-906

2000 Electric Generation from Electric Utility and Independent Power Producer Plants in Texas

Region	Company	Plant	County	Unit	2000 Net Generation (MWh)						2000 Total Generation for Plant / Region (MWh)	Percent of State Total Generation for 2000	
					Coal	Lignite	Natural Gas	Nuclear	Fuel Oil	Combined Cycle			Hydro and Renewable
		Stryker Creek	Cherokee	ST2							0		
	USCE	Robert D Willis	Jasper	1							31,270	31,270	0.01%
		Robert D Willis	Jasper	2							0	0	
	USCE	Sam Rayburn	Jasper	1							37,035	37,035	0.01%
		Sam Rayburn	Jasper	2							0	0	
	Calpine	Amelia Energy Center	Jefferson							0	0	0	
	Port of Port Arthur	Sabine Power	Jefferson							0	0	0	
	Steag Power	Sterne Electric Generating Facility	Nacogdoches							0	0	0	
	Entergy Gulf States	Toledo Bend	Newton	1							102,942	102,942	0.03%
		Toledo Bend	Newton	2							0	0	
	Hartburg	Hartburg Power LP	Newton							0	0	0	
	Intergen	Cottonwood Energy Project	Newton							0	0	0	
	Entergy Gulf States	Sabine	Orange	1			8,531,873		75			8,531,948	2.75%
		Sabine	Orange	2							0	0	
		Sabine	Orange	3							0	0	
		Sabine	Orange	4							0	0	
		Sabine	Orange	5							0	0	
	TXU	Martin Lake	Rusk	1	863,636	15,632,556				27,698		16,523,889	5.32%
		Martin Lake	Rusk	2								0	
		Martin Lake	Rusk	3								0	
	Tenaska	Gateway Generating Station	Rusk							0		0	
		Gateway Generating Station	Rusk							0		0	
		Gateway Generating Station	Rusk							0		0	
		Gateway Generating Station	Rusk							0		0	
	Total											27,601,205	8.89%
J	IBWC	Amistad	Val Verde	1							86,024	86,024	0.03%
J		Amistad	Val Verde	2							0	0	
J	Total											86,024	0.03%
K	FP&L	Bastrop Energy Center	Bastrop							0		0	
K	Gentex / Calpine	Lost Pines I Power Project	Bastrop							0		0	
K		Lost Pines I Power Project	Bastrop							0		0	
K		Lost Pines I Power Project	Bastrop							0		0	
K	LCRA	Sim Gideon	Bastrop	1			2,214,828					2,214,828	0.71%
K		Sim Gideon	Bastrop	2								0	
K		Sim Gideon	Bastrop	3								0	
K	LCRA	Buchanan	Bumet	1							26,710	26,710	0.01%
K		Buchanan	Bumet	2							0	0	
K		Buchanan	Bumet	3							0	0	
K	LCRA	Granite Shoals	Bumet	1							40,644	40,644	0.01%
K		Granite Shoals	Bumet	2							0	0	
K	LCRA	Inks	Bumet	1							13,625	13,625	0.00%
K	LCRA	Marble Falls	Bumet	1							25,386	25,386	0.01%
K		Marble Falls	Bumet	2							0	0	
K	LCRA	Fayette	Fayette	1	11,860,743					11,245		11,871,988	3.83%
K		Fayette	Fayette	2								0	
K		Fayette	Fayette	3								0	
K	LCRA	Thomas C Ferguson	Llano	1			1,448,162					1,448,162	0.47%
K	Ridge Energy Storage	Markham Energy Storage Center	Matagorda								0	0	
K	Reliant	STP	Matagorda	1				8,556,165				8,556,165	2.76%
K		STP	Matagorda	2				10,542,774				10,542,774	3.40%
K	LCRA	Austin	Travis	1							27,773	27,773	0.01%
K		Austin	Travis	2							0	0	
K	Austin	Decker	Travis	GT1			64,102			70		64,172	0.02%
K		Decker	Travis	GT2								0	
K		Decker	Travis	GT3								0	
K		Decker	Travis	GT4								0	
K		Decker	Travis	PV3							41	41	0.00%
K		Decker	Travis	1			2,160,089			2,488		2,162,577	0.70%
K		Decker	Travis	2								0	

Data from US DOE Energy Information Administration's Forms EIA-860A, EIA-860B, and EIA-906

2000 Electric Generation from Electric Utility and Independent Power Producer Plants in Texas

Region	Company	Plant	County	Unit	2000 Net Generation (MMWh)						2000 Total Generation for Plant / Region (MMWh)	Percent of State Total Generation for 2000	
					Coal	Lignite	Natural Gas	Nuclear	Fuel Oil	Combined Cycle			Hydro and Renewable
K	Austin	Holly	Travis	1			1,244,904					1,244,904	0.40%
K		Holly	Travis	2								0	
K		Holly	Travis	3								0	
K		Holly	Travis	4								0	
K	Austin	Sand Hill	Travis	1			0					0	
K		Sand Hill	Travis	2								0	
K		Sand Hill	Travis	3								0	
K		Sand Hill	Travis	4								0	
K	Austin Energy	Sand Hill	Travis						0			0	
K		Sand Hill	Travis						0			0	
K	Ecogas	Ecogas	Travis							0		0	
K	LCRA	Marshall Ford	Travis	1							83,074	83,074	0.03%
K		Marshall Ford	Travis	2								0	
K		Marshall Ford	Travis	3								0	
K	AEP	Newgulf	Wharton	GEN1						26,921		26,921	0.01%
K		Newgulf	Wharton	GEN2						2,992		2,992	0.00%
K	Total											38,362,736	12.36%
L	San Miguel	San Miguel	Atascosa	1		2,976,019			4,022			2,980,041	0.96%
L	CPS San Antonio	A Von Rosenberg	Bexar	1								0	
L		A Von Rosenberg	Bexar	2								0	
L		A Von Rosenberg	Bexar	3								0	
L	CPS San Antonio	JK Spruce	Bexar	1	3,975,221				4,090	2,176,014		2,176,014	0.70%
L	CPS San Antonio	JT Deely	Bexar	1	5,531,703				3,139			3,979,311	1.28%
L		JT Deely	Bexar	2								5,534,842	1.78%
L		JT Deely	Bexar	3								0	
L	CPS San Antonio	Leon Creek	Bexar	3			90,621					90,621	0.03%
L		Leon Creek	Bexar	4								0	
L	CPS San Antonio	Mission Road	Bexar	3			55,598					55,598	0.02%
L	CPS San Antonio	OW Summers	Bexar	1			2,564,120		320			2,564,440	0.83%
L		OW Summers	Bexar	2								0	
L		OW Summers	Bexar	A								0	
L		OW Summers	Bexar	B								0	
L		OW Summers	Bexar	C								0	
L		OW Summers	Bexar	D								0	
L	CPS San Antonio	VH Brauning	Bexar	1			1,756,515		21,919			1,778,434	0.57%
L		VH Brauning	Bexar	2								0	
L		VH Brauning	Bexar	3								0	
L	CPS San Antonio	WB Tuttle	Bexar	1			359,784					359,784	0.12%
L		WB Tuttle	Bexar	2								0	
L		WB Tuttle	Bexar	3								0	
L		WB Tuttle	Bexar	4								0	
L	Energy Developments, Inc	Hutchins	Bexar								0	0	
L	Energy Developments, Inc	Tessman Road	Bexar								0	0	
L	AEP CPL	ES Joslin	Calhoun	1			572,417		28,825			601,242	0.19%
L	GBRA	Canyon	Comal	1							7,555	7,555	0.00%
L		Canyon	Comal	2								0	
L	Small Hydro of Texas Inc	Small Hydro of Texas Inc	DeWitt	01							1,808	1,808	0.00%
L		Small Hydro of Texas Inc	DeWitt	02							1,042	1,042	0.00%
L		Small Hydro of Texas Inc	DeWitt	03							695	695	0.00%
L	Pearsall	Pearsall	Frio	1			52,309		405			52,714	0.02%
L		Pearsall	Frio	2								0	
L		Pearsall	Frio	3								0	
L	AEP CPL	Coletto Creek	Goliad	1	4,820,148				3,586			4,823,734	1.55%
L	Gonzales	Gonzales	Gonzales	1								0	0
L		Gonzales	Gonzales	2								0	
L		Gonzales	Gonzales	3								0	
L	GBRA	H 4	Gonzales	1							6,714	6,714	0.00%
L	GBRA	H 5	Gonzales	1							278	278	0.00%
L	GBRA	Abbott TP 3	Guadalupe	1							7,582	7,582	0.00%
L		Abbott TP 3	Guadalupe	2								0	
L	GBRA	Dunlap TP 1	Guadalupe	1							11,601	11,601	0.00%

Data from US DOE Energy Information Administration's Forms EIA-860A, EIA-860B, and EIA-906

2000 Electric Generation from Electric Utility and Independent Power Producer Plants in Texas

Region	Company	Plant	County	Unit	Coal	2000 Net Generation (MWh)					2000 Total Generation for Plant / Region (MWh)	Percent of State Total Generation for 2000
						Lignite	Natural Gas	Nuclear	Fuel Oil	Combined Cycle		
L		Dunlap TP 1	Guadalupe	2							0	
L	GBRA	Notte	Guadalupe	1						6,232	6,232	0.00%
L		Notte	Guadalupe	2							0	
L	Seguin	Seguin	Guadalupe	HY1							0	
L		Seguin	Guadalupe	I-1							0	
L	GBRA	TP 4	Guadalupe	1						7,264	7,264	0.00%
L	Constellation	Rio Nogales Power Project	Guadalupe						0		0	
L	Panda	Guadalupe Generating Station	Guadalupe	STG1					38,646		38,646	0.01%
L		Guadalupe Generating Station	Guadalupe	STG2					19,909		19,909	0.01%
L		Guadalupe Generating Station	Guadalupe	CTG1					27,228		27,228	0.01%
L		Guadalupe Generating Station	Guadalupe	CTG2					30,741		30,741	0.01%
L		Guadalupe Generating Station	Guadalupe	CTG3					18,445		18,445	0.01%
L		Guadalupe Generating Station	Guadalupe	CTG4					11,418		11,418	0.00%
L	ANP	Hays Energy Project	Hays						0		0	
L	AEP CPL	Victoria	Victoria	4		882,886			9,380		892,276	0.29%
L		Victoria	Victoria	5							0	
L		Victoria	Victoria	6							0	
L	STEC	Sam Rayburn	Victoria	1		2,383					2,383	0.00%
L		Sam Rayburn	Victoria	2							0	
L		Sam Rayburn	Victoria	3		18,821			1		18,822	0.01%
L		Sam Rayburn	Victoria	4					199		199	0.00%
L		Sam Rayburn	Victoria	5							0	
L		Sam Rayburn	Victoria							0	0	
L	Total										26,107,813	8.41%
M	AEP CPL	La Palma	Cameron	4		587,356			25,684		613,040	0.20%
M		La Palma	Cameron	5							0	
M		La Palma	Cameron	6							0	
M		La Palma	Cameron	7							0	
M	PUB Brownsville	Silas Ray	Cameron	5		1,160					1,160	0.00%
M		Silas Ray	Cameron	6							0	
M		Silas Ray	Cameron	8		109,108					109,108	0.04%
M		Silas Ray	Cameron	9							0	
M	AEP CPL	JL Bates	Hidalgo	1		496,880			24,806		521,686	0.17%
M		JL Bates	Hidalgo	2							0	
M	Calpine	Hidalgo Energy Center	Hidalgo	CTG1						329,566	329,566	0.11%
M		Hidalgo Energy Center	Hidalgo	CTG2						376,476	376,476	0.12%
M		Hidalgo Energy Center	Hidalgo	STG1						409,994	409,994	0.13%
M	Calpine	Magic Valley Generating Station	Hidalgo							0	0	
M		Magic Valley Generating Station	Hidalgo							0	0	
M		Magic Valley Generating Station	Hidalgo							0	0	
M	TECO	Frontera Generation Facility	Hidalgo	GEN1						465,202	465,202	0.15%
M		Frontera Generation Facility	Hidalgo	GEN2						498,606	498,606	0.16%
M		Frontera Generation Facility	Hidalgo	GEN3						586,246	586,246	0.19%
M	AEP CPL	Eagle Pass	Maverick	1						48,593	48,593	0.02%
M		Eagle Pass	Maverick	2							0	
M		Eagle Pass	Maverick	3							0	
M	IBWC	Falcon	Starr	1						41,494	41,494	0.01%
M		Falcon	Starr	2							0	
M		Falcon	Starr	3							0	
M	AEP CPL	Laredo	Webb	1		734,372			1,604		735,976	0.24%
M		Laredo	Webb	2							0	
M		Laredo	Webb	3							0	
M	Total										4,737,147	1.53%
N	Crosstex	Duval	Duval							0	0	
N	AEP CPL	Barney M Davis	Nueces	1		3,400,993			54,941		3,455,934	1.11%
N		Barney M Davis	Nueces	2							0	
N	AEP CPL	Lon C Hill	Nueces	1		1,515,097			29,962		1,545,059	0.50%
N		Lon C Hill	Nueces	2							0	
N		Lon C Hill	Nueces	3							0	

Data from US DOE Energy Information Administration's Forms EIA-860A, EIA-860B, and EIA-906

2000 Electric Generation from Electric Utility and Independent Power Producer Plants in Texas

Region	Company	Plant	County	Unit	2000 Net Generation (MWh)						2000 Total Generation for Region (MWh)	Percent of State Total Generation for 2000
					Coal	Lignite	Natural Gas	Nuclear	Fuel Oil	Combined Cycle		
N	AEP CPL	Lon C Hill	Nueces	4							0	
N		Nueces Bay	Nueces	5			2,260,823		13,450		2,274,273	0.73%
N		Nueces Bay	Nueces	6							0	
N	Avista	Nueces Bay	Nueces	7							0	
N		Nueces Energy Project	Nueces							0	0	
N	Robstown	Robstown	Nueces	10			27,554		3,534		31,088	0.01%
N		Robstown	Nueces	11							0	
N		Robstown	Nueces	3							0	
N		Robstown	Nueces	4							0	
N		Robstown	Nueces	5							0	
N		Robstown	Nueces	7							0	
N		Robstown	Nueces	8							0	
N	Total	Robstown	Nueces	9							7,306,354	2.35%
O	Floydada	Floydada	Floyd	2							0	
O		Floydada	Floyd	3							0	
O		Floydada	Floyd	4							0	
O		Floydada	Floyd	5							0	
O		Floydada	Floyd	6							0	
O	Xcel SPS	Plant X	Lamb	1			841,563		23,020		864,583	0.28%
O		Plant X	Lamb	2							0	
O		Plant X	Lamb	3							0	
O		Plant X	Lamb	4							0	
O	Xcel SPS	Tolk	Lamb	1			7,558				8,140,435	2.62%
O		Tolk	Lamb	2							0	
O	Cielo / Lubbock P&L	Llano Estacado Wind Ranch	Lubbock							0	0	
O	Lubbock	Brandon	Lubbock	1			137,668				137,668	0.04%
O	Lubbock	J Robert Massengale	Lubbock	4			76,566				76,566	0.02%
O		J Robert Massengale	Lubbock	5							0	
O		J Robert Massengale	Lubbock	6A						0	0	
O		J Robert Massengale	Lubbock	7						0	0	
O		J Robert Massengale	Lubbock	8						0	0	
O	Xcel SPS	Jones	Lubbock	1			2,363,065		9,210		2,372,275	0.76%
O		Jones	Lubbock	2							0	
O	Lubbock	Ty Cooke (Holly Ave.)	Lubbock	GT1			33,834				33,834	0.01%
O		Ty Cooke (Holly Ave.)	Lubbock	GT2							0	
O		Ty Cooke (Holly Ave.)	Lubbock	GT3							0	
O		Ty Cooke (Holly Ave.)	Lubbock	1			384,819				384,819	0.12%
O	Tulia	Ty Cooke (Holly Ave.)	Lubbock	2							0	
O		Tulia	Swisher	10							0	
O		Tulia	Swisher	11							0	
O		Tulia	Swisher	12							0	
O		Tulia	Swisher	2							0	
O		Tulia	Swisher	5							0	
O		Tulia	Swisher	6							0	
O		Tulia	Swisher	7							0	
O	Brownfield	Tulia	Swisher	8							0	
O		Tulia	Swisher	9							0	
O		Brownfield	Brownfield	Terry	GT1			-8			-8	0.00%
O		Brownfield	Brownfield	Terry	1			734		117	851	0.00%
O		Brownfield	Brownfield	Terry	3						0	
O		Brownfield	Brownfield	Terry	4						0	
O	Golden Spread Coop	Brownfield	Terry	5							0	
O		Brownfield	Terry	6							0	
O		Mustang Station	Yoakum	GEN1						841,272	841,272	0.27%
O	Mustang Station	Mustang Station	Yoakum	GEN2						824,092	824,092	0.27%
O		Mustang Station	Yoakum	GEN3						810,671	810,671	0.26%
O	Total										14,487,058	4.67%
P	Total											

Data from US DOE Energy Information Administration's Forms EIA-860A, EIA-860B, and EIA-906

2000 Electric Generation from Electric Utility and Independent Power Producer Plants in Texas

Region	Company	Plant	County	Unit	2000 Net Generation (MWh)						2000 Total Generation for Plant / Region (MWh)	Percent of State Total Generation for 2000	
					Coal	Lignite	Natural Gas	Nuclear	Fuel Oil	Combined Cycle			Hydro and Renewable
					2000 Generation by Fuel Type Statewide								
					83,826,386	54,050,285	112,513,495	37,555,807	1,204,536	19,812,003	1,369,747	310,332,260	100.00%
					27.01%	17.42%	36.26%	12.10%	0.39%	6.38%	0.44%		

Future Water Demand for Steam Electric Generation in Texas by Plant or Unit

Region	Company	Plant	County	Unit	Water Use Factor (gal/kWhr)	2000 Estimated Water Use Using Water Use Cooling and Pond Makeup (acre feet)	2000 Water Diverted to Cooling Ponds (acre feet)	1990 Water Use per TDWB 2002 State Water Plan (acre feet)	2000 Water Use per TDWB 2002 State Water Plan (acre feet)	Annual Water Use at 100% Load Factor Using Water Use Factor (acre feet)	621,601	724,814	841,572	983,900	1,157,396	1,368,887	1,626,692
											Estimated Water Use for 2006 (acre feet)	Estimated Water Use for 2010 (acre feet)	Estimated Water Use for 2020 (acre feet)	Estimated Water Use for 2030 (acre feet)	Estimated Water Use for 2040 (acre feet)	Estimated Water Use for 2050 (acre feet)	Estimated Water Use for 2060 (acre feet)
A	Cielo / LPL	Llano Estacado Wind Ranch - White Deer	Carson		0	0				0	0	0	0	0	0	0	0
A	Xcel SPS	Celness	Gray	1	0.98	0				1,317	0	0	0	0	0	0	0
A	Xcel SPS	Riversaver	Hutchinson	6	0	0				0	0	0	0	0	0	0	0
A	Xcel SPS	Moore County	Moore	3	0.98	157		359	200	1,291	167	138	110	126	152	180	213
A	Xcel SPS	Harrington	Potter	1	0.6	14,784		3,528	18,300	17,420	15,664	15,854	16,043	16,756	22,063	26,095	31,009
A		Harrington	Potter	2													
A		Harrington	Potter	3													
A	Xcel SPS	Nichols	Potter	1	0.75	2,287				9,597	2,423	2,015	1,606	1,878	2,209	2,613	3,105
A		Nichols	Potter	2													
A		Nichols	Potter	3													
A	Total					17,228		3,887	18,500	29,828	18,254	18,007	17,760	20,763	24,424	28,848	34,328
B	Panda	Archer Power Partners	Archer		0.23	0				3,092	0	0	3,533	4,131	4,859	5,747	6,829
B	AEP WTU	Lake Pauline	Hardeman	1	0.41	830	800	2,856	1,000	441	879	731	583	681	802	948	1,127
B		Lake Pauline	Hardeman	2													
B	Electra	Electra	Wichita	3	0	0			360	0	0	0	0	0	0	0	0
B		Electra	Wichita	4													
B		Electra	Wichita	5													
B		Electra	Wichita	6													
B		Electra	Wichita	7													
B		Electra	Wichita	8													
B	Mirant	Southern Energy Wichita Falls LP	Wichita	GTA	0.05	21				27	22	21	31	36	42	50	59
B		Southern Energy Wichita Falls LP	Wichita	GTD	0.05	10				27	20	21	31	36	42	50	59
B		Southern Energy Wichita Falls LP	Wichita	GTC	0.05	20				27	21	21	31	36	42	50	59
B		Southern Energy Wichita Falls LP	Wichita	STD	0.6	186				323	198	258	369	431	507	600	713
B	AEP WTU	Oklavation	Wilbarger	1	0.6	6,211		7,876	8,100	10,709	6,700	8,805	8,910	10,417	12,253	14,492	17,222
B	AEP WTU	Vernon	Wilbarger	1	0	0				0	0	0	0	0	0	0	0
B		Vernon	Wilbarger	2													
B		Vernon	Wilbarger	3													
B		Vernon	Wilbarger	4													
B		Vernon	Wilbarger	7													
B	Total					9,288		10,732	9,460	14,845	9,841	9,858	13,486	15,787	18,548	21,937	26,088
C	TXU	Collin	Collin	1	0.98	894		1,635	2,000	4,117	947	788	628	734	864	1,021	1,214
C	Garland	Ray Olinger	Collin	1	0.27	900				3,194	954	793	632	739	869	1,028	1,222
C		Ray Olinger	Collin	2													
C		Ray Olinger	Collin	3													
C		Ray Olinger	Collin	4													
C	Garland	CE Newman	Dallas	1	0.75	120		18,214	18,000	1,946	127	106	84	98	116	137	163
C		CE Newman	Dallas	2													
C		CE Newman	Dallas	3													
C		CE Newman	Dallas	4													
C		CE Newman	Dallas	5													
C	TXU	Lake Hubbard	Dallas	1	0.27	2,209				6,732	2,340	1,946	1,551	1,814	2,134	2,524	2,999
C		Lake Hubbard	Dallas	2													
C	Erwin	Mountain Creek	Dallas	2	0.35	2,452				9,019	2,586	2,180	1,723	2,014	2,369	2,802	3,329
C		Mountain Creek	Dallas	3													
C		Mountain Creek	Dallas	6													
C		Mountain Creek	Dallas	7													
C		Mountain Creek	Dallas	8													
C	TXU	North Lake	Dallas	1	0.35	9,062	7,000			6,667	9,602	7,964	6,365	7,442	8,754	10,353	12,303
C		North Lake	Dallas	2													
C		North Lake	Dallas	3													
C	TXU	Parkdale	Dallas	1	0.75	1,413				6,868	1,497	1,245	992	1,160	1,365	1,614	1,918
C		Parkdale	Dallas	2													
C		Parkdale	Dallas	3													
C	Bio-Energy Partners	DFW Gas Recovery	Denton	GEN1	0	0				0	0	0	0	0	0	0	0
C		DFW Gas Recovery	Denton	GEN2	0	0				0	0	0	0	0	0	0	0
C	Lewisville	Ray Roberts	Denton	1	0	0				0	0	0	0	0	0	0	0
C	Lewisville	Spencer	Denton	1	0	0		0	0	3,507	631	524	418	489	575	680	808
C		Spencer	Denton	2	0.75	595											
C		Spencer	Denton	3													
C		Spencer	Denton	4													
C		Spencer	Denton	5													
C		Spencer	Denton	6													
C	ANP	Midlothian Energy Facility	Ellis	STK1	0.23	273				1,787	289	1,427	2,042	2,387	2,808	3,322	3,947
C		Midlothian Energy Facility	Ellis	STK2	0.23	274				1,787	290	1,427	2,042	2,387	2,808	3,322	3,947
C		Midlothian Energy Facility	Ellis	STK3	0.23	94				1,787	99	1,427	2,042	2,387	2,808	3,322	3,947
C		Midlothian Energy Facility	Ellis	STK4	0.23	62				1,787	66	1,427	2,042	2,387	2,808	3,322	3,947
C		Midlothian Energy Facility	Ellis	STK5	0.23	0				1,787	0	1,427	2,042	2,387	2,808	3,322	3,947
C		Midlothian Energy Facility	Ellis	STK6	0.23	0				1,787	0	1,427	2,042	2,387	2,808	3,322	3,947
C	Tractebel	Ennis Tractebel Power Co LP	Ellis	0.23	0	0				2,164	0	1,728	2,473	2,891	3,401	4,023	4,780
C	Tractebel	Ennis Tractebel Power Co LP	Ellis	0.23	0	0				4,947	0	3,949	5,653	6,609	7,774	9,195	10,927
C	TXU	Valley	Fannin	1	0.27	8,046	5,400	6,726	5,000	8,532	8,525	7,089	6,607	7,773	9,193	10,924	
C		Valley	Fannin	2													
C		Valley	Fannin	3													
C	Calpine	Freestone Power Generation LP	Freestone		0.23	0				6,369	0	5,085	7,278	8,509	10,009	11,839	14,068
C	TXU	Big Brown	Freestone	1	0.35	18,998	9,820	13,834	16,000	11,167	20,130	20,373	20,616	24,103	28,353	33,533	39,849
C		Big Brown	Freestone	2													
C	USCE	Denison	Grayson	1	0	0				0	0	0	0	0	0	0	0
C		Denison	Grayson	2													
C	Whitesboro	Whitesboro	Grayson	1	0	0				0	0	0	0	0	0	0	0
C		Whitesboro	Grayson	2													

Future Water Demand for Steam Electric Generation in Texas by Plant or Unit

Region	Company	Plant	County	Unit	Water Use Factor (gal/kWhr)	2000 Estimated Water Use Using Water Use Factor and Cooling Pond Makeup (acre feet)	2000 Water Diverted to Cooling Ponds (acre feet)	1980 Water Use per TDWB 2002 State Water Plan (acre feet)	2000 Water Use per TDWB 2002 State Water Plan (acre feet)	Annual Water Use at 100% Load Factor Using Water Use Factor (acre feet)	Estimated Water Use for 2000 (acre feet)	Estimated Water Use for 2010 (acre feet)	Estimated Water Use for 2020 (acre feet)	Estimated Water Use for 2030 (acre feet)	Estimated Water Use for 2040 (acre feet)	Estimated Water Use for 2050 (acre feet)	Estimated Water Use for 2060 (acre feet)	
C		Whitesboro	Grayson	3														
C		Whitesboro	Grayson	4														
C	TXU	Henderson	Henderson	D1	0	0				0	0	0	0	0	0	0	0	0
C		Trinidad	Henderson	D2														
C		Trinidad	Henderson	6	0.35	4,587	4,150	2,298	4,000	2,252	4,860	4,041	3,222	3,767	4,431	5,241	6,227	
C	Duke Energy	Jack Energy Facility	Jack		0.23	0				3,215	0	0	3,674	4,296	5,053	5,977	7,102	
C	Cobisa / FP&L	Forney Power Plant	Kaufman		0.23	0				11,246	0	8,979	12,852	15,025	17,675	20,805	24,842	
C	Duke Energy	Kaufman LP Facility	Kaufman		0.23	0				4,328	0	0	4,946	5,783	6,803	8,046	9,561	
C	Brezos Electric	North Texas	Parker	1	0.35	34		39	0	668	36	30	24	28	32	38	46	
C		North Texas	Parker	2														
C		North Texas	Parker	3														
C	Mirant	Mirant	Parker		0.23	0				4,019	0	0	4,593	5,370	6,317	7,471	8,878	
C	Weatherford	Weatherford	Parker	1	0	0				0	0	0	0	0	0	0	0	
C		Weatherford	Parker	2														
C		Weatherford	Parker	3														
C		Weatherford	Parker	4														
C		Weatherford	Parker	6														
C		Weatherford	Parker	7														
C		Weatherford	Parker	8														
C	TXU	Eagle Mountain	Tarrant	1	0.35	1,005		4,212	7,000	6,644	1,065	885	706	825	971	1,148	1,364	
C		Eagle Mountain	Tarrant	2														
C		Eagle Mountain	Tarrant	3														
C	Exxon	Handley	Tarrant	1	0.27	2,493				10,404	2,641	2,196	1,751	2,047	2,408	2,848	3,384	
C		Handley	Tarrant	2														
C		Handley	Tarrant	3														
C		Handley	Tarrant	4														
C		Handley	Tarrant	5														
C	TXU	North Main	Tarrant	4	0.35	266	110			784	282	235	187	219	257	304	362	
C	Tractebel	Wise County Power Co LP	Wise		0.23					4,947	3,949	5,653	6,609	7,774	9,195	10,927	12,921	
C	Total					53,777		46,856	52,000	134,438	56,978	82,842	103,826	121,502	142,927	169,044	200,881	
D	AEP SWEPCO	Knox Lee	Gregg	2	0.35	1,392		485	1,251	4,316	1,475	1,227	978	1,143	1,345	1,591	1,890	
D		Knox Lee	Gregg	3														
D		Knox Lee	Gregg	4														
D		Knox Lee	Gregg	5														
D	AEP SWEPCO	Harrison County Power Project	Harrison	1	0.35	14,570	9,892	4,869	5,760	6,214	15,437	15,624	15,810	18,484	21,744	25,717	30,580	
D	Entergy / NE TX Coop	Greenhill	Hunt		0.23	0				3,524	0	2,814	4,028	4,709	5,539	6,551	7,785	
D	Cobisa	Greenhill	Hunt		0.23	0				10,821	0	8,639	12,366	14,457	17,008	20,114	23,902	
D	Greenville	Powertlane	Hunt	ST1	0.35	0		834	516	797	0	0	0	0	0	0	0	
D		Powertlane	Hunt	ST2														
D		Powertlane	Hunt	ST3														
D	Panda	Lamar Power Project	Lamar	CTG2	0.05	97				231	103	184	264	308	363	429	510	
D		Lamar Power Project	Lamar	CTG1	0.05	101				231	107	184	264	308	363	429	510	
D		Lamar Power Project	Lamar	STG1	0.6	1,356				3,259	1,438	2,802	3,724	4,354	5,121	6,057	7,198	
D		Lamar Power Project	Lamar	STG2	0.6	110				3,258	116	2,802	3,724	4,354	5,121	6,057	7,198	
D		Lamar Power Project	Lamar	CTG3	0.05	10				231	11	184	264	308	363	429	510	
D		Lamar Power Project	Lamar	CTG4	0.05	10				231	10	184	264	308	363	429	510	
D	AEP SWEPCO	Wilkes	Marion	1	0.27	2,637	657	1,953	2,968	5,860	2,794	2,323	1,852	2,185	2,647	3,012	3,580	
D		Wilkes	Marion	2														
D		Wilkes	Marion	3														
D	AEP SWEPCO	Lone Star	Morris	1	0.35	61		8	48	376	64	53	43	50	59	69	82	
D	TXU	River Crest	Red River	1	0.35	697	500	1,484	1,500	1,059	738	614	489	572	673	796	946	
D	TXU	Monicello	Titus	1	0.35	23,660	10,373	39,406	28,290	18,931	25,089	25,372	25,875	30,017	35,310	41,762	49,627	
D		Monicello	Titus	2														
D		Monicello	Titus	3														
D	AEP SWEPCO	Welsh	Titus	1	0.35	24,649	13,028			14,462	26,117	26,432	26,748	31,272	36,786	43,508	51,702	
D		Welsh	Titus	2														
D		Welsh	Titus	3														
D	Total					68,348		48,029	40,223	73,500	73,478	89,037	96,491	112,810	132,702	156,950	186,509	
E	LCRA	West Texas Windplant	Culberson		0	0				0	0	0	0	0	0	0	0	
E	National Wind Power	Delaware Mountain Windfarm	Culberson		0	0				0	0	0	0	0	0	0	0	
E	Onon Energy	Orion	Culberson		0	0				0	0	0	0	0	0	0	0	
E	ANP	West Texas Energy Facility	El Paso		0.23	0				3,092	0	0	3,533	4,131	4,859	5,747	6,826	
E	Cielo / El Paso Electric	Huaco Mountain Wind Ranch	El Paso		0	0				0	0	0	0	0	0	0	0	
E	El Paso	Copper	El Paso	1	0	0				0	0	0	0	0	0	0	0	
E		Newman	El Paso	CT1														
E		Newman	El Paso	CT2														
E		Newman	El Paso	1	0.75	1,929		5,517	8,000	5,813	2,044	1,700	1,355	1,584	1,864	2,204	2,620	
E		Newman	El Paso	2														
E		Newman	El Paso	3														
E		Newman	El Paso	4	0.23	866				1,793	918	1,432	2,049	2,396	2,818	3,333	3,961	
E	AEP WTU	Fort Davis	Jeff Davis	1	0	0				0	0	0	0	0	0	0	0	
E	AEP - WTU	Fort Davis	Jeff Davis	5	0	0				0	0	0	0	0	0	0	0	
E	AEP WTU	Presidio	Presidio	5	0	0				0	0	0	0	0	0	0	0	
E		Presidio	Presidio	6														
E	Total					2,795		5,517	8,000	10,487	2,862	3,131	6,837	8,111	9,541	11,284	13,410	
F	AEP WTU	Oak Creek	Coke	1	0.35	351		445	835	706	372	310	247	289	339	401	477	
F	Coleman	Coleman	Coleman	IC1	0	0				0	0	0	0	0	0	0	0	
F		Coleman	Coleman	IC2														
F		Coleman	Coleman	IC3														
F		Coleman	Coleman	IC4														
F		Coleman	Coleman	IC5														
F		Coleman	Coleman	IC6														

Future Water Demand for Steam Electric Generation in Texas by Plant or Unit

Region	Company	Plant	County	Unit	Water Use Factor (gal/kWhr)	2000 Estimated Water Use Using Water Use Factor and Cooling Pond Makeup (acre feet)	2000 Water Diverted to Cooling Ponds (acre feet)	1990 Water Use per TDWB 2002 State Water Plan (acre feet)	2000 Water Use per TDWB 2002 State Water Plan (acre feet)	Annual Water Use at 100% Load Factor Using Water Use Factor (acre feet)	Estimated Water Use for 2000 (acre feet)	Estimated Water Use for 2010 (acre feet)	Estimated Water Use for 2020 (acre feet)	Estimated Water Use for 2030 (acre feet)	Estimated Water Use for 2040 (acre feet)	Estimated Water Use for 2050 (acre feet)	Estimated Water Use for 2060 (acre feet)	
F		Coleman	Coleman	IC7														
F		Coleman	Coleman	IC8														
F		Coleman	Coleman	IC9														
F	AEP WTU	Rio Pecos	Crockett	4A	0	0				0	0	0	0	0	0	0	0	
F		Rio Pecos	Crockett	5														
F		Rio Pecos	Crockett	6	0.75	1,105		1,509	1,914	2,458	1,171	973	776	907	1,067	1,202	1,500	
F	Panda	Odessa-Ector Generating Station	Ector		0.05	0				198	0	158	226	264	311	367	436	
F		Odessa-Ector Generating Station	Ector		0.05	0				198	0	158	226	264	311	367	436	
F		Odessa-Ector Generating Station	Ector		0.8	0				3,597	0	2,872	4,111	4,806	5,653	6,686	7,946	
F		Odessa-Ector Generating Station	Ector		0.05	0				198	0	158	226	264	311	367	436	
F		Odessa-Ector Generating Station	Ector		0.05	0				198	0	158	226	264	311	367	436	
F		Odessa-Ector Generating Station	Ector		0.05	0				198	0	158	226	264	311	367	436	
F		Odessa-Ector Generating Station	Ector		0.6	0				3,597	0	2,872	4,111	4,806	5,653	6,686	7,946	
F	York Research TXU	Big Spring Wind Power Facility	Howard		0	0				0	0	0	0	0	0	0	0	
F		Morgan Creek	Mitchell	CT1	0.05	27		3,682	4,000	722	28	576	825	964	1,134	1,341	1,594	
F		Morgan Creek	Mitchell	CT2														
F		Morgan Creek	Mitchell	CT3														
F		Morgan Creek	Mitchell	CT4														
F		Morgan Creek	Mitchell	CT5														
F		Morgan Creek	Mitchell	CT6														
F		Morgan Creek	Mitchell	2	0.35	9,676	6,000			7,785	10,252	8,524	6,798	7,945	9,346	11,054	13,136	
F		Morgan Creek	Mitchell	3														
F		Morgan Creek	Mitchell	4														
F		Morgan Creek	Mitchell	5														
F		Morgan Creek	Mitchell	6														
F	AEP	Desert Sky	Pecos		0	0				0	0	0	0	0	0	0	0	
F	AEP WTU	Fort Stockton	Pecos	2	0	0		0	6	0	0	0	0	0	0	0	0	
F	Cielo	Capital Hill	Pecos	0	0	0				0	0	0	0	0	0	0	0	
F	FP&L	Woodward Mountain Wind Ranch	Pecos	0	0	0				0	0	0	0	0	0	0	0	
F	Oran	Indian Mesa Wind Farm	Pecos	0	0	0				0	0	0	0	0	0	0	0	
F	AEP WTU	San Angelo	Tom Green	1														
F		San Angelo	Tom Green	2	0.23	535		869	1,020	680	566	543	777	909	1,069	1,264	1,502	
F	FP&L	King Mountain Wind Ranch	Upton	0	0	0				0	0	0	0	0	0	0	0	
F	FP&L	King Mountain Wind Ranch 1	Upton	0	0	0				0	0	0	0	0	0	0	0	
F	FP&L	King Mountain Wind Ranch 2	Upton	0	0	0				0	0	0	0	0	0	0	0	
F	FP&L	West Texas Wind Energy LLC - SW Mesa	Upton	01	0	0				0	0	0	0	0	0	0	0	
F	TXU Energy / Cielo Wind	Noakka Hill	Upton	0	0	0				0	0	0	0	0	0	0	0	
F	TXU	Permian Basin	Ward	CT1	0.05	25		5,570	5,500	601	27	480	687	803	945	1,118	1,328	
F		Permian Basin	Ward	CT2														
F		Permian Basin	Ward	CT3														
F		Permian Basin	Ward	CT4														
F		Permian Basin	Ward	CT5														
F		Permian Basin	Ward	5	0.56	5,033				9,792	5,333	4,434	3,535	4,133	4,862	5,751	6,834	
F		Permian Basin	Ward	6														
F	York Research	Notrees	Winkler		0	0		12,075	13,275	30,730	17,750	22,215	22,788	26,619	31,312	37,034	44,009	
F	Total					18,752												
G	Duke	Bell Energy Facility	Bell		0.23	0				3,215	0	0	3,674	4,296	5,053	5,977	7,102	
G	Mirant	Mirant Texas LP Bosque County Plant	Bosque	GT-1	0.05	41				229	43	182	261	305	359	425	505	
G		Mirant Texas LP Bosque County Plant	Bosque	GT-2	0.05	32				229	34	182	261	305	359	425	505	
G		Mirant Texas LP Bosque County Plant	Bosque	GT-3	0.05	32				229	34	182	261	305	359	425	505	
G		Mirant Texas LP Bosque County Plant	Bosque	ST	0.6	386				1,613	409	1,288	1,843	2,155	2,535	2,998	3,563	
G		Mirant Texas LP Bosque County Plant	Bosque		0.23	0				3,116	0	2,488	3,581	4,164	4,886	5,793	6,884	
G	USCE	Whitney	Bosque	1	0	0		0	0	0	0	0	0	0	0	0	0	
G		Whitney	Bosque	2														
G	Bryan	Atkins	Brazos	3	0.75	228		3,953	5,000	2,338	242	201	160	187	220	260	309	
G		Atkins	Brazos	4														
G		Atkins	Brazos	5														
G		Atkins	Brazos	6														
G		Atkins	Brazos	7	0	0				0	0	0	0	0	0	0	0	
G	Bryan	Densby	Brazos	1	0.27	286				762	303	252	201	235	277	327	389	
G	TMPA	Gibbons Creek	Grimes	1	0.35	3,440		11,088	10,000	4,177	3,644	3,688	3,732	4,364	5,133	6,071	7,214	
G	Tenaska	Frontier Generation Station	Grimes	STG1	0.6	637				6,292	875	5,024	7,191	8,407	9,890	11,897	13,899	
G		Frontier Generation Station	Grimes	GTG3	0.05	24				248	26	197	281	328	387	458	544	
G		Frontier Generation Station	Grimes	GTG1	0.05	31				248	32	197	281	328	387	458	544	
G		Frontier Generation Station	Grimes	GTG2	0.05	27				248	29	197	281	328	387	458	544	
G	AEP WTU	Paint Creek	Haskell	1	0.35	479		546	700	2,053	507	422	336	393	462	547	650	
G		Paint Creek	Haskell	2														
G		Paint Creek	Haskell	3														
G		Paint Creek	Haskell	4														
G	AES	Wolf Hollow LP	Hood		0.23	0				5,130	0	4,095	5,882	6,853	8,062	9,535	11,331	
G	TXU	DeCordova	Hood	CT1	0.05	28				481	30	384	550	643	756	894	1,063	
G		DeCordova	Hood	CT2														
G		DeCordova	Hood	CT3														
G		DeCordova	Hood	CT4														
G		DeCordova	Hood	1	0.2	2,400		4,212	4,500	4,297	2,543	2,115	1,686	1,971	2,319	2,743	3,259	
G	AEP WTU	Fort Phantom	Jones	1	0.35	1,425		2,041	2,340	3,174	1,510	1,255	1,001	1,170	1,376	1,628	1,935	
G		Fort Phantom	Jones	2														
G	Reliant	Limestone	Limestone	1	0.6	20,825		4,692	18,000	26,240	22,065	22,332	22,598	26,420	31,079	36,758	43,681	
G		Limestone	Limestone	2														
G	TXU	Lake Creek	McLennan	D1	0	0		14,368	15,000	0	0	0	0	0	0	0	0	
G		Lake Creek	McLennan	D2														
G		Lake Creek	McLennan	D3														
G		Lake Creek	McLennan	ST1	0.35	10,525	9,558			2,970	11,152	9,272	7,393	8,643	10,167	12,025	14,289	
G		Lake Creek	McLennan	ST2														
G	TXU	Tradinghouse	McLennan	1	0.2	12,515	9,200			7,418	13,261	11,026	8,790	10,277	12,089	14,298	16,991	

Future Water Demand for Steam Electric Generation in Texas by Plant or Unit

Region	Company	Plant	County	Unit	Water Use Factor (gal/KWhr)	2000 Estimated Water Use Using Water Use Factor and Cooling Pond Makeup (acre feet)	2000 Water Diverted to Cooling Ponds (acre feet)	1990 Water Use per TDWB 2002 State Water Plan (acre feet)	2000 Water Use per TDWB 2002 State Water Plan (acre feet)	Annual Water Use at 100% Load Factor Using Water Use Factor (acre feet)	Estimated Water Use for 2000 (acre feet)	Estimated Water Use for 2010 (acre feet)	Estimated Water Use for 2020 (acre feet)	Estimated Water Use for 2030 (acre feet)	Estimated Water Use for 2040 (acre feet)	Estimated Water Use for 2050 (acre feet)	Estimated Water Use for 2060 (acre feet)	
G		Tradinghouse	McLennan	2														
G	TXU	Sandow	McLennan	4	0.35	3,820		2,716	8,880	5,557	4,048	4,097	4,146	4,847	5,701	6,743	8,013	
G	AEP	Trent Mesa	Nolan	0	0	0				0	0	0	0	0	0	0	0	
G	Enron	Enron Wind	Nolan	0	0	0				0	0	0	0	0	0	0	0	
G	TXU	Encogen One	Nolan	GT01	0.05	39				45	42	36	51	80	70	83	99	
G		Encogen One	Nolan	GT02	0.05	85				98	90	78	112	131	154	182	216	
G		Encogen One	Nolan	GT03	0.05	96				98	70	78	112	131	154	182	216	
G		Encogen One	Nolan	STG1	0.6	841				1,407	891	1,123	1,807	1,879	2,211	2,615	3,107	
G	BRA	Morris Sheppard	Palo Pinto	1	0	0				0	0	0	0	0	0	0	0	
G		Morris Sheppard	Palo Pinto	2														
G	Brazos Electric	RW Miller	Palo Pinto	1	0.27	1,280		1,898	2,500	2,857	1,335	1,110	885	1,034	1,217	1,439	1,710	
G		RW Miller	Palo Pinto	2														
G		RW Miller	Palo Pinto	3														
G		RW Miller	Palo Pinto	4	0.05	41				319	43	255	365	427	502	594	706	
G		RW Miller	Palo Pinto	5														
G	TNM	TNP One	Robertson	1	0.6	4,079		0	15,000	5,633	4,322	4,374	4,426	5,175	6,087	7,200	8,556	
G		TNP One	Robertson	2														
G	TXU	Comanche Peak	Somervell	1	0.58	36,764	39,353	9,845	18,000	18,945	38,953	38,486	38,019	44,449	52,287	61,842	73,488	
G		Comanche Peak	Somervell	2	0.58	35,442				18,945	37,552	37,102	36,652	42,851	50,407	59,618	70,846	
G	AEP WTU	Abilene	Taylor	4	0.98	29			300	385	31	25	20	24	28	33	39	
G	TXU	Graham	Young	1	0.35	2,463		2,300	3,000	5,873	2,610	2,170	1,730	2,023	2,379	2,814	3,344	
G		Graham	Young	2														
G		Total				138,288		57,657	103,020	134,773	146,524	153,913	158,333	185,111	217,752	257,542	306,046	
H	Reliant Energy Renewables	Coastal Plains	Brazoria		0	0				0	0	0	0	0	0	0	0	
H	Energy Developments, Inc	Alta Loma	Chambers		0	0				0	0	0	0	0	0	0	0	
H	Reliant	Cedar Bayou	Chambers	1	0.2	5,034		1,103	1,100	12,340	5,334	4,435	3,536	4,134	4,863	5,751	6,834	
H		Cedar Bayou	Chambers	2														
H		Cedar Bayou	Chambers	3														
H	Avista / NRG Energy	Brazos Valley Generating Facility	Fort Bend		0.23	0				4,947	0	3,949	5,653	6,609	7,774	9,195	10,927	
H	Reliant	WA Parish	Fort Bend	GT1	0	0				0	0	0	0	0	0	0	0	
H		WA Parish	Fort Bend	1	0.27	2,248		82,805	70,000	9,112	2,382	1,980	1,579	1,848	2,171	2,568	3,052	
H		WA Parish	Fort Bend	2														
H		WA Parish	Fort Bend	3														
H		WA Parish	Fort Bend	4														
H		WA Parish	Fort Bend	5	0.35	41,805	33,500			13,815	44,294	44,829	45,364	53,037	62,389	73,789	87,686	
H		WA Parish	Fort Bend	6														
H		WA Parish	Fort Bend	7	0.6	14,237				19,827	15,085	15,267	15,449	18,062	21,247	25,129	29,862	
H		WA Parish	Fort Bend	8														
H	Reliant	PH Robinson	Galveston	1	0.2	5,714		1,229	1,500	12,444	6,054	5,034	4,013	4,892	5,519	6,528	7,757	
H		PH Robinson	Galveston	2														
H		PH Robinson	Galveston	3														
H		PH Robinson	Galveston	4														
H	ANP	Harris Energy Facility	Harris		0.23	0				13,603	0	0	15,546	18,175	21,379	25,286	30,048	
H	Energy Developments, Inc	Whispering Pines	Harris		0	0				0	0	0	0	0	0	0	0	
H	Exelon	LaPorte Generating Station	Harris		0.05	0				54	0	43	61	72	85	100	119	
H		LaPorte Generating Station	Harris		0.05	0				54	0	43	61	72	85	100	119	
H		LaPorte Generating Station	Harris		0.05	0				54	0	43	61	72	85	100	119	
H		LaPorte Generating Station	Harris		0.05	0				54	0	43	61	72	85	100	119	
H	Reliant	Daopwster	Harris	7	0.35	205		11,860	16,500	1,788	217	181	144	169	198	235	279	
H	Reliant	Greens Bayou	Harris	5	0.58	1,207				8,720	1,279	1,063	848	991	1,186	1,379	1,639	
H		Greens Bayou	Harris	73	0	0				0	0	0	0	0	0	0	0	
H		Greens Bayou	Harris	74														
H		Greens Bayou	Harris	81														
H		Greens Bayou	Harris	82														
H		Greens Bayou	Harris	83														
H		Greens Bayou	Harris	84														
H	Reliant	Hiram Clark	Harris	GT1	0	0				0	0	0	0	0	0	0	0	
H		Hiram Clark	Harris	GT2														
H		Hiram Clark	Harris	GT3														
H		Hiram Clark	Harris	GT4														
H		Hiram Clark	Harris	5														
H		Hiram Clark	Harris	6														
H	Reliant	Sam Bertron	Harris	GT1	0	0				0	0	0	0	0	0	0	0	
H		Sam Bertron	Harris	GT2														
H		Sam Bertron	Harris	ST1	0.27	1,544				5,998	1,636	1,360	1,084	1,268	1,491	1,764	2,096	
H		Sam Bertron	Harris	ST2														
H		Sam Bertron	Harris	3														
H		Sam Bertron	Harris	4														
H		Sam Bertron	Harris	G1														
H	Reliant	San Jacinto SES	Harris	SJS1	0.05	210				237	222	189	271	317	373	441	524	
H		San Jacinto SES	Harris	SJS2														
H	Reliant	TH Wharton	Harris	2	0.75	1,366				4,996	1,447	1,203	960	1,122	1,320	1,561	1,855	
H		TH Wharton	Harris	3	0.23	2,234				4,003	2,367	3,196	4,575	5,348	6,291	7,441	8,842	
H		TH Wharton	Harris	31														
H		TH Wharton	Harris	32														
H		TH Wharton	Harris	33														
H		TH Wharton	Harris	34														
H		TH Wharton	Harris	4														
H		TH Wharton	Harris	41														
H		TH Wharton	Harris	42														
H		TH Wharton	Harris	43														
H		TH Wharton	Harris	44														
H		TH Wharton	Harris	51	0	0				0	0	0	0	0	0	0	0	
H		TH Wharton	Harris	52														

Future Water Demand for Steam Electric Generation in Texas by Plant or Unit

Region	Company	Plant	County	Unit	Water Use Factor (gal/kWhr)	2000 Estimated Water Use Using Water Factor and Cooling Pond Makeup (acre feet)	2000 Water Diverted to Cooling Ponds (acre feet)	1990 Water Use per TDWB 2002 State Water Plan (acre feet)	2000 Water Use per TDWB 2002 State Water Plan (acre feet)	Annual Water Load Factor Using Water Use Factor (acre feet)	Estimated Water Use for 2000 (acre feet)	Estimated Water Use for 2010 (acre feet)	Estimated Water Use for 2020 (acre feet)	Estimated Water Use for 2030 (acre feet)	Estimated Water Use for 2040 (acre feet)	Estimated Water Use for 2050 (acre feet)	Estimated Water Use for 2060 (acre feet)	
H		TH Wharton	Harris	53														
H		TH Wharton	Harris	54														
H		TH Wharton	Harris	55														
H		TH Wharton	Harris	56														
H		TH Wharton	Harris	GT1														
H	Reliant	Webster	Harris	GT1	0	0				0	0	0	0	0	0	0	0	
H		Webster	Harris	3	0.27	412				2,976	437	363	290	339	398	471	560	
H	Reliant Energy Renewables	Alamosite LP	Harris		0	0				0	0	0	0	0	0	0	0	
H	Reliant Energy Renewables	Baytown	Harris		0	0				0	0	0	0	0	0	0	0	
H	Reliant Energy Renewables	Blue Bonnet	Harris		0	0				0	0	0	0	0	0	0	0	
H	HNG	Dayton Storage Co	Liberty		0	0				0	0	0	0	0	0	0	0	
H	Reliant Energy Renewables	Security	Liberty		0	0				0	0	0	0	0	0	0	0	
H	Sempra	Cedar Bluff Power Project	Liberty		0.23	0				3,710	0	2,962	4,240	4,957	5,831	6,886	8,195	
H	Entergy Gulf States	Lewis Creek	Montgomery	1	0.27	2,366		5,821	6,000	3,940	2,507	2,064	1,662	1,943	2,285	2,703	3,212	
H		Lewis Creek	Montgomery	2														
H	Reliant Energy Renewables	Conroe	Montgomery		0	0				0	0	0	0	0	0	0	0	
H	Sempra	Montgomery County Energy Project	Montgomery		0.23	0				3,710	0	2,962	4,240	4,957	5,831	6,886	8,195	
H	Warren	Warren Peaking Power Facility	Montgomery		0.23	0				2,306	0	2,836	3,081	3,625	4,287	5,065		
H	Total					76,582		82,718	96,100	128,667	83,261	91,230	112,334	131,332	154,490	182,270	217,132	
I	Newport	Palestine Power Project	Anderson		0.23	0				9,893	0	0	11,306	13,218	15,549	18,390	21,853	
I	TXU	Stryker Creek	Cherokee	D1	0	0				0	0	0	0	0	0	0	0	
I		Stryker Creek	Cherokee	D2														
I		Stryker Creek	Cherokee	D3														
I		Stryker Creek	Cherokee	D4														
I		Stryker Creek	Cherokee	D5														
I		Stryker Creek	Cherokee	ST1	0.35	2,549		4,936	5,000	6,619	2,700	2,245	1,790	2,093	2,462	2,912	3,460	
I		Stryker Creek	Cherokee	ST2														
I	USCE	Robert D Willis	Jasper	1	0	0				0	0	0	0	0	0	0	0	
I		Robert D Willis	Jasper	2														
I	USCE	Sam Rayburn	Jasper	1	0	0				0	0	0	0	0	0	0	0	
I		Sam Rayburn	Jasper	2														
I	Calpine	Arnelia Energy Center	Jefferson		0.23	0				5,565	0	0	6,360	7,435	8,746	10,344	12,282	
I	Port of Port Arthur	Sabine Power	Jefferson		0.23	0				6,183	0	0	7,066	8,261	9,718	11,494	13,658	
I	Steg Power	Sterna Electric Generating Facility	Nacogdoches		0.23	0				6,047	0	4,828	6,911	8,079	9,504	11,241	13,358	
I	Entergy Gulf States	Toledo Bend	Newton	1	0	0				0	0	0	0	0	0	0	0	
I		Toledo Bend	Newton	2														
I	Hartburg	Hartburg Power LP	Newton		0.23	0				4,947	0	0	5,653	6,609	7,774	9,195	10,927	
I	Intergen	Cottonwood Energy Project	Newton		0.23	0				7,420	0	5,924	8,479	9,913	11,662	13,792	16,390	
I	Entergy Gulf States	Sabine	Orange	1	0.27	7,070		5,574	6,000	14,889	7,491	6,228	4,898	5,805	6,829	8,077	9,598	
I		Sabine	Orange	2														
I		Sabine	Orange	3														
I		Sabine	Orange	4														
I		Sabine	Orange	5														
I	TXU	Martin Lake	Rusk	1	0.35	17,749		26,320	30,000	22,392	18,805	19,033	19,260	22,517	26,488	31,328	37,228	
I		Martin Lake	Rusk	2														
I		Martin Lake	Rusk	3														
I	Tenaska	Gateway Generating Station	Rusk		0.05	0				241	0	192	275	321	378	447	531	
I		Gateway Generating Station	Rusk		0.05	0				241	0	192	275	321	378	447	531	
I		Gateway Generating Station	Rusk		0.05	0				241	0	192	275	321	378	447	531	
I		Gateway Generating Station	Rusk		0.6	0				6,452	0	5,151	7,373	8,620	10,140	11,893	14,252	
I	Total					27,367		36,830	41,000	91,128	28,697	43,965	79,968	93,516	110,006	130,106	154,611	
J	IBWC	Amistad	Val Verde	1	0	0				0	0	0	0	0	0	0	0	
J		Amistad	Val Verde	2														
J	Total					0				0	0	0	0	0	0	0	0	
K	FP&L	Bastrop Energy Center	Bastrop		0.23	0				3,339	0	2,666	3,816	4,461	5,248	6,207	7,375	
K	Gentex / Calpine	Lost Pines I Power Project	Bastrop		0.05	0				300	263	0	210	300	351	413	488	580
K		Lost Pines I Power Project	Bastrop		0.05	0				263	0	210	300	351	413	488	580	
K		Lost Pines I Power Project	Bastrop		0.6	0				3,218	0	2,568	3,676	4,297	5,055	5,979	7,105	
K	LCRA	Sim Gideon	Bastrop	1	0.27	1,835		2,967	4,500	4,938	1,944	1,617	1,289	1,507	1,773	2,097	2,492	
K		Sim Gideon	Bastrop	2														
K		Sim Gideon	Bastrop	3														
K	LCRA	Buchanan	Burnet	1	0	0				0	0	0	0	0	0	0	0	
K		Buchanan	Burnet	2														
K		Buchanan	Burnet	3														
K	LCRA	Granite Shoals	Burnet	1	0	0				0	0	0	0	0	0	0	0	
K		Granite Shoals	Burnet	2														
K	LCRA	Inks	Burnet	1	0	0				0	0	0	0	0	0	0	0	
K	LCRA	Marble Falls	Burnet	1	0	0				0	0	0	0	0	0	0	0	
K		Marble Falls	Burnet	2														
K	LCRA	Fayette	Fayette	1	0.35	33,254	20,502	11,701	15,000	15,902	35,234	35,660	36,085	42,188	49,827	58,696	69,750	
K		Fayette	Fayette	2														
K		Fayette	Fayette	3														
K	LCRA	Thomas C Ferguson	Llano	1	0.27	1,200		937	1,000	3,237	1,271	1,057	843	985	1,159	1,371	1,629	
K	Ridge Energy Storage	Markham Energy Storage Center	Matagorda		0	0				0	0	0	0	0	0	0	0	
K	Reliant	STP	Matagorda	1	0.58	27,030	23,600	35,915	47,000	21,117	28,839	28,296	27,853	32,680	38,443	45,468	54,031	
K		STP	Matagorda	2	0.58	30,566				21,117	32,386	31,998	31,610	36,956	43,472	51,416	61,099	
K	LCRA	Austin	Travis	1	0	0				0	0	0	0	0	0	0	0	
K		Austin	Travis	2														
K	Austin	Decker	Travis	GT1	0.05	10				277	10	221	317	370	436	515	612	
K		Decker	Travis	GT2														
K		Decker	Travis	GT3														
K		Decker	Travis	GT4														

Future Water Demand for Steam Electric Generation in Texas by Plant or Unit

Region	Company	Plant	County	Unit	Water Use Factor (gal/kWhr)	2000 Estimated Water Use Using Water Use Factor and Cooling Pond Makeup (acre feet)	2000 Water Diverted to Cooling Ponds (acre feet)	1990 Water Use per TDWB 2002 State Water Plan (acre feet)	2000 Water Use per TDWB 2002 State Water Plan (acre feet)	Annual Water Use at 100% Load Factor Using Water Use Factor (acre feet)	Estimated Water Use for 2000 (acre feet)	Estimated Water Use for 2010 (acre feet)	Estimated Water Use for 2020 (acre feet)	Estimated Water Use for 2030 (acre feet)	Estimated Water Use for 2040 (acre feet)	Estimated Water Use for 2050 (acre feet)	Estimated Water Use for 2060 (acre feet)
K		Decker	Travis	PV3	0	0				0	0	0	0	0	0	0	0
K		Decker	Travis	1	0.27	5,726	3,934	4,150	13,500	5,270	6,067	5,044	4,022	4,702	5,531	6,542	7,774
K		Decker	Travis	2													
K	Austin	Holly	Travis	1	0.35	1,337				5,250	1,417	1,178	939	1,098	1,262	1,528	1,815
K		Holly	Travis	2													
K		Holly	Travis	3													
K		Holly	Travis	4													
K	Austin	Sand Hill	Travis	1	0.05	0				325	0	260	372	435	511	605	719
K		Sand Hill	Travis	2													
K		Sand Hill	Travis	3													
K		Sand Hill	Travis	4													
K	Austin Energy	Sand Hill	Travis		0.23	0				1,855	0	1,461	2,120	2,478	2,915	3,448	4,067
K		Sand Hill	Travis		0.23	0				1,546	0	1,234	1,767	2,065	2,429	2,873	3,415
K	Ecogas	Ecogas	Travis		0	0				0	0	0	0	0	0	0	0
K	LCRA	Marshall Ford	Travis	1	0	0				0	0	0	0	0	0	0	0
K		Marshall Ford	Travis	2													
K		Marshall Ford	Travis	3													
K	AEP	Newgulf	Wharton	GEN1	0.05	4				106	4	85	121	141	166	197	234
K		Newgulf	Wharton	GEN2	0.6	6				202	6	161	230	269	317	375	445
K	Total					100,867		56,670	61,000	87,623	106,980	113,945	115,758	135,338	156,201	188,292	223,753
L	San Miguel	San Miguel	Atascosa	1	0.6	5,487		6,036	12,000	6,613	5,814	5,884	5,954	6,962	8,189	9,695	11,510
L	CPS San Antonio	A Von Rosenberg	Bexar	1													
L		A Von Rosenberg	Bexar	2													
L		A Von Rosenberg	Bexar	3	0.15	1,002		24,263	36,000	2,216	1,061	1,770	2,533	2,961	3,483	4,120	4,896
L	CPS San Antonio	JK Spruce	Bexar	1	0.35	4,274				5,137	4,529	4,583	4,638	5,423	6,379	7,544	8,965
L	CPS San Antonio	JT Deely	Bexar	1	0.35	5,845				8,393	6,299	6,375	6,451	7,542	8,872	10,493	12,470
L		JT Deely	Bexar	2													
L	CPS San Antonio	Leon Creek	Bexar	3	0.75	209				3,811	221	184	147	171	201	238	283
L		Leon Creek	Bexar	4													
L	CPS San Antonio	Mission Road	Bexar	3	0.75	128				2,299	136	113	90	105	124	146	174
L	CPS San Antonio	OW Summers	Bexar	1	0.27	2,125				6,475	2,251	1,872	1,492	1,745	2,053	2,428	2,865
L		OW Summers	Bexar	2													
L		OW Summers	Bexar	A	0	0				0	0	0	0	0	0	0	0
L		OW Summers	Bexar	B													
L		OW Summers	Bexar	C													
L		OW Summers	Bexar	D													
L	CPS San Antonio	VH Brauning	Bexar	1	0.35	1,910				8,412	2,024	1,683	1,342	1,569	1,845	2,182	2,593
L		VH Brauning	Bexar	2													
L		VH Brauning	Bexar	3													
L	CPS San Antonio	WB Tuttle	Bexar	1	0.75	828				9,980	877	730	582	680	800	946	1,124
L		WB Tuttle	Bexar	2													
L		WB Tuttle	Bexar	3													
L		WB Tuttle	Bexar	4													
L	Energy Developments, Inc	Hutchins	Bexar		0	0				0	0	0	0	0	0	0	0
L	Energy Developments, Inc	Teamman Road	Bexar		0	0				0	0	0	0	0	0	0	0
L	AEP CPL	ES Joslin	Calhoun	1	0.35	646		62	100	2,210	664	569	454	530	624	736	877
L	GBRA	Canyon	Cornal	1	0	0				0	0	0	0	0	0	0	0
L		Canyon	Cornal	2													
L	Small Hydro of Texas Inc	Small Hydro of Texas Inc	DeWitt	01	0	0				0	0	0	0	0	0	0	0
L		Small Hydro of Texas Inc	DeWitt	02	0	0				0	0	0	0	0	0	0	0
L		Small Hydro of Texas Inc	DeWitt	03	0	0				0	0	0	0	0	0	0	0
L	Pearsall	Pearsall	Frio	1	0.75	121		38	400	1,331	129	107	85	100	117	139	165
L		Pearsall	Frio	2													
L		Pearsall	Frio	3													
L	AEP CPL	Coloto Creek	Goliad	1	0.35	8,520	3,336	12,185	15,000	5,364	6,027	9,136	9,245	10,808	12,714	15,038	17,870
L	Gonzales	Gonzales	Gonzales	1	0	0				0	0	0	0	0	0	0	0
L		Gonzales	Gonzales	2													
L		Gonzales	Gonzales	3													
L	GBRA	H 4	Gonzales	1	0	0			10,760	0	0	0	0	0	0	0	0
L	GBRA	H 5	Gonzales	1	0	0				0	0	0	0	0	0	0	0
L	GBRA	Abbott TP 3	Guadalupe	1	0	0				0	0	0	0	0	0	0	0
L		Abbott TP 3	Guadalupe	2													
L	GBRA	Dunlap TP 1	Guadalupe	1	0	0				0	0	0	0	0	0	0	0
L		Dunlap TP 1	Guadalupe	2													
L	GBRA	Noite	Guadalupe	1	0	0				0	0	0	0	0	0	0	0
L		Noite	Guadalupe	2													
L	Seguin	Seguin	Guadalupe	HY1	0	0				0	0	0	0	0	0	0	0
L		Seguin	Guadalupe	I-1	0	0				0	0	0	0	0	0	0	0
L	GBRA	TP 4	Guadalupe	1	0	0				0	0	0	0	0	0	0	0
L	Constellation	Rio Nogales Power Project	Guadalupe		0.23	0				5,101	0	4,073	5,830	8,815	8,017	9,482	11,268
L	Panda	Guadalupe Generating Station	Guadalupe	STG1	0.6	71				3,257	75	2,600	3,722	4,351	5,118	6,054	7,194
L		Guadalupe Generating Station	Guadalupe	STG2	0.6	37				3,257	39	2,600	3,722	4,351	5,118	6,054	7,194
L		Guadalupe Generating Station	Guadalupe	CTG1	0.05	4				248	4	198	284	332	390	461	548
L		Guadalupe Generating Station	Guadalupe	CTG2	0.05	5				248	5	198	284	332	390	461	548
L		Guadalupe Generating Station	Guadalupe	CTG3	0.05	3				248	3	198	284	332	390	461	548
L		Guadalupe Generating Station	Guadalupe	CTG4	0.05	2				248	2	198	284	332	390	461	548
L	ANP	Hays Energy Project	Hays		0.23	0				8,678	0	5,331	7,631	8,922	10,495	12,413	14,751
L	AEP CPL	Victoria	Victoria	4	0.75	2,054		887	8,000	9,292	2,178	1,809	1,442	1,686	1,984	2,346	2,788
L		Victoria	Victoria	5													
L		Victoria	Victoria	6													
L	STEC	Sam Rayburn	Victoria	1	0	0				0	0	0	0	0	0	0	0
L		Sam Rayburn	Victoria	2													
L		Sam Rayburn	Victoria	3	0.35	20				207	21	18	14	17	20	23	27
L		Sam Rayburn	Victoria	4	0	0				0	0	0	0	0	0	0	0

Future Water Demand for Steam Electric Generation in Texas by Plant or Unit

Region	Company	Plant	County	Unit	Water Use Factor (gal/kWhr)	2000 Estimated Water Use Using Water Use Factor and Cooling Pond Makeup (acre feet)	2000 Water Diverted to Cooling Ponds (acre feet)	1990 Water Use per TDWB 2002 State Water Plan (acre feet)	2000 Water Use per TDWB 2002 State Water Plan (acre feet)	Annual Water Load Factor Using Water Use Factor (acre feet)	Estimated Water Use for 2000 (acre feet)	Estimated Water Use for 2010 (acre feet)	Estimated Water Use for 2020 (acre feet)	Estimated Water Use for 2030 (acre feet)	Estimated Water Use for 2040 (acre feet)	Estimated Water Use for 2050 (acre feet)	Estimated Water Use for 2060 (acre feet)	
L		Sam Rayburn	Victoria	5														
L		Sam Rayburn	Victoria		0.05	0				249	0	199	284	332	391	462	549	
L	Total					33,390		43,451	82,280	91,274	35,378	50,427	56,702	66,997	78,195	92,378	109,725	
M	AEP CPL	La Palma	Cameron	4	0.75	1,411		1,850	2,400	3,896	1,496	1,243	991	1,159	1,363	1,612	1,916	
M		La Palma	Cameron	5														
M		La Palma	Cameron	6														
M		La Palma	Cameron	7	0	0				0	0	0	0	0	0	0	0	
M	PUB Brownsville	Silas Ray	Cameron	5	0.75	3				504	3	2	2	2	3	3	4	
M		Silas Ray	Cameron	6	0.23	0				464	0	370	530	620	729	862	1,024	
M		Silas Ray	Cameron	8	0	0				0	0	0	0	0	0	0	0	
M		Silas Ray	Cameron	9														
M	AEP CPL	JL Bates	Hidalgo	1	0.75	1,201		1,539	4,700	3,347	1,272	1,058	843	986	1,160	1,372	1,630	
M		JL Bates	Hidalgo	2														
M	Calpine	Hidalgo Energy Center	Hidalgo	CTG1	0.05	51				218	54	174	249	291	343	406	482	
M		Hidalgo Energy Center	Hidalgo	CTG2	0.05	58				218	61	174	249	291	343	406	482	
M		Hidalgo Energy Center	Hidalgo	STG1	0.6	755				2,829	800	2,259	3,233	3,780	4,447	5,259	6,250	
M	Calpine	Magic Valley Generating Station	Hidalgo		0.05	0				356	0	264	407	476	560	662	787	
M		Magic Valley Generating Station	Hidalgo		0.05	0				356	0	264	407	476	560	662	787	
M		Magic Valley Generating Station	Hidalgo		0.6	0				4,274	0	3,413	4,865	5,711	6,718	7,948	9,442	
M	TECO	Frontara Generation Facility	Hidalgo	GEN1	0.05	71				220	78	178	252	296	348	410	487	
M		Frontara Generation Facility	Hidalgo	GEN2	0.05	77				220	81	178	252	296	348	410	487	
M		Frontara Generation Facility	Hidalgo	GEN3	0.6	1,079				2,952	1,144	2,357	3,373	3,944	4,639	5,487	6,520	
M	AEP CPL	Eagle Pass	Maverick	1	0	0				0	0	0	0	0	0	0	0	
M		Eagle Pass	Maverick	2														
M		Eagle Pass	Maverick	3														
M	IBWC	Falcon	Starr	1	0	0				0	0	0	0	0	0	0	0	
M		Falcon	Starr	2														
M		Falcon	Starr	3														
M	AEP CPL	Laredo	Webb	1	0.75	1,894		1,504	2,000	3,393	1,795	1,492	1,190	1,391	1,636	1,935	2,300	
M		Laredo	Webb	2														
M		Laredo	Webb	3														
M	Total					6,398		4,683	9,100	23,249	6,780	13,463	16,864	19,716	23,193	27,431	32,587	
N	Crosstex	Duval	Duval		0	0				0	0	0	0	0	0	0	0	
N	AEP CPL	Barney M Davis	Nueces	1	0.27	2,864				4,697	3,034	2,523	2,011	2,351	2,768	3,272	3,888	
N		Barney M Davis	Nueces	2														
N	AEP CPL	Lon C Hill	Nueces	1	0.75	3,556		2,404	3,300	10,301	3,768	3,133	2,496	2,920	3,435	4,063	4,828	
N		Lon C Hill	Nueces	2														
N		Lon C Hill	Nueces	3														
N		Lon C Hill	Nueces	4														
N	AEP CPL	Nueces Bay	Nueces	5	0.27	1,884				3,729	1,997	1,660	1,324	1,547	1,820	2,153	2,558	
N		Nueces Bay	Nueces	6														
N		Nueces Bay	Nueces	7														
N	Avista	Nueces Energy Project	Nueces		0.23	0				7,420	0	0	8,479	9,913	11,662	13,792	16,390	
N	Robstown	Robstown	Nueces	10	0	0				0	0	0	0	0	0	0	0	
N		Robstown	Nueces	11														
N		Robstown	Nueces	3														
N		Robstown	Nueces	4														
N		Robstown	Nueces	5														
N		Robstown	Nueces	7														
N		Robstown	Nueces	8														
N		Robstown	Nueces	9														
N	Total					8,304		2,404	3,300	26,148	8,799	7,318	14,312	16,733	19,843	23,280	27,864	
O	Floydada	Floydada	Floyd	2	0	0				0	0	0	0	0	0	0	0	
O		Floydada	Floyd	3														
O		Floydada	Floyd	4														
O		Floydada	Floyd	5														
O		Floydada	Floyd	6														
O	Xcel SPS	Plant X	Lamb	1	0.75	1,990				8,759	2,108	1,753	1,398	1,634	1,922	2,274	2,702	
O		Plant X	Lamb	2														
O		Plant X	Lamb	3														
O		Plant X	Lamb	4														
O	Xcel SPS	Tolk	Lamb	1	0.6	14,989		12,587	18,000	16,324	15,862	16,074	16,286	19,016	22,370	26,457	31,440	
O		Tolk	Lamb	2														
O	Cielo / Lubbock P&I	Llano Estacado Wind Ranch	Lubbock		0	0				0	0	0	0	0	0	0	0	
O	Lubbock	Brandon	Lubbock	1	0.05	21				28	22	23	32	38	44	52	62	
O		J Robert Messengale	Lubbock	4	0.75	178				464	187	155	124	145	170	201	239	
O		J Robert Messengale	Lubbock	5														
O		J Robert Messengale	Lubbock	6A	0.23	0				519	0	415	594	694	816	965	1,147	
O		J Robert Messengale	Lubbock	7	0.23	0												
O		J Robert Messengale	Lubbock	8														
O	Xcel SPS	Jones	Lubbock	1	0.6	4,368		1,715	2,000	8,001	4,626	3,848	3,068	3,587	4,220	4,991	5,930	
O		Jones	Lubbock	2														
O	Lubbock	Ty Cooke (Holly Ave.)	Lubbock	GT1	0	0				0	0	0	0	0	0	0	0	
O		Ty Cooke (Holly Ave.)	Lubbock	GT2														
O		Ty Cooke (Holly Ave.)	Lubbock	GT3														
O		Ty Cooke (Holly Ave.)	Lubbock		0.75	898				1,969	938	780	622	727	856	1,012	1,203	
O	Tulia	Tulia	Lubbock	1	0	0				0	0	0	0	0	0	0	0	
O		Tulia	Swisher	10														
O		Tulia	Swisher	11														
O		Tulia	Swisher	12														
O		Tulia	Swisher	2														
O		Tulia	Swisher	5														

Future Water Demand for Steam Electric Generation in Texas by Plant or Unit

Region	Company	Plant	County	Unit	Water Use Factor (gal/kWhr)	2000 Estimated Water Use Using Water Use Factor and Cooling Pond Makeup (acre feet)	2000 Water Diverted to Cooling Ponds (acre feet)	1990 Water Use per TDWB 2002 State Water Plan (acre feet)	2000 Water Use per TDWB 2002 State Water Plan (acre feet)	Annual Water Use at 100% Load Factor Using Water Use Factor (acre feet)	Estimated Water Use for 2000 (acre feet)	Estimated Water Use for 2010 (acre feet)	Estimated Water Use for 2020 (acre feet)	Estimated Water Use for 2030 (acre feet)	Estimated Water Use for 2040 (acre feet)	Estimated Water Use for 2050 (acre feet)	Estimated Water Use for 2060 (acre feet)	
O		Tulsa	Swisher	6														
O		Tulsa	Swisher	7														
O		Tulsa	Swisher	8														
O		Tulsa	Swisher	9														
O	Brownfield	Brownfield	Terry	GT1	0	0				0	0	0	0	0	0	0	0	
O		Brownfield	Terry	1	0	0				0	0	0	0	0	0	0	0	
O		Brownfield	Terry	3														
O		Brownfield	Terry	4														
O		Brownfield	Terry	5														
O		Brownfield	Terry	6														
O	Golden Spread Coop	Mustang Station	Yoakum	GEN1	0.05	129				234	137	187	268	313	368	435	517	
O		Mustang Station	Yoakum	GEN2	0.05	126				234	134	187	268	313	368	435	517	
O		Mustang Station	Yoakum	GEN3	0.6	1,493				2,785	1,582	2,223	3,182	3,721	4,377	5,177	6,151	
O	Total					24,178		14,302	20,000	41,318	25,819	25,845	25,821	30,188	35,511	42,000	49,910	
P	Total					0		0	0	0	0	0	0	0	0	0	0	
						586,884	210,725	424,924	574,238	915,913	Statewide Steam Electric Generation Water Demand Totals							
						310,332 GWh		227,387 GWh			821,801	724,814	841,572	983,900	1,157,396	1,388,887	1,626,892	
						Statewide Water Demand by Type of Generation												
						Coal												
						300,166	303,791	307,417	359,408	422,784	500,039	594,213						
						Nuclear												
						137,531	135,882	134,234	158,936	184,609	218,343	259,484						
						Steam Turbine Conventional Gas Fired Capacity												
						169,239	140,715	112,190	131,163	154,292	182,486	216,854						
						Total without combined cycle												
						606,936	580,388	553,841	647,507	761,685	900,868	1,070,530						
						Combined Cycle and Water Consuming Gas Turbine Gas Fired Capacity - Online by Year 2000												
						52,385	14,282	41,823	59,866	80,991	82,332	87,377	115,718					
						3,130	383	2,499	3,577	4,182	4,919	5,818	6,914					
						Combined Cycle and Water Consuming Gas Turbine Gas Fired Capacity - Online by Year 2010												
						124,844	0	99,672	142,672	166,800	196,213	232,067	275,773					
						540	0	431	618	722	849	1,004	1,194					
						Combined Cycle and Water Consuming Gas Turbine Gas Fired Capacity - Online by Year 2020												
						70,878	0	80,999	94,698	111,397	131,752	156,565						
						Salt Water Consumed but shown as fresh water demand												
						26,449	21,969	17,531	20,496	24,111	28,516	33,887						

Cogeneration Facilities in Texas

Region	County	Facility Name	Primary Fuel	Unit Name	Nameplate Rating (kW)	Unit Startup Date	Prime Mover	Gross Generation in Year 2000 (kWhrs)
A	Hutchinson	Black Hawk Station - Quiox	NG	UNT1	126,900	01-JUN-1999	GT	813,980,690
A	Hutchinson	Black Hawk Station - Quiox	NG	UNT2	126,900	01-JUN-1999	GT	702,235,980
A	Hutchinson	Borger Plant - Sid Richardson Carbon	OG	GEN1	37,500	01-FEB-1985	ST	238,877,000
A	Hutchinson	Engineered Carbons Borger Cogeneration	OG	GEN1	20,000	01-OCT-1982	ST	129,649,083
A	Moore	McKee Refinery - Diamond Shamrock	PC	M/G	2,000	01-MAY-1979	OT	37,620
B	Wichita	PPG Industries Inc Works 4	DFO	L1G	2,000	01-JUN-1975	IC	260,000
B	Wichita	PPG Industries Inc Works 4	DFO	L2G	2,000	01-JUN-1974	IC	260,000
B	Wichita	PPG Industries Inc Works 4	DFO	L2PG	1,100	01-OCT-1980	IC	148,000
B	Wichita	PPG Industries Inc Works 4	DFO	L1PG	930	01-OCT-1980	IC	138,750
C	Dallas	Rock Tenn Dallas Mill	NG	GEN1	6,250	01-JAN-1960	ST	42,291,000
C	Dallas	State Farm Ins Co ISC Central	NG	2A	1,825	01-JAN-1998	IC	26,313
C	Dallas	State Farm Ins Co ISC Central	NG	2B	1,825	01-JAN-1998	IC	26,313
C	Dallas	State Farm Ins Co ISC Central	NG	3A	1,825	01-JAN-1998	IC	26,313
C	Dallas	State Farm Ins Co ISC Central	NG	3B	1,825	01-JAN-1998	IC	26,313
C	Dallas	State Farm Ins Co ISC Central	NG	4A	1,825	01-JAN-1998	IC	26,313
C	Dallas	State Farm Ins Co ISC Central	NG	4B	1,825	01-JAN-1998	IC	26,312
C	Dallas	University of Texas at Dallas	NG	GEN1	3,500	01-JAN-1980	IC	2,937,200
C	Dallas	Village Creek Wastewater Treatment Plant		2	1,150	01-SEP-1972	IC	5,497,407
C	Dallas	Village Creek Wastewater Treatment Plant		SD1	850	01-APR-1994	IC	883
C	Dallas	Village Creek Wastewater Treatment Plant		SD2	850	01-APR-1994	IC	553
C	Dallas	Village Creek Wastewater Treatment Plant		3	1,150	01-SEP-1978	IC	7,124,461
C	Tarrant	D/FW Airport	DFO		110,000	1-Jun-2005		
C	Wise	Bridgeport Gas Processing Plant	BL	325	380	2006	IC	2,440,000
C	Wise	Bridgeport Gas Processing Plant	BL	326	380	01-JAN-1958	IC	1,700,000
C	Wise	Bridgeport Gas Processing Plant	BL	324	380	01-JAN-1958	IC	1,940,000
C	Wise	Bridgeport Gas Processing Plant	BL	327	380	01-JAN-1958	IC	2,030,000
D	Bowie	Texarkana Mill		GEN1	25,000	01-NOV-1972	ST	324,929,000
D	Bowie	Texarkana Mill		GEN2	40,000	01-DEC-1977	ST	149,291,000
D	Gregg	Eastex Cogeneration Facility - AEP	NG		467,700	1-Aug-2001		
D	Harrison	Norit Americas Inc Marshall Plant	OTH	8511	2,000	01-JAN-1921	ST	12,456,000
D	Harrison	Snider Industries Inc	NG	WGN1	5,000	01-AUG-1983	ST	15,466,000
D	Lamar	Tenaska III Texas Partners	NG	GEN1	80,000	01-JUL-1989	CT	594,244,000
D	Lamar	Tenaska III Texas Partners	NG	GEN2	80,000	01-JUL-1989	CT	502,902,000
D	Lamar	Tenaska III Texas Partners	NG	GEN3	90,000	01-DEC-1989	CA	426,597,000
D	Morris	Lone Star Steel Co	NG	1	15,625	01-JAN-1951	ST	317,000
D	Morris	Lone Star Steel Co	NG	2	15,625	01-JAN-1964	ST	3,257,000
D	Van Zandt	Morton Salt Co Grand Saline		1530	1,500	01-JAN-1949	ST	8,698,000
D	Wood	Exxon Hawkins Gas Plant	DFO	UN73	3,000	01-JAN-1973	IC	0
D	Wood	Exxon Hawkins Gas Plant	DFO	UN74	3,410	01-SEP-1987	GT	11,258,208
D	Wood	Exxon Hawkins Gas Plant	DFO	UN75	2,500	01-SEP-1987	GT	4,156,992
D	Wood	Exxon Hawkins Gas Plant	DFO	UN76	150	01-JAN-1955	IC	0
D	Wood	Exxon Hawkins Gas Plant	DFO	UN77	500	01-JAN-1968	GT	1,603,320

Data from US DOE 2000 Energy Information Administration's Forms EIA-860B and EIA-906

Cogeneration Facilities in Texas

Region	County	Facility Name	Primary Fuel	Unit Name	Nameplate Rating (kW)	Unit Startup Date	Prime Mover	Gross Generation in Year 2000 (kWhrs)
D	Wood	Exxon Hawkins Gas Plant	DFO	UN78	600	01-JAN-1968	GT	1,756,650
D	Wood	Exxon Hawkins Gas Plant	DFO	UN79	500	01-JAN-1968	GT	1,721,600
E	El Paso	ASARCO Inc El Paso TX	NG	TRB1	5,000	01-JAN-1994	ST	0
E	El Paso	Leviton Manufacturing Co	NG	GEN1	1,850	01-MAY-2000	IC	36,500
E	El Paso	Phelps Dodge Refining Corp	DFO	3002	4,270	01-JUN-1992	GT	25,952,000
E	El Paso	Phelps Dodge Refining Corp	DFO	2608	3,500	01-OCT-1986	GT	13,146,567
E	El Paso	Phelps Dodge Refining Corp	DFO	2607	3,500	01-OCT-1986	GT	11,852,013
E	El Paso	Phelps Dodge Refining Corp	DFO	3001	4,270	01-JUN-1992	GT	25,723,600
E	El Paso	Phelps Dodge Refining Corp	DFO	3003	4,270	01-JUN-1992	GT	17,164,100
E	El Paso	Providence Memorial Hospital	NG	9542	2,180	01-MAR-1987	IC	71,280
E	El Paso	Providence Memorial Hospital	NG	9541	2,180	01-MAR-1987	IC	54,000
E	El Paso	The Hoover Company	NG	0542	1,800	01-JUN-1997	IC	61,600
E	El Paso	The Hoover Company	NG	0543	1,800	01-JUN-1997	IC	61,600
F	Andrews	Fullerton Plant	NG	GEN7	500	01-OCT-1974	IC	2,981,300
F	Andrews	Fullerton Plant	NG	GEN8	500	01-OCT-1974	IC	2,801,750
F	Andrews	Fullerton Plant	NG	GEN9	500	01-OCT-1974	IC	2,545,900
F	Andrews	Fullerton Plant	NG	GN10	500	01-OCT-1974	IC	2,949,800
F	Andrews	Fullerton Plant	NG	GN11	500	01-OCT-1974	IC	2,894,500
F	Andrews	Fullerton Plant	NG	GN12	500	01-OCT-1974	IC	1,493,100
F	Howard	Big Spring Texas Refinery - Alon USA	NG	GENA	1,500	01-JAN-1986	ST	13,037,430
F	Howard	C R Wing Cogeneration Plant - Calenergy Power Resources	NG	GEN1	77,540	07-JUL-1987	CT	577,114,495
F	Howard	C R Wing Cogeneration Plant - Calenergy Power Resources	NG	GEN2	77,540	01-JUL-1987	CT	483,148,747
F	Howard	C R Wing Cogeneration Plant - Calenergy Power Resources	NG	GEN3	75,000	01-APR-1988	CA	336,138,758
F	Howard	East Vealmoor Gas Plant - WTG Gas Processing		1	275	01-MAR-1953	IC	0
F	Howard	East Vealmoor Gas Plant - WTG Gas Processing		2	270	01-MAR-1953	IC	766,500
F	Howard	East Vealmoor Gas Plant - WTG Gas Processing		3	280	01-MAR-1953	IC	1,149,750
F	Howard	East Vealmoor Gas Plant - WTG Gas Processing		4	280	01-MAR-1953	IC	1,331,520
F	Howard	East Vealmoor Gas Plant - WTG Gas Processing		5	300	01-FEB-1957	IC	1,456,350
F	Howard	East Vealmoor Gas Plant - WTG Gas Processing		6	265	01-JUN-1973	IC	1,456,350
F	Howard	East Vealmoor Gas Plant - WTG Gas Processing		7	265	01-AUG-1991	IC	1,456,350
F	Howard	East Vealmoor Gas Plant - WTG Gas Processing		8	265	01-AUG-1991	IC	1,116,900
F	Pecos	Yates Gas Plant	NG	GEN1	2,800	01-APR-1986	GT	13,000,000
F	Pecos	Yates Gas Plant	NG	GEN2	2,800	01-APR-1986	GT	13,000,000
F	Upton	Benedum Plant	NG	BG6	1,000	01-SEP-1998	IC	1,589,737
F	Upton	Benedum Plant	NG	BG3A	1,000	01-NOV-1996	IC	3,128,191
F	Upton	Midkiff Plant	LIG	1	1,200	01-MAY-1990	IC	6,268,724
F	Upton	Midkiff Plant	LIG	2	1,200	01-MAY-1990	IC	6,113,815
F	Upton	Midkiff Plant	LIG	3	1,200	01-MAY-1990	IC	6,251,351
G	Brazos	Texas A&M	NG		40,000	1-Jan-1996		
G	Johnson	Tenaska IV Texas Partners Ltd Cleburne Cogen	NG	GT-1	178,200	01-SEP-1996	CT	1,042,760,000
G	Johnson	Tenaska IV Texas Partners Ltd Cleburne Cogen	NG	ST-1	104,400	01-NOV-1996	CA	551,883,000
G	McLennan	Baylor University Cogeneration	NG	1	3,447	01-FEB-1988	GT	22,198,760

Data from US DOE 2000 Energy Information Administration's Forms EIA-860B and EIA-906

Cogeneration Facilities in Texas

Region	County	Facility Name	Primary Fuel	Unit Name	Nameplate Rating (kW)	Unit Startup Date	Prime Mover	Gross Generation in Year 2000 (kWhrs)
G	Milam	Sandow - Alcoa	NG	GEN1	121,000	01-DEC-1953	ST	999,034,000
G	Milam	Sandow - Alcoa	NG	GEN2	121,000	01-FEB-1954	ST	931,686,000
G	Milam	Sandow - Alcoa	NG	GEN3	121,000	01-JUL-1954	ST	1,040,242,000
H	Brazoria	Chocolate Bayou Plant - Solutia	NG	GEN2	1,200	01-OCT-1990	ST	13,848,300
H	Brazoria	Chocolate Bayou Plant - Solutia	NG	GEN3	2,000	01-OCT-1990	ST	7,536,200
H	Brazoria	Chocolate Bayou Plant - Solutia	NG	GEN4	46,100	01-OCT-2000	ST	47,148,000
H	Brazoria	Chocolate Bayou Works - BP	NG	GEN1	41,000	01-NOV-1985	GT	290,706,339
H	Brazoria	Dow Chemical	NG		170,000	2005		
H	Brazoria	Freeport - BASF	NG	GEN1	81,000	01-MAY-1999	CT	609,032,000
H	Brazoria	Freeport - BASF	NG	GEN2	11,700	01-JUN-1999	CA	51,231,000
H	Brazoria	Oyster Creek Unit VIII - Dow	NG	G84	200,970	01-OCT-1994	CA	1,091,010,000
H	Brazoria	Oyster Creek Unit VIII - Dow	NG	G81	99,025	01-OCT-1994	CT	635,255,000
H	Brazoria	Oyster Creek Unit VIII - Dow	NG	G82	99,025	01-OCT-1994	CT	590,877,000
H	Brazoria	Oyster Creek Unit VIII - Dow	NG	G83	99,025	01-OCT-1994	CT	634,762,000
H	Brazoria	Sweeny Cogeneration Facility - AEP	NG	GEN1	115,000	01-AUG-1997	GT	898,542,000
H	Brazoria	Sweeny Cogeneration Facility - AEP	NG	GEN2	115,000	01-SEP-1997	GT	939,189,000
H	Brazoria	Sweeny Cogeneration Facility - AEP	NG	GEN3	115,000	01-OCT-1997	GT	928,155,000
H	Brazoria	Sweeny Cogeneration Facility - AEP	NG	GEN4	115,000	01-DEC-2000	GT	10,804,000
H	Brazoria	The Dow Chemical Co Texas Operations	NG	G-67	119,000	01-MAR-1984	CT	593,061,000
H	Brazoria	The Dow Chemical Co Texas Operations	NG	G-34	71,400	01-DEC-1968	CT	0
H	Brazoria	The Dow Chemical Co Texas Operations	NG	G-35	119,000	01-FEB-1983	CT	593,061,000
H	Brazoria	The Dow Chemical Co Texas Operations	NG	G-36	119,000	01-FEB-1983	CT	593,061,000
H	Brazoria	The Dow Chemical Co Texas Operations	NG	G-37	75,000	01-APR-1978	CT	373,778,000
H	Brazoria	The Dow Chemical Co Texas Operations	NG	G-41	50,000	01-MAY-1958	CA	249,185,000
H	Brazoria	The Dow Chemical Co Texas Operations	NG	G-42	50,000	01-MAR-1959	CA	249,185,000
H	Brazoria	The Dow Chemical Co Texas Operations	NG	G-43	50,000	01-JUN-1961	CA	0
H	Brazoria	The Dow Chemical Co Texas Operations	NG	G-45	119,000	01-OCT-1983	CT	593,061,000
H	Brazoria	The Dow Chemical Co Texas Operations	NG	G-61	94,563	01-OCT-1982	CT	471,274,000
H	Brazoria	The Dow Chemical Co Texas Operations	NG	G-62	94,563	01-SEP-1982	CT	471,274,000
H	Brazoria	The Dow Chemical Co Texas Operations	NG	G-63	94,563	01-AUG-1982	CT	471,274,000
H	Brazoria	The Dow Chemical Co Texas Operations	NG	G-64	64,800	01-SEP-1987	CA	322,944,000
H	Brazoria	The Dow Chemical Co Texas Operations	NG	G-65	111,350	01-FEB-1984	CA	554,935,000
H	Brazoria	The Dow Chemical Co Texas Operations	NG	G-66	119,000	01-DEC-1983	CT	593,061,000
H	Brazoria	The Dow Chemical Co Texas Operations	NG	G-31	50,000	01-NOV-1952	CA	249,185,000
H	Brazoria	The Dow Chemical Co Texas Operations	NG	G-32	50,000	01-DEC-1952	CA	249,185,000
H	Brazoria	The Dow Chemical Co Texas Operations	NG	G-33	49,000	01-DEC-1953	CA	244,201,000
H	Chambers	Baytown Energy Center LP - Calpine / Bayer	NG		825,000	1-Apr-2002		
H	Chambers	Enterprise Products Operating LP	NG	GEN1	2,500	01-SEP-1984	GT	18,089,626
H	Chambers	Enterprise Products Operating LP	NG	GEN2	2,500	01-SEP-1984	GT	19,772,874
H	Chambers	Enterprise Products Operating LP	NG	GEN3	3,400	01-NOV-1991	GT	25,602,265
H	Chambers	Enterprise Products Operating LP	NG	GEN4	3,400	01-NOV-1991	GT	25,476,649
H	Chambers	Enterprise Products Operating LP	NG	GEN5	3,400	01-NOV-1991	GT	25,152,385
H	Chambers	Enterprise Products Operating LP	NG	GEN6	3,500	01-DEC-1996	GT	26,802,460
H	Chambers	Enterprise Products Operating LP	NG	GEN7	3,500	01-DEC-1996	GT	26,054,883
H	Chambers	Enterprise Products Operating LP	NG	GEN8	3,500	01-DEC-1996	GT	26,768,757
H	Fort Bend	Fort Bend Utilities Co	NG	GEN1	2,000	01-JUN-1937	ST	9,320,000

Data from US DOE 2000 Energy Information Administration's Forms EIA-860B and EIA-906

Cogeneration Facilities in Texas

Region	County	Facility Name	Primary Fuel	Unit Name	Nameplate Rating (kW)	Unit Startup Date	Prime Mover	Gross Generation in Year 2000 (kWhrs)
H	Fort Bend	Fort Bend Utilities Co	NG	GEN2	1,000	01-JUL-1941	ST	5,990,000
H	Fort Bend	Fort Bend Utilities Co	NG	GEN3	3,000	01-OCT-1983	ST	12,710,400
H	Fort Bend	Fort Bend Utilities Co	DFO	ENGN	500	01-MAR-1995	IC	28,117
H	Galveston	Green Power Unit 2 - Cinergy / BP	NG		641,000	1-Apr-2004		
H	Galveston	Power Station 3 - BP	NG	307A	22,059	01-JAN-1964	CA	31,232,135
H	Galveston	Power Station 3 - BP	NG	307B	22,059	01-JAN-1964	CA	39,040,166
H	Galveston	Power Station 3 - BP	NG	307C	15,600	01-JAN-1964	CT	93,696,400
H	Galveston	Power Station 3 - BP	NG	307D	22,059	01-JAN-1966	CA	101,504,433
H	Galveston	Power Station 3 - BP	NG	307E	15,600	01-JAN-1966	CT	109,312,466
H	Galveston	Power Station 3 - BP	NG	307F	20,750	01-JAN-1978	CT	2,016,000
H	Galveston	Power Station 4 - BP	PC	GEN1	78,210	01-SEP-1986	CT	590,332,000
H	Galveston	Power Station 4 - BP	PC	GEN2	78,210	01-SEP-1986	CT	590,332,000
H	Galveston	Power Station 4 - BP	PC	GEN3	34,703	01-SEP-1986	CA	295,166,000
H	Galveston	S&L Cogeneration	NG	GEN1	55,000	01-MAR-1992	GT	299,250,910
H	Galveston	Texas City Cogeneration LP - Calpine	NG	GEN1	141,000	01-MAY-1987	CA	922,000,474
H	Galveston	Texas City Cogeneration LP - Calpine	NG	GEN2	103,000	01-MAY-1987	CT	889,091,043
H	Galveston	Texas City Cogeneration LP - Calpine	NG	GEN3	103,000	01-MAY-1987	CT	898,138,375
H	Galveston	Texas City Cogeneration LP - Calpine	NG	GEN4	103,000	01-MAY-1987	CT	900,414,547
H	Galveston	Texas City Plant Union Carbide Corp	NG	GTG	40,000	02-FEB-1996	CT	272,344,000
H	Galveston	Texas City Plant Union Carbide Corp	NG	STG	56,000	01-MAR-1996	CA	241,081,000
H	Galveston	Valero Refining Co Texas City Refinery		GEN1	7,160	01-APR-1963	GT	34,119,852
H	Galveston	Valero Refining Co Texas City Refinery		GEN2	16,200	01-OCT-1991	GT	112,254,810
H	Galveston	Valero Refining Co Texas City Refinery		GEN3	16,200	01-SEP-1991	GT	105,516,492
H	Harris	AES Deepwater Inc	PC	GEN1	184,000	01-JUN-1986	ST	1,333,570,180
H	Harris	Bayou Cogeneration Plant - Air Liquide	NG	GEN1	75,000	01-DEC-1984	GT	650,472,000
H	Harris	Bayou Cogeneration Plant - Air Liquide	NG	GEN2	75,000	01-DEC-1984	GT	659,946,000
H	Harris	Bayou Cogeneration Plant - Air Liquide	NG	GEN3	75,000	01-MAR-1985	GT	661,509,000
H	Harris	Bayou Cogeneration Plant - Air Liquide	NG	GEN4	75,000	01-MAR-1985	GT	645,578,000
H	Harris	Baytown Turbine Generator Project - Exxon Mobile	NG	GEN2	37,333	01-APR-1989	GT	271,293,000
H	Harris	Baytown Turbine Generator Project - Exxon Mobile	NG	GEN4	100,000	01-JAN-1997	GT	655,598,000
H	Harris	Baytown Turbine Generator Project - Exxon Mobile	NG	GEN1	37,334	01-FEB-1989	GT	299,738,000
H	Harris	Baytown Turbine Generator Project - Exxon Mobile	NG	GEN3	37,333	01-MAR-1989	GT	296,836,000
H	Harris	Calpine - Channel	NG		180,000	delayed		
H	Harris	Channel Energy Center - Calpine / Lyondell CITGO	NG		560,000	1-Apr-2002	CT	
H	Harris	Clear Lake Cogeneration Ltd - Calpine	NG	G102	103,670	01-JAN-1985	CT	846,403,950
H	Harris	Clear Lake Cogeneration Ltd - Calpine	NG	G104	103,670	01-JAN-1985	CT	889,429,520
H	Harris	Clear Lake Cogeneration Ltd - Calpine	NG	S101	51,937	01-JAN-1985	CA	338,059,020
H	Harris	Clear Lake Cogeneration Ltd - Calpine	NG	S102	14,053	01-JAN-1985	CA	110,363,210
H	Harris	Clear Lake Cogeneration Ltd - Calpine	NG	G103	103,670	01-JAN-1985	CT	847,293,660
H	Harris	CoGen Lyondell Inc - Dynegey	NG	GEN6	115,000	01-APR-1986	CA	769,273,000
H	Harris	CoGen Lyondell Inc - Dynegey	NG	GEN7	79,000	01-JUN-1995	CT	589,833,000
H	Harris	CoGen Lyondell Inc - Dynegey	NG	GEN1	74,000	01-NOV-1985	CT	601,405,000
H	Harris	CoGen Lyondell Inc - Dynegey	NG	GEN2	74,000	01-DEC-1985	CT	606,164,000
H	Harris	CoGen Lyondell Inc - Dynegey	NG	GEN3	74,000	01-DEC-1985	CT	504,909,000
H	Harris	CoGen Lyondell Inc - Dynegey	NG	GEN4	74,000	01-MAR-1986	CT	510,013,000
H	Harris	CoGen Lyondell Inc - Dynegey	NG	GEN5	74,000	01-APR-1986	CT	489,633,000
H	Harris	Deer Park Energy Center - Calpine / Shell			773,000	1-Dec-2003		
H	Harris	Deer Park Plant - Occidental		GEN4	81,060	01-DEC-1985	CT	626,291,473

Data from US DOE 2000 Energy Information Administration's Forms EIA-860B and EIA-906

Cogeneration Facilities in Texas

Region	County	Facility Name	Primary Fuel	Unit Name	Nameplate Rating (kW)	Unit Startup Date	Prime Mover	Gross Generation in Year 2000 (kWhrs)
H	Harris	Deer Park Plant - Occidental		GEN1	10,000	01-APR-1948	CA	68,120,000
H	Harris	Deer Park Plant - Occidental		GEN2	10,000	01-APR-1948	CA	75,270,000
H	Harris	Deer Park Plant - Occidental		GEN3	10,000	01-APR-1948	CA	20,120,000
H	Harris	Dynegy / Lyondell			155,000	delayed		
H	Harris	Exxon Mobil Co USA Baytown PP3 PP4	NG	GT38	36,500	01-AUG-1989	GT	248,951,000
H	Harris	Exxon Mobil Co USA Baytown PP3 PP4	NG	GT44	20,000	01-JAN-1977	GT	165,574,000
H	Harris	Exxon Mobil Co USA Baytown PP3 PP4	NG	GT35	14,500	01-JAN-1970	GT	125,837,000
H	Harris	Exxon Mobil Co USA Baytown PP3 PP4	NG	GT36	15,250	01-JAN-1972	GT	79,165,000
H	Harris	Exxon Mobil Co USA Baytown PP3 PP4	NG	GT37	17,250	01-JAN-1976	GT	128,901,000
H	Harris	Exxon Mobil Co USA Baytown PP3 PP4	NG	GT41	20,000	01-JAN-1977	GT	186,456,000
H	Harris	Exxon Mobil Co USA Baytown PP3 PP4	NG	GT42	20,000	01-JAN-1977	GT	190,864,000
H	Harris	Exxon Mobil Co USA Baytown PP3 PP4	NG	GT43	20,000	01-JAN-1977	GT	180,426,000
H	Harris	Exxon Mobil Co USA Baytown PP3 PP4	NG	GT45	36,500	01-JUN-1988	GT	281,543,000
H	Harris	Exxon Mobil Co USA Baytown PP3 PP4	NG	ST33	7,500	01-JAN-1950	ST	49,537,000
H	Harris	Exxon Mobil Co USA Baytown PP3 PP4	NG	ST34	7,500	01-JAN-1952	ST	41,398,000
H	Harris	Houston Chemical Complex Battleground Site - Occidental / Diamond Shamrock	NG	GT1	74,000	01-MAY-1982	CT	560,154,139
H	Harris	Houston Chemical Complex Battleground Site - Occidental / Diamond Shamrock	NG	GT2	74,000	01-JUN-1982	CT	540,281,225
H	Harris	Houston Chemical Complex Battleground Site - Occidental / Diamond Shamrock	NG	ST	52,000	01-AUG-1982	CA	449,563,636
H	Harris	Pasadena - Air Products	NG	GEN1	4,000	01-JUL-1985	GT	21,716,105
H	Harris	Pasadena Cogeneration LP - Calpine	NG	CTG1	173,400	01-JUN-1998	CT	1,243,605,820
H	Harris	Pasadena Cogeneration LP - Calpine	NG	CTG2	175,000	01-JUN-2000	CT	71,669,660
H	Harris	Pasadena Cogeneration LP - Calpine	NG	CTG3	175,000	01-JUN-2000	CT	89,048,330
H	Harris	Pasadena Cogeneration LP - Calpine	NG	STG1	87,500	01-JUN-1998	CA	461,395,370
H	Harris	Pasadena Cogeneration LP - Calpine	NG	STG2	150,000	01-JUN-2000	CA	73,535,610
H	Harris	Pasadena Paper Company	NG	ATB1	10,000	01-JAN-1948	ST	0
H	Harris	Pasadena Paper Company	NG	ATB2	4,000	01-OCT-1943	ST	0
H	Harris	Reliant Energy Channelview LP - Equistar	NG		918,000	1-Jul-2002		
H	Harris	Rhodia Inc Houston Plant	OTH	GEN2	1,500	01-JAN-1970	ST	9,588,000
H	Harris	Rhodia Inc Houston Plant	OTH	GEN1	5,000	01-JAN-1970	ST	44,365,000
H	Harris	Rice University		GEN1	3,169	01-JAN-1986	GT	443,710
H	Harris	Rice University		GEN2	3,937	01-FEB-1989	GT	33,207,500
H	Harris	Sheldon Texas - Abitibi		TG1	33,000	01-JAN-1967	ST	133,580,000
H	Harris	Sheldon Texas - Abitibi		TG2	18,000	01-JAN-1967	GT	0
H	Harris	Sheldon Texas - Abitibi		TG3	18,000	01-JAN-1967	GT	80,710,000
H	Harris	Sheldon Texas - Abitibi		TG4	46,250	01-JAN-1974	ST	38,370,000
H	Harris	Shell Deer Park		GEN2	50,000	01-OCT-1979	ST	354,613,264
H	Harris	Shell Deer Park		GEN3	5,000	01-JUN-1943	ST	0
H	Harris	Shell Deer Park		GEN4	75,000	01-APR-1995	GT	638,836,442
H	Harris	Shell Deer Park		GEN5	75,000	01-APR-1995	GT	596,130,052
H	Harris	Shell Deer Park		GEN1	50,000	01-OCT-1979	ST	308,005,257
H	Harris	Solvay Polymers	NG		18,600	1-Aug-2001	GT	
H	Harris	Texas Petrochemicals Corp		TG2	35,000	01-JUN-1972	ST	307,085,952
H	Harris	Texas Petrochemicals Corp			900,000	2006		
H	Harris	Valero Refining Co Texas Houston Refinery	NG	GEN1	17,148	01-DEC-1990	GT	111,830,000
H	Harris	Valero Refining Co Texas Houston Refinery	NG	GEN2	17,148	01-DEC-1990	GT	108,770,000
H	Harris	Westhollow Technology Center - Shell	NG	1	3,725	01-JAN-1988	GT	34,464,000
H	Montgomery	Jameson Gas Processing Plant	BL	620	350	01-JAN-1981	IC	3,130,000
H	Montgomery	Jameson Gas Processing Plant	BL	621	350	01-JAN-1981	IC	3,260,000

Data from US DOE 2000 Energy Information Administration's Forms EIA-860B and EIA-906

Cogeneration Facilities in Texas

Region	County	Facility Name	Primary Fuel	Unit Name	Nameplate Rating (kW)	Unit Startup Date	Prime Mover	Gross Generation in Year 2000 (kWhrs)
H	Montgomery	Jameson Gas Processing Plant	BL	622	550	01-JAN-1986	IC	4,060,000
H	Montgomery	Jameson Gas Processing Plant	BL	623	550	01-JAN-1986	IC	0
I	Angelina	Lufkin Texas - Abitibi	NG	GEN2	7,500	01-JAN-1939	ST	39,083,415
I	Angelina	Lufkin Texas - Abitibi	NG	GEN3	12,500	01-JAN-1949	ST	76,851,481
I	Angelina	Lufkin Texas - Abitibi	NG	GEN4	12,500	01-JAN-1949	ST	74,905,385
I	Angelina	Lufkin Texas - Abitibi	NG	GEN5	15,625	01-MAR-1956	ST	59,732,380
I	Angelina	Lufkin Texas - Abitibi	NG	GEN6	15,625	01-APR-1956	ST	60,626,798
I	Angelina	Lufkin Texas - Abitibi	NG	GEN7	21,176	01-JAN-1968	ST	116,463,547
I	Jasper	Westvaco Evadale	NG	GEN1	7,500	01-JUN-1954	ST	68,160,000
I	Jasper	Westvaco Evadale	NG	GEN2	32,640	01-MAY-1965	ST	256,320,000
I	Jasper	Westvaco Evadale	NG	GEN3	17,600	01-JAN-1986	ST	151,200,000
I	Jefferson	Beaumont Refinery		GEN4	10,000	01-FEB-1957	ST	9,400,541
I	Jefferson	Beaumont Refinery		GEN5	10,000	01-JUN-1959	ST	43,937,571
I	Jefferson	Beaumont Refinery		GEN6	25,000	01-FEB-1978	ST	176,101,252
I	Jefferson	Beaumont Refinery		GEN7	25,000	01-JAN-1970	ST	170,507,443
I	Jefferson	Beaumont Refinery		GEN8	20,000	01-JAN-1966	ST	165,180,312
I	Jefferson	Beaumont Refinery		GEN9	30,000	01-JAN-1967	ST	162,713,675
I	Jefferson	Beaumont Refinery		GE10	7,500	01-JAN-1978	ST	35,473,445
I	Jefferson	Beaumont Refinery		GE11	38,670	01-JUN-1993	ST	67,723,746
I	Jefferson	Beaumont Refinery		GE12	38,670	01-JUN-1993	GT	221,574,975
I	Jefferson	JCO Oxides Olefins Plant - Huntsman	NG	CGG1	38,600	01-SEP-1992	GT	284,260,000
I	Jefferson	JCO Oxides Olefins Plant - Huntsman	NG	CGG2	38,600	01-SEP-1992	GT	287,721,000
I	Jefferson	NROC Cogeneration Facility - BASF	NG		75,000	1-Aug-2001		
I	Jefferson	Port Arthur	NG	GEN1	37,600	01-NOV-2000	CT	41,006,000
I	Jefferson	Port Arthur	NG	GEN2	3,000	01-NOV-2000	CA	120,000
I	Jefferson	Port Arthur Refinery - Motiva	NG	GEN5	10,000	01-JUN-1928	CA	24,981,000
I	Jefferson	Port Arthur Refinery - Motiva	NG	GEN1	17,250	01-JUN-1975	CT	124,112,000
I	Jefferson	Port Arthur Refinery - Motiva	NG	GEN2	13,750	01-JUN-1966	CT	107,710,000
I	Jefferson	Port Arthur Refinery - Motiva	NG	GEN3	13,750	01-JUN-1972	CT	89,798,000
I	Jefferson	Port Arthur Refinery - Motiva	NG	GEN4	10,000	01-JUN-1943	CA	0
I	Jefferson	Port Arthur Refinery - Motiva	NG	GEN6	10,000	01-JUN-1954	CA	55,126,000
I	Jefferson	Port Arthur Refinery - Motiva	NG	GEN7	10,000	01-JUN-1951	CA	53,415,000
I	Jefferson	Port Arthur Refinery - Motiva	NG	GN26	18,150	01-JUN-1970	CT	81,093,292
I	Jefferson	Port Arthur Refinery - Motiva	NG	GN31	10,000	01-JUN-1962	ST	57,858,969
I	Jefferson	Port Arthur Refinery - Motiva	NG	GN32	15,000	01-JUN-1957	ST	113,409,267
I	Jefferson	Port Arthur Refinery - Motiva	NG	GN33	18,000	01-JUN-1978	CA	75,301,086
I	Jefferson	Port Arthur Refinery - Motiva	NG	GN34	18,150	01-JUN-1970	CT	153,427,191
I	Jefferson	Port Arthur Refinery - Motiva	NG	GN35	33,750	01-DEC-1983	CT	202,880,146
I	Jefferson	Port Arthur Refinery - Motiva	NG	GN27	12,300	01-MAY-1984	CA	39,712,543
I	Jefferson	Port Arthur Texas Refinery - FINA	NG	GEN1	38,400	01-AUG-1988	GT	270,398,400
I	Jefferson	Pt Neches Plant - Air Liquide	OG	G1	38,000	01-FEB-1994	GT	277,557,152
I	Jefferson	The Goodyear&Tire Rubber Co	BL	2N80	5,000	01-AUG-1999	CT	37,877,033
I	Jefferson	The Goodyear&Tire Rubber Co	BL	3N80	14,877	01-MAR-1987	CA	101,005,422
I	Jefferson	The Goodyear&Tire Rubber Co	BL	N802	5,000	01-AUG-1997	CT	37,877,033
I	Jefferson	The Goodyear&Tire Rubber Co	BL	N803	5,000	01-OCT-1999	CT	37,877,033
I	Jefferson	The Goodyear&Tire Rubber Co	BL	N804	5,000	01-OCT-1999	CT	37,877,033

Data from US DOE 2000 Energy Information Administration's Forms EIA-860B and EIA-906

Cogeneration Facilities in Texas

Region	County	Facility Name	Primary Fuel	Unit Name	Nameplate Rating (kW)	Unit Startup Date	Prime Mover	Gross Generation in Year 2000 (kWhrs)
I	Orange	Engineered Carbons Echo Cogeneration	NG	GEN1	10,000	01-MAY-1985	ST	22,018,000
I	Orange	Inland Paperboard and Packaging	NG	TG	48,000	01-NOV-1967	ST	287,935,000
I	Orange	Sabine Cogen LP - Air Liquide		CTG1	37,210	01-JAN-2000	CT	297,068,557
I	Orange	Sabine Cogen LP - Air Liquide		CTG2	37,210	01-JAN-2000	CT	295,682,654
I	Orange	Sabine Cogen LP - Air Liquide		STG	27,044	01-JAN-2000	CA	101,887,384
I	Orange	Sabine River Works - du Pont	NG	GEN4	6,250	01-JAN-1948	CA	26,041,125
I	Orange	Sabine River Works - du Pont	NG	GEN1	89,900	01-MAR-1987	CT	679,700,000
I	Orange	Sabine River Works - du Pont	NG	GEN2	3,125	01-JAN-1948	CA	17,001,350
I	Orange	Sabine River Works - du Pont	NG	GEN3	6,250	01-JAN-1948	CA	36,006,250
I	Orange	SRW Cogeneration Limited Partnership - Conoco / duPont	NG		525,000	1-Nov-2001		
I	Panola	East Texas Gas Plant	NG	G-1	300	01-JAN-1948	IC	1,278,000
I	Panola	East Texas Gas Plant	NG	G-2	300	01-JAN-1948	IC	1,460,000
I	Panola	East Texas Gas Plant	NG	G-3	300	01-JAN-1948	IC	1,333,000
I	Panola	East Texas Gas Plant	NG	G-4	400	01-JAN-1965	IC	2,598,600
I	Panola	East Texas Gas Plant	NG	G-6	300	01-JAN-1979	IC	1,268,200
I	Panola	East Texas Gas Plant	NG	G-7	300	01-DEC-1979	IC	1,397,400
I	Panola	East Texas Gas Plant	NG	G-8	300	01-DEC-1979	IC	1,692,800
J								
K	Hays	Southwest Texas State University Cogen	NG	GEN1	6,000	01-SEP-1989	IC	34,929,600
K	Travis	Austin State Hospital	NG	GEN1	1,000	01-APR-1994	GT	7,021,728
K	Travis	Central Utility Plant - 3M	NG	EG1	6,080	01-JUL-1988	IC	12,768,000
K	Travis	Central Utility Plant - 3M	NG	EG2	6,080	01-JUL-1988	IC	18,600,000
K	Travis	Central Utility Plant - 3M	NG	TG1	2,300	01-JUL-1988	ST	1,400,000
K	Travis	Sunset Farms - BFI	NG	1	1,010	01-DEC-1996	IC	5,983,308
K	Travis	Sunset Farms - BFI	NG	2	1,010	01-DEC-1996	IC	6,093,900
K	Travis	Sunset Farms - BFI	NG	3	1,010	01-DEC-1996	IC	6,004,260
K	Travis	University of Texas at Austin	NG	GEN1	1,500	01-OCT-1933	ST	0
K	Travis	University of Texas at Austin	NG	GEN2	1,500	01-OCT-1933	ST	0
K	Travis	University of Texas at Austin	NG	GEN3	2,500	01-JAN-1938	ST	0
K	Travis	University of Texas at Austin	NG	GEN4	7,617	01-OCT-1951	CA	7,668,180
K	Travis	University of Texas at Austin	NG	GEN5	6,000	01-SEP-1959	CA	8,689,460
K	Travis	University of Texas at Austin	NG	GEN6	12,500	01-JAN-1968	CT	26,105,320
K	Travis	University of Texas at Austin	NG	GEN7	28,800	01-JAN-1979	CA	98,753,280
K	Travis	University of Texas at Austin	NG	GEN8	48,510	01-NOV-1987	CT	184,307,920
L	Bexar	University of Texas at San Antonio	NG	GEN1	3,470	01-JAN-1980	IC	4,462,080
L	Calhoun	BP Chemicals Green Lake Plant	OG	TG3	23,800	01-JAN-1997	ST	134,724,370
L	Calhoun	BP Chemicals Green Lake Plant	OG	TG2	15,000	01-MAR-1989	ST	93,392,730
L	Calhoun	Formosa Utility Venture Ltd	NG	BO3	37,400	01-MAR-1987	CT	168,826,000
L	Calhoun	Formosa Utility Venture Ltd	NG	ST1	33,500	01-MAR-1994	CA	229,507,000
L	Calhoun	Formosa Utility Venture Ltd	NG	ST2	66,300	01-MAR-1994	CA	416,902,000
L	Calhoun	Formosa Utility Venture Ltd	NG	TBG1	103,000	01-APR-1993	CT	555,124,000
L	Calhoun	Formosa Utility Venture Ltd	NG	TBG2	103,000	01-JUL-1993	CT	669,123,000
L	Calhoun	Formosa Utility Venture Ltd	NG	TBG3	103,000	01-SEP-1993	CT	660,853,000

Data from US DOE 2000 Energy Information Administration's Forms EIA-860B and EIA-906

Cogeneration Facilities in Texas

Region	County	Facility Name	Primary Fuel	Unit Name	Nameplate Rating (kW)	Unit Startup Date	Prime Mover	Gross Generation in Year 2000 (kWhrs)
L	Calhoun	Formosa Utility Venture Ltd	NG	TBG4	103,000	01-MAY-1994	CT	627,764,000
L	Calhoun	Formosa Utility Venture Ltd	NG	TBG5	103,000	01-OCT-1994	CT	597,917,000
L	Calhoun	Pt Comfort Operations - Alcoa	NG	GEN1	16,000	01-JAN-1958	ST	97,274,276
L	Calhoun	Pt Comfort Operations - Alcoa	NG	GEN2	16,000	01-JAN-1958	ST	98,084,301
L	Calhoun	Pt Comfort Operations - Alcoa	NG	GEN3	16,000	01-JAN-1958	ST	97,980,343
L	Calhoun	Pt Comfort Operations - Alcoa	NG	GEN4	15,100	01-JAN-1970	ST	94,578,080
L	Calhoun	Seadrift Coke LP	AB	GEN1	7,600	01-NOV-1983	ST	42,130,000
L	Calhoun	Seadrift Plant Union Carbide Corp	NG	GEN5	15,000	01-NOV-1987	CA	63,251,710
L	Calhoun	Seadrift Plant Union Carbide Corp	NG	GEN6	35,000	01-NOV-1987	CT	277,847,764
L	Calhoun	Seadrift Plant Union Carbide Corp	NG	GEN7	6,000	01-NOV-1987	CA	45,477,053
L	Calhoun	Seadrift Plant Union Carbide Corp	NG	GEN8	35,000	01-NOV-1987	CT	295,280,886
L	Calhoun	Seadrift Plant Union Carbide Corp	NG	GEN9	15,000	01-NOV-1987	CA	66,805,743
L	Calhoun	Seadrift Plant Union Carbide Corp	NG	IGT	12,000	01-JAN-1969	CT	48,711,949
L	Calhoun	Seadrift Plant Union Carbide Corp	NG	GEN3	15,000	01-JAN-1964	CA	45,392,932
L	Calhoun	Seadrift Plant Union Carbide Corp	NG	GE11	35,000	01-NOV-2000	CT	31,371,153
L	Victoria	Victoria Texas Plant - duPont		GEN1	80,000	01-APR-1987	GT	705,590,133
M	Cameron	Rio Grande Valley Sugar Growers Inc	AB	GENA	2,500	01-OCT-1973	ST	7,952,000
M	Cameron	Rio Grande Valley Sugar Growers Inc	AB	GENC	2,500	01-JAN-1995	ST	1,040,000
M	Cameron	Rio Grande Valley Sugar Growers Inc	AB	GENB	2,500	01-OCT-1973	ST	6,589,000
N	Live Oak	US Gen - Diamond Shamrock			700,000	????		
N	Nueces	Celanese Engineering Resin Inc	NG	GEN1	1,492	01-JAN-1982	OT	0
N	Nueces	Celanese Engineering Resin Inc	NG	GEN2	1,492	01-JAN-1982	OT	0
N	Nueces	Celanese Engineering Resin Inc	NG	GEN3	1,678	01-JAN-1982	OT	0
N	Nueces	Celanese Engineering Resin Inc	NG	GEN4	8,200	01-JAN-1982	CA	22,082,000
N	Nueces	Celanese Engineering Resin Inc	NG	GEN5	35,540	01-APR-1989	CT	269,232,000
N	Nueces	Corpus Christi Energy Center - Calpine / CITGO	OG		570,000	1-Aug-2002		
N	Nueces	Corpus Christi Plant - Equistar	NG	GEN1	45,176	01-MAY-1989	GT	292,238,000
N	Nueces	Corpus Christi Refinery - Koch East	NG	GEN1	20,000	01-SEP-1984	GT	164,824,784
N	Nueces	Corpus Christi Refinery - Koch East	NG	GEN2	20,000	01-OCT-1984	GT	142,576,817
N	Nueces	Koch Petroleum Group LP Corpus Refinery	NG	FCCE	9,700	01-MAY-1985	OT	0
N	Nueces	Koch Petroleum Group LP Corpus Refinery	NG	FR6	55,000	01-MAY-1988	GT	274,723,000
N	Nueces	Valero Refinery		PRU	12,000	01-SEP-1983	OT	0
N	Nueces	Valero Refinery		TG1	28,600	01-NOV-1983	ST	118,340,000
N	Nueces	Valero Refinery		TG2	28,600	01-NOV-1983	ST	104,300,000
N	Nueces	Valero Refinery		TG3	7,500	01-SEP-1986	ST	58,786,000
N	San Patricio	Gregory Power Facility	NG	101G	182,000	01-JUL-2000	CT	672,733,700
N	San Patricio	Gregory Power Facility	NG	102G	182,000	01-JUL-2000	CT	679,550,800
N	San Patricio	Gregory Power Facility	NG	ST -	100,000	01-JUL-2000	CA	283,377,200
N	San Patricio	Ingleside Cogeneration	NG	STG	208,000	01-JUL-1999	CA	918,649,600
N	San Patricio	Ingleside Cogeneration	NG	CTG1	160,000	01-JUL-1999	CT	1,042,066,600
N	San Patricio	Ingleside Cogeneration	NG	CTG2	160,000	01-JUL-1999	CT	998,668,600
N	San Patricio	Reynolds Metals Co Sherwin Plant		1	6,000	01-JAN-1953	CA	48,886,967
N	San Patricio	Reynolds Metals Co Sherwin Plant		2	6,000	01-JAN-1953	CA	48,354,139
N	San Patricio	Reynolds Metals Co Sherwin Plant		3	6,000	01-JAN-1957	CA	50,108,997

Data from US DOE 2000 Energy Information Administration's Forms EIA-860B and EIA-906

Cogeneration Facilities in Texas

Region	County	Facility Name	Primary Fuel	Unit Name	Nameplate Rating (kW)	Unit Startup Date	Prime Mover	Gross Generation in Year 2000 (kWhrs)
N	San Patricio	Reynolds Metals Co Sherwin Plant		4	6,000	01-JAN-1958	CA	50,456,493
N	San Patricio	Reynolds Metals Co Sherwin Plant		5	7,500	01-JAN-1966	CT	33,753,494
N	San Patricio	Reynolds Metals Co Sherwin Plant		6	7,500	01-JAN-1966	CT	29,739,910
O	Gaines	North Riley	NG	GEN1	1,000	01-JAN-1990	IC	0
O	Gaines	North Riley	NG	GEN2	1,000	01-JAN-1990	IC	8,054,635
O	Gaines	North Riley	NG	GEN3	1,000	01-JAN-1990	IC	7,878,165
O	Yoakum	Wasson CO2 Removal Plant - Occidental		GEN1	23,400	01-FEB-1988	GT	152,921,600
P								
		Texas Cogen 2000 Generation (kWhrs)						71,308,408,901

Acronyms for Appendix A

Prime Mover

ST	Steam Turbine
GT	Gas Turbines
CT	Combined Cycle Gas Turbine
CA	Combined Cycle Steam Turbine
WT	Wind Turbine
IC	Internal Combustion Engine
OT	Other Turbine
CC	Combined Cycle Plant
HY	Hydroelectric Turbine
CS	Combined Cycle Unit on Common Shaft
PV	Photovoltaic

Fuel Supply

NG	Natural Gas
SUB	Subbituminous Coal
WIND	Wind
WAT	Water
OTH	Other
DFO	Diesel Fuel Oil
LFG	Land Field Gas
LIG	Lignite
SUN	Sun
NUC	Nuclear
WH	Waste Heat
BIT	Bituminous Coal
OG	Other Gas
PC	Coke
BL	Natural gas liquids
AB	Bagasse

For those facilities that have no information in the Table, the information was not available or was not completed by the respondent to the FERC survey.

Appendix B
Projected Electrical Demand and Population
Growth in Texas

Projected Annual Statewide Steam Electric Generation and Water Demand

Year	Electric Demand (GWh)	Percent of Year 2000 Baseline Electric Demand	Increase Factor over Year 2000 Based on Medium Use Scenario	Calculated Annual Statewide Steam Electric Water Use (Acre feet)	2002 State Water Plan Steam Electric Water Use
2000	337,582			621,601	607,527
2001	340,142	1.0076	1.0052	624,862	
2002	350,129	1.0372	1.0257	637,581	
2003	357,471	1.0589	1.0408	646,932	
2004	366,511	1.0857	1.0593	658,445	
2005	373,979	1.1078	1.0746	667,956	
2006	383,482	1.1360	1.0940	680,059	
2007	391,612	1.1601	1.1107	690,414	
2008	401,228	1.1885	1.1304	702,660	
2009	410,415	1.2157	1.1492	714,361	
2010	418,623	1.2401	1.1660	724,814	831,301
2011	426,996	1.2649	1.1832	735,478	
2012	435,536	1.2902	1.2007	746,355	
2013	444,246	1.3160	1.2185	757,448	
2014	453,131	1.3423	1.2367	768,764	
2015	462,194	1.3691	1.2553	780,306	
2016	471,438	1.3965	1.2743	792,079	
2017	480,867	1.4244	1.2936	804,088	
2018	490,484	1.4529	1.3133	816,336	
2019	500,294	1.4820	1.3334	828,830	
2020	510,299	1.5116	1.3539	841,572	917,994
2021	520,505	1.5419	1.3748	854,570	
2022	530,916	1.5727	1.3961	867,830	
2023	541,534	1.6042	1.4179	881,353	
2024	552,365	1.6362	1.4401	895,147	
2025	563,412	1.6690	1.4627	909,216	
2026	574,680	1.7023	1.4858	923,567	
2027	586,174	1.7364	1.5093	938,206	
2028	597,897	1.7711	1.5334	953,136	
2029	609,855	1.8065	1.5579	968,366	
2030	622,052	1.8427	1.5828	983,900	1,007,424
2031	634,493	1.8795	1.6083	999,744	
2032	647,183	1.9171	1.6343	1,015,906	
2033	660,127	1.9555	1.6609	1,032,392	
2034	673,329	1.9946	1.6879	1,049,205	
2035	686,796	2.0345	1.7155	1,066,357	
2036	700,532	2.0751	1.7436	1,083,851	
2037	714,542	2.1166	1.7723	1,101,694	
2038	728,833	2.1590	1.8016	1,119,895	
2039	743,410	2.2022	1.8315	1,138,460	
2040	758,278	2.2462	1.8620	1,157,396	1,057,929
2041	773,444	2.2911	1.8930	1,176,711	
2042	788,913	2.3370	1.9247	1,196,412	
2043	804,691	2.3837	1.9571	1,216,507	
2044	820,785	2.4314	1.9900	1,237,004	

2000 through 2009 Generation Projections from PUCT's 2000 Annual Update of Generating Electric Utility Data

Projected Annual Statewide Steam Electric Generation and Water Demand

Year	Electric Demand (GWh)	Percent of Year 2000 Baseline Electric Demand	Increase Factor over Year 2000 Based on Medium Use Scenario	Calculated Annual Statewide Steam Electric Water Use (Acre feet)	2002 State Water Plan Steam Electric Water Use
2045	837,200	2.4800	2.0237	1,257,910	
2046	853,944	2.5296	2.0580	1,279,235	
2047	871,023	2.5802	2.0930	1,300,987	
2048	888,444	2.6318	2.1287	1,323,174	
2049	906,213	2.6844	2.1651	1,345,804	
2050	924,337	2.7381	2.2022	1,368,887	1,134,644
2051	942,824	2.7929	2.2401	1,392,432	
2052	961,680	2.8487	2.2787	1,416,446	
2053	980,914	2.9057	2.3181	1,440,943	
2054	1,000,532	2.9638	2.3583	1,465,928	
2055	1,020,543	3.0231	2.3993	1,491,414	
2056	1,040,953	3.0836	2.4411	1,517,408	
2057	1,061,772	3.1452	2.4838	1,543,923	
2058	1,083,008	3.2081	2.5273	1,570,968	
2059	1,104,668	3.2723	2.5717	1,598,554	
2060	1,126,761	3.3377	2.6169	1,626,692	

2000 through 2009 Generation Projections from PUCT's 2000 Annual Update of Generating Electric Utility Data

Projected Annual Electric Generation in Texas

Year	Statewide Generation at 2 Percent Annual Growth (GWh)	Statewide Population from TWDB	Per Capita Generation at 0.5% Annual Growth (kWh / person)	Generation Based on Per Capita Increases (GWh)
2000	337,582	20,851,820	16,805	350,408
2001	340,142		16,889	
2002	350,129		16,973	
2003	357,471		17,058	
2004	366,511		17,143	
2005	373,979		17,229	
2006	383,482		17,315	
2007	391,612		17,402	
2008	401,228		17,489	
2009	410,415		17,576	
2010	418,623	24,843,049	17,664	438,829
2011	426,996		17,752	
2012	435,536		17,841	
2013	444,246		17,930	
2014	453,131		18,020	
2015	462,194		18,110	
2016	471,438		18,201	
2017	480,867		18,292	
2018	490,484		18,383	
2019	500,294		18,475	
2020	510,299	28,976,537	18,567	538,019
2021	520,505		18,660	
2022	530,916		18,754	
2023	541,534		18,847	
2024	552,365		18,942	
2025	563,412		19,036	
2026	574,680		19,131	
2027	586,174		19,227	
2028	597,897		19,323	
2029	609,855		19,420	
2030	622,052	32,859,050	19,517	641,308
2031	634,493		19,615	
2032	647,183		19,713	
2033	660,127		19,811	
2034	673,329		19,910	
2035	686,796		20,010	
2036	700,532		20,110	
2037	714,542		20,210	
2038	728,833		20,311	
2039	743,410		20,413	
2040	758,278	36,599,116	20,515	750,832
2041	773,444		20,618	
2042	788,913		20,721	
2043	804,691		20,824	
2044	820,785		20,928	

2000 through 2009 Generation Projections from PUCT's 2000 Annual Update of Generating Electric Utility Data

Projected Annual Electric Generation in Texas

Year	Statewide Generation at 2 Percent Annual Growth (GWh)	Statewide Population from TWDB	Per Capita Generation at 0.5% Annual Growth (kWh / person)	Generation Based on Per Capita Increases (GWh)
2045	837,200		21,033	
2046	853,944		21,138	
2047	871,023		21,244	
2048	888,444		21,350	
2049	906,213		21,457	
2050	924,337	40,676,622	21,564	877,157
2051	942,824		21,672	
2052	961,680		21,780	
2053	980,914		21,889	
2054	1,000,532		21,999	
2055	1,020,543		22,109	
2056	1,040,953		22,219	
2057	1,061,772		22,330	
2058	1,083,008		22,442	
2059	1,104,668		22,554	
2060	1,126,761	45,073,480	22,667	1,021,679

TWDB Population Projections

SUMMARY OF CONSENSUS PROJECTIONS BY REGION						
REGION	2010	2020	2030	2040	2050	2060
A	388,104	423,380	453,354	484,954	516,729	541,035
B	206,651	214,838	219,163	220,124	219,235	217,792
C	6,649,046	7,992,835	9,122,938	10,278,602	11,595,104	13,127,140
D	732,952	798,285	858,489	922,540	1,008,562	1,135,849
E	849,410	1,012,003	1,154,277	1,276,770	1,399,011	1,520,758
F	618,889	656,480	682,132	700,806	714,045	724,094
G	1,924,055	2,206,292	2,493,227	2,772,013	3,065,219	3,362,318
H	5,786,820	6,718,964	7,691,334	8,665,201	9,750,704	10,908,906
I	1,081,934	1,149,624	1,206,974	1,258,230	1,331,206	1,430,298
J	135,723	158,645	178,342	190,551	198,594	205,910
K	1,280,177	1,543,110	1,789,130	1,956,631	2,138,773	2,337,679
L*	2,468,426	2,885,282	3,284,171	3,634,543	3,974,576	4,287,988
M	1,581,207	1,973,188	2,401,223	2,854,613	3,337,618	3,826,001
N	617,143	693,940	758,427	810,650	853,964	885,665
O	486,311	512,405	528,437	535,967	537,255	527,210
P	34,191	35,246	35,402	34,881	33,977	32,777
Total (proposed)	24,843,049	28,976,537	32,859,050	36,599,116	40,676,622	45,073,480
2002 SWP	24,537,141	28,792,303	32,774,870	36,413,817	39,617,389	

Data provided by the TWDB, Regional Population Projection Summary-working 5_14Bexarrevision.

Appendix C
Steam Electric Water Supplies, Demands, and
Shortages per the 2002 State Water Plan

**2002 STATE WATER PLAN
STEAM ELECTRIC WATER DEMAND PROJECTIONS (acre feet)**

REGION	CNTY	NAME	d1990	d2000	d2010	d2020	d2030	d2040	d2050
State Total		TEXAS	425,945	607,527	831,301	917,994	1,007,424	1,057,929	1,134,644
A	6	ARMSTRONG	0	0	0	0	0	0	0
A	33	CARSON	0	0	0	0	0	0	0
A	38	CHILDRESS	0	0	0	0	0	0	0
A	44	COLLINGSWORTH	0	0	0	0	0	0	0
A	56	DALLAM	0	0	0	0	0	0	0
A	65	DONLEY	0	0	0	0	0	0	0
A	90	GRAY	0	0	0	0	0	0	0
A	96	HALL	0	0	0	0	0	0	0
A	98	HANSFORD	0	0	0	0	0	0	0
A	103	HARTLEY	0	0	0	0	0	0	0
A	106	HEMPHILL	0	0	0	0	0	0	0
A	117	HUTCHINSON	0	0	0	0	0	0	0
A	148	LIPSCOMB	0	0	0	0	0	0	0
A	171	MOORE	359	200	200	200	200	200	200
A	179	OCHILTREE	0	0	0	0	0	0	0
A	180	OLDHAM	0	0	0	0	0	0	0
A	188	POTTER	3,528	18,300	22,432	25,387	26,804	28,408	30,011
A	191	RANDALL	0	0	0	0	0	0	0
A	197	ROBERTS	0	0	0	0	0	0	0
A	211	SHERMAN	0	0	0	0	0	0	0
A	242	WHEELER	0	0	0	0	0	0	0
			3,887	18,500	22,632	25,587	27,004	28,608	30,211
B	5	ARCHER	0	0	14,000	14,000	14,000	14,000	14,000
B	12	BAYLOR	0	0	0	0	0	0	0
B	39	CLAY	0	0	0	0	0	0	0
B	51	COTTLE	0	0	0	0	0	0	0
B	78	FOARD	0	0	0	0	0	0	0
B	99	HARDEMAN	2,856	1,000	1,000	1,000	1,000	1,000	1,000
B	135	KING	0	0	0	0	0	0	0
B	169	MONTAGUE	0	0	0	0	0	0	0
B	243	WICHITA	0	360	360	360	360	360	360
B	244	WILBARGER	7,876	8,100	12,000	16,000	20,000	20,000	20,000
B	252	YOUNG (P)	0	0	0	0	0	0	0
			10,732	9,460	27,360	31,360	35,360	35,360	35,360
C	43	COLLIN	1,635	2,000	7,000	7,000	7,000	10,000	10,000
C	49	COOKE	0	0	0	0	0	0	0
C	57	DALLAS	18,214	18,000	20,000	25,000	25,000	25,000	25,000
C	61	DENTON	0	0	4,500	4,500	4,500	6,000	6,000
C	70	ELLIS	0	0	15,000	15,000	15,000	18,000	18,000
C	74	FANNIN	6,726	5,000	6,000	7,000	8,000	9,000	10,000
C	81	FREESTONE	13,834	16,000	27,000	29,000	29,000	33,192	33,192
C	91	GRAYSON	0	0	0	0	0	0	0
C	107	HENDERSON (P)	2,299	4,000	4,000	4,000	4,000	4,000	4,000
C	119	JACK	0	0	0	0	0	0	0
C	129	KAUFMAN	0	7,800	8,000	8,000	10,000	10,000	15,000
C	175	NAVARRO	0	0	0	0	0	0	0
C	184	PARKER	39	0	6,000	6,000	10,000	12,000	12,000
C	199	ROCKWALL	0	0	5,600	6,000	6,000	6,000	6,000
C	220	TARRANT	4,212	7,000	8,000	10,000	10,000	11,800	11,800
C	249	WISE	0	0	11,200	11,200	11,200	11,200	11,200
			46,959	59,800	122,300	132,700	139,700	156,192	162,192
D	19	BOWIE	0	0	0	0	0	0	0
D	32	CAMP	0	0	0	0	0	0	0
D	34	CASS	0	0	0	0	0	0	0

**2002 STATE WATER PLAN
STEAM ELECTRIC WATER DEMAND PROJECTIONS (acre feet)**

REGION	CNTY	NAME	d1990	d2000	d2010	d2020	d2030	d2040	d2050
State Total		TEXAS	425,945	607,527	831,301	917,994	1,007,424	1,057,929	1,134,644
D	60	DELTA	0	0	0	0	0	0	0
D	80	FRANKLIN	0	0	0	0	0	0	0
D	92	GREGG	465	1,251	1,251	1,251	1,251	1,251	1,251
D	102	HARRISON	4,869	5,760	5,760	5,760	5,760	5,760	5,760
D	112	HOPKINS	0	0	0	0	0	0	0
D	116	HUNT	834	516	516	516	516	516	516
D	139	LAMAR	0	12,209	12,209	12,209	12,209	12,209	12,209
D	158	MARION	1,953	2,868	2,868	2,868	2,868	2,868	2,868
D	172	MORRIS	8	48	48	48	48	48	48
D	190	RAINS	0	0	0	0	0	0	0
D	194	RED RIVER	1,494	1,500	5,000	7,000	10,000	10,000	10,000
D	212	SMITH (P)	0	0	0	0	0	0	0
D	225	TITUS	36,406	28,280	31,280	31,280	36,280	36,280	36,280
D	230	UPSHUR	0	0	5,601	5,601	5,601	5,601	5,601
D	234	VAN ZANDT	0	0	0	0	0	0	0
D	250	WOOD	0	0	7,500	7,500	7,500	7,500	15,000
			46,029	52,432	72,033	74,033	82,033	82,033	89,533
E	22	BREWSTER	0	0	0	0	0	0	0
E	55	CULBERSON	0	0	0	0	0	0	0
E	71	EL PASO	5,517	6,000	6,000	6,000	6,000	6,000	6,000
E	115	HUDSPETH	0	0	0	0	0	0	0
E	122	JEFF DAVIS	0	0	0	0	0	0	0
E	189	PRESIDIO	0	0	0	0	0	0	0
E	222	TERRELL	0	0	0	0	0	0	0
			5,517	6,000	6,000	6,000	6,000	6,000	6,000
F	2	ANDREWS	0	0	0	0	0	0	0
F	17	BORDEN	0	0	0	0	0	0	0
F	25	BROWN	0	0	0	0	0	0	0
F	41	COKE	445	835	835	835	835	835	835
F	42	COLEMAN	0	0	0	0	0	0	0
F	48	CONCHO	0	0	0	0	0	0	0
F	52	CRANE	0	0	0	0	0	0	0
F	53	CROCKETT	1,509	1,914	4,280	4,280	4,280	4,280	4,280
F	68	ECTOR	0	6,700	6,700	6,700	6,700	6,700	6,700
F	87	GLASSCOCK	0	0	0	0	0	0	0
F	114	HOWARD	0	1,380	1,380	1,380	1,380	1,380	1,380
F	118	IRION	0	0	0	0	0	0	0
F	134	KIMBLE	0	0	0	0	0	0	0
F	151	LOVING	0	0	0	0	0	0	0
F	154	MCCULLOCH	0	0	0	0	0	0	0
F	159	MARTIN	0	0	0	0	0	0	0
F	160	MASON	0	0	0	0	0	0	0
F	164	MENARD	0	0	0	0	0	0	0
F	165	MIDLAND	0	0	0	0	0	0	0
F	168	MITCHELL	3,682	4,000	4,400	5,280	6,336	7,603	9,124
F	186	PECOS	0	6	6	6	6	6	6
F	192	REAGAN	0	0	0	0	0	0	0
F	195	REEVES	0	0	0	0	0	0	0
F	200	RUNNELS	0	0	0	0	0	0	0
F	207	SCHLEICHER	0	0	0	0	0	0	0
F	208	SCURRY	0	0	0	0	0	0	0
F	216	STERLING	0	0	0	0	0	0	0
F	218	SUTTON	0	0	0	0	0	0	0
F	226	TOM GREEN	869	1,020	3,680	3,680	3,680	3,680	3,680
F	231	UPTON	0	0	0	0	0	0	0
F	238	WARD	5,570	5,500	6,050	7,260	8,712	10,454	12,545

**2002 STATE WATER PLAN
STEAM ELECTRIC WATER DEMAND PROJECTIONS (acre feet)**

REGION	CNTY	NAME	d1990	d2000	d2010	d2020	d2030	d2040	d2050
State Total		TEXAS	425,945	607,527	831,301	917,994	1,007,424	1,057,929	1,134,644
F	248	WINKLER	0	0	0	0	0	0	0
			12,075	21,355	27,331	29,421	31,929	34,938	38,550
G	14	BELL	0	0	11,200	11,200	11,200	11,200	11,200
G	18	BOSQUE	0	0	5,600	5,600	5,600	5,600	5,600
G	21	BRAZOS	3,953	5,000	5,000	5,000	5,000	5,000	5,000
G	26	BURLESON	0	0	0	0	0	0	0
G	30	CALLAHAN	0	0	0	0	0	0	0
G	47	COMANCHE	0	0	0	0	0	0	0
G	50	CORYELL	0	0	0	0	0	0	0
G	67	EASTLAND	0	0	0	0	0	0	0
G	72	ERATH	0	0	0	0	0	0	0
G	73	FALLS	0	0	0	0	0	0	0
G	76	FISHER	0	0	0	0	0	0	0
G	93	GRIMES	11,088	10,000	20,000	20,000	20,000	20,000	20,000
G	97	HAMILTON	0	0	0	0	0	0	0
G	104	HASKELL	546	700	2,340	3,000	3,000	3,000	3,000
G	109	HILL	0	0	0	0	0	0	0
G	111	HOOD	4,212	4,500	6,700	6,700	6,700	6,700	6,700
G	126	JOHNSON	0	0	0	0	0	0	0
G	127	JONES	2,041	2,340	3,556	10,324	10,324	10,324	10,324
G	132	KENT	0	0	0	0	0	0	0
G	138	KNOX	0	0	0	0	0	0	0
G	141	LAMPASAS	0	0	0	0	0	0	0
G	144	LEE	0	0	0	0	0	0	0
G	147	LIMESTONE	4,692	18,000	20,000	20,000	20,000	20,000	20,000
G	155	MCLENNAN	14,366	15,000	15,000	20,000	25,000	30,000	35,000
G	166	MILAM	2,716	8,680	8,680	12,500	12,500	12,500	16,000
G	177	NOLAN	0	0	0	0	0	0	0
G	182	PALO PINTO	1,898	2,500	3,000	3,000	3,000	3,000	3,000
G	198	ROBERTSON	0	15,000	28,000	30,000	30,000	35,000	40,000
G	209	SHACKELFORD	0	0	0	0	0	0	0
G	213	SOMERVELL	9,845	18,000	23,200	23,200	23,200	23,200	23,200
G	215	STEPHENS	0	0	0	0	0	0	0
G	217	STONEWALL	0	0	0	0	0	0	0
G	221	TAYLOR	0	300	300	300	300	300	300
G	224	THROCKMORTON	0	0	0	0	0	0	0
G	239	WASHINGTON	0	0	0	0	0	0	0
G	246	WILLIAMSON (P)	0	0	0	0	0	0	0
G	252	YOUNG (P)	2,300	3,000	3,500	3,500	3,500	3,500	3,500
			57,657	103,020	156,076	174,324	179,324	189,324	202,824
H	8	AUSTIN	0	0	0	0	0	0	0
H	20	BRAZORIA	0	0	0	0	0	0	0
H	36	CHAMBERS	1,103	1,100	1,100	1,100	1,100	1,500	5,000
H	79	FORT BEND	62,805	70,000	70,000	70,000	70,000	70,000	70,000
H	84	GALVESTON	1,229	1,500	1,500	1,500	1,500	1,500	1,500
H	101	HARRIS	11,660	16,500	17,500	20,000	22,500	22,500	22,500
H	145	LEON	0	0	0	0	0	0	0
H	146	LIBERTY	0	0	0	0	0	0	0
H	157	MADISON	0	0	0	0	0	0	0
H	170	MONTGOMERY	5,921	6,000	6,000	6,000	6,000	6,000	6,000
H	187	POLK (P)	0	0	0	0	0	0	0
H	204	SAN JACINTO	0	0	0	0	0	0	0
H	228	TRINITY (P)	0	0	0	0	0	0	0
H	236	WALKER	0	0	0	0	0	0	0
H	237	WALLER	0	0	0	0	0	0	0
			82,718	95,100	96,100	98,600	101,100	101,500	105,000

**2002 STATE WATER PLAN
STEAM ELECTRIC WATER DEMAND PROJECTIONS (acre feet)**

REGION	CNTY	NAME	d1990	d2000	d2010	d2020	d2030	d2040	d2050
State Total		TEXAS	425,945	607,527	831,301	917,994	1,007,424	1,057,929	1,134,644
I	1	ANDERSON	0	0	11,209	11,209	11,209	11,209	11,209
I	3	ANGELINA	0	0	0	0	0	0	0
I	37	CHEROKEE	4,936	5,000	5,000	10,000	15,000	15,000	20,000
I	100	HARDIN	0	0	0	0	0	0	0
I	107	HENDERSON (P)	0	0	0	0	0	0	0
I	113	HOUSTON	0	0	0	0	0	0	0
I	121	JASPER	0	0	0	0	0	0	0
I	123	JEFFERSON	1,021	3,000	6,000	6,000	6,000	6,000	6,000
I	174	NACOGDOCHES	0	0	0	0	7,505	7,505	7,505
I	176	NEWTON	0	0	11,200	11,200	11,200	11,200	11,200
I	181	ORANGE	5,574	6,000	10,000	15,000	20,000	25,000	30,000
I	183	PANOLA	0	0	0	0	0	0	0
I	187	POLK (P)	0	0	0	0	0	0	0
I	201	RUSK	28,320	30,000	35,000	40,000	45,000	45,000	45,000
I	202	SABINE	0	0	0	0	0	0	0
I	203	SAN AUGUSTINE	0	0	0	0	0	0	0
I	210	SHELBY	0	0	0	0	0	0	0
I	212	SMITH (P)	0	0	0	0	0	0	0
I	228	TRINITY (P)	0	0	0	0	0	0	0
I	229	TYLER	0	0	5,000	10,000	15,000	20,000	25,000
			39,851	44,000	83,409	103,409	130,914	140,914	155,914
J	10	BANDERA	0	0	0	0	0	0	0
J	69	EDWARDS	0	0	0	0	0	0	0
J	133	KERR	0	0	0	0	0	0	0
J	136	KINNEY	0	0	0	0	0	0	0
J	193	REAL	0	0	0	0	0	0	0
J	233	VAL VERDE	0	0	0	0	0	0	0
K	11	BASTROP	2,967	4,500	8,000	8,000	8,000	8,000	8,000
K	16	BLANCO	0	0	0	0	0	0	0
K	27	BURNET	0	0	0	0	0	0	0
K	45	COLORADO	0	0	0	0	0	0	0
K	75	FAYETTE	11,701	15,000	20,000	25,000	40,000	40,000	45,000
K	86	GILLESPIE	0	0	0	0	0	0	0
K	105	HAYS (P)	0	0	0	0	0	0	0
K	150	LLANO	937	1,000	2,000	2,000	2,000	2,000	2,000
K	161	MATAGORDA	35,915	47,000	47,000	47,000	47,000	47,000	47,000
K	167	MILLS	0	0	0	0	0	0	0
K	206	SAN SABA	0	0	0	0	0	0	0
K	227	TRAVIS	4,150	13,500	13,500	13,500	13,500	13,500	16,500
K	241	WHARTON (P)	0	0	0	0	0	0	0
K	246	WILLIAMSON (P)	0	0	0	0	0	0	0
			55,670	81,000	90,500	95,500	110,500	110,500	118,500
L	7	ATASCOSA	6,036	12,000	12,000	12,000	12,000	15,000	22,000
L	15	BEXAR	24,263	36,000	36,000	40,000	45,000	50,000	56,000
L	28	CALDWELL	0	0	0	0	0	0	0
L	29	CALHOUN	62	100	100	100	100	100	100
L	46	COMAL	0	0	0	0	0	0	0
L	62	DEWITT	0	0	0	0	0	0	0
L	64	DIMITT	0	0	0	0	0	0	0
L	82	FRIO	38	400	400	400	400	400	400
L	88	GOLIAD	12,165	15,000	15,000	20,000	20,000	20,000	20,000
L	89	GONZALES	0	0	0	0	0	0	0
L	94	GUADALUPE	0	10,760	10,760	10,760	10,760	10,760	10,760

**2002 STATE WATER PLAN
STEAM ELECTRIC WATER DEMAND PROJECTIONS (acre feet)**

REGION	CNTY	NAME	d1990	d2000	d2010	d2020	d2030	d2040	d2050
State Total		TEXAS	425,945	607,527	831,301	917,994	1,007,424	1,057,929	1,134,644
L	105	HAYS (P)	0	0	6,400	6,400	6,400	6,400	6,400
L	128	KARNES	0	0	0	0	0	0	0
L	130	KENDALL	0	0	0	0	0	0	0
L	142	LA SALLE	0	0	0	0	0	0	0
L	163	MEDINA	0	0	0	0	0	0	0
L	196	REFUGIO	0	0	0	0	0	0	0
L	232	UVALDE	0	0	0	0	0	0	0
L	235	VICTORIA	887	8,000	10,000	10,000	10,000	10,000	10,000
L	247	WILSON	0	0	0	0	0	0	0
L	254	ZAVALA	0	0	0	0	0	0	0
			43,451	82,260	90,660	99,660	104,660	112,660	125,660
M	31	CAMERON	1,650	2,400	2,000	2,000	11,600	11,600	11,600
M	108	HIDALGO	1,539	4,700	5,500	6,000	6,000	7,000	7,000
M	124	JIM HOGG	0	0	0	0	0	0	0
M	162	MAVERICK	0	0	0	0	0	0	0
M	214	STARR	0	0	0	0	0	0	0
M	240	WEBB	1,504	2,000	3,900	3,900	5,800	5,800	5,800
M	245	WILLACY	0	0	0	0	0	0	0
M	253	ZAPATA	0	0	0	0	0	0	0
			4,693	9,100	11,400	11,900	23,400	24,400	24,400
N	4	ARANSAS	0	0	0	0	0	0	0
N	13	BEE	0	0	0	0	0	0	0
N	24	BROOKS	0	0	0	0	0	0	0
N	66	DUVAL	0	0	0	0	0	0	0
N	125	JIM WELLS	0	0	0	0	0	0	0
N	131	KENEDY	0	0	0	0	0	0	0
N	137	KLEBERG	0	0	0	0	0	0	0
N	149	LIVE OAK	0	0	0	0	0	0	0
N	156	MCMULLEN	0	0	0	0	0	0	0
N	178	NUECES	2,404	3,300	3,300	3,300	3,300	3,300	3,300
N	205	SAN PATRICIO	0	0	0	0	0	0	0
			2,404	3,300	3,300	3,300	3,300	3,300	3,300
O	9	BAILEY	0	0	0	0	0	0	0
O	23	BRISCOE	0	0	0	0	0	0	0
O	35	CASTRO	0	0	0	0	0	0	0
O	40	COCHRAN	0	0	0	0	0	0	0
O	54	CROSBY	0	0	0	0	0	0	0
O	58	DAWSON	0	0	0	0	0	0	0
O	59	DEAF SMITH	0	0	0	0	0	0	0
O	63	DICKENS	0	0	0	0	0	0	0
O	77	FLOYD	0	0	0	0	0	0	0
O	83	GAINES	0	0	0	0	0	0	0
O	85	GARZA	0	0	0	0	0	0	0
O	95	HALE	0	0	0	0	0	0	0
O	110	HOCKLEY	0	0	0	0	0	0	0
O	140	LAMB	12,587	18,000	18,000	25,000	25,000	25,000	30,000
O	152	LUBBOCK	1,715	2,000	2,000	5,000	5,000	5,000	5,000
O	153	LYNN	0	0	0	0	0	0	0
O	173	MOTLEY	0	0	0	0	0	0	0
O	185	PARMER	0	0	0	0	0	0	0
O	219	SWISHER	0	0	0	0	0	0	0
O	223	TERRY	0	0	0	0	0	0	0
O	251	YOAKUM	0	2,200	2,200	2,200	2,200	2,200	2,200
			14,302	22,200	22,200	32,200	32,200	32,200	37,200

**2002 STATE WATER PLAN
STEAM ELECTRIC WATER DEMAND PROJECTIONS (acre feet)**

REGION	CNTY	NAME	d1990	d2000	d2010	d2020	d2030	d2040	d2050
State Total		TEXAS	425,945	607,527	831,301	917,994	1,007,424	1,057,929	1,134,644
P	120	JACKSON	0	0	0	0	0	0	0
P	143	LAVACA	0	0	0	0	0	0	0
P	241	WHARTON (P)	0	0	0	0	0	0	0
			0	0	0	0	0	0	0

**2002 STATE WATER PLAN
STEAM ELECTRIC WATER SUPPLY PROJECTIONS (acre feet)**

REGION	CNTY	NAME	d2000	d2010	d2020	d2030	d2040	d2050
State Total		TEXAS	1,100,011	1,122,112	1,131,670	1,110,766	1,094,977	1,088,695
A	6	ARMSTRONG	0	0	0	0	0	0
A	33	CARSON	0	0	0	0	0	0
A	38	CHILDRESS	0	0	0	0	0	0
A	44	COLLINGSWORTH	0	0	0	0	0	0
A	56	DALLAM	0	0	0	0	0	0
A	65	DONLEY	0	0	0	0	0	0
A	90	GRAY	0	0	0	0	0	0
A	96	HALL	0	0	0	0	0	0
A	98	HANSFORD	0	0	0	0	0	0
A	103	HARTLEY	0	0	0	0	0	0
A	106	HEMPHILL	0	0	0	0	0	0
A	117	HUTCHINSON	0	0	0	0	0	0
A	148	LIPSCOMB	0	0	0	0	0	0
A	171	MOORE	200	200	200	0	0	0
A	179	OCHILTREE	0	0	0	0	0	0
A	180	OLDHAM	0	0	0	0	0	0
A	188	POTTER	18,300	22,432	25,387	26,804	16,114	14,151 Reuse
A	191	RANDALL	0	0	0	0	0	0
A	197	ROBERTS	0	0	0	0	0	0
A	211	SHERMAN	0	0	0	0	0	0
A	242	WHEELER	0	0	0	0	0	0
			18,500	22,632	25,587	26,804	16,114	14,151
B	5	ARCHER	14,000	14,000	14,000	14,000	14,000	14,000
B	12	BAYLOR	0	0	0	0	0	0
B	39	CLAY	0	0	0	0	0	0
B	51	COTTLE	0	0	0	0	0	0
B	78	FOARD	0	0	0	0	0	0
B	99	HARDEMAN	1,655	1,601	1,548	1,494	1,440	1,387
B	135	KING	0	0	0	0	0	0
B	169	MONTAGUE	0	0	0	0	0	0
B	243	WICHITA	360	360	360	360	360	360
B	244	WILBARGER	20,000	20,000	20,000	20,000	20,000	20,000
B	252	YOUNG (P)	0	0	0	0	0	0
			36,015	35,961	35,908	35,854	35,800	35,747
C	43	COLLIN	5,023	4,436	3,781	3,390	3,090	2,898
C	49	COOKE	0	0	0	0	0	0
C	57	DALLAS	18,109	17,177	15,489	16,533	16,546	7,022
C	61	DENTON	500	500	500	500	500	500
C	70	ELLIS	0	0	0	0	0	0
C	74	FANNIN	10,596	10,596	10,596	10,596	10,596	10,596
C	81	FREESTONE	18,204	18,204	18,204	18,204	18,204	18,204
C	91	GRAYSON	0	0	0	0	0	0
C	107	HENDERSON (P)	13,501	13,501	13,501	13,501	13,501	13,501
C	119	JACK	0	0	0	0	0	0
C	129	KAUFMAN	0	0	0	0	0	0
C	175	NAVARRO	0	0	0	0	0	0
C	184	PARKER	220	204	191	177	163	150
C	199	ROCKWALL	0	0	0	0	0	0
C	220	TARRANT	7,389	7,499	9,589	9,040	9,993	9,453

**2002 STATE WATER PLAN
STEAM ELECTRIC WATER SUPPLY PROJECTIONS (acre feet)**

REGION	CNTY	NAME	d2000	d2010	d2020	d2030	d2040	d2050
State Total		TEXAS	1,100,011	1,122,112	1,131,670	1,110,766	1,094,977	1,088,695
C	249	WISE	0	0	0	0	0	0
			73,542	72,117	71,851	71,941	72,593	62,324
D	19	BOWIE	0	0	0	0	0	0
D	32	CAMP	0	0	0	0	0	0
D	34	CASS	0	0	0	0	0	0
D	60	DELTA	0	0	0	0	0	0
D	80	FRANKLIN	0	0	0	0	0	0
D	92	GREGG	4,686	5,186	5,186	5,186	5,186	6,186
D	102	HARRISON	29,000	29,000	29,000	29,000	29,000	29,000
D	112	HOPKINS	0	0	0	0	0	0
D	116	HUNT	800	0	0	0	0	0
D	139	LAMAR	12,209	12,209	12,209	12,209	12,209	12,209
D	158	MARION	6,700	6,700	6,700	6,700	6,700	6,700
D	172	MORRIS	12,000	12,000	12,000	12,000	12,000	12,000
D	190	RAINS						
D	194	RED RIVER	11,500	11,500	11,500	11,500	11,500	11,500
D	212	SMITH (P)	0	0	0	0	0	0
D	225	TITUS	45,000	45,000	45,000	37,300	37,300	37,300
D	230	UPSHUR	0	0	0	0	0	0
D	234	VAN ZANDT	0	0	0	0	0	0
D	250	WOOD	0	7,500	7,500	7,500	7,500	7,500
			121,895	129,095	129,095	121,395	121,395	122,395
E	22	BREWSTER	0	0	0	0	0	0
E	55	CULBERSON	0	0	0	0	0	0
E	71	EL PASO	6,000	6,000	6,000	0	0	0 Reuse
E	115	HUDSPETH	0	0	0	0	0	0
E	122	JEFF DAVIS	0	0	0	0	0	0
E	189	PRESIDIO	0	0	0	0	0	0
E	222	TERRELL	0	0	0	0	0	0
			6,000	6,000	6,000	0	0	0
F	2	ANDREWS	0	0	0	0	0	0
F	17	BORDEN	0	0	0	0	0	0
F	25	BROWN	0	0	0	0	0	0
F	41	COKE	1,000	1,000	1,000	1,000	1,000	1,000
F	42	COLEMAN	0	0	0	0	0	0
F	48	CONCHO	0	0	0	0	0	0
F	52	CRANE	0	0	0	0	0	0
F	53	CROCKETT	2,391	2,391	2,391	2,391	2,391	2,391
F	68	ECTOR	6,700	6,700	6,700	6,700	6,700	6,700
F	87	GLASSCOCK	0	0	0	0	0	0
F	114	HOWARD	2,024	2,024	2,024	2,024	2,024	2,024
F	118	IRION	0	0	0	0	0	0
F	134	KIMBLE	0	0	0	0	0	0
F	151	LOVING	0	0	0	0	0	0
F	154	MCCULLOCH	0	0	0	0	0	0
F	159	MARTIN	0	0	0	0	0	0
F	160	MASON	0	0	0	0	0	0
F	164	MENARD	0	0	0	0	0	0
F	165	MIDLAND	0	0	0	0	0	0

**2002 STATE WATER PLAN
STEAM ELECTRIC WATER SUPPLY PROJECTIONS (acre feet)**

REGION	CNTY	NAME	d2000	d2010	d2020	d2030	d2040	d2050
State Total		TEXAS	1,100,011	1,122,112	1,131,670	1,110,766	1,094,977	1,088,695
F	168	MITCHELL	3,970	3,943	3,916	3,897	3,882	3,861
F	186	PECOS	6	6	6	6	6	6
F	192	REAGAN	0	0	0	0	0	0
F	195	REEVES	0	0	0	0	0	0
F	200	RUNNELS	0	0	0	0	0	0
F	207	SCHLEICHER	0	0	0	0	0	0
F	208	SCURRY	0	0	0	0	0	0
F	216	STERLING	0	0	0	0	0	0
F	218	SUTTON	0	0	0	0	0	0
F	226	TOM GREEN	1,602	1,524	1,449	1,386	1,298	1,210
F	231	UPTON	0	0	0	0	0	0
F	238	WARD	5,728	5,683	5,680	5,689	5,724	5,763
F	248	WINKLER	0	0	0	0	0	0
			23,421	23,271	23,166	23,093	23,025	22,955
G	14	BELL	0	0	0	0	0	0
G	18	BOSQUE	0	0	0	0	0	0
G	21	BRAZOS	5,756	5,756	5,756	5,756	5,756	5,756
G	26	BURLESON	0	0	0	0	0	0
G	30	CALLAHAN	0	0	0	0	0	0
G	47	COMANCHE	0	0	0	0	0	0
G	50	CORYELL	0	0	0	0	0	0
G	67	EASTLAND	0	0	0	0	0	0
G	72	ERATH	0	0	0	0	0	0
G	73	FALLS	0	0	0	0	0	0
G	76	FISHER	0	0	0	0	0	0
G	93	GRIMES	10,000	20,000	20,000	20,000	20,000	20,000
G	97	HAMILTON	0	0	0	0	0	0
G	104	HASKELL	1,465	1,407	1,349	1,291	1,233	1,175
G	109	HILL	0	0	0	0	0	0
G	111	HOOD	40,000	40,000	40,000	40,000	40,000	39,905
G	126	JOHNSON	0	0	0	0	0	0
G	127	JONES	6,500	6,500	6,500	6,500	6,500	6,500
G	132	KENT	0	0	0	0	0	0
G	138	KNOX	0	0	0	0	0	0
G	141	LAMPASAS	0	0	0	0	0	0
G	144	LEE	0	0	0	0	0	0
G	147	LIMESTONE	27,458	27,458	27,458	27,458	27,458	27,458
G	155	MCLENNAN	16,858	16,858	20,000	25,000	30,000	35,000
G	166	MILAM	9,002	9,002	9,002	9,002	9,002	9,002
G	177	NOLAN	0	0	0	0	0	0
G	182	PALO PINTO	87,296	79,176	74,034	69,034	59,034	49,034
G	198	ROBERTSON	35,807	38,727	40,727	40,727	45,727	50,727
G	209	SHACKELFORD	0	0	0	0	0	0
G	213	SOMERVELL	18,000	23,200	23,200	23,200	23,200	23,200
G	215	STEPHENS	0	0	0	0	0	0
G	217	STONEWALL	0	0	0	0	0	0
G	221	TAYLOR	2,619	2,619	2,619	2,619	2,619	2,619
G	224	THROCKMORTON	0	0	0	0	0	0
G	239	WASHINGTON	0	0	0	0	0	0
G	246	WILLIAMSON (P)	0	0	0	0	0	0
G	252	YOUNG (P)	0	0	0	0	0	0

**2002 STATE WATER PLAN
STEAM ELECTRIC WATER SUPPLY PROJECTIONS (acre feet)**

REGION	CNTY	NAME	d2000	d2010	d2020	d2030	d2040	d2050	
State Total		TEXAS	1,100,011	1,122,112	1,131,670	1,110,766	1,094,977	1,088,695	
			260,761	270,703	270,645	270,587	270,529	270,376	
H	8	AUSTIN	0	0	0	0	0	0	
H	20	BRAZORIA	0	0	0	0	0	0	0 Salt
H	36	CHAMBERS	1,120	1,142	1,142	1,142	1,135	1,170	30,000
H	79	FORT BEND	104,400	104,400	104,400	104,400	104,400	104,400	
H	84	GALVESTON	1,820	1,820	1,820	1,820	1,820	1,820	
H	101	HARRIS	48,260	46,610	46,610	46,610	46,610	46,610	
H	145	LEON	0	0	0	0	0	0	
H	146	LIBERTY	0	0	0	0	0	0	
H	157	MADISON	0	0	0	0	0	0	
H	170	MONTGOMERY	12,096	12,096	12,096	12,096	12,096	12,096	
H	187	POLK (P)	0	0	0	0	0	0	
H	204	SAN JACINTO	0	0	0	0	0	0	
H	228	TRINITY (P)	0	0	0	0	0	0	
H	236	WALKER	0	0	0	0	0	0	
H	237	WALLER	0	0	0	0	0	0	
			167,696	166,068	166,068	166,068	166,061	166,096	
I	1	ANDERSON	0	0	0	0	0	0	
I	3	ANGELINA	0	0	0	0	0	0	
I	37	CHEROKEE	5,343	5,343	5,343	5,343	5,343	5,343	
I	100	HARDIN	0	0	0	0	0	0	
I	107	HENDERSON (P)	0	0	0	0	0	0	
I	113	HOUSTON	0	0	0	0	0	0	
I	121	JASPER	0	0	0	0	0	0	
I	123	JEFFERSON	0	0	0	0	0	0	
I	174	NACOGDOCHES	0	0	0	0	0	0	
I	176	NEWTON	0	0	0	0	0	0	
I	181	ORANGE	22,977	22,977	22,977	22,977	22,977	22,977	
I	183	PANOLA	0	0	0	0	0	0	
I	187	POLK (P)	0	0	0	0	0	0	
I	201	RUSK	25,179	25,179	25,179	25,179	25,179	25,179	
I	202	SABINE	0	0	0	0	0	0	
I	203	SAN AUGUSTINE	0	0	0	0	0	0	
I	210	SHELBY	0	0	0	0	0	0	
I	212	SMITH (P)	0	0	0	0	0	0	
I	228	TRINITY (P)	0	0	0	0	0	0	
I	229	TYLER	0	0	0	0	0	0	
			53,499	53,499	53,499	53,499	53,499	53,499	
J	10	BANDERA	0	0	0	0	0	0	
J	69	EDWARDS	0	0	0	0	0	0	
J	133	KERR	0	0	0	0	0	0	
J	136	KINNEY	0	0	0	0	0	0	
J	193	REAL	0	0	0	0	0	0	
J	233	VAL VERDE	0	0	0	0	0	0	
			0	0	0	0	0	0	
K	11	BASTROP	11,750	11,750	11,750	11,750	11,750	11,750	
K	16	BLANCO	0	0	0	0	0	0	
K	27	BURNET	0	0	0	0	0	0	

**2002 STATE WATER PLAN
STEAM ELECTRIC WATER SUPPLY PROJECTIONS (acre feet)**

REGION	CNTY	NAME	d2000	d2010	d2020	d2030	d2040	d2050
State Total		TEXAS	1,100,011	1,122,112	1,131,670	1,110,766	1,094,977	1,088,695
K	45	COLORADO	0	0	0	0	0	0
K	75	FAYETTE	45,613	45,613	45,613	45,613	45,613	45,613
K	86	GILLESPIE						
K	105	HAYS (P)						
K	150	LLANO	15,000	15,000	15,000	15,000	15,000	15,000
K	161	MATAGORDA	47,443	47,443	47,443	47,443	41,763	41,763
K	167	MILLS	0	0	0	0	0	0
K	206	SAN SABA	0	0	0	0	0	0
K	227	TRAVIS	40,859	40,859	40,859	40,859	40,859	40,859
K	241	WHARTON (P)	0	0	0	0	0	0
K	246	WILLIAMSON (P)	0	0	0	0	0	0
			160,665	160,665	160,665	160,665	154,985	154,985
L	7	ATASCOSA	22,000	22,000	22,000	13,496	13,496	13,496
L	15	BEXAR	59,428	59,428	59,428	59,428	59,428	59,428
L	28	CALDWELL	0	0	0	0	0	0
L	29	CALHOUN	100	100	100	100	100	100
L	46	COMAL	0	0	0	0	0	0
L	62	DEWITT	0	0	0	0	0	0
L	64	DIMITT	0	0	0	0	0	0
L	82	FRIO	400	400	400	400	400	400
L	88	GOLIAD	23,567	23,570	23,574	23,577	23,579	23,579
L	89	GONZALES						
L	94	GUADALUPE	9,840	9,840	9,840	9,840	9,840	9,840
L	105	HAYS (P)	2,500	6,436	6,436	6,436	6,436	6,436
L	128	KARNES	0	0	0	0	0	0
L	130	KENDALL	0	0	0	0	0	0
L	142	LA SALLE	0	0	0	0	0	0
L	163	MEDINA	0	0	0	0	0	0
L	196	REFUGIO	0	0	0	0	0	0
L	232	UVALDE	0	0	0	0	0	0
L	235	VICTORIA	10,000	10,000	10,000	10,000	10,000	10,000
L	247	WILSON	0	0	0	0	0	0
L	254	ZAVALA	0	0	0	0	0	0
			127,835	131,774	131,778	123,277	123,279	123,279
M	31	CAMERON	2,400	2,400	2,400	2,400	2,400	2,400
M	108	HIDALGO	17,289	17,289	17,289	17,289	17,289	17,289
M	124	JIM HOGG	0	0	0	0	0	0
M	162	MAVERICK	0	0	0	0	0	0
M	214	STARR	0	0	0	0	0	0
M	240	WEBB	2,195	2,195	2,195	2,195	2,195	2,195
M	245	WILLACY	0	0	0	0	0	0
M	253	ZAPATA	0	0	0	0	0	0
			21,884	21,884	21,884	21,884	21,884	21,884
N	4	ARANSAS	0	0	0	0	0	0
N	13	BEE	0	0	0	0	0	0
N	24	BROOKS	0	0	0	0	0	0
N	66	DUVAL	0	0	0	0	0	0
N	125	JIM WELLS	0	0	0	0	0	0
N	131	KENEDY	0	0	0	0	0	0

**2002 STATE WATER PLAN
STEAM ELECTRIC WATER SUPPLY PROJECTIONS (acre feet)**

REGION	CNTY	NAME	d2000	d2010	d2020	d2030	d2040	d2050
State Total		TEXAS	1,100,011	1,122,112	1,131,670	1,110,766	1,094,977	1,088,695
N	137	KLEBERG	0	0	0	0	0	0
N	149	LIVE OAK	0	0	0	0	0	0
N	156	MCMULLEN	0	0	0	0	0	0
N	178	NUECES	3,300	3,300	3,300	3,300	3,300	3,300
N	205	SAN PATRICIO	0	0	0	0	0	0
			3,300	3,300	3,300	3,300	3,300	3,300
O	9	BAILEY	0	0	0	0	0	0
O	23	BRISCOE	0	0	0	0	0	0
O	35	CASTRO	0	0	0	0	0	0
O	40	COCHRAN	0	0	0	0	0	0
O	54	CROSBY	0	0	0	0	0	0
O	58	DAWSON	0	0	0	0	0	0
O	59	DEAF SMITH	0	0	0	0	0	0
O	63	DICKENS	0	0	0	0	0	0
O	77	FLOYD	0	0	0	0	0	0
O	83	GAINES	0	0	0	0	0	0
O	85	GARZA	0	0	0	0	0	0
O	95	HALE	0	0	0	0	0	0
O	110	HOCKLEY	0	0	0	0	0	0
O	140	LAMB	18,000	18,000	25,000	25,000	25,000	30,000
O	152	LUBBOCK	4,799	4,944	5,025	5,200	5,314	5,505 Reuse
O	153	LYNN	0	0	0	0	0	0
O	173	MOTLEY	0	0	0	0	0	0
O	185	PARMER	0	0	0	0	0	0
O	219	SWISHER	0	0	0	0	0	0
O	223	TERRY	0	0	0	0	0	0
O	251	YOAKUM	2,200	2,200	2,200	2,200	2,200	2,200
			24,999	25,144	32,225	32,400	32,514	37,705
P	120	JACKSON	0	0	0	0	0	0
P	143	LAVACA	0	0	0	0	0	0
P	241	WHARTON (P)	0	0	0	0	0	0
			0	0	0	0	0	0

**2002 STATE WATER PLAN
STEAM ELECTRIC WATER SUPPLY VERSUS DEMAND
PROJECTIONS (acre feet)**

REGION	CNTY	NAME	d2000	d2010	d2020	d2030	d2040	d2050
State Total		TEXAS	492,484	290,811	213,676	103,342	37,048	-45,949
A	6	ARMSTRONG	0	0	0	0	0	0
A	33	CARSON	0	0	0	0	0	0
A	38	CHILDRESS	0	0	0	0	0	0
A	44	COLLINGSWORTH	0	0	0	0	0	0
A	56	DALLAM	0	0	0	0	0	0
A	65	DONLEY	0	0	0	0	0	0
A	90	GRAY	0	0	0	0	0	0
A	96	HALL	0	0	0	0	0	0
A	98	HANSFORD	0	0	0	0	0	0
A	103	HARTLEY	0	0	0	0	0	0
A	106	HEMPHILL	0	0	0	0	0	0
A	117	HUTCHINSON	0	0	0	0	0	0
A	148	LIPSCOMB	0	0	0	0	0	0
A	171	MOORE	0	0	0	-200	-200	-200
A	179	OCHILTREE	0	0	0	0	0	0
A	180	OLDHAM	0	0	0	0	0	0
A	188	POTTER	0	0	0	0	-12,294	-15,860
A	191	RANDALL	0	0	0	0	0	0
A	197	ROBERTS	0	0	0	0	0	0
A	211	SHERMAN	0	0	0	0	0	0
A	242	WHEELER	0	0	0	0	0	0
			0	0	0	-200	-12,494	-16,060
B	5	ARCHER	14,000	0	0	0	0	0
B	12	BAYLOR	0	0	0	0	0	0
B	39	CLAY	0	0	0	0	0	0
B	51	COTTLE	0	0	0	0	0	0
B	78	FOARD	0	0	0	0	0	0
B	99	HARDEMAN	655	601	548	494	440	387
B	135	KING	0	0	0	0	0	0
B	169	MONTAGUE	0	0	0	0	0	0
B	243	WICHITA	0	0	0	0	0	0
B	244	WILBARGER	11,900	8,000	4,000	0	0	0
B	252	YOUNG (P)	0	0	0	0	0	0
			26,555	8,601	4,548	494	440	387
C	43	COLLIN	3,023	-2,564	-3,219	-3,610	-6,910	-7,102
C	49	COOKE	0	0	0	0	0	0
C	57	DALLAS	109	-2,823	-9,511	-8,467	-8,454	-17,978
C	61	DENTON	500	-4,000	-4,000	-4,000	-5,500	-5,500
C	70	ELLIS	0	-15,000	-15,000	-15,000	-18,000	-18,000
C	74	FANNIN	5,596	4,596	3,596	2,596	1,596	596
C	81	FREESTONE	2,204	-8,796	-10,796	-10,796	-14,988	-14,988
C	91	GRAYSON	0	0	0	0	0	0

**2002 STATE WATER PLAN
STEAM ELECTRIC WATER SUPPLY VERSUS DEMAND
PROJECTIONS (acre feet)**

REGION	CNTY	NAME	d2000	d2010	d2020	d2030	d2040	d2050
State Total		TEXAS	492,484	290,811	213,676	103,342	37,048	-45,949
C	107	HENDERSON (P)	9,501	9,501	9,501	9,501	9,501	9,501
C	119	JACK	0	0	0	0	0	0
C	129	KAUFMAN	-7,800	-8,000	-8,000	-10,000	-10,000	-15,000
C	175	NAVARRO	0	0	0	0	0	0
C	184	PARKER	220	-5,796	-5,809	-9,823	-11,837	-11,850
C	199	ROCKWALL	0	-5,600	-6,000	-6,000	-6,000	-6,000
C	220	TARRANT	389	-501	-411	-960	-1,807	-2,347
C	249	WISE	0	-11,200	-11,200	-11,200	-11,200	-11,200
			13,742	-50,183	-60,849	-67,759	-83,599	-99,868
D	19	BOWIE	0	0	0	0	0	0
D	32	CAMP	0	0	0	0	0	0
D	34	CASS	0	0	0	0	0	0
D	60	DELTA	0	0	0	0	0	0
D	80	FRANKLIN	0	0	0	0	0	0
D	92	GREGG	3,435	3,935	3,935	3,935	3,935	4,935
D	102	HARRISON	23,240	23,240	23,240	23,240	23,240	23,240
D	112	HOPKINS	0	0	0	0	0	0
D	116	HUNT	284	-516	-516	-516	-516	-516
D	139	LAMAR	0	0	0	0	0	0
D	158	MARION	3,832	3,832	3,832	3,832	3,832	3,832
D	172	MORRIS	11,952	11,952	11,952	11,952	11,952	11,952
D	190	RAINS						
D	194	RED RIVER	10,000	6,500	4,500	1,500	1,500	1,500
D	212	SMITH (P)	0	0	0	0	0	0
D	225	TITUS	16,720	13,720	13,720	1,020	1,020	1,020
D	230	UPSHUR	0	-5,601	-5,601	-5,601	-5,601	-5,601
D	234	VAN ZANDT	0	0	0	0	0	0
D	250	WOOD	0	0	0	0	0	-7,500
			69,463	57,062	55,062	39,362	39,362	32,862
E	22	BREWSTER	0	0	0	0	0	0
E	55	CULBERSON	0	0	0	0	0	0
E	71	EL PASO	0	0	0	-6,000	-6,000	-6,000
E	115	HUDSPETH	0	0	0	0	0	0
E	122	JEFF DAVIS	0	0	0	0	0	0
E	189	PRESIDIO	0	0	0	0	0	0
E	222	TERRELL	0	0	0	0	0	0
			0	0	0	-6,000	-6,000	-6,000
F	2	ANDREWS	0	0	0	0	0	0
F	17	BORDEN	0	0	0	0	0	0
F	25	BROWN	0	0	0	0	0	0
F	41	COKE	165	165	165	165	165	165
F	42	COLEMAN	0	0	0	0	0	0

**2002 STATE WATER PLAN
STEAM ELECTRIC WATER SUPPLY VERSUS DEMAND
PROJECTIONS (acre feet)**

REGION	CNTY	NAME	d2000	d2010	d2020	d2030	d2040	d2050
State Total		TEXAS	492,484	290,811	213,676	103,342	37,048	-45,949
F	48	CONCHO	0	0	0	0	0	0
F	52	CRANE	0	0	0	0	0	0
F	53	CROCKETT	477	-1,889	-1,889	-1,889	-1,889	-1,889
F	68	ECTOR	0	0	0	0	0	0
F	87	GLASSCOCK	0	0	0	0	0	0
F	114	HOWARD	644	644	644	644	644	644
F	118	IRION	0	0	0	0	0	0
F	134	KIMBLE	0	0	0	0	0	0
F	151	LOVING	0	0	0	0	0	0
F	154	MCCULLOCH	0	0	0	0	0	0
F	159	MARTIN	0	0	0	0	0	0
F	160	MASON	0	0	0	0	0	0
F	164	MENARD	0	0	0	0	0	0
F	165	MIDLAND	0	0	0	0	0	0
F	168	MITCHELL	-30	-457	-1,364	-2,439	-3,721	-5,263
F	186	PECOS	0	0	0	0	0	0
F	192	REAGAN	0	0	0	0	0	0
F	195	REEVES	0	0	0	0	0	0
F	200	RUNNELS	0	0	0	0	0	0
F	207	SCHLEICHER	0	0	0	0	0	0
F	208	SCURRY	0	0	0	0	0	0
F	216	STERLING	0	0	0	0	0	0
F	218	SUTTON	0	0	0	0	0	0
F	226	TOM GREEN	582	-2,156	-2,231	-2,294	-2,382	-2,470
F	231	UPTON	0	0	0	0	0	0
F	238	WARD	228	-367	-1,580	-3,023	-4,730	-6,782
F	248	WINKLER	0	0	0	0	0	0
			2,066	-4,060	-6,255	-8,836	-11,913	-15,595
G	14	BELL	0	-11,200	-11,200	-11,200	-11,200	-11,200
G	18	BOSQUE	0	-5,600	-5,600	-5,600	-5,600	-5,600
G	21	BRAZOS	756	756	756	756	756	756
G	26	BURLESON	0	0	0	0	0	0
G	30	CALLAHAN	0	0	0	0	0	0
G	47	COMANCHE	0	0	0	0	0	0
G	50	CORYELL	0	0	0	0	0	0
G	67	EASTLAND	0	0	0	0	0	0
G	72	ERATH	0	0	0	0	0	0
G	73	FALLS	0	0	0	0	0	0
G	76	FISHER	0	0	0	0	0	0
G	93	GRIMES	0	0	0	0	0	0
G	97	HAMILTON	0	0	0	0	0	0
G	104	HASKELL	765	-933	-1,651	-1,709	-1,767	-1,825
G	109	HILL	0	0	0	0	0	0
G	111	HOOD	35,500	33,300	33,300	33,300	33,300	33,205

**2002 STATE WATER PLAN
STEAM ELECTRIC WATER SUPPLY VERSUS DEMAND
PROJECTIONS (acre feet)**

REGION	CNTY	NAME	d2000	d2010	d2020	d2030	d2040	d2050
State Total		TEXAS	492,484	290,811	213,676	103,342	37,048	-45,949
G	126	JOHNSON	0	0	0	0	0	0
G	127	JONES	4,160	2,944	-3,824	-3,824	-3,824	-3,824
G	132	KENT	0	0	0	0	0	0
G	138	KNOX	0	0	0	0	0	0
G	141	LAMPASAS	0	0	0	0	0	0
G	144	LEE	0	0	0	0	0	0
G	147	LIMESTONE	9,458	7,458	7,458	7,458	7,458	7,458
G	155	MCLENNAN	1,858	1,858	0	0	0	0
G	166	MILAM	322	322	-3,498	-3,498	-3,498	-6,998
G	177	NOLAN	0	0	0	0	0	0
G	182	PALO PINTO	84,796	76,176	71,034	66,034	56,034	46,034
G	198	ROBERTSON	20,807	10,727	10,727	10,727	10,727	10,727
G	209	SHACKELFORD	0	0	0	0	0	0
G	213	SOMERVELL	0	0	0	0	0	0
G	215	STEPHENS	0	0	0	0	0	0
G	217	STONEWALL	0	0	0	0	0	0
G	221	TAYLOR	2,319	2,319	2,319	2,319	2,319	2,319
G	224	THROCKMORTON	0	0	0	0	0	0
G	239	WASHINGTON	0	0	0	0	0	0
G	246	WILLIAMSON (P)	0	0	0	0	0	0
G	252	YOUNG (P)	-3,000	-3,500	-3,500	-3,500	-3,500	-3,500
			157,741	114,627	96,321	91,263	81,205	67,552
H	8	AUSTIN	0	0	0	0	0	0
H	20	BRAZORIA	0	0	0	0	0	0
H	36	CHAMBERS	20	42	42	42	-365	-3,830
H	79	FORT BEND	34,400	34,400	34,400	34,400	34,400	34,400
H	84	GALVESTON	320	320	320	320	320	320
H	101	HARRIS	31,760	29,110	26,610	24,110	24,110	24,110
H	145	LEON	0	0	0	0	0	0
H	146	LIBERTY	0	0	0	0	0	0
H	157	MADISON	0	0	0	0	0	0
H	170	MONTGOMERY	6,096	6,096	6,096	6,096	6,096	6,096
H	187	POLK (P)	0	0	0	0	0	0
H	204	SAN JACINTO	0	0	0	0	0	0
H	228	TRINITY (P)	0	0	0	0	0	0
H	236	WALKER	0	0	0	0	0	0
H	237	WALLER	0	0	0	0	0	0
			72,596	69,968	67,468	64,968	64,561	61,096
I	1	ANDERSON	0	-11,209	-11,209	-11,209	-11,209	-11,209
I	3	ANGELINA	0	0	0	0	0	0
I	37	CHEROKEE	343	343	-4,657	-9,657	-9,657	-14,657
I	100	HARDIN	0	0	0	0	0	0
I	107	HENDERSON (P)	0	0	0	0	0	0

**2002 STATE WATER PLAN
STEAM ELECTRIC WATER SUPPLY VERSUS DEMAND
PROJECTIONS (acre feet)**

REGION	CNTY	NAME	d2000	d2010	d2020	d2030	d2040	d2050
State Total		TEXAS	492,484	290,811	213,676	103,342	37,048	-45,949
I	113	HOUSTON	0	0	0	0	0	0
I	121	JASPER	0	0	0	0	0	0
I	123	JEFFERSON	-3,000	-6,000	-6,000	-6,000	-6,000	-6,000
I	174	NACOGDOCHES	0	0	0	-7,505	-7,505	-7,505
I	176	NEWTON	0	-11,200	-11,200	-11,200	-11,200	-11,200
I	181	ORANGE	16,977	12,977	7,977	2,977	-2,023	-7,023
I	183	PANOLA	0	0	0	0	0	0
I	187	POLK (P)	0	0	0	0	0	0
I	201	RUSK	-4,821	-9,821	-14,821	-19,821	-19,821	-19,821
I	202	SABINE	0	0	0	0	0	0
I	203	SAN AUGUSTINE	0	0	0	0	0	0
I	210	SHELBY	0	0	0	0	0	0
I	212	SMITH (P)	0	0	0	0	0	0
I	228	TRINITY (P)	0	0	0	0	0	0
I	229	TYLER	0	-5,000	-10,000	-15,000	-20,000	-25,000
			9,499	-29,910	-49,910	-77,415	-87,415	-102,415
J	10	BANDERA	0	0	0	0	0	0
J	69	EDWARDS	0	0	0	0	0	0
J	133	KERR	0	0	0	0	0	0
J	136	KINNEY	0	0	0	0	0	0
J	193	REAL	0	0	0	0	0	0
J	233	VAL VERDE	0	0	0	0	0	0
			0	0	0	0	0	0
K	11	BASTROP	7,250	3,750	3,750	3,750	3,750	3,750
K	16	BLANCO	0	0	0	0	0	0
K	27	BURNET	0	0	0	0	0	0
K	45	COLORADO	0	0	0	0	0	0
K	75	FAYETTE	30,613	25,613	20,613	5,613	5,613	613
K	86	GILLESPIE						
K	105	HAYS (P)						
K	150	LLANO	14,000	13,000	13,000	13,000	13,000	13,000
K	161	MATAGORDA	443	443	443	443	-5,237	-5,237
K	167	MILLS	0	0	0	0	0	0
K	206	SAN SABA	0	0	0	0	0	0
K	227	TRAVIS	27,359	27,359	27,359	27,359	27,359	24,359
K	241	WHARTON (P)	0	0	0	0	0	0
K	246	WILLIAMSON (P)	0	0	0	0	0	0
			79,665	70,165	65,165	50,165	44,485	36,485
L	7	ATASCOSA	10,000	10,000	10,000	1,496	-1,504	-8,504
L	15	BEXAR	23,428	23,428	19,428	14,428	9,428	3,428
L	28	CALDWELL	0	0	0	0	0	0
L	29	CALHOUN						

**2002 STATE WATER PLAN
STEAM ELECTRIC WATER SUPPLY VERSUS DEMAND
PROJECTIONS (acre feet)**

REGION	CNTY	NAME	d2000	d2010	d2020	d2030	d2040	d2050
State Total		TEXAS	492,484	290,811	213,676	103,342	37,048	-45,949
L	46	COMAL	0	0	0	0	0	0
L	62	DEWITT	0	0	0	0	0	0
L	64	DIMITT	0	0	0	0	0	0
L	82	FRIO	0	0	0	0	0	0
L	88	GOLIAD	8,567	8,570	3,574	3,577	3,579	3,579
L	89	GONZALES						
L	94	GUADALUPE	-920	-920	-920	-920	-920	-920
L	105	HAYS (P)	2,500	36	36	36	36	36
L	128	KARNES	0	0	0	0	0	0
L	130	KENDALL	0	0	0	0	0	0
L	142	LA SALLE	0	0	0	0	0	0
L	163	MEDINA	0	0	0	0	0	0
L	196	REFUGIO	0	0	0	0	0	0
L	232	UVALDE	0	0	0	0	0	0
L	235	VICTORIA	2,000	0	0	0	0	0
L	247	WILSON	0	0	0	0	0	0
L	254	ZAVALA	0	0	0	0	0	0
			45,575	41,114	32,118	18,617	10,619	-2,381
M	31	CAMERON	0	400	400	-9,200	-9,200	-9,200
M	108	HIDALGO	12,589	11,789	11,289	11,289	10,289	10,289
M	124	JIM HOGG	0	0	0	0	0	0
M	162	MAVERICK	0	0	0	0	0	0
M	214	STARR	0	0	0	0	0	0
M	240	WEBB	195	-1,706	-1,706	-3,606	-3,606	-3,606
M	245	WILLACY	0	0	0	0	0	0
M	253	ZAPATA	0	0	0	0	0	0
			12,784	10,484	9,984	-1,517	-2,517	-2,517
N	4	ARANSAS	0	0	0	0	0	0
N	13	BEE	0	0	0	0	0	0
N	24	BROOKS	0	0	0	0	0	0
N	66	DUVAL	0	0	0	0	0	0
N	125	JIM WELLS	0	0	0	0	0	0
N	131	KENEDY	0	0	0	0	0	0
N	137	KLEBERG	0	0	0	0	0	0
N	149	LIVE OAK	0	0	0	0	0	0
N	156	MCMULLEN	0	0	0	0	0	0
N	178	NUECES	0	0	0	0	0	0
N	205	SAN PATRICIO	0	0	0	0	0	0
			0	0	0	0	0	0
O	9	BAILEY	0	0	0	0	0	0
O	23	BRISCOE	0	0	0	0	0	0
O	35	CASTRO	0	0	0	0	0	0

**2002 STATE WATER PLAN
STEAM ELECTRIC WATER SUPPLY VERSUS DEMAND
PROJECTIONS (acre feet)**

REGION	CNTY	NAME	d2000	d2010	d2020	d2030	d2040	d2050
State Total		TEXAS	492,484	290,811	213,676	103,342	37,048	-45,949
O	40	COCHRAN	0	0	0	0	0	0
O	54	CROSBY	0	0	0	0	0	0
O	58	DAWSON	0	0	0	0	0	0
O	59	DEAF SMITH	0	0	0	0	0	0
O	63	DICKENS	0	0	0	0	0	0
O	77	FLOYD	0	0	0	0	0	0
O	83	GAINES	0	0	0	0	0	0
O	85	GARZA	0	0	0	0	0	0
O	95	HALE	0	0	0	0	0	0
O	110	HOCKLEY	0	0	0	0	0	0
O	140	LAMB	0	0	0	0	0	0
O	152	LUBBOCK	2,799	2,944	25	200	314	505
O	153	LYNN	0	0	0	0	0	0
O	173	MOTLEY	0	0	0	0	0	0
O	185	PARMER	0	0	0	0	0	0
O	219	SWISHER	0	0	0	0	0	0
O	223	TERRY	0	0	0	0	0	0
O	251	YOAKUM	0	0	0	0	0	0
			2,799	2,944	25	200	314	505
P	120	JACKSON	0	0	0	0	0	0
P	143	LAVACA	0	0	0	0	0	0
P	241	WHARTON (P)	0	0	0	0	0	0
			0	0	0	0	0	0

Appendix D
Comparison of Steam Electric Water Supply and
Demand

Annual Statewide Steam Electric Water Supply vs. Demand

Year	Year	TWDB Demand per 2002 SWP	TWDB Supply per 2002 SWP	Study Demand	Study Demand Minus TWDB Supply	TWDB Supply Minus TWDB Demand
2000	1	611,338	1,099,675	621,872	477,803	488,337
2001	1.1	637,065	1,102,764	631,574	471,189	465,699
2002	1.2	661,555	1,105,735	641,370	464,365	444,180
2003	1.3	684,847	1,108,574	651,267	457,307	423,727
2004	1.4	706,980	1,111,268	661,271	449,996	404,288
2005	1.5	727,991	1,113,804	671,392	442,412	385,813
2006	1.6	747,921	1,116,173	681,636	434,537	368,253
2007	1.7	766,806	1,118,364	692,010	426,354	351,559
2008	1.8	784,685	1,120,370	702,524	417,846	335,685
2009	1.9	801,597	1,122,181	713,183	408,998	320,585
2010	2	817,580	1,123,793	723,995	399,797	306,213
2011	2.1	832,672	1,125,199	734,969	390,230	292,527
2012	2.2	846,912	1,126,396	746,111	380,285	279,484
2013	2.3	860,339	1,127,381	757,429	369,951	267,042
2014	2.4	872,990	1,128,151	768,931	359,220	255,161
2015	2.5	884,904	1,128,707	780,624	348,083	243,802
2016	2.6	896,120	1,129,048	792,516	336,532	232,927
2017	2.7	906,676	1,129,175	804,614	324,562	222,499
2018	2.8	916,611	1,129,092	816,925	312,167	212,482
2019	2.9	925,962	1,128,803	829,458	299,344	202,841
2020	3	934,768	1,128,311	842,220	286,091	193,542
2021	3.1	943,068	1,127,622	855,218	272,404	184,554
2022	3.2	950,900	1,126,745	868,460	258,285	175,845
2023	3.3	958,303	1,125,687	881,953	243,733	167,384
2024	3.4	965,314	1,124,456	895,705	228,751	159,143
2025	3.5	971,973	1,123,065	909,724	213,341	151,092
2026	3.6	978,317	1,121,524	924,017	197,507	143,207
2027	3.7	984,385	1,119,845	938,591	181,254	135,460
2028	3.8	990,216	1,118,043	953,454	164,588	127,826
2029	3.9	995,848	1,116,132	968,614	147,518	120,284
2030	4	1,001,319	1,114,128	984,078	130,050	112,809
2031	4.1	1,006,668	1,112,049	999,854	112,195	105,380
2032	4.2	1,011,934	1,109,912	1,015,949	93,963	97,978
2033	4.3	1,017,153	1,107,737	1,032,370	75,367	90,584
2034	4.4	1,022,366	1,105,544	1,049,126	56,418	83,178
2035	4.5	1,027,610	1,103,356	1,066,224	37,132	75,745
2036	4.6	1,032,925	1,101,193	1,083,671	17,522	68,269
2037	4.7	1,038,347	1,099,081	1,101,475	-2,394	60,734
2038	4.8	1,043,916	1,097,044	1,119,643	-22,599	53,128
2039	4.9	1,049,670	1,095,108	1,138,183	-43,075	45,438
2040	5	1,055,648	1,093,300	1,157,102	-63,803	37,652
2041	5.1	1,061,887	1,091,648	1,176,409	-84,761	29,761
2042	5.2	1,068,427	1,090,183	1,196,110	-105,927	21,755
2043	5.3	1,075,306	1,088,933	1,216,213	-127,280	13,627
2044	5.4	1,082,562	1,087,932	1,236,726	-148,794	5,370
2045	5.5	1,090,233	1,087,211	1,257,656	-170,445	-3,022
2046	5.6	1,098,359	1,086,804	1,279,010	-192,206	-11,555
2047	5.7	1,106,977	1,086,747	1,300,797	-214,050	-20,230

Appendix E
Projected Electrical Demand Per State and
Federal Agencies

New Electric Generating Plants in Texas

ERCOT - Electric Reliability Council of Texas
 SERC - Southeastern Electric Reliability Council
 SPP - Southwest Power Pool
 WSCC - Western Systems Coordinating Council

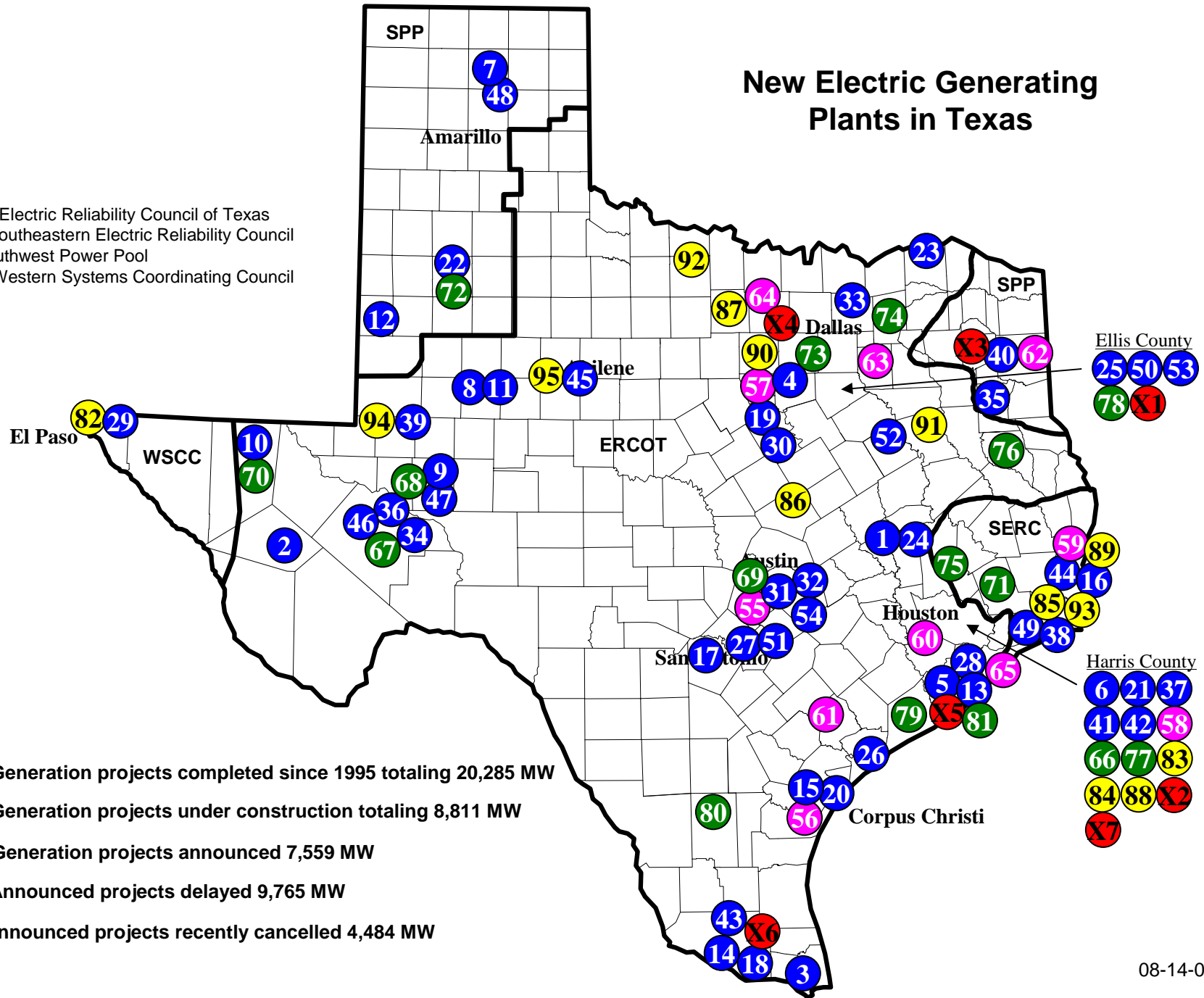

Generation Projects Completed in Texas Since 1995¹

Map No.	Company	Facility	City (County)	Capacity ² (MW)	Cogen Host (MW)	Date in Service	Interconnection	Region
1	Texas A&M University		College Station (Brazos)	40	40	Jan-96	Brazos	ERCOT
2	CSW Services (wind)		Ft. Davis (Jeff Davis)	6.6		Jan-96	WTU	ERCOT
3	City of Brownsville	Silas Ray	Brownsville (Cameron)	43		Jun-96	BPUB	ERCOT
4	Tenaska IV Texas Partners	Tenaska IV Texas Partners	Cleburne (Johnson)	258		Nov-96	TU/BEPC	ERCOT
5	CSW Energy	Sweeny Cogeneration	Sweeny (Brazoria)	330	90	Feb-98	TNMP	ERCOT
6	Calpine/Phillips	Pasadena Power Plant I	Pasadena (Harris)	240	90	Jul-98	Reliant	ERCOT
7	Borger Energy Associates	Black Hawk Station	Borger (Hutchinson)	254 ³	38	Aug-98	SPS	SPP
8	York Research (wind)	Big Spring Wind Power	Big Spring (Howard)	34		Feb-99	TU	ERCOT
9	FPL Energy (wind)	Southwest Mesa Wind Proj.	McCarney (Upton)	75		Jun-99	WTU	ERCOT
10	American National Wind Power (wind)	Delaware Mtn Wind Farm	Delaware Mtn (Culberson)	30		Jun-99	TXU	ERCOT
11	York Research (wind)	Big Spring Wind Power	Big Spring (Howard)	6.6		Jun-99	TXU	ERCOT
12	Golden Spread/LS Power	Mustang Station	Denver City (Yoakum)	280		Jun-99	SPS	SPP
				198		May-00		
13	BASF	Freeport	Freeport (Brazoria)	93		Jul-99	Reliant	ERCOT
14	CSW Energy	Frontera Power Station	Mission (Hidalgo)	344		Jul-99	CPL	ERCOT
				170		May-00		
15	Conoco Global-OxyChem	Ingleside Cogeneration	Ingleside (San Patricio)	440	235	Oct-99	CPL	ERCOT
16	Reliant Energy/Air Liquide/Bayer	Sabine Project	Sabine (Orange)	100 ⁴	36	Dec-99	Entergy	SERC
17	CPS	A. von Rosenberg	San Antonio (Bexar)	500		May-00	CPS	ERCOT
18	Calpine	Hidalgo Energy Center	Edinburg (Hidalgo)	500		Jun-00	CSW	ERCOT
19	Southern Energy	Bosque County Power Plant	Lake Whitney (Bosque)	308		Jun-00	Brazos	ERCOT
20	LG&E/Columbia-Reynolds	Gregory Power Plant	Gregory (San Patricio)	450	50	Jul-00	CSW	ERCOT
21	Calpine	Pasadena Power Plant II	Pasadena (Harris)	540		Jul-00	Reliant	ERCOT
22	Lubbock Power & Light	J. Robert Massengale	Lubbock (Lubbock)	43		Sep-00	LPL	SPP
23	FPL Energy/Panda Energy	Lamar Power Plant	Paris (Lamar)	1000		Sep-00	TXU	ERCOT
24	Tenaska/PECO Power Team	Tenaska Frontier Gen. Sta.	Shirow (Grimes)	830		Sep-00	Reliant/EGS	ERCOT/SERC
25	ANP	Midlothian I	Midlothian (Ellis)	820		Oct-00	TXU	ERCOT
				280		Feb-01		

¹ The Texas Legislature opened the electric wholesale market in Texas to competition on September 1, 1995.

² Wind generation facilities are shown at nameplate capacity rating; however, the actual capacity they provide at the time of peak demand may be substantially less.

³ Approximately 216 MW is under 25-year contract to SPS.

⁴ Sixty megawatts under contract to Alabama Electric Cooperative for three years beginning January 1, 2000.

Generation Projects Completed in Texas Since 1995 (continued)

Map No.	Company	Facility	City (County)	Capacity (MW)	Cogen Host (MW)	Date in Service	Interconnection	Region
26	Union Carbide		Seadrift (Calhoun)	40	40	Nov-00	CPL	ERCOT
27	Texas Independent Energy	Guadalupe Power Plant	Marion (Guadalupe)	1000		Jan-01	LCRA	ERCOT
28	AEP-Phillips	Sweeny (expansion)	Sweeny (Brazoria)	110	35	Jan-01	TNMP	ERCOT
29	Cielo/El Paso Electric (wind)	Hueco Mountain Wind Ranch	Hueco Mtn. (El Paso)	1.3		Apr-01	EPE	WSCC
30	Mirant	Bosque County Power Plant	Lake Whitney (Bosque)	248		Jun-01	Brazos	ERCOT
31	Enron/Austin	Sand Hill Energy Center	Austin (Travis)	180		Jun-01	AE	ERCOT
32	Calpine/Gen Tex Power	Lost Pines I	Lost Pines (Bastrop)	520 ⁵		Jun-01	LCRA/AE	ERCOT
33	Garland Power & Light	Ray Olinger Power Plant	Garland (Collin)	75		Jun-01	GP&L	ERCOT
34	Orion Energy/Amer Nat Wind Pwr (wind)	Indian Mesa I	(Pecos)	82.5		Jun-01	WTU	ERCOT
35	Tenaska/Coral Energy	Tenaska Gateway Gen. Sta.	Henderson (Rusk)	845		Jul-01	TXU/AEP	ERCOT/SERC
36	FPL/Cielo/TXU (wind)	Woodward Mountain Ranch	McCamey (Pecos)	160		Jul-01	WTU	ERCOT
37	Calpine-Lyondell-Citgo	Channel Energy Center	Houston	160 400	160	Jul-01 Apr-02	Reliant	ERCOT
38	Finra BASF		Port Arthur (Jefferson)	80	80	Aug-01	EGS	SERC
39	Texas Independent Energy	Odessa-Ector Power Plant	Odessa (Ector)	1000		Aug-01	TXU	ERCOT
40	AEP/Eastman Chemical		Longview (Harrison)	440	130	Aug-01	SWEPSCO	SPP
41	Exelon/Air Products & Chemicals	ExTex Power Station	La Porte (Harris)	165		Aug-01	Reliant	ERCOT
42	Reliant Energy / Equistar	Reliant Energy Channelview	Channelview (Harris)	172 608	293	Aug-01 Jun-02	Reliant	ERCOT
43	Calpine	Magic Valley Gen. Station	Edinburg (Hidalgo)	350 ⁶ 380		Sep-01 Dec-01	CPL	ERCOT
44	Conoco Global/Dupont	SRW Cogeneration	Orange (Orange)	420 ⁷	70	Nov-01	EGS	SERC
45	AEP (wind)	Trent Mesa	Trent Mesa (Nolan)	150		Nov-01	TXU	ERCOT
46	AEP (wind)	Desert Sky (Indian Mesa II)	Iraan (Pecos)	160		Dec-01	WTU	ERCOT
47	FPL/Cielo (wind)	King Mtn Wind Ranch	McCamey (Upton)	278		Dec-01	WTU	ERCOT
48	Shell Wind Energy (wind)	Llano Estacado Wind Ranch	White Deer (Carson)	79		Jan-02	SPS	SPP
49	Calpine-Bayer	Baytown Power Plant	Baytown (Chambers)	700	300	Apr-02	Reliant	ERCOT

⁵ GenTex is an affiliate of LCRA. Half of plant capacity will serve LCRA; Calpine will sell the remainder.

⁶ Magic Valley Electric Cooperative has contracted to buy 246 MW for 2001, increasing by 25 MW in 2002.

⁷ PG&E Energy Trading will take up to 250 MW over a 10-year period. Approximately 100 MW will be sold into the SERC region.

Generation Projects Completed in Texas Since 1995 (continued)

Map No.	Company	Facility	City (County)	Capacity (MW)	Cogen Host (MW)	Date in Service	Interconnection	Region
50	Tractebel	Ennis Tractebel Power Project	Ennis (Ellis)	343		Jun-02	TXU	ERCOT
51	Constellation Power	Rio Nogales Power Plant	Seguin (Guadalupe)	800		Jun-02	LCRA	ERCOT
52	Calpine	Freestone Energy Center	Fairfield (Freestone)	1040		Jul-02	TXU	ERCOT
53	ANP	Midlothian II	Midlothian (Ellis)	550		Aug-02	TXU	ERCOT
54	FPL Energy/Coastal Power	Bastrop Energy Center	(Bastrop)	535		Aug-02	AE/LCRA	ERCOT
	54 Projects Completed		Total Capacity	20,285	1,687			

Generation Projects Under Construction in Texas

Map No.	Company	Facility	City (County)	Capacity (MW)	Cogen Host (MW)	Date in Service	Interconnection	Region
55	ANP	Hays Station	San Marcos (Hays)	550 550		Aug-02 Complete	LCRA	ERCOT
56	Calpine-Citgo	Corpus Christi Energy Center	Corpus Christi (Nueces)	520	110	Aug-02	CPL	ERCOT
57	AES ⁸	Wolf Hollow Power Plant	Granbury (Hood)	730		Oct-02	TXU	ERCOT
58	Calpine-Shell	Deer Park Energy Center	Deer Park (Harris)	166 169 438	190	Feb-03 Aug-03 Jun-04	Reliant	ERCOT
59	InterGen	Cottonwood Energy Project	Deweyville (Newton)	1200		Apr-03	EGS	SERC
60	NRG Energy	Brazos Valley Energy	Thompsons (Fort Bend)	633		May-03	Reliant	ERCOT
61	South Texas Electric Co-op		Nursery (Victoria)	185		Jun-03	STEC	ERCOT
62	Entergy/NTEC ⁹	Harrison County Gen Station	(Harrison)	550		Jun-03	SWEPSCO	SPP
63	FPL/Cobisa	Fomey	Fomey (Kaufman)	1750		3Q-03	TXU	ERCOT
64	Tractebel	Wise County Power Project	Bridgeport (Wise)	800		Jan-04	TXU	ERCOT
65	BP/Cinergy	Texas City	Texas City (Galveston)	570	NA	Spring-04	TNMP	ERCOT
	11 Under Construction		Total Capacity	8,811	300			

⁸ Twenty-year agreement to sell 350 MW to Exelon Energy Company, and the balance will be marketed by affiliate AES NewEnergy.

⁹ Project is 70% owned by Entergy and 30% owned by Northeast Texas Electric Cooperative.

Announced Generation Projects in Texas

Map No.	Company	Facility	City (County)	Capacity (MW)	Expected Construction Date	Expected Date In Service	Region
66	Reliant/Jenbacher		Humble (Harris) ¹⁰	24 8	Sum-02	Dec-02 Mar-03	ERCOT
67	Cielo/Renewable Energy (wind)	Capital Hill Wind Ranch	(Pecos)	100	Nov-02	Feb-03	ERCOT
68	TXU Energy/Cielo Wind (wind)	Noelke Hill Wind Ranch	McCarney (Upton)	240	Dec-02	Sep -03	ERCOT
69	Austin Energy	Sand Hill	Del Valle (Travis)	300 250	2002	Oct-03 Sum-07	ERCOT
70	Orion Energy (wind)		(Culberson)	175 ¹¹	2002	2003	ERCOT
71	Sempra Energy Resources	Cedar Power Project	Dayton (Liberty)	600	Spring-03	Spring-05	ERCOT/SERC
72	Cielo Wind Power/LPL (wind)	Llano Estacado at Lubbock	Lubbock (Lubbock)	2	Jun-03	Jun-03	SPP
73	DFW Airport		(Tarrant/Dallas)	55 55	2003 2005	2005 2007	ERCOT
74	Cobisa	Greenville	Greenville (Hunt)	1750	Spring-04	Spring-06	ERCOT
75	Sempra Energy Resources	MC Energy Partners	Dobbin (Montgomery)	600	Apr-04	Apr-06	ERCOT/SERC
76	Steag Power	Sterne	(Nacogdoches)	950	2Q-04	2Q-06	ERCOT/SPP
77	Texas Petrochemicals		Houston (Harris)	900	2004	2006	ERCOT
78	Tractebel	Ennis-Tractebel II	Ennis (Ellis)	800	NA	Jun-04	ERCOT
79	Ridge Energy Storage ¹²	Markham Energy Storage Center	(Matagorda)	270	NA	3Q-04	ERCOT
80	CCNG Inc ¹³		San Diego (Duval)	310	NA	2Q-05	ERCOT
81	Dow Chemical		Freeport (Brazoria)	170	NA	Dec-05	ERCOT
	16 Projects Announced		Total Capacity	7,559			

¹⁰ This project consists of 12 landfill gas facilities at different locations between Houston and Dallas. The total capacity is expected to reach 40 MW by 2004.

¹¹ Capacity will be in the range of 175 to 225 MW. Construction will start late 2002 or early 2003.

¹² Compressed air energy storage project.

¹³ Compressed air energy storage project which will require 60 to 70 miles of new transmission.

Delayed Generation Projects¹⁴

Map No.	Company	Facility	City (County)	Capacity (MW)	Expected Construction Date	Expected Date In Service	Region
82	ANP		El Paso (El Paso)	450	NA	NA	WSCC
83	ANP		Houston (Harris)	2150	NA	NA	ERCOT
84	Calpine	Channel Energy Center exp.	Houston (Harris)	180	NA	NA	ERCOT
85	Calpine	Amelia Energy Center	Beaumont (Jefferson)	800	NA	NA	SERC
86	Duke Energy		(Bell)	500	NA	NA	ERCOT
87	Duke Energy		(Jack)	500	NA	NA	ERCOT
88	Dynegy		Lyondell expansion (Harris)	155	NA	NA	ERCOT
89	Hartburg Power		Deweyville (Newton)	800	NA	NA	SERC
90	Mirant		Weatherford (Parker)	650	NA	NA	ERCOT
91	Newport Generation ¹⁵	Palestine Power Project	Palestine (Anderson)	1600	NA	NA	ERCOT
92	Texas Independent Energy	Archer Power Partners	Holliday (Archer)	500 ¹⁶	NA	NA	ERCOT
93	Sabine Power I/Port of Port Arthur		Port Arthur (Jefferson) ¹⁷	1000	NA	NA	SERC
94	York Research Group (wind)	Notrees Wind Farm	(Ector, Winkler)	80	NA	NA	ERCOT
95	Enron Wind ¹⁸		Sweetwater (Nolan)	400	NA	NA	ERCOT
	14 Projects Delayed		Total Capacity	9,765			

¹⁴ An announced project which does not have a projected in-service date is listed as delayed.

¹⁵ Newport is considering interconnection of the project to SPP through the SWEPCO.

¹⁶ Project has been on hold due to lack of transmission into DFW area.

¹⁷ Fuel for this plant would be provided by a petroleum coke gasification facility to be constructed in Port Arthur.

¹⁸ Currently unable to determine the status of this project. Enron Wind is no longer developing it since a portion of its business was sold to GE Power Systems.

Cancelled Projects

Map No.	Company	Facility	City (County)	Capacity (MW)	Year Cancelled	Region
X1	Steag Power		Ennis (Ellis)	1200	2001	ERCOT
X2	KM Power		(Harris)	1070	2001	ERCOT
X3	Constellation Power	Gateway Power Project	Gilmer (Upshur)	800	2001	SPP
X4	KM Power		Boonville (Wise)	510	2001	ERCOT
X5	BP/Cinergy		Alvin (Brazoria)	70	2001	ERCOT
X6	ANP		Edinburg (Hidalgo)	550	2002	ERCOT
X7	Celanese		Pasadena (Harris)	284	2002	ERCOT
	7 Projects Cancelled		Total Capacity	4,484		

Total Texas Generation by Resource Type (GWh) PUCT Table 9

	Natural Gas/Oil		Coal		Lignite		Nuclear		Hydro		Other		Net Utility Generation		Net Energy Purchases		Total
1994	95,651		60,053		57,206		33,158		1,325		212		247,605		36,074		283,679
1995	96,019	0.4%	60,262	0.3%	57,277	0.1%	42,043	21.1%	1,658		226	6.2%	257,485	3.8%	35,822	-0.7%	293,307
1996	96,860	0.9%	62,402	3.4%	62,669	8.6%	41,528	-1.2%	729		230	1.7%	264,419	2.6%	45,218	20.8%	309,637
1997	96,901	0.0%	64,811	3.7%	61,219	-2.4%	43,154	3.8%	1,701		226	-1.8%	268,010	1.3%	51,628	12.4%	319,639
1998	113,840	14.9%	66,178	2.1%	59,717	-2.5%	44,805	3.7%	1,317		237	4.6%	286,095	6.3%	51,268	-0.7%	337,363
1999	109,340	-4.1%	69,670	5.0%	60,063	0.6%	43,004	-4.2%	1,008		234	-1.3%	283,318	-1.0%	51,841	1.1%	335,159
average=		2.4%		2.9%		0.9%		4.6%				-22.0%		1.9%		2.6%	
Utility Percent by Fuel Type		38.6%		24.6%		21.2%		15.2%				0.4%		0.1%			
Total Percent by Fuel Type		32.6%		20.8%		17.9%		12.8%				0.3%		0.1%			15.5%
2000	99,895	-9.5%	78,617	11.4%	55,772	-7.7%	42,535	-1.1%	1,222		334	29.9%	278,375	-1.8%	59,206	12.4%	337,582
2001	94,424	-5.8%	79,755	1.4%	53,744	-3.8%	42,298	-0.6%	1,222		363	8.0%	271,806	-2.4%	68,337	13.4%	340,142
2002	90,304	-4.6%	80,832	1.3%	52,369	-2.6%	42,410	0.3%	1,222		380	4.5%	267,517	-1.6%	82,613	17.3%	350,129
2003	87,656	-3.0%	82,644	2.2%	51,188	-2.3%	42,135	-0.7%	1,221		370	-2.7%	265,215	-0.9%	92,256	10.5%	357,471
2004	87,123	-0.6%	83,308	0.8%	49,943	-2.5%	42,001	-0.3%	1,222		364	-1.6%	263,961	-0.5%	102,550	10.0%	366,511
2005	86,038	-1.3%	84,485	1.4%	48,775	-2.4%	42,460	1.1%	1,220		375	2.9%	263,353	-0.2%	110,625	7.3%	373,979
2006	85,014	-1.2%	85,325	1.0%	47,925	-1.8%	41,965	-1.2%	1,221		370	-1.4%	261,820	-0.6%	121,663	9.1%	383,482
2007	85,651	0.7%	86,267	1.1%	46,842	-2.3%	41,491	-1.1%	1,219		370	0.0%	261,841	0.0%	129,770	6.2%	391,612
2008	84,899	-0.9%	87,454	1.4%	46,028	-1.8%	42,205	1.7%	1,221		372	0.5%	262,179	0.1%	139,049	6.7%	401,228
2009	81,386	-4.3%	92,507	5.5%	45,088	-2.1%	42,192	0.0%	1,219		371	-0.3%	262,764	0.2%	147,651	5.8%	410,415
average=		-3.0%		2.7%		-2.9%		-0.2%				1.7%		4.0%		-0.8%	9.9%
Utility Percent by Fuel Type		31.0%		35.2%		17.2%		16.1%				0.5%		0.1%			22.45% average
Total Percent by Fuel Type		19.8%		22.5%		11.0%		10.3%				0.3%		0.1%			36.0%
																	2% Annual Generation Increase
																	Population

from 2000 Annual Update of Generating Electric Utility Data, published by the Public Utilities Commission of Texas

Future Generation by Fuel Type

PUCT Generation Projections

	Natural Gas/Oil	Coal & Lignite	Nuclear	Net Energy Purchases	Total	Linear Curve Fit	
2000	99,895	134,389	42,535	59,206	337,582	Coal and Lignite	$160.84x + 133002$ R2 = 0.1286
2001	94,424	133,499	42,298	68,337	340,142	Nuclear	$-50.812x + 42449$ R2 = 0.2579
2002	90,304	133,201	42,410	82,613	350,129	Natural Gas Purchases	$-1609.3x + 97090$ R2 = 0.8217
2003	87,656	133,832	42,135	92,256	357,471		$9836.8x + 51270$ R2 = 0.9965
2004	87,123	133,251	42,001	102,550	366,511	Total	$8339.5x + 325388$ R2 = 0.9954
2005	86,038	133,260	42,460	110,625	373,979		
2006	85,014	133,250	41,965	121,663	383,482		
2007	85,651	133,109	41,491	129,770	391,612		
2008	84,899	133,482	42,205	139,049	401,228		
2009	81,386	137,595	42,192	147,651	410,415		

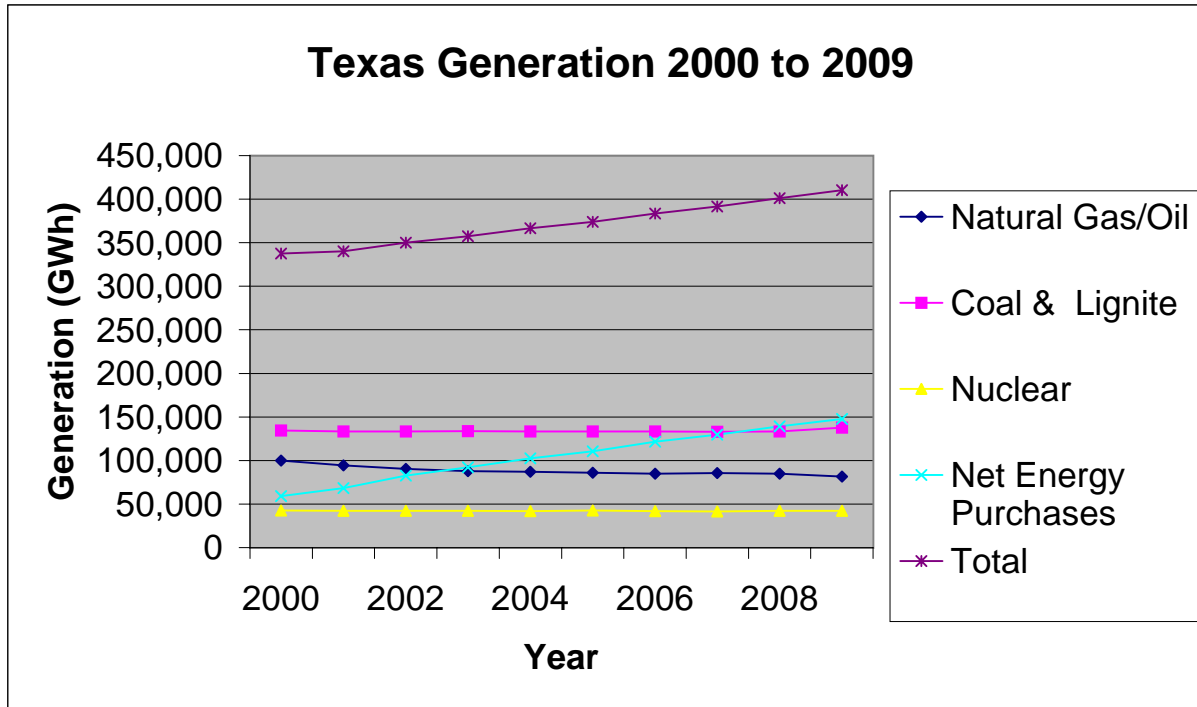

from 2000 Annual Update of Generating Electric Utility Data, published by the Public Utilities Commission of Texas

Projected Power Demand in ERCOT by Fuel Type

Table 60. Electric Power Projections for Electricity Market Module Region Electric Reliability Council of Texas																					
	2000	2001	2002	2003	2004	2005	2006	2007	2008	2009	2010	2011	2012	2013	2014	2015	2016	2017	2018	2019	2020
Electricity Generating Capacity 1/ (gigawatts)																					
Coal Steam	15.25	15.25	15.25	15.25	15.25	15.25	15.25	15.25	15.25	15.25	15.25	15.25	15.25	15.25	15.25	15.25	15.25	15.25	15.25	15.25	15.25
Other Fossil Steam 2/	29.95	29.91	29.83	29.55	29.30	28.77	27.07	24.86	22.95	22.88	22.88	22.79	22.79	22.69	22.53	22.53	22.53	22.53	22.53	22.53	22.31
Combined Cycle	4.01	4.01	3.98	3.98	5.04	5.91	6.74	10.42	13.20	15.28	16.54	17.76	18.07	18.73	19.76	20.47	21.01	21.50	21.96	22.50	23.07
Combustion Turbine/Diesel	3.12	3.12	4.40	4.77	5.13	5.54	8.77	9.67	10.51	10.66	11.22	11.30	11.45	11.74	11.92	12.02	12.09	12.15	12.20	12.31	12.39
Nuclear Power	4.80	4.80	4.82	4.82	4.82	4.82	4.82	4.82	4.82	4.82	4.82	4.82	4.82	4.82	4.82	4.82	4.82	4.82	4.82	4.82	4.82
Pumped Storage/Other 3/	0.00	0.00	0.00	0.00	0.00	0.00	0.00	0.00	0.00	0.00	0.00	0.00	0.00	0.00	0.00	0.00	0.00	0.00	0.00	0.00	0.00
Fuel Cells	0.00	0.00	0.00	0.00	0.00	0.00	0.00	0.00	0.00	0.00	0.00	0.00	0.00	0.00	0.00	0.00	0.00	0.00	0.00	0.00	0.00
Renewable Sources 4/	0.77	2.00	2.16	2.30	2.43	2.57	2.64	2.72	2.79	2.87	2.89	2.91	2.93	2.95	2.97	2.99	3.01	3.04	3.06	3.08	3.10
Distributed Generation 5/	0.00	0.00	0.00	0.06	0.10	0.15	0.23	0.32	0.56	0.79	1.02	1.09	1.16	1.23	1.31	1.42	1.55	1.76	1.96	2.15	2.33
Total Capacity	57.90	59.08	60.43	60.72	62.06	63.00	65.52	68.05	70.06	72.74	74.62	75.91	76.46	77.40	78.72	79.50	80.25	81.04	81.77	82.64	83.25
Cumulative Planned Additions 6/																					
Coal Steam	0.00	0.00	0.00	0.00	0.00	0.00	0.00	0.00	0.00	0.00	0.00	0.00	0.00	0.00	0.00	0.00	0.00	0.00	0.00	0.00	0.00
Other Fossil Steam 2/	0.00	0.00	0.00	0.00	0.00	0.00	0.00	0.00	0.00	0.00	0.00	0.00	0.00	0.00	0.00	0.00	0.00	0.00	0.00	0.00	0.00
Combined Cycle	0.00	0.00	0.00	0.00	0.00	0.00	0.00	0.00	0.00	0.00	0.00	0.00	0.00	0.00	0.00	0.00	0.00	0.00	0.00	0.00	0.00
Combustion Turbine/Diesel	0.00	0.00	0.00	0.00	0.00	0.00	0.00	0.00	0.00	0.00	0.00	0.00	0.00	0.00	0.00	0.00	0.00	0.00	0.00	0.00	0.00
Nuclear Power	0.00	0.00	0.00	0.00	0.00	0.00	0.00	0.00	0.00	0.00	0.00	0.00	0.00	0.00	0.00	0.00	0.00	0.00	0.00	0.00	0.00
Pumped Storage/Other 3/	0.00	0.00	0.00	0.00	0.00	0.00	0.00	0.00	0.00	0.00	0.00	0.00	0.00	0.00	0.00	0.00	0.00	0.00	0.00	0.00	0.00
Fuel Cells	0.00	0.00	0.00	0.00	0.00	0.00	0.00	0.00	0.00	0.00	0.00	0.00	0.00	0.00	0.00	0.00	0.00	0.00	0.00	0.00	0.00
Renewable Sources 4/	0.00	1.22	1.39	1.53	1.66	1.80	1.87	1.95	2.02	2.10	2.12	2.14	2.16	2.18	2.20	2.22	2.24	2.26	2.29	2.31	2.33
Distributed Generation 5/	0.00	0.00	0.00	0.00	0.00	0.00	0.00	0.00	0.00	0.00	0.00	0.00	0.00	0.00	0.00	0.00	0.00	0.00	0.00	0.00	0.00
Total Planned Additions	0.00	1.22	1.39	1.53	1.66	1.80	1.87	1.95	2.02	2.10	2.12	2.14	2.16	2.18	2.20	2.22	2.24	2.26	2.29	2.31	2.33
Cumulative Unplanned Additions 6/																					
Coal Steam	0.00	0.00	0.00	0.00	0.00	0.00	0.00	0.00	0.00	0.00	0.00	0.00	0.00	0.00	0.00	0.00	0.00	0.00	0.00	0.00	0.00
Other Fossil Steam 2/	0.00	0.00	0.00	0.00	0.00	0.00	0.00	0.00	0.00	0.00	0.00	0.00	0.00	0.00	0.00	0.00	0.00	0.00	0.00	0.00	0.00
Combined Cycle	0.00	0.00	0.00	0.00	1.06	1.94	2.77	6.45	9.22	11.31	12.57	13.79	14.09	14.75	15.78	16.50	17.03	17.53	17.99	18.53	19.09
Combustion Turbine/Diesel	0.00	0.00	1.28	2.08	2.43	2.86	6.10	6.99	7.88	8.23	8.60	8.67	8.82	9.11	9.30	9.39	9.46	9.52	9.57	9.69	9.76
Nuclear Power	0.00	0.00	0.00	0.00	0.00	0.00	0.00	0.00	0.00	0.00	0.00	0.00	0.00	0.00	0.00	0.00	0.00	0.00	0.00	0.00	0.00
Pumped Storage/Other 3/	0.00	0.00	0.00	0.00	0.00	0.00	0.00	0.00	0.00	0.00	0.00	0.00	0.00	0.00	0.00	0.00	0.00	0.00	0.00	0.00	0.00
Fuel Cells	0.00	0.00	0.00	0.00	0.00	0.00	0.00	0.00	0.00	0.00	0.00	0.00	0.00	0.00	0.00	0.00	0.00	0.00	0.00	0.00	0.00
Renewable Sources 4/	0.00	0.00	0.00	0.00	0.00	0.00	0.00	0.00	0.00	0.00	0.00	0.00	0.00	0.00	0.00	0.00	0.00	0.00	0.00	0.00	0.00
Total Unplanned Additions	0.00	0.00	1.28	2.14	3.59	4.94	9.10	13.76	17.66	20.33	22.18	23.55	24.07	25.10	26.39	27.31	28.04	28.81	29.52	30.37	31.18
Distributed Generation 5/	0.00	0.00	0.00	0.06	0.10	0.15	0.23	0.32	0.56	0.79	1.02	1.09	1.16	1.23	1.31	1.42	1.55	1.76	1.96	2.15	2.33
Cumulative Total Additions	0.00	1.22	2.67	3.67	5.26	6.74	10.97	15.70	19.68	22.43	24.30	25.69	26.23	27.28	28.60	29.53	30.29	31.07	31.80	32.67	33.51
Cumulative Retirements 7/																					
Coal Steam	0.00	0.00	0.00	0.00	0.00	0.00	0.00	0.00	0.00	0.00	0.00	0.00	0.00	0.00	0.00	0.00	0.00	0.00	0.00	0.00	0.00
Other Fossil Steam 3/	0.00	0.00	0.07	0.35	0.60	1.13	2.84	5.05	6.96	7.02	7.02	7.12	7.12	7.22	7.22	7.38	7.38	7.38	7.38	7.38	7.80
Combined Cycle	0.00	0.00	0.04	0.04	0.04	0.04	0.04	0.04	0.04	0.04	0.04	0.04	0.04	0.04	0.04	0.04	0.04	0.04	0.04	0.04	0.04
Combustion Turbine/Diesel	0.00	0.00	0.00	0.43	0.43	0.44	0.44	0.44	0.49	0.49	0.49	0.49	0.49	0.49	0.49	0.49	0.49	0.49	0.49	0.49	0.49
Nuclear Power	0.00	0.00	0.00	0.00	0.00	0.00	0.00	0.00	0.00	0.00	0.00	0.00	0.00	0.00	0.00	0.00	0.00	0.00	0.00	0.00	0.00
Pumped Storage	0.00	0.00	0.00	0.00	0.00	0.00	0.00	0.00	0.00	0.00	0.00	0.00	0.00	0.00	0.00	0.00	0.00	0.00	0.00	0.00	0.00
Fuel Cells	0.00	0.00	0.00	0.00	0.00	0.00	0.00	0.00	0.00	0.00	0.00	0.00	0.00	0.00	0.00	0.00	0.00	0.00	0.00	0.00	0.00
Renewable Sources 4/	0.00	0.00	0.00	0.00	0.00	0.00	0.00	0.00	0.00	0.00	0.00	0.00	0.00	0.00	0.00	0.00	0.00	0.00	0.00	0.00	0.00
Total	0.00	0.00	0.11	0.82	1.07	1.61	3.32	5.53	7.49	7.55	7.55	7.64	7.64	7.74	7.74	7.90	7.90	7.90	7.90	7.90	8.12
Cogenerators 8/																					
Capability																					
Coal	0.28	0.28	0.28	0.28	0.28	0.28	0.28	0.28	0.28	0.28	0.28	0.28	0.28	0.28	0.28	0.28	0.28	0.28	0.28	0.28	0.28
Petroleum	0.35	0.35	0.35	0.35	0.35	0.35	0.34	0.34	0.34	0.34	0.34	0.34	0.34	0.34	0.34	0.34	0.34	0.34	0.34	0.34	0.34
Natural Gas	9.33	9.59	9.66	9.84	10.09	10.32	10.55	10.75	10.95	11.16	11.38	11.62	11.85	12.08	12.32	12.58	12.86	13.12	13.42	13.71	14.04
Other Gaseous Fuels	0.10	0.10	0.10	0.16	0.16	0.16	0.16	0.16	0.17	0.17	0.18	0.18	0.19	0.19	0.20	0.20	0.20	0.21	0.22	0.22	0.23
Renewable Sources 4/	0.00	0.00	0.00	0.00	0.00	0.00	0.00	0.00	0.00	0.00	0.00	0.00	0.00	0.00	0.00	0.00	0.00	0.00	0.00	0.00	0.00
Other	0.00	0.00	0.00	0.00	0.00	0.00	0.00	0.00	0.00	0.00	0.00	0.00	0.00	0.00	0.00	0.00	0.00	0.00	0.00	0.00	0.00
Total	10.06	10.32	10.39	10.62	10.87	11.10	11.34	11.54	11.74	11.95	12.18	12.42	12.66	12.90	13.14	13.41	13.68	13.95	14.25	14.56	14.89
Electricity Demand (billion kilowatthours)																					
Residential	100.55	103.06	105.51	109.15	111.36	113.36	114.90	116.17	117.64	119.42	121.43	123.49	125.45	127.46	129.63	131.96	134.04	136.24	138.47	140.85	143.15
Commercial/Other	83.57	83.45	85.11	88.14	90.88	93.18	95.56	98.09	100.65	103.33	106.07	108.74	111.03	113.09	115.00	116.63					

Projected Power Demand in ERCOT by Fuel Type

Table 60 Electric Power Projections for Electricity Market Module Region Electric Reliability Council of Texas																					
	2000	2001	2002	2003	2004	2005	2006	2007	2008	2009	2010	2011	2012	2013	2014	2015	2016	2017	2018	2019	2020
Industrial	83.98	80.17	80.86	84.23	86.43	88.61	90.97	94.14	95.19	96.90	99.65	102.34	103.98	105.42	107.01	108.51	109.78	111.08	112.51	113.90	115.17
Transportation	0.98	1.01	1.04	1.17	1.30	1.42	1.53	1.63	1.73	1.83	1.93	2.03	2.13	2.23	2.33	2.38	2.37	2.36	2.34	2.31	2.28
Total Sales	269.07	267.68	272.52	282.69	289.97	296.56	302.96	310.03	315.20	321.48	329.09	336.61	342.59	348.20	353.97	359.47	364.19	368.92	373.60	378.43	383.01
Net Energy for Load (billion kilowatt-hours) 7/																					
Gross International Imports	0.00	0.00	0.00	0.00	0.00	0.00	0.00	0.00	0.00	0.00	0.00	0.00	0.00	0.00	0.00	0.00	0.00	0.00	0.00	0.00	0.00
Gross International Exports	0.30	0.33	0.36	0.39	0.42	0.45	0.49	0.53	0.57	0.62	0.67	0.67	0.67	0.67	0.67	0.67	0.67	0.67	0.67	0.67	0.67
Gross Interregional Electricity Imports	3.63	3.48	2.64	2.93	3.02	3.16	3.49	3.66	3.05	3.07	2.93	2.66	2.63	2.55	2.38	2.06	1.87	1.98	1.83	1.70	1.76
Gross Interregional Electricity Exports	2.87	3.13	3.11	2.52	2.27	2.05	2.26	2.09	2.25	2.63	2.55	2.61	2.44	2.74	2.64	2.68	2.50	2.19	1.46	1.21	1.00
Purchases from Cogenerators 8/	30.60	31.27	31.30	31.93	32.29	32.65	32.55	32.54	32.63	32.99	33.51	34.04	34.65	35.22	35.87	36.60	37.35	38.05	38.88	39.73	40.64
Utility Generation for Customers	255.23	253.35	259.08	268.22	274.96	281.02	287.64	294.54	300.58	306.99	314.60	322.05	327.56	333.10	338.35	343.57	347.80	351.67	355.19	359.30	362.94
Total Net Energy for Load	286.28	284.65	289.56	300.17	307.58	314.34	320.93	328.12	333.45	339.81	347.81	355.48	361.74	367.46	373.29	378.87	383.85	388.84	393.76	398.84	403.67
Generation by Fuel Type (billion kWh)																					
Coal	110.88	109.82	107.95	109.61	111.04	111.79	112.52	113.23	113.23	112.92	112.73	112.74	112.74	112.93	113.23	112.83	113.22	113.23	113.23	113.25	113.23
Petroleum	0.29	2.91	0.22	0.13	0.12	0.12	0.10	0.08	0.07	0.04	0.05	0.05	0.05	0.07	0.05	0.04	0.06	0.05	0.06	0.07	0.06
Natural Gas	104.74	99.17	106.06	114.85	119.72	124.58	130.11	136.00	141.67	147.54	155.03	162.32	167.66	172.82	178.11	183.06	187.18	190.82	194.11	197.98	201.43
Nuclear	39.10	39.48	40.84	39.17	39.17	39.17	39.17	39.17	39.17	39.17	39.17	39.17	39.17	39.17	39.17	39.17	39.17	39.17	39.17	39.17	39.17
Pumped Storage/Other 3/	0.00	0.00	0.00	0.00	0.00	0.00	0.00	0.00	0.00	0.00	0.00	0.00	0.00	0.00	0.00	0.00	0.00	0.00	0.00	0.00	0.00
Renewable Sources 4/	1.30	3.68	5.52	5.95	6.38	6.81	7.15	7.43	7.71	8.48	8.88	8.81	8.95	9.08	9.36	9.36	8.99	9.13	9.26	9.40	9.53
Total Generation	256.31	254.86	260.59	269.73	276.47	282.54	289.15	296.05	302.08	308.51	316.11	323.56	329.07	334.61	339.87	345.08	349.31	353.18	356.70	360.81	364.45
Sales to Customers	255.23	253.35	259.08	268.22	274.96	281.02	287.64	294.54	300.58	306.99	314.60	322.05	327.56	333.10	338.35	343.57	347.80	351.67	355.19	359.30	362.94
Generation for Own Use	1.08	1.51	1.51	1.51	1.51	1.51	1.51	1.51	1.51	1.51	1.51	1.51	1.51	1.51	1.51	1.51	1.51	1.51	1.51	1.51	1.51
Cogenerators																					
Coal	2.86	2.86	2.86	2.84	2.83	2.83	2.82	2.81	2.79	2.78	2.78	2.77	2.77	2.76	2.76	2.75	2.75	2.74	2.74	2.73	2.73
Petroleum	0.20	0.20	0.20	0.22	0.22	0.22	0.22	0.22	0.22	0.22	0.22	0.23	0.23	0.23	0.23	0.23	0.23	0.24	0.24	0.24	0.24
Natural Gas	56.35	59.02	59.32	62.09	63.98	65.72	66.96	68.06	69.23	70.69	72.41	74.17	75.97	77.72	79.53	81.58	83.73	85.77	88.02	90.30	92.85
Other Gaseous Fuels	0.16	0.16	0.16	0.24	0.24	0.24	0.25	0.25	0.25	0.26	0.27	0.27	0.28	0.29	0.29	0.30	0.30	0.31	0.32	0.33	0.34
Renewable Sources 4/	0.18	0.18	0.18	0.19	0.19	0.20	0.21	0.22	0.22	0.23	0.23	0.24	0.25	0.25	0.26	0.27	0.27	0.28	0.28	0.29	0.29
Other	0.63	0.64	0.64	0.64	0.64	0.64	0.64	0.64	0.64	0.64	0.64	0.64	0.64	0.64	0.64	0.64	0.64	0.64	0.64	0.64	0.64
Total	60.38	63.06	63.36	66.22	68.11	69.86	71.10	72.20	73.36	74.82	76.55	78.33	80.14	81.90	83.72	85.77	87.93	89.98	92.24	94.54	97.10
Sales to Utilities	30.60	31.27	31.30	31.93	32.29	32.65	32.55	32.54	32.63	32.99	33.51	34.04	34.65	35.22	35.87	36.60	37.35	38.05	38.88	39.73	40.64
Generation for Own Use	29.78	31.79	32.06	34.29	35.82	37.21	38.55	39.66	40.72	41.83	43.04	44.29	45.49	46.68	47.85	49.17	50.58	51.93	53.37	54.81	56.46
End-Use Prices (2000 cents per kilowatt-hour)																					
Residential	7.9	7.7	7.1	7.0	7.1	7.1	6.8	7.0	6.9	6.7	6.6	6.6	6.7	6.7	6.7	6.8	6.9	7.0	7.1	7.1	7.3
Commercial	7.0	7.2	6.7	6.5	6.6	6.8	6.5	6.3	6.1	5.8	5.7	5.6	5.7	5.8	5.8	5.9	5.9	6.1	6.2	6.3	6.5
Industrial	4.1	4.3	4.1	4.0	4.2	4.4	4.3	4.1	4.0	3.9	3.9	3.9	4.0	4.1	4.1	4.1	4.2	4.3	4.4	4.5	4.6
Transportation	6.2	6.5	6.1	5.5	5.4	5.4	5.3	5.2	5.2	5.2	5.3	5.4	5.5	5.6	5.6	5.6	5.6	5.6	5.7	5.7	5.7
All Sectors Average	6.4	6.5	6.1	6.0	6.1	6.2	6.0	5.9	5.8	5.6	5.5	5.5	5.6	5.6	5.6	5.7	5.8	5.8	6.0	6.1	6.2
Prices by Service Category (2000 cents/kilowatt-hour)																					
Generation	4.5	4.7	4.3	4.1	4.2	4.4	4.1	4.0	3.9	3.6	3.6	3.5	3.7	3.7	3.7	3.8	3.9	4.0	4.1	4.2	4.4
Transmission	0.5	0.4	0.4	0.4	0.5	0.5	0.5	0.5	0.5	0.6	0.6	0.6	0.6	0.5	0.5	0.5	0.5	0.5	0.5	0.5	0.5
Distribution	1.4	1.4	1.4	1.4	1.4	1.4	1.3	1.3	1.4	1.4	1.4	1.4	1.3	1.3	1.3	1.3	1.4	1.4	1.3	1.3	1.3
Fuel Consumption (quadrillion Btu) 9/																					
Coal	1.17	1.16	1.14	1.15	1.17	1.18	1.19	1.19	1.19	1.19	1.19	1.19	1.19	1.19	1.19	1.19	1.19	1.19	1.19	1.19	1.19
Natural Gas	1.05	0.96	1.04	1.13	1.15	1.18	1.22	1.19	1.19	1.20	1.25	1.29	1.33	1.37	1.39	1.43	1.45	1.48	1.50	1.52	1.54
Oil	0.00	0.03	0.00	0.00	0.00	0.00	0.00	0.00	0.00	0.00	0.00	0.00	0.00	0.00	0.00	0.00	0.00	0.00	0.00	0.00	0.00
Total	2.22	2.15	2.18	2.28	2.32	2.36	2.40	2.39	2.38	2.39	2.43	2.48	2.52	2.56	2.59	2.61	2.65	2.67	2.69	2.72	2.74
Emissions (million tons) 10/																					
Total Carbon	50.40	49.14	49.16	50.98	51.76	52.45	53.25	53.10	53.03	53.15	53.85	54.55	55.20	55.78	56.29	56.67	57.24	57.64	58.01	58.42	58.75
Carbon Dioxide	184.80	180.17	180.25	186.93	189.79	192.31	195.24	194.71	194.45	194.88	197.45	200.02	202.40	204.52	206.41	207.80	209.90	211.35	212.69	214.21	215.43
Sulfur Dioxide	0.35	0.40	0.38	0.35	0.35	0.38	0.42	0.40	0.39	0.38	0.38	0.30	0.30	0.30	0.31	0.31	0.30	0.33	0.33	0.36	0.36
Nitrogen Oxide	0.27	0.27	0.27	0.28	0.28	0.27	0.27	0.26	0.24	0.24	0.24	0.24	0.24	0.24	0.24	0.24	0.24	0.24	0.24	0.24	0.24

from US DOE Energy Information Administration's 2000 Annual Energy Outlook

Projected Power Demand in ERCOT by Fuel Type

Table 60. Electric Power Projections for Electricity Market Module Region Electric Reliability Council of Texas		2000	2001	2002	2003	2004	2005	2006	2007	2008	2009	2010	2011	2012	2013	2014	2015	2016	2017	2018	2019	2020
<p>1/ Net summer capability is the steady hourly output that generating equipment is expected to supply to system load (exclusive of auxiliary power), as demonstrated by tests during summer peak demand. Includes electric utilities, small power producers, and exempt wholesale generators. Nameplate capacity is reported for nonutilities on Form EIA-860B, "Annual Electric Generator Report - Nonutility." Nameplate capacity is designated by the manufacturer. The nameplate capacity has been converted to net summer capacity based on historic relationships.</p> <p>2/ Includes oil-, gas-, and dual-fired capability.</p> <p>3/ Other includes methane, propane gas, and blast furnace gas for utilities; and hydrogen, sulfur, batteries, chemicals, fish oil, and spent sulfite liquor.</p> <p>4/ Includes conventional hydroelectric, geothermal, wood, wood waste, municipal solid waste, other biomass, solar thermal, photovoltaics, and wind power.</p> <p>5/ Primarily peak-load capacity fueled by natural gas.</p> <p>6/ Cumulative additions after December 31, 2000.</p> <p>7/ Generation to meet system load by source.</p> <p>8/ Cogenerators produce electricity and other useful thermal energy (such as steam or heat) through the sequential use of energy.</p> <p>9/ Includes fuel consumption by electric utilities, small power producers, independent power producers, and exempt wholesale generators.</p> <p>10/ Estimated emissions from utilities and nonutilities (excluding cogenerators).</p> <p>O&M = Operation and maintenance EMM = Electricity market module N/A = Not applicable.</p> <p>Note: Totals may not equal sum of components due to independent rounding.</p> <p>Sources: 2000 (except for prices and nonutility data): Energy Information Administration (EIA), Annual Energy Review 2000, DOE/EIA-0384(2000) (Washington, DC, August 2001). Other 2000 and projections: NewGen Data and Analysis, RDI Consulting/FT Energy (Boulder, CO, February 2001) and EIA, AEO2002 National Energy Modeling System run aeo2002.d102001b.</p>																						

Appendix F

Comparison of previous projections for future water use by electric generation

A reviewed the 1997 and 2002 water use projections, focusing on areas where changed conditions or new information might justify revisions to the projections. Below is information regarding the previous methodology for making the projections taken from the 1997 and 2002 referenced reports.

1997 State Water Plan

“Water used for steam electric power generation totaled about 426,000 acre-feet in 1990. This represents an increase in water use of nearly 122,000 ac-feet of water above the 1980 level of water use. Currently, water used for steam-electric power generation accounts for about 3 % of the state’s total water use. Based on the recommended case projection scenario, state wide water use for steam electric power generation is projected to increase from 426,000 acre feet in 1990 to about 938,000 acre feet by the year 2050...” (Reference: “Water for Texas August 1997, page 3-8)

“Water use projections for steam electric power generation have two major components: power generation capacity and water use for that projected capacity. Power generation projections were based on current per capita electric demand for reported residential, commercial, and other sectors on a utility specific basis. Industrial [electrical] power water uses were based on each utility’s reported sales by Standard Industrial Classification (SIC). A composite growth factor was estimated for the remaining unaccounted-for sales. For existing plants, future water use was assumed to remain constant at the average 1988 – 1991 historical water use patterns unless information indicated that plants were scheduled for closure. For planned plants and facilities, water use permits and/or plant design data were used to determine future water needs. If permit or facility design information was not available, it was assumed that additional generation would use water at the same gallons per kilowatt-hour rate as the current average use for that utility.” (Reference: “Water for Texas August 1997”, page 2-19)

In developing the steam electric water use projections, a number of assumptions were used including: (1) power generation demands will grow in direct proportion to population growth for residential, commercial, and other sectors. The power demands are based on the recommended-case population projections: (2) industrial power generation demands are assumed to grow in direct proportion to industrial and manufacturing growth projections for each major electric power use by SIC (3) no change is assumed in electric power generation capacity for the upper case scenario; and (4) a combination of technological, conservation measures and other factors are assumed to reduce total water use by five percent by the year 2000, ten percent by 2010, and 15 percent from 2020 to 2050. (Reference: “Water for Texas August 1997”, page 2-19)

Two scenarios were developed to reflect potential technology changes in the electric power industry...the advanced combined-cycle combustion technology, if broadly implemented by the power industry, could significantly lower water use in this sector. (Reference: "Water for Texas August 1997", page 2-20)

A number of data sources were used in the development of steam electric power water use projections. These sources included TWDB's survey of annual water use (1980-1991); the consensus population and water use projections developed by staffs of the three agencies with advisory committee assistance; PUCT's projections of additions and removal of power generation to the year 2005; fuel use, thermodynamics of existing power plants, co-generation statistics, long range power needs, and the impact of technology on power generation; water rights permit information from TNRCC; and research on new technologies and related information from the Electric Power Research Institute. (Reference: "Water for Texas August 1997", page 2-20)

Because it is unknown where future power plants will be located, the methodology assumes that power generation will occur in locations that have historically had power generation or where power companies have announced new locations. However, unforeseen technological advances, changes in market forces, and conservation efforts could affect both power plant locations and water use. Additionally, changes in Federal regulations could have an important affect on steam electric power generation and water use. (Reference: "Water for Texas August 1997", page 2-20)

2002 Water Use Plan

"In determining current and future water use of steam electric power generation, the TWDB relied on several types of information. Current water use for the base year 1990 was obtained for each plant from the TWDB's water use survey. Demands for many new plants, both completed and under construction, were identified by Planning Groups as part of the regional planning process. Future water demand was estimated using a combination of available information, including published materials on planned additions to existing plants, existing water rights permits, specific company information, lignite-resource ownership, and other related sources. Individual plant design, thermodynamic operating characteristics, energy- conservation strategies, and technological improvements were also evaluated to determine how water use would change over time." (Reference: "Water for Texas 2002, page 36)

Appendix G

Glossary of Electricity Terms

Anthracite: The highest rank of coal; used primarily for residential and commercial space heating. It is hard, brittle, and black lustrous coal, often referred to as hard coal, containing a high percentage of fixed carbon and a low percentage of volatile matter. The moisture content of fresh-mined anthracite generally is less than 15 percent. The heat content of anthracite ranges from 22 to 28 million Btu per ton on a moist, mineral-matter-free basis. The heat content of anthracite coal consumed in the United States averages 25 million Btu per ton, on the as-received basis (i.e., containing both inherent moisture and mineral matter). Note: Since the 1980's, anthracite refuse or mine waste has been used for steam electric power generation. This fuel typically has a heat content of 15 million Btu per ton or less.

Ash: Impurities consisting of silica, iron, alumina, and other noncombustible matter that are contained in coal. Ash increases the weight of coal, adds to the cost of handling, and can affect its burning characteristics. Ash content is measured as a percent by weight of coal on a "received" or a "dry" (moisture-free, usually part of a laboratory analysis) basis.

Baseload Plant: A plant, usually housing high-efficiency steam-electric units, which is normally operated to take all or part of the minimum load of a system, and which consequently produces electricity at an essentially constant rate and runs continuously. These units are operated to maximize system mechanical and thermal efficiency and minimize system operating costs.

Bcf: The abbreviation for 1 billion cubic feet.

Bituminous Coal: A dense coal, usually black, sometimes dark brown, often with well-defined bands of bright and dull material, used primarily as fuel in steam-electric power generation, with substantial quantities also used for heat and power applications in manufacturing and to make coke. Bituminous coal is the most abundant coal in active U.S. mining regions. Its moisture content usually is less than 20 percent. The heat content of bituminous coal ranges from 21 to 30 million Btu per ton on a moist, mineral-matter-free basis. The heat content of bituminous coal consumed in the United States averages 24 million Btu per ton, on the as-received basis (i.e., containing both inherent moisture and mineral matter).

Boiler: A device for generating steam for power, processing, or heating purposes or for producing hot water for heating purposes or hot water supply. Heat from an external combustion source is transmitted to a fluid contained within the tubes in the boiler shell. This fluid is delivered to an end-use at a desired pressure, temperature, and quality.

Capability: The maximum load that a generating unit, generating station, or other electrical apparatus can carry under specified conditions for a given period of time without exceeding approved limits of temperature and stress.

Capacity: The amount of electric power delivered or required for which a generator, turbine, transformer, transmission circuit, station, or system is rated by the manufacturer.

Coal: A readily combustible black or brownish-black rock whose composition, including inherent moisture, consists of more than 50 percent by weight and more than 70 percent by volume of carbonaceous material. It is formed from plant remains that have been compacted, hardened, chemically altered, and metamorphosed by heat and pressure over geologic time.

Cogenerator: A generating facility that produces electricity and another form of useful thermal energy (such as heat or steam), used for industrial, commercial, heating, or cooling purposes. To receive status as a qualifying facility (QF) under the Public Utility Regulatory Policies Act (PURPA), the facility must produce electric energy and "another form of useful thermal energy through the sequential use of energy," and meet certain ownership, operating, and efficiency criteria established by the Federal Energy Regulatory Commission (FERC). (See the Code of Federal Regulations, Title 18, Part 292.)

Coke (Petroleum): A residue high in carbon content and low in hydrogen that is the final product of thermal decomposition in the condensation process in cracking. This product is reported as marketable coke or catalyst coke. The conversion is 5 barrels (of 42 U.S. gallons each) per short ton. Coke from petroleum has a heating value of 6.024 million Btu per barrel.

Combined Cycle: An electric generating technology in which electricity is produced from otherwise lost waste heat exiting from one or more gas (combustion) turbines. The exiting heat is routed to a conventional boiler or to a heat recovery steam generator for utilization by a steam turbine in the production of electricity. This process increases the efficiency of the electric generating unit.

Combined Cycle Unit: An electric generating unit that consists of one or more combustion turbines and one or more boilers with a portion of the required energy input to the boiler(s) provided by the exhaust gas of the combustion turbine(s).

Combined Pumped-Storage Plant: A pumped-storage hydroelectric power plant that uses both pumped water and natural streamflow to produce electricity.

Commercial: The commercial sector is generally defined as non-manufacturing business establishments, including hotels, motels, restaurants, wholesale businesses, retail stores, and health, social, and educational institutions. The utility may classify commercial service as all consumers whose demand or annual use exceeds some specified limit. The limit may be set by the utility based on the rate schedule of the utility.

Consumption (Fuel): The amount of fuel used for gross generation, providing standby service, start-up and/or flame stabilization.

Cooperative Electric Utility: An electric utility legally established to be owned by and operated for the benefit of those using its service. The utility company will generate, transmit, and/or distribute supplies of electric energy to a specified area not being serviced by another utility. Such ventures are generally exempt from Federal income tax laws. Most electric cooperatives were initially financed by the Rural Electrification Administration, U.S. Department of Agriculture.

Current (Electric): A flow of electrons in an electrical conductor. The strength or rate of movement of the electricity is measured in amperes.

Deregulation: The elimination of regulation from a previously regulated industry or sector of an industry.

Distillate Fuel Oil: A general classification for one of the petroleum fractions produced in conventional distillation operations. It is used primarily for space heating, on-and-off-highway diesel engine fuel (including railroad engine fuel and fuel for agriculture machinery), and electric power generation. Included are Fuel Oils No. 1, No. 2, and No. 4; and Diesel Fuels No. 1, No. 2, and No. 4.

Distribution: The delivery of electricity to retail customers (including homes, businesses, etc.).

Electric Plant (Physical): A facility containing prime movers, electric generators, and auxiliary equipment for converting mechanical, chemical, and/or fission energy into electric energy.

Electric Utility: A corporation, person, agency, authority, or other legal entity or instrumentality that owns and/or operates facilities within the United States, its territories, or Puerto Rico for the generation, transmission, distribution, or sale of electric energy primarily for use by the public and files forms listed in the Code of Federal Regulations, Title 18, Part 141. Facilities that qualify as cogenerators or small power producers under the Public Utility Regulatory Policies Act (PURPA) are not considered electric utilities.

Energy: The capacity for doing work as measured by the capability of doing work (potential energy) or the conversion of this capability to motion (kinetic energy). Energy has several forms, some of which are easily convertible and can be changed to another form useful for work. Most of the world's convertible energy comes from fossil fuels that are burned to produce heat that is then used as a transfer medium to mechanical or other means in order to accomplish tasks. Electrical energy is usually measured in kilowatt-hours (kWh), while heat energy is usually measured in British thermal units.

Energy Source: The primary source that provides the power that is converted to electricity through chemical, mechanical, or other means. Energy sources include coal, petroleum and petroleum products, gas, water, uranium, wind, sunlight, geothermal, and other sources.

Facility: An existing or planned location or site at which prime movers, electric generators, and/or equipment for converting mechanical, chemical, and/or nuclear energy into electric energy are situated, or will be situated. A facility may contain more than one generator of either the same or different prime mover type. For a cogenerator, the facility includes the industrial or commercial process.

Federal Energy Regulatory Commission (FERC): A quasi-independent regulatory agency within the Department of Energy having jurisdiction over interstate electricity sales, wholesale electric rates, hydroelectric licensing, natural gas pricing, oil pipeline rates, and gas pipeline certification.

Federal Power Act: Enacted in 1920, and amended in 1935, the Act consists of three parts. The first part incorporated the Federal Water Power Act administered by the former Federal Power Commission, whose activities were confined almost entirely to licensing non-Federal hydroelectric projects. Parts II and III were added with the passage of the Public Utility Act. These parts extended the Act's jurisdiction to include regulating the interstate transmission of electrical energy and rates for its sale as wholesale in interstate commerce. The Federal Energy Regulatory Commission is now charged with the administration of this law.

Federal Power Commission: The predecessor agency of the Federal Energy Regulatory Commission. The Federal Power Commission (FPC) was created by an Act of Congress under the Federal Water Power Act on June 10, 1920. It was charged originally with regulating the electric power and natural gas industries. The FPC was abolished on September 20, 1977, when the Department of Energy was created. The functions of the FPC were divided between the Department of Energy and the Federal Energy Regulatory Commission.

Flue Gas Desulfurization Unit (Scrubber): Equipment used to remove sulfur oxides from the combustion gases of a boiler plant before discharge to the atmosphere. Chemicals, such as lime, are used as the scrubbing media.

Flue Gas Particulate Collectors: Equipment used to remove fly ash from the combustion gases of a boiler plant before discharge to the atmosphere. Particulate collectors include electrostatic precipitators, mechanical collectors (cyclones), fabric filters (baghouses), and wet scrubbers.

Fly Ash: Particulate matter from coal ash in which the particle diameter is less than 1×10^{-4} meter. This is removed from the flue gas using flue gas particulate collectors such as fabric filters and electrostatic precipitators.

Fossil Fuel: Any naturally occurring organic fuel, such as petroleum, coal, and natural gas.

Fossil-Fuel Plant: A plant using coal, petroleum, or gas as its source of energy.

Fuel: Any substance that can be burned to produce heat; also, materials that can be fissioned in a chain reaction to produce heat.

Gas: A fuel burned under boilers and by internal combustion engines for electric generation. These include natural, manufactured and waste gas.

Gas Turbine Plant: A plant in which the prime mover is a gas turbine. A gas turbine consists typically of an axial-flow air compressor, one or more combustion chambers, where liquid or gaseous fuel is burned and the hot gases are passed to the turbine and where the hot gases expand to drive the generator and are then used to run the compressor.

Generating Unit: Any combination of physically connected generator(s), reactor(s), boiler(s), combustion turbine(s), or other prime mover(s) operated together to produce electric power.

Generation (Electricity): The process of producing electric energy by transforming other forms of energy; also, the amount of electric energy produced, expressed in watthours (Wh).

Generation Company: A regulated or non-regulated entity (depending upon the industry structure) that operates and maintains existing generating plants. The generation company may own the generation plants or interact with the short-term market on behalf of plant owners. In the context of restructuring the market for electricity, the generation company is sometimes used to describe a specialized "marketer" for the generating plants formerly owned by a vertically integrated utility.

Gross Generation: The total amount of electric energy produced by the generating units at a generating station or stations, measured at the generator terminals.

Net Generation: Gross generation less the electric energy consumed at the generating station for station use.

Generator: A machine that converts mechanical (kinetic) energy into electrical energy.

Generator Nameplate Capacity: The full-load continuous rating of a generator, prime mover, or other electric power production equipment under specific conditions as designated by the manufacturer. Installed generator nameplate rating is usually indicated on a nameplate physically attached to the generator.

Geothermal Plant: A plant in which the prime mover is a steam turbine. The turbine is driven either by steam produced from hot water or by natural steam that derives its energy from heat found in rocks or fluids at various depths beneath the surface of the earth. The energy is extracted by drilling and/or pumping.

Gigawatt (GW): One billion watts.

Gigawatthour (GWh): One billion watthours.

Gross Generation: The total amount of electric energy produced by a generating facility, as measured at the generator terminals.

Heavy Oil: The fuel oils remaining after the lighter oils have been distilled off during the refining process. Except for start-up and flame stabilization, virtually all petroleum used in steam plants is heavy oil.

Hydroelectric Plant: A plant in which the turbine generators are driven by falling water.

Independent Power Producers: Entities that are also considered nonutility power producers in the United States. These facilities are wholesale electricity producers that operate within the franchised service territories of host utilities and are usually authorized to sell at market-based rates. Unlike traditional electric utilities, Independent Power Producers do not possess transmission facilities or sell electricity in the retail market.

Industrial: The industrial sector is generally defined as manufacturing, construction, mining agriculture, fishing and forestry establishments Standard Industrial Classification (SIC) codes 01-39. The utility may classify industrial service using the SIC codes, or based on demand or annual usage exceeding some specified limit. The limit may be set by the utility based on the rate schedule of the utility.

Intermediate Load (Electric System): The range from base load to a point between base load and peak. This point may be the midpoint, a percent of the peakload, or the load over a specified time period.

Internal Combustion Plant: A plant in which the prime mover is an internal combustion engine. An internal combustion engine has one or more cylinders in which the process of combustion takes place, converting energy released from the rapid burning of a fuel-air mixture into mechanical energy. Diesel or gas-fired engines are the principal types used in electric plants. The plant is usually operated during periods of high demand for electricity.

Investor-Owned Utility: A class of utility whose stock is publicly traded and which is organized as a tax-paying business, usually financed by the sale of securities in the capital market. It is regulated and authorized to achieve an allowed rate of return.

Kilowatt (kW): One thousand watts.

Kilowatthour (kWh): One thousand watthours.

Light Oil: Lighter fuel oils distilled off during the refining process. Virtually all petroleum used in internal combustion and gas-turbine engines is light oil.

Lignite: The lowest rank of coal, often referred to as brown coal, used almost exclusively as fuel for steam-electric power generation. It is brownish-black and has a high inherent moisture content, sometimes as high as 45 percent. The heat content of lignite ranges from 9 to 17 million Btu per ton on a moist, mineral-matter-free basis. The heat content of lignite consumed in the United States averages 13 million Btu per ton, on the as-received basis (i.e., containing both inherent moisture and mineral matter).

Load (Electric): The amount of electric power delivered or required at any specific point or points on a system. The requirement originates at the energy-consuming equipment of the consumers.

Mcf: One thousand cubic feet.

Megawatt (MW): One million watts.

Megawatthour (MWh): One million watthours.

MMcf: One million cubic feet.

Natural Gas: A naturally occurring mixture of hydrocarbon and nonhydrocarbon gases found in porous geological formations beneath the earth's surface, often in association with petroleum. The principal constituent is methane.

Net Generation: Gross generation minus plant use from all electric utility owned plants. The energy required for pumping at a pumped-storage plant is regarded as plant use and must be deducted from the gross generation.

Net Summer Capability: The steady hourly output, which generating equipment is expected to supply to system load exclusive of auxiliary power, as demonstrated by tests at the time of summer peak demand.

Net Winter Capability: The steady hourly output which generating equipment is expected to supply to system load exclusive of auxiliary power, as demonstrated by tests at the time of winter peak demand.

Nonutility Power Producer: A corporation, person, agency, authority, or other legal entity or instrumentality that owns electric generating capacity and is not an electric utility. Nonutility power producers include qualifying cogenerators, qualifying small power producers, and other nonutility generators (including independent power

producers) without a designated franchised service area, and which do not file forms listed in the Code of Federal Regulations, Title 18, Part 141.

Nuclear Fuel: Fissionable materials that have been enriched to such a composition that, when placed in a nuclear reactor, will support a self-sustaining fission chain reaction, producing heat in a controlled manner for process use.

Nuclear Power Plant: A facility in which heat produced in a reactor by the fissioning of nuclear fuel is used to drive a steam turbine.

Peak Demand: The maximum load during a specified period of time.

Peak Load Plant: A plant usually housing old, low-efficiency steam units; gas turbines; diesels; or pumped-storage hydroelectric equipment normally used during the peak-load periods.

Peaking Capacity: Capacity of generating equipment normally reserved for operation during the hours of highest daily, weekly, or seasonal loads. Some generating equipment may be operated at certain times as peaking capacity and at other times to serve loads on an around-the-clock basis.

Petroleum: A mixture of hydrocarbons existing in the liquid state found in natural underground reservoirs, often associated with gas. Petroleum includes fuel oil No. 2, No. 4, No. 5, No. 6; topped crude; Kerosene; and jet fuel.

Petroleum (Crude Oil): A naturally occurring, oily, flammable liquid composed principally of hydrocarbons. Crude oil is occasionally found in springs or pools but usually is drilled from wells beneath the earth's surface.

Plant: A facility at which are located prime movers, electric generators, and auxiliary equipment for converting mechanical, chemical, and/or nuclear energy into electric energy. A plant may contain more than one type of prime mover. Electric utility plants exclude facilities that satisfy the definition of a qualifying facility under the Public Utility Regulatory Policies Act of 1978.

Plant-Use Electricity: The electric energy used in the operation of a plant. This energy total is subtracted from the gross energy production of the plant; for reporting purposes the plant energy production is then reported as a net figure. The energy required for pumping at pumped-storage plants is, by definition, subtracted, and the energy production for these plants is then reported as a net figure.

Power: The rate at which energy is transferred. Electrical energy is usually measured in watts. Also used for a measurement of capacity.

Power Pool: An association of two or more interconnected electric systems having an agreement to coordinate operations and planning for improved reliability and efficiencies.

(In Texas, generating plants are primarily in the Electric Reliability Council of Texas. In addition a few plants are members of other power pools such as the Southwest Power Pool, Southeastern Electric Reliability Council, Western States Coordinating Council)

Prime Mover: The engine, turbine, water wheel, or similar machine that drives an electric generator; or, for reporting purposes, a device that converts energy to electricity directly (e.g., photovoltaic solar and fuel cell(s)).

Pumped-Storage Hydroelectric Plant: A plant that usually generates electric energy during peak-load periods by using water previously pumped into an elevated storage reservoir during off-peak periods when excess generating capacity is available to do so. When additional generating capacity is needed, the water can be released from the reservoir through a conduit to turbine generators located in a power plant at a lower level.

PURPA: The Public Utility Regulatory Policies Act of 1978, passed by the U.S. Congress. This statute requires States to implement utility conservation programs and create special markets for co-generators and small producers who meet certain standards, including the requirement that States set the prices and quantities of power the utilities must buy from such facilities.

Qualifying Facility (QF): A cogeneration or small power production facility that meets certain ownership, operating, and efficiency criteria established by the Federal Energy Regulatory Commission (FERC) pursuant to the Public Utility Regulatory Policies Act (PURPA).

Regulation: The governmental function of controlling or directing economic entities through the process of rulemaking and adjudication.

Renewable Resources: Naturally, but flow-limited resources that can be replenished. They are virtually inexhaustible in duration but limited in the amount of energy that is available per unit of time. Some (such as geothermal and biomass) may be stock-limited in that stocks are depleted by use, but on a time scale of decades, or perhaps centuries, they can probably be replenished. Renewable energy resources include: biomass, hydro, geothermal, solar and wind. In the future, they could also include the use of ocean thermal, wave, and tidal action technologies. Utility renewable resource applications include bulk electricity generation, on-site electricity generation, distributed electricity generation, non-grid-connected generation, and demand-reduction (energy efficiency) technologies.

Reserve Margin (Operating): The amount of unused available capability of an electric power system at peakload for a utility system as a percentage of total capability.

Residential: The residential sector is defined as private household establishments which consume energy primarily for space heating, water heating, air conditioning, lighting, refrigeration, cooking and clothes drying. The classification of an individual consumer's account, where the use is both residential and commercial, is based on principal use. For

the residential class, do not duplicate consumer accounts due to multiple metering for special services (water, heating, etc.). Apartment houses are also included.

Residual Fuel Oil: The topped crude of refinery operation, includes No. 5 and No. 6 fuel oils as defined in ASTM Specification D396 and Federal Specification VV-F-815C; Navy Special fuel oil as defined in Military Specification MIL-F-859E including Amendment 2 (NATO Symbol F-77); and Bunker C fuel oil. Residual fuel oil is used for the production of electric power, space heating, vessel bunkering, and various industrial purposes. Imports of residual fuel oil include imported crude oil burned as fuel.

Running and Quick-Start Capability: The net capability of generating units that carry load or have quick-start capability. In general, quick-start capability refers to generating units that can be available for load within a 30-minute period.

Small Power Producer (SPP): Under the Public Utility Regulatory Policies Act (PURPA), a small power production facility (or small power producer) generates electricity using waste, renewable (water, wind and solar), or geothermal energy as a primary energy source. Fossil fuels can be used, but renewable resource must provide at least 75 percent of the total energy input. (See Code of Federal Regulations, Title 18, Part 292.)

Spurge: Spray or disperse

Spinning Reserve: That reserve generating capacity running at a zero load and synchronized to the electric system.

Standard Industrial Classification (SIC): A set of codes developed by the Office of Management and Budget, which categorizes business into groups with similar economic activities.

Standby Facility: A facility that supports a utility system and is generally running under no-load. It is available to replace or supplement a facility normally in service.

Steam-Electric Plant (Conventional): A plant in which the prime mover is a steam turbine. The steam used to drive the turbine is produced in a boiler where fossil fuels are burned.

Stocks: A supply of fuel accumulated for future use. This includes coal and fuel oil stocks at the plant site, in coal cars, tanks, or barges at the plant site, or at separate storage sites.

Subbituminous Coal: A coal whose properties range from those of lignite to those of bituminous coal and are used primarily as fuel for steam-electric power generation. It may be dull, dark brown to black, soft and crumbly at the lower end of the range, to bright, jet black, hard, and relatively strong at the upper end. Subbituminous coal contains 20 to 30 percent inherent moisture by weight. The heat content of subbituminous

coal ranges from 17 to 24 million Btu per ton on a moist, mineral-matter-free basis. The heat content of subbituminous coal consumed in the United States averages 17 to 18 million Btu per ton, on the as-received basis (i.e., containing both inherent moisture and mineral matter).

Sulfur: One of the elements present in varying quantities in coal which contributes to environmental degradation when coal is burned. In terms of sulfur content by weight, coal is generally classified as low (less than or equal to 1 percent), medium (greater than 1 percent and less than or equal to 3 percent), and high (greater than 3 percent). Sulfur content is measured as a percent by weight of coal on an "as received" or a "dry" (moisture-free, usually part of a laboratory analysis) basis.

Transformer: An electrical device for changing the voltage of alternating current.

Transmission System (Electric): An interconnected group of electric transmission lines and associated equipment for moving or transferring electric energy in bulk between points of supply and points at which it is transformed for delivery over the distribution system lines to consumers, or is delivered to other electric systems.

Turbine: A machine for generating rotary mechanical power from the energy of a stream of fluid (such as water, steam, or hot gas). Turbines convert the kinetic energy of fluids to mechanical energy through the principles of impulse and reaction, or a mixture of the two.

Useful Thermal Output: The thermal energy made available for use in any industrial or commercial process, or used in any heating or cooling application, i.e., total thermal energy made available for processes and applications other than electrical generation.

Watt: The electrical unit of power. The rate of energy transfer equivalent to 1 ampere flowing under a pressure of 1 volt at unity power factor.

Watt-hour (Wh): An electrical energy unit of measure equal to 1 watt of power supplied to, or taken from, an electric circuit steadily for 1 hour.

Wholesale Competition: A system whereby a distributor of power would have the option to buy its power from a variety of power producers, and the power producers would be able to compete to sell their power to a variety of distribution companies.

Wholesale Sales: Energy supplied to other electric utilities, cooperatives, municipalities, and Federal and State electric agencies for resale to ultimate consumers.

Wholesale Power Market: The purchase and sale of electricity from generators to resellers (who sell to retail customers), along with the ancillary services needed to maintain reliability and power quality at the transmission level.

Appendix H
Executive Administrator's Comments on Draft Report

ATTACHMENT 1
TEXAS WATER DEVELOPMENT BOARD
Review of the Draft Final Report: Contract No. 2001-483-396
“Power Generation Water Use in Texas for the Years 2000 through 2060”

1. The methodology appears sound, however for staff to utilize the data located in the appendices, further meetings or phone calls with Greg Carter will be necessary. I'm looking forward to receiving the tables in electronic format (Excel).
2. Please provide an overview of summary of the steam electric power plants included in this study; such as the total number of the plants, if possible dropped or added compared to the last plan. Does the recent announcement of AEP's intention to close plants have any impact on the study?
3. Please explain why some of the power plants have blank fields with no data.
4. In Section 6, please provide an example of how a county's water demand is derived, with an explanation of how a county's demand can decline through 2020 and increase thereafter. (All reviewers made a variation of this comment, requesting more clarity regarding the derivation of county demands.)
5. The tables attached in the appendix were difficult to figure out. It would be helpful if those have footnotes for abbreviations used in the tables, data source for each table, explanations for the formulas or variables.
6. Appendix D (pp76) Annual Statewide Steam Electric Water Supply vs. Demand: the 6th column from the left, 'Study Minus TWDB Supply' should be changed to 'TWDB Supply Minus Study Demand'
7. Appendix B2: Please clarify whether the data was from the State Data Center or TWDB Projection numbers.