

CONTRACT ADMINISTRATION
2013 MAY -2 AM 7:21

Guidance Manual

Fiberglass Casing Use in Texas Public Supply Wells

Prepared for: 1104831108 Final Report

Texas Water Development Board



Prepared by:



In association with:



Guidance Manual

Fiberglass Casing Use in Texas Public Supply Wells

Prepared for:

Texas Water Development Board



Prepared by:



In association with:



This page left intentionally blank

Foreword

In 2004, North Alamo Water Supply Corporation began developing a brackish groundwater supply in response to limited surface water availability and increasing demands due to a rapidly growing population. Since then, a large amount of information has been learned about the previously undeveloped brackish groundwater aquifers in South Texas. This document represents another tool that increases the knowledge base in the State of Texas by introducing new materials and methods of brackish groundwater development. Fiberglass casing has the potential for addressing some of the cost and corrosion resistance issues associated with the development of brackish water resources.

We thank the Texas Water Development Board for assisting us in furthering the science and technology to best develop these sorts of supplies.

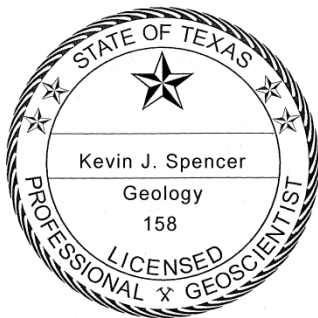

The seal appearing on this document was authorized by Kevin J. Spencer, P.G. 158 on April 28, 2013. Firm Registration Number: 50033.

A handwritten signature in black ink, reading "Kevin J. Spencer", written over a horizontal line.

Kevin J. Spencer, P.G.
President, R.W. Harden & Associates, Inc.



The seal appearing on this document was authorized by Robert Harden, P.E. 79290 on April 17, 2013. Firm Registration Number: F-1524.

A handwritten signature in black ink, reading "Bob Harden", written over a horizontal line.

Bob Harden, P.E.
Vice President, R.W. Harden & Associates, Inc.



The seal appearing on this document was authorized by Jesus Leal III, P.E. 82006 on April 28, 2013. Firm Registration Number: F-14803.

A handwritten signature in blue ink, reading "Jesus Leal", written over a horizontal line.

Jesus Leal, P.E.
Principal, Norris Leal PLLC

A handwritten signature in blue ink, reading "Steven Sanchez", written over a horizontal line.

Steven Sanchez, General Manager
North Alamo Water Supply Corporation

This page left intentionally blank

Executive Summary

The goal of the Texas Water Development Board in publishing this Guidance Manual is to further the science, knowledge, and use of fiberglass casing in construction of brackish groundwater wells in Texas. Texas is blessed with an abundance of groundwater resources, but historically most groundwater developments targeted fresh groundwater supplies and brackish treatment costs were prohibitive. The lack of brackish groundwater use has precluded the value that experience provides. In the future, use of brackish groundwater is likely to increase in the State of Texas as water demands grow and existing fresh water supplies become less available. Because of treatment costs, brackish groundwater is more suited for industrial or municipal use.

Development of brackish groundwater supplies requires specific well designs to address the potential for corrosion. Generally, carbon steel is too susceptible to corrosion to be a reliable choice for well design. Stainless steel is one viable option but is relatively expensive. PVC is another alternative material to address corrosion, but is oftentimes not strong enough or too fragile to be ideal for use. Fiberglass casing is another alternative that offers corrosion resistance and may have suitable strength in some applications.

This Guidance Manual highlights the experience of North Alamo Water Supply Corporation in developing a brackish groundwater supply. Two identical wells were designed and constructed; one well using industry standard stainless steel design and one well using fiberglass casing as an alternative. This experience highlights that fiberglass casing is less expensive and of adequate strength for use in many brackish groundwater wells. Certain alternative design and construction techniques were required and these are highlighted herein. Also, current State law regarding permitting of public supplies is reviewed.

This page left intentionally blank

Contents

Foreword.....	i
Executive Summary	iii
Introduction.....	1
Case Study	2
Background.....	5
Brackish Groundwater Overview.....	5
Groundwater Development Overview	8
Use of Fiberglass Casing in Public Supply Wells in Other States	9
Why Fiberglass?.....	11
TCEQ Approved Casings Material	11
Collapse Strength.....	12
Corrosion Resistance	12
Heat Tolerance	13
Availability	13
Cost	13
Fiberglass Well Casing	13
Fiberglass Potential Use.....	14
Fiberglass Advantages and Disadvantages	14
Fiberglass Certifications	15
Existing Uses of GreenThread	16
Selection of Casing Material.....	17
Resistance to Hydraulic Collapse Pressure.....	17
Tensile Strength	21
Corrosion in Water Wells	22
Identifying the Potential for Corrosion	23
Case Study - NAWSC Donna Project.....	25
Owner Involvement	25
Preliminary Considerations.....	26
Selection of Material Supplier	27
Preliminary Regulatory Meetings	27

Selection of Casing Materials	27
Corrosion Resistance	28
Resistance to Hydraulic Collapse	28
Well Head Flange	29
Casing Diameter.....	29
Fiberglass Couplings.....	29
Reducing Amount of Cement in the Casing	31
Regulatory Submittals and Approval for Use	31
Cost Evaluation.....	31
Construction.....	32
Material Delivery Time.....	32
Initial Inspection	32
Casing Joints	33
Coupling Installation.....	34
Centralizers	35
Casing Cementing.....	35
Production Zone Drilling	35
References.....	37
Appendices.....	39
Appendix A: GreenThread Pipe Product Data.....	41
Appendix B: Applicable Fiberglass Well Casing Regulations in Other States.....	47
Appendix C: GreenThread Pipe Chemical Resistance.....	53
Appendix D: GreenThread Pipe General Specifications	75
Appendix E: GreenThread Certifications	79
Appendix F: Fiberglass Well Construction Correspondence.....	85
Appendix G: GreenThread Pipe Coupling System Schematics	91
Appendix H: TCEQ Variance Request Correspondence	95
Appendix I: Test Drilling Report.....	103

Tables

Table 1. Project Team Members	3
Table 2. Brackish Groundwater Stored in Texas Aquifers	7
Table 3. Approved Well Casing Material Properties.....	12
Table 4. ASTM Standards Description	16
Table 5. Pressure on Base of Well Casing Exerted During Cementing Process	21
Table 6. Tensile Strength of Casing Materials	22
Table 7. Common Corrosion Related Constituents in Texas Groundwater	23
Table 8. Strength of GreenThread 250 Coupling System	30
Table 9. Sample Casing Material Cost Comparison	32

Figures

Figure 1 Groundwater Quality in Texas, 2003.....	6
Figure 2 Vertical and Horizontal Water Quality Variation	8
Figure 3 States giving exceptions for Fiberglass Wells	10
Figure 4 GreenThread Filament Winding Process	13
Figure 5 Well Schematic: Float Shoe	18
Figure 6 Well Schematic: Open Telescoping	18
Figure 7 Well Schematic: Straight wall	20

Addendum

Texas Water Development Board Comments and Authors' Responses

Attachments

DVD Down Hole Video of Fiberglass-Cased Well, Donna #2

DVD Narrative Description

This page left intentionally blank

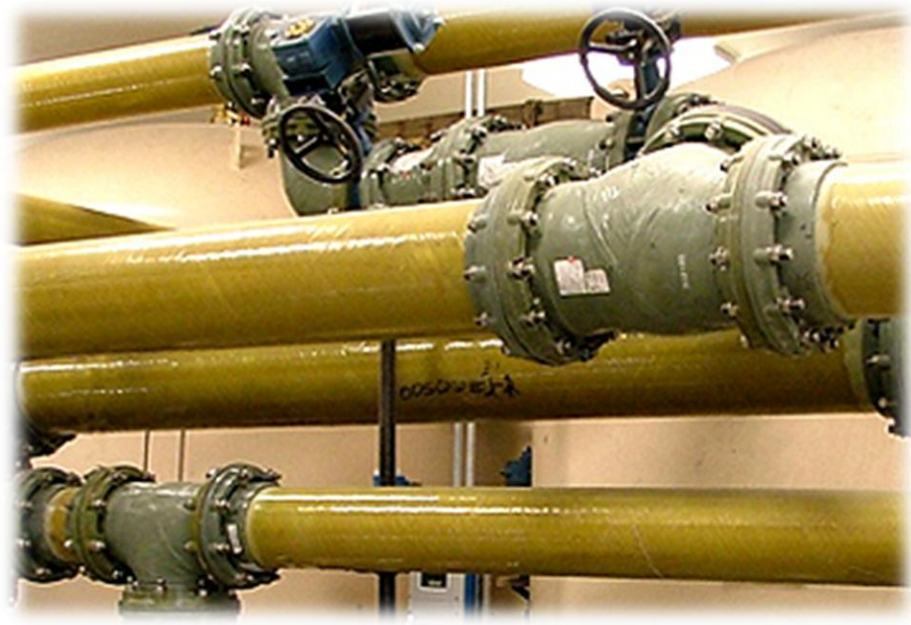

Introduction

In Texas, virtually all municipal groundwater wells are constructed with carbon steel, polyvinyl chloride (PVC), or stainless-steel casings. Increasingly, treated brackish groundwater has become an option for water suppliers. Overwhelmingly, stainless-steel is the well construction material of choice for brackish water wells because of its corrosion resistance, strength, and widespread availability. PVC casing is common in lower-capacity wells because it is relatively inexpensive and provides excellent resistance to corrosion; however, there are significant strength limitations associated with PVC that generally preclude its use in deep and/or large diameter wells. Fiberglass well casing provides an alternative to stainless-steel and PVC where strength and corrosion resistance are needed to ensure long-term well integrity is maintained in brackish groundwater and corrosive environments. Fiberglass-cased wells have been used in the oil industry for decades, and have been used in other states in water well applications for the last 30 years. However, fiberglass casing in Texas public supply wells is relatively new because of the relative abundance of fresh groundwater supplies. Recently, reverse osmosis treatment costs have been reduced, and brackish groundwater has become an attractive option for some public water supply operators. As use of brackish groundwater resources become more commonplace, a demand for new material and methods is being created.

The purpose of this manual is to provide guidance concerning the engineering, regulatory, and construction issues pertaining to the use of fiberglass casing in public supply wells in Texas.



Fiberglass casing ready for installation at NAWSC

Case Study

North Alamo Water Supply Corporation (NAWSC) is a private non-profit water supplier in southern Texas, serving over 900 square miles in portions of Hidalgo, Cameron, and Willacy Counties. Historically, NAWSC has relied on surface water supplies, but has increasingly turned to brackish groundwater to satisfy growing demands due to its favorable cost and high drought tolerance. To date, NAWSC has built four brackish groundwater treatment plants to supplement existing surface water supplies.

Until 2012, all of NAWSC's brackish groundwater wells were constructed with stainless-steel casing due to its corrosion resistance, availability, and acceptance by the Texas Commission on Environmental Quality (TCEQ) as a well casing material for public supply wells. However, because stainless-steel casing is relatively expensive and its price volatile, NAWSC sought to

identify alternative materials and methods of well construction that would provide a satisfactory well life at reduced costs. Fiberglass was identified as a potential alternative well casing material because of its high corrosion resistance, favorable cost, and strength.

A case study was performed to document and contrast the various attributes of fiberglass versus stainless-steel casing. The study consisted of designing, permitting, constructing, and operating two similar wells to supply a new brackish groundwater reverse-osmosis (RO) treatment plant in Hidalgo County. The plant is designed to supply two million gallons per day of treated groundwater produced from the two wells. One of the wells was constructed with stainless-steel casing while the other was constructed with fiberglass casing so that comparisons between the materials and costs could be made.

Project Team

Table 1 lists the project team and role in selection and use of fiberglass casing for this application.

Table 1. Project Team Members	
Team Member	Role
R.W. Harden and Associates Inc., Austin, Texas	Responsible for project hydrology, design, permitting, construction oversight, and testing of the public supply wells
North Alamo Water Supply Corporation, Edinburg, Texas	Project owner
NRS Consulting Engineers, Harlingen, Texas	Design engineer for the RO treatment plant
Texas Water Development Board, Austin, Texas	Provided partial project funding for the fiberglass cased well
Texas Commission on Environmental Quality, Austin, Texas	Provided regulatory guidance for the acceptance of fiberglass casing in municipal wells
NOV Fiberglass Systems	Fiberglass casing manufacturer; provided technical, design and product testing information needed for regulatory approval
Alsay Incorporated, Houston, Texas	Well construction contractor

Decision Process

The decision to pursue the use of fiberglass casing in a municipal water well was a cooperative process that began with the RO Plant engineer, hydrologist, project owner, and manufacturer working together to identify cost saving measures. The TCEQ provided valuable regulatory guidance to outline the information needed to gain state approval to use fiberglass casing in a public supply well. Following interviews with several drilling contractors to determine their willingness to work with fiberglass casing, it was determined that contractor

willingness was not a restriction; Alsay Incorporated was selected for well construction because they were the low bidder. In addition, the Texas Water Development Board (TWDB), recognizing the potential benefits to developing alternate municipal water supplies at lower costs, provided partial funding for this effort. This funding was critical to the owner's willingness to experiment with a product that was not known to have been previously used in Texas for this application.

This page left intentionally blank

Background

The primary purpose of this manual is to provide guidance to entities considering the use of fiberglass casing in wells used to produce brackish water for public supplies. Although this manual primarily focuses on the use of fiberglass casing for brackish groundwater applications, its application extends to all groundwater, including fresh groundwater that may have corrosive properties. In general, development of brackish groundwater is only implemented in areas where other supplies are not available from physical, financial, or regulatory standpoints. Consequently, it is expected that the use of corrosion-resistant casing material will be concentrated in areas where brackish water provides a cost-effective source for satisfying future demands. The following sections provide background information relating to the distribution and availability of brackish groundwater supplies in Texas, as well as the steps typically required for development of a municipal well field.

Brackish Groundwater Overview

Depending on the unique circumstances facing a public supply entity, brackish groundwater may represent an attractive water supply alternative. Typically, there are many combinations of factors contributing to the desirability of developing brackish supplies. Some of the most common include: 1) decreasing availability or reliability of surface water supplies, 2) increasing demand in areas where other groundwater supplies are unavailable, 3) decreased costs due to improvements in treatment processes and/or technologies, 4) inability of current supplies to meet stricter state drinking water standards, 5) supply diversity and 6) economic considerations of increasing costs for alternative supplies.

Abundant brackish groundwater resources can be found in most Texas aquifers. However, because the majority of municipal water suppliers have historically sought fresh groundwater supplies, data on the quantity of available brackish groundwater resources are generally sparse. With the exception of portions of southern and western Texas, data regarding the extent and quality of brackish groundwater resources was, in general, not deliberately sought. Rather, brackish water information has largely been recorded when brackish water was unintentionally encountered by those seeking fresh water.

However, there are some “planning tool” levels of information for brackish groundwater supplies in many areas of Texas. Common examples of available data sources include petroleum industry geophysical log libraries and reports/maps produced by state agencies such as the TWDB. Knowing how to access and interpret this information can greatly improve the success (and reduce the cost) of assessing brackish groundwater availability. Detailed descriptions of the various data sources and their uses are beyond the scope of this manual; it is recommended that entities wishing to explore the potential availability of brackish groundwater consult with a professional hydrogeologist or engineer for guidance.

The productivity and quality of the brackish groundwater resources vary widely and must be evaluated on a case-by-case basis. Figure 1 shows the general extent and quality of known

groundwater resources in Texas (LGB-Guyton, 2003). Specifically, Figure 1 shows the distribution of the water quality records maintained by the TWDB for wells completed in a variety of aquifers at different depths. The water quality values represented in Figure 1 are generally heavily weighted toward fresh water because well drillers and groundwater users commonly target strata containing fresh water. Consequently, the areas indicated as containing fresh water may also overlay formations containing brackish water, but, because no wells were completed in the poorer-quality formations, no brackish water samples were recorded at the site.

The concentration of total dissolved solids (TDS) is often used as a general indicator of groundwater mineralization. For reference, water with TDS concentrations of less than 1,000 mg/l is labeled “fresh” by the Texas TCEQ, while concentrations of more than 1,000-10,000 mg/l are typically considered brackish to moderately saline; seawater contains about 35,000 mg/l TDS. Table 2 summarizes the quantity of stored brackish groundwater in the minor and major aquifers of Texas. As shown, the aquifers of Texas contain a total of about 2.7 billion acre-feet of brackish groundwater.

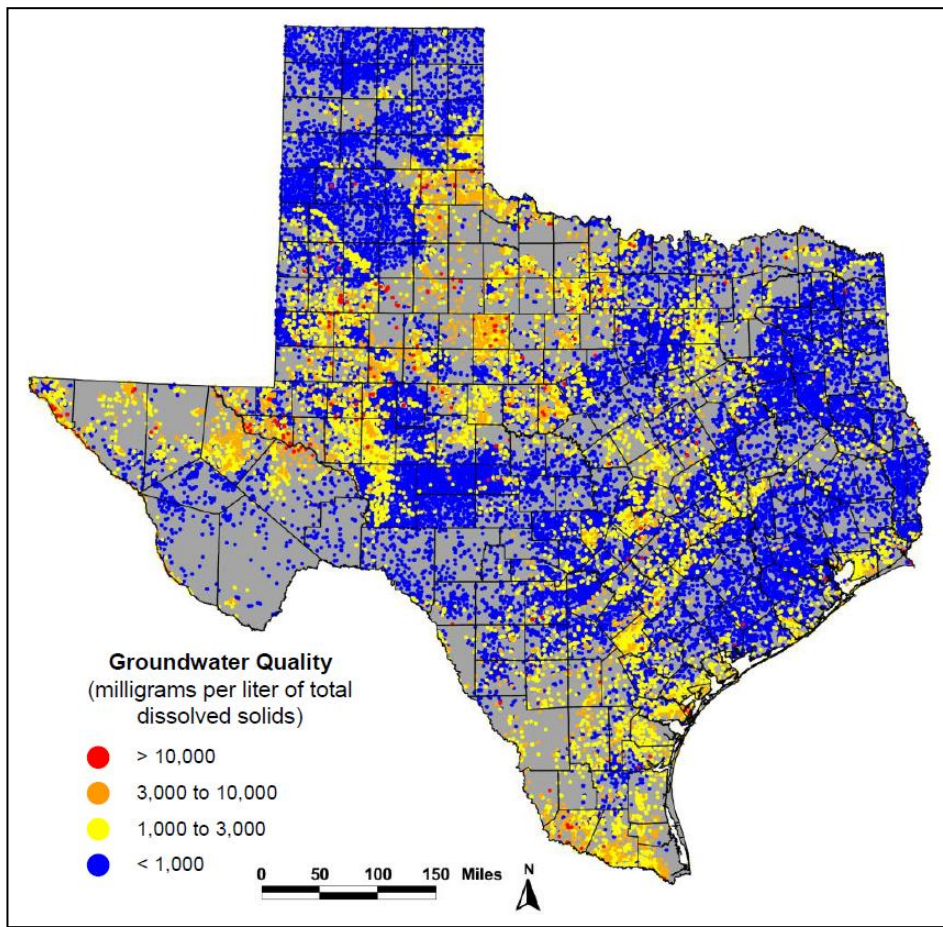

Figure 1
Groundwater
Quality in Texas,
2003

Figure reproduced from LBG-Guyton Associates, 2003

Table 2. Brackish Groundwater Stored in Texas Aquifers

Aquifer	Volume of Water (acre-feet)		
	1,000 - 3,000 mg/L TDS water	3,000 - 10,000 mg/L TDS water	Total: 1,000 - 10,000 mg/L water
Major Aquifers			
Carrizo-Wilcox	270,024,000	160,157,000	430,181,000
Cenozoic Pecos Alluvium	114,048,000	2,534,000	116,582,000
Edwards-BFZ	14,394,000	24,795,000	39,189,000
Edwards-Trinity (Plateau)	22,383,000	1,968,000	24,351,000
Gulf Coast	352,945,000	167,328,000	520,273,000
Hueco Bolson	24,491,000	0	24,491,000
Mesilla Bolson	480,000	0	480,000
Ogallala	32,731,000	3,494,000	36,225,000
Seymour	2,280,000	0	2,280,000
Trinity	97,451,000	80,714,000	178,165,000
Total	931,227,000	440,990,000	1,372,217,000
Minor Aquifers			
Blaine	8,672,000	10,944,000	19,616,000
Blossom	1,089,000	320,000	1,409,000
Bone Spring-Victorio Peak	6,400,000	2,560,000	8,960,000
Capitan Reef	54,333,000	20,375,000	74,708,000
Dockum	59,473,000	65,466,000	124,939,000
Edwards-Trinity (High Plains)	5,750,000	131,000	5,881,000
Ellenburger-San Saba	18,124,000	28,362,000	46,486,000
Hickory	68,898,000	49,213,000	118,111,000
Lipan	1,202,000	48,000	1,250,000
Nacatoch	10,859,000	3,395,000	14,254,000
Queen City-Sparta	167,281,000	78,431,000	245,712,000
Rustler	18,429,000	18,429,000	36,858,000
West Texas Bolsons	6,362,000	0	6,362,000
Whitehorse-Artesia	898,000	16,143,000	17,041,000
Woodbine	17,282,000	26,485,000	43,767,000
Yegua-Jackson	324,864,000	192,993,000	517,857,000
Total	769,916,000	513,295,000	1,283,211,000

Derived from LBG-Guyton Associates, 2003

In many Texas aquifers, water quality becomes more mineralized (brackish) with depth. This increased mineralization often occurs in a down-dip direction within a single aquifer, as well as vertically within a single aquifer zone (Figure 2.) The significance of the lateral and vertical variation in water quality within a single aquifer zone and the vertical water quality variation in different overlying aquifers should be considered when evaluating brackish groundwater resources.

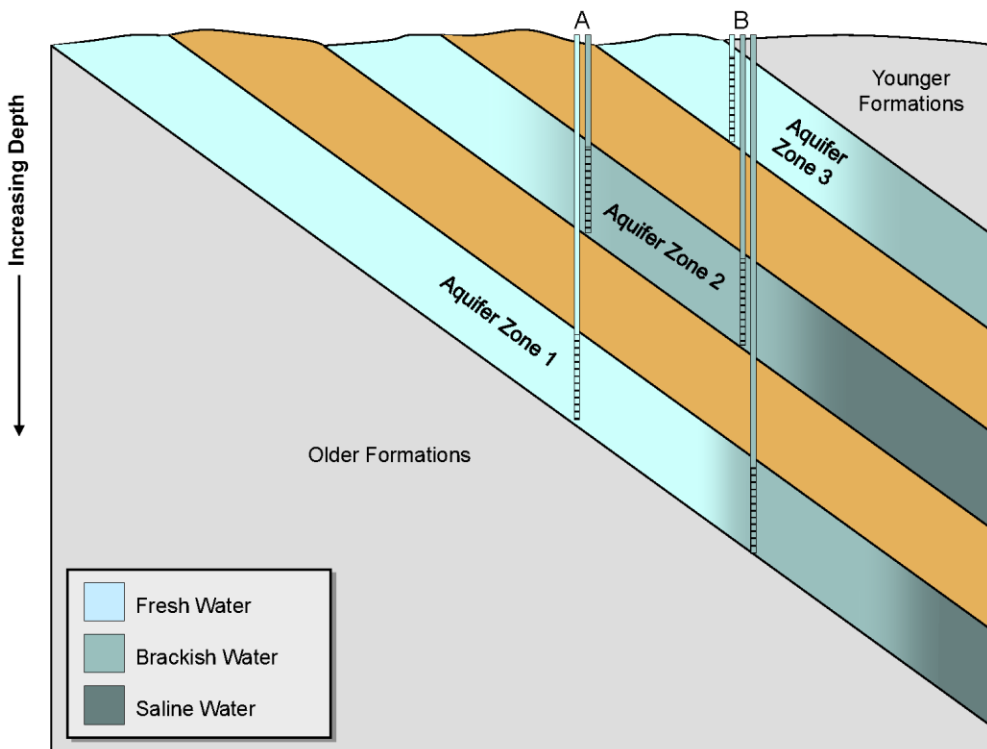

Figure 2
Vertical and
Horizontal Water
Quality Variation

Groundwater Development Overview

Similar processes are used to develop most groundwater supplies, whether they are fresh or brackish. In general, a phased approach is preferred where project tasks progress from initial study and exploration to final system design and construction. A phased approach allows the project to move forward in a methodical manner, and potential risks (or fatal flaws) can be identified early in the process while reducing the capital investment. Furthermore, as new information is developed, the scope of additional work can be tailored to the unique aspects of the project. The following phases are commonly employed for groundwater development projects:

- ***Preliminary Investigation*** – Compilation and evaluation of available information pertaining to the availability of groundwater resources in a target area. The availability is evaluated with respect to both hydrogeological and regulatory issues. The primary goals

of the study are to identify potential aquifer zones and to estimate long-term groundwater availability and quality.

- **Field exploration and study refinement** – Assuming the preliminary investigation indicates a reasonable probability of obtaining groundwater supplies that meet the quantity and quality requirements for the project, field testing of the aquifer is often required to obtain site-specific information for the proposed well field. This information can include: test drilling, aquifer testing, water quality sampling, sand sampling, geophysical logging, and geophysical studies of the subsurface. This information, combined with regional information developed in the preliminary investigation, is frequently combined to create a groundwater model to simulate the aquifer’s response to long-term pumping.
- **Well field design** – If the results of the previous studies are favorable, a well field design is developed that includes specific locations for wells, piping, and electrical infrastructure.
- **Permitting** – In areas of the state where a groundwater conservation district regulates groundwater pumping, permits are typically required for test drilling, well construction, and groundwater production.
- **Final design and Contractor Bidding** – After permits are secured for the project, each well is designed for the specific characteristics of the aquifer at each well location. Upon completion of the well design, TCEQ approval of the design and well head sanitary controls is needed prior to well construction. Contractor bidding typically takes place during TCEQ review as a time-saving measure.
- **Construction** – Upon TCEQ approval to construct, receipt of contractor bids, owner approval and, if applicable, groundwater conservation district permitting, well construction is initiated.

Use of Fiberglass Casing in Public Supply Wells in Other States

Currently, fiberglass municipal well casing is approved in Florida, Nebraska, and Arkansas. Although other states may not explicitly approve fiberglass, the exception process for unconventional municipal well casing is streamlined and does not pose a significant hurdle for well construction. The states which allow fiberglass casing, or have given exceptions for fiberglass casing are shown on Figure 3.

Fiberglass public supply well casing is extensively used in Florida as a substitute for stainless steel. Companies such as Burgess Fiberglass, NOV Fiberglass Systems, and GP Fiberglass are the most recognized fiberglass casing manufacturers that have gained approval to install fiberglass casings in public supply wells.

Figure 3
States giving
exceptions for
Fiberglass Wells

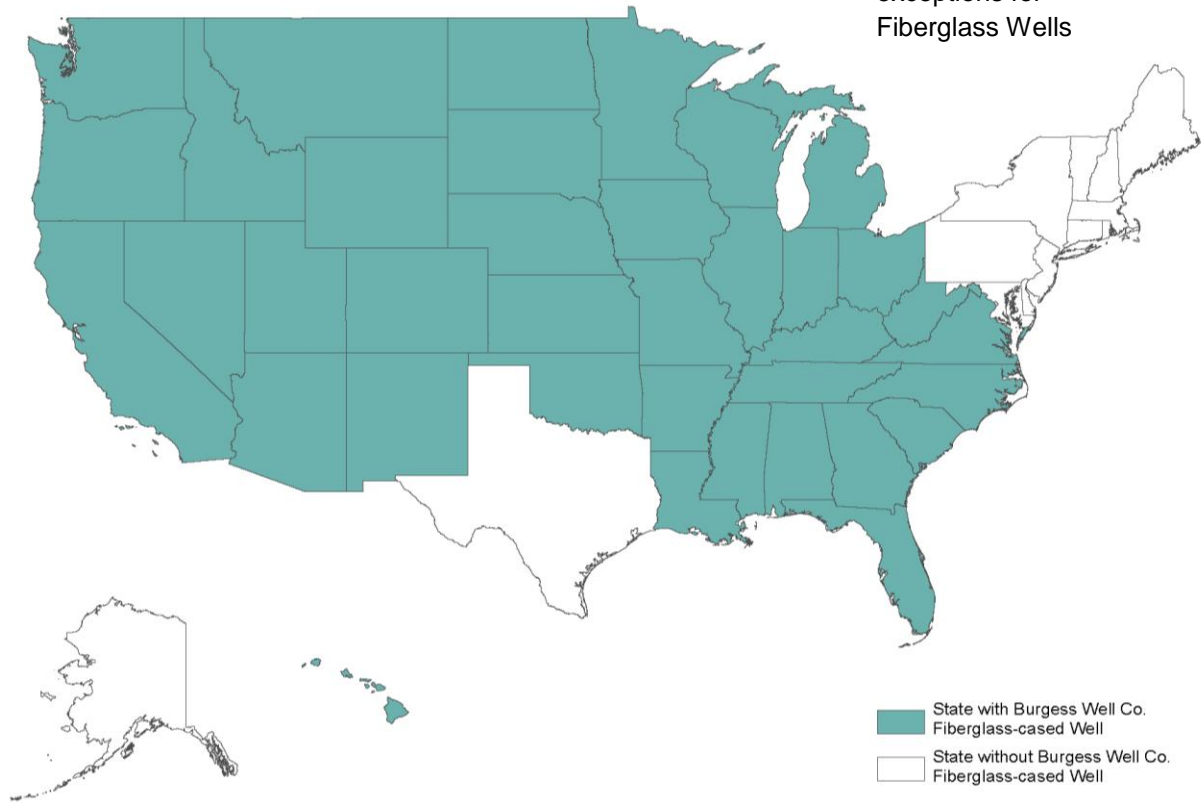

Why Fiberglass?

Fiberglass pipe can be a practical choice for various water supply projects where a low-cost, corrosion-resistant well casing is required and engineering constraints can be met. Because it is economical, light-weight, durable and corrosion-resistant, fiberglass piping is currently used worldwide as an alternative to steel or concrete. Fiberglass has potential benefits in many Texas water well construction applications due to its low cost and corrosion resistance as compared to currently accepted water well materials. Although not always an appropriate well material, fiberglass provides a new option for Texas water well construction projects that can benefit all parties involved.

TCEQ Approved Casings Material

Design approval and construction methods for public water supply wells are regulated in the state of Texas by the TCEQ. The TCEQ has created rules directing the construction of public water systems, which include the materials acceptable in water well construction. These rules grant approval for wells constructed using “new carbon steel, high-strength low-alloy steel, stainless steel or plastic” that conforms to American Water Well Association (AWWA) standards (Texas Administration Code T30, Chapter 290.41(c)(3)(B)). Polyvinyl chloride (PVC) is the most common, and perhaps the only plastic used in public water systems.

Casing materials that have an AWWA standard have compositions which differentiate their use in the water well field:

Carbon Steel – This type of casing is used predominantly in fresh water wells and is, by far, the most common public supply well casing in Texas.

High-Steel Low-Alloy Steel (HSLA) – Rather than having a defined chemical composition, HSLA is produced with a goal of attaining certain mechanical properties. HSLA steel casing can be formulated to have a moderate resistance to corrosion and improvements in strength over carbon steel, allowing it to be used in deeper wells or wells with mildly corrosive water. Because the composition of HSLA is project-specific, delivery times of HSLA may be longer than carbon or stainless steel.

Stainless Steel – Composed of at least 50% iron and at least 10.5% chromium, the family of stainless steel is quite large and specialized. There are hundreds of grades and sub grades, with each designed for a special application. In the water well industry, Type 304 and 316L are often used and can provide corrosion resistance for wells with moderate salt content and/or corrosivity, where carbon or HSLA steel would provide inadequate corrosion protection. Other types of stainless steel can provide even greater corrosion resistance in high chloride and/or low pH environments.

PVC – Composed of polyvinyl chloride resin, this type of casing is typically used in shallow wells. It lacks the strength of steel and is susceptible to further strength reductions due to the heat of hydration associated with the curing of cement during annular sealing.

The selection of well casing is project-specific and primarily dependent on the depth of the well and the corrosiveness of the water. Other major considerations in the choice of well casing include water quality, availability, heat tolerance, and price. Table

3 lists the four TCEQ approved well casing materials and a relative assessment of their characteristics. A general description of each characteristic is provided below.

Table 3. Approved Well Casing Material Properties					
Material	Collapse Strength	Corrosion Resistance	Heat Tolerance	Availability	Cost
Carbon Steel	High	Poor	High	Good	Low
High-Steel Low Alloy Steel	High	Moderate	High	Poor	Moderate to High
Stainless Steel	High	Moderate to High	High	Moderate to Good	High
PVC	Low to moderate	High	Low	Good	Very Low

Partially reproduced from <http://www.burgesswell.com/comp.htm>

Collapse Strength

Carbon steel, HSLA, and stainless steel casing have relatively high resistance to hydraulic collapse, allowing for installation to depths great enough for any public water supply well, provided an appropriate wall thickness is used. HSLA steel can be formulated to withstand even higher external compression for use in larger diameter deep wells. Due to low resistance to hydraulic collapse, PVC casing is typically used in smaller diameter and shallow wells of less than a few hundred feet. Fiberglass offers higher resistance to hydraulic collapse than PVC, but significantly less than steel.

Corrosion Resistance

Corrosion in well casing typically results from electrochemical oxidation or formation of a galvanic couple between dissimilar

metals. Corrosive groundwater can cause a well casing to deteriorate if proper casing materials are not selected. Pitting and formation of iron oxides can shorten the life of carbon steel casing, potentially causing turbidity in the well, failure of the annular seal, and increased dissolved iron content of the produced water. Due to their corrosion resistance, stainless steel and PVC are more suited materials in brackish water environments. HSLA steel may be suitable for some mildly corrosive waters. Stainless steel provides superior corrosion resistance to HSLA, and PVC can be superior to stainless in saline environments. Fiberglass offers similar resistance to corrosion as PVC.

Heat Tolerance

The curing of cement-based annular grouts is an exothermic reaction and can produce temperatures that can weaken some well casing materials. Although the increased borehole temperatures are generally not a problem for steel which maintains its strength at temperatures encountered during the curing of cement grouts, PVC begins to weaken at temperatures above 75° F. Some well construction methods can help mitigate this loss of strength, but without detailed information on down hole temperatures, the use of PVC should include a significant safety factor, and/or preventive measures to reduce casing temperatures during cement curing. Although fiberglass also loses strength with heat, its tolerance to heat is significantly better than PVC.

Availability

While carbon steel, stainless steel and PVC are typically available in a period of days (or perhaps weeks in the case of stainless steel), HSLA can take weeks to become available due to specific formulations for individual projects. Fiberglass availability may require long lead times for construction because it is constructed for a specific application. While the ability to custom order well casing can reduce cost, it requires careful planning.

Cost

Well material costs have maintained consistent relationships, with PVC being lowest, followed by carbon steel, HSLA, and stainless steel. Type 316 stainless steel, the most corrosive resistant of commonly used steel casing materials, can cost 8 to 10 times more than carbon steel depending on current metal prices which can be volatile.

Fiberglass is typically more expensive than carbon steel, but significantly less than stainless steel, with prices tied to current world oil prices.

Fiberglass Well Casing

NOV Fiberglass Systems GreenThread piping is specially constructed of a glass reinforced epoxy (GRE) resin material. The resin is a thermosetting aromatic amine-cured epoxy reinforced with continuous glass fibers. The GreenThread structure is created by a filament winding process, where resin-impregnated glass fibers are wound onto a mandrel in a predetermined pattern under a controlled tension (Figure 4). Keyed couplings and fiberglass adapters are used to join lengths of pipe.

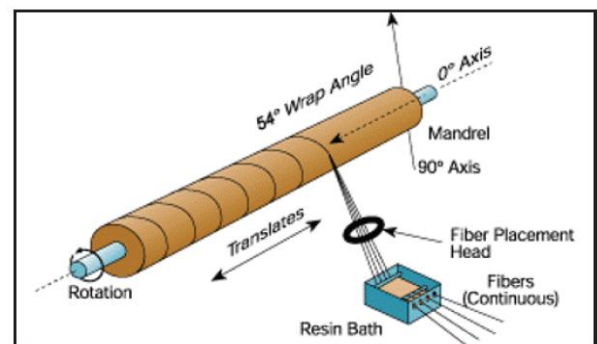

Figure courtesy of NOV Fiberglass Systems

Figure 4

GreenThread
Filament Winding
Process

Aromatic amine cured epoxies have superior temperature resistance in water applications over other types of epoxies and particularly vinyl ester thermosetting resins. This epoxy system does not use styrene as a diluent like vinyl esters and coupled with the heat curing

process allows for compliance with the NSF Standard 61 for drinking water applications.

Product data for GreenThread pipe can be found in Appendix A.

Fiberglass Potential Use

GRE fiberglass piping has an abundance of potential uses due to its durability, chemical resistance, and relatively low costs. From its inception in the 1950's, fiberglass piping has been used extensively in oil and water production. In Texas, fiberglass piping has been used for hot brine transmission, brine injection, chemical disposal and geothermal applications. The state of Florida has allowed uses such as aquifer recharge injection, deep well applications, and public water supply. Florida, Nebraska and

Arkansas regulations specifically address fiberglass for use in public water supply applications as well (Appendix B).

Fiberglass Advantages and Disadvantages

Utilized in water well applications, fiberglass has a number of advantages over carbon steel, stainless steel and PVC casing. Favorable cost and superior corrosion resistance are the primary benefits when choosing fiberglass over other common casing materials, however, ease of installation and material weight are additional benefits that a potential user may consider. A comparison between fiberglass and HSLA pipe is not provided, because of the variability of composition of HSLA and its limited use in Texas public supply wells.

Fiberglass vs. PVC

The principal advantages of GRE fiberglass over PVC are:

- Superior strength at deeper settings and larger casing diameters
- Superior durability during transport and installation
- Less susceptible to abrasion from pumping equipment vibration
- Superior resistance to heat

The principal disadvantages of GRE fiberglass over PVC are:

- Higher cost
- Availability
- Ease and time required for permitting

Fiberglass vs. Carbon Steel

The principal advantages of GRE fiberglass over carbon steel are:

- Highly superior corrosion resistance (Appendix C)
- Typically faster and easier installation
- More stable pricing

The principal disadvantages of GRE fiberglass over carbon steel are:

- Higher cost
- Availability
- Ease and time required for permitting
- Requires specialized handling
- Partial loss of strength due to heat
- Significantly less resistance to hydraulic collapse

Fiberglass vs. Stainless Steel

The principal advantages of GRE fiberglass over stainless steel are:

- Lower cost
- Superior corrosion resistance (Appendix C)
- Typically faster and easier installation
- More stable pricing

The principal disadvantages of GRE fiberglass over stainless steel are:

- Availability
- Ease and time required for permitting
- Requires specialized handling
- Partial loss of strength due to heat
- Significantly less resistance to hydraulic collapse

Further information on these advantages and disadvantage is detailed in the case study provided in this guidance manual.

Fiberglass Certifications

NOV GreenThread fiberglass is designed and constructed based on the ASTM D2996, D4024, D5685, and D2925 standard specifications. The pipe is tested based on ASTM D2992, D1599, D2105, and D2412 standard test methods (Table 4). The casing, fittings, couplings, and joining and sealing materials used in NOV fiberglass systems have been approved for drinking water applications and are in compliance with NSF/ANSI Standard 61. The general specifications and certifications for GreenThread pipe can be found in Appendices D & E. For NSF 61 standards publications please visit www.nsf.org.

Table 4. ASTM Standards Description	
ASTM Standard	Description
D2996	Specification for Filament-Wound Fiberglass (Glass-Fiber-Reinforced Thermosetting-Resin) Pipe
D4024	Specification for Machine Made Fiberglass (Glass-Fiber-Reinforced Thermosetting Resin) Flanges
D5685	Standard Specification for "Fiberglass" (Glass-Fiber-Reinforced Thermosetting-Resin) Pressure Pipe Fittings
D2925	Standard Test Method for Beam Deflection of "Fiberglass" (Glass-Fiber-Reinforced Thermosetting Resin) Pipe Under Full Bore Flow
D2992	Practice for Obtaining Hydrostatic or Pressure Design Basis for Fiberglass (Glass-Fiber-Reinforced Thermosetting-Resin) Pipe and Fittings
D1599	Test Method for Resistance to Short-Time Hydraulic Pressure of Plastic Pipe, Tubing, and Fittings
D2105	Standard Test Method for Longitudinal Tensile Properties of "Fiberglass" (Glass-Fiber-Reinforced Thermosetting-Resin) Pipe and Tube
D2412	Standard Test Method for Determination of External Loading Characteristics of Plastic Pipe by Parallel-Plate Loading

Existing Uses of GreenThread

Fiberglass pipe has been used nationwide in oil, chemical, and water transmission systems. A list of past and current applications indicates the versatility of this material.

- Sludge transport
- Wastewater transport
- Hot and cold water transport
- Industrial acid waste transport
- Firewater transport
- Underground fuel lines
- Oil and gas applications including:
 - Water injection and disposal
 - Gas production and gathering
 - Battery transfer lines
- Marine/offshore applications including:
 - Fire water mains
 - Cooling water
 - Ballast systems

Selection of Casing Material

The following sections describe the engineering calculations and water chemistry considerations used in the selection of well casing. Resistance to hydraulic collapse pressure (RHCP) during cement grouting operations and water quality are the primary considerations used to narrow casing material options. The design phase provides an opportunity to evaluate strengths and properties of the casing under site-specific conditions.

Corrosiveness can be an imprecise evaluation because of the complex chemical reactions. It is often useful to evaluate the physical properties of the casing for its suitability to the application prior to conducting studies of the materials' suitability for the water quality. The main physical forces imposed on casing during well installation are horizontal and tensile loading. Of these physical forces, horizontal loading during cementing operations is typically the most limiting to the selection of casing material. While it is recommended that tensile loads be calculated, it is uncommon for it to be a significant limiting factor.

Horizontal and tensile loads are only critical during well construction due to the dynamic conditions encountered when setting and cementing the casing.

Resistance to Hydraulic Collapse Pressure

Resistance to hydraulic collapse (RHCP) is the casing's ability to resist external pressures that result from differential fluid densities during cementing operations. Collapse strength for a specific casing is determined by wall thickness, diameter, and structural properties of the material (Yield strength, Young's modulus and Poisson's ratio). Casing wall thickness and diameter are the two controllable design parameters that are most critical.

During emplacement of cement grout in the annulus, an AWWA-approved cement is pumped from the bottom of the casing until it appears at the surface on the exterior of the well. In telescoping under-reamed well designs (Figures 5 and 6), tubing is installed to the base of the casing, the inside of the casing is filled completely with drilling mud or clear water and the top of the casing is sealed at the surface. During the cementing process shown on Figure 5 (AWWA Standard 100-06, Appendix C.6) the fluid column on the outside of the casing (cement grout) is isolated from the fluid on the inside of the casing (water or drilling mud) with a float shoe. A float shoe is a valve that only allows fluid to flow in one direction. Because the cement on the outside of the casing is heavier than the mud/water in the inside of the casing, external pressure on the casing is created. The fluid pressure differential is greatest at the bottom of the casing and must not exceed the RHCP rating of the casing. Down hole pressure inside and outside of the casing is calculated as:

$$P_i = \delta \cdot H / 144 \text{ (eq. 1)}$$

Where:

P_i = Internal Pressure, in pounds per square inch (psi)

δ_i = Internal Fluid Density, in pounds per cubic foot

H = Height of water/mud column, in feet

$$P_e = \delta \cdot H / 144 \text{ (eq. 2)}$$

Where:

P_e = External Pressure, in pounds per square inch (psi)

δ_e = External Fluid Density, in pounds per cubic foot

H = Height of cement column, in feet

$$\Delta = P_e - P_i \text{ (eq. 3)}$$

Where:

Δ = Pressure differential on casing exterior at the bottom of the well, in psi

Figure 5

Well Schematic: Float Shoe

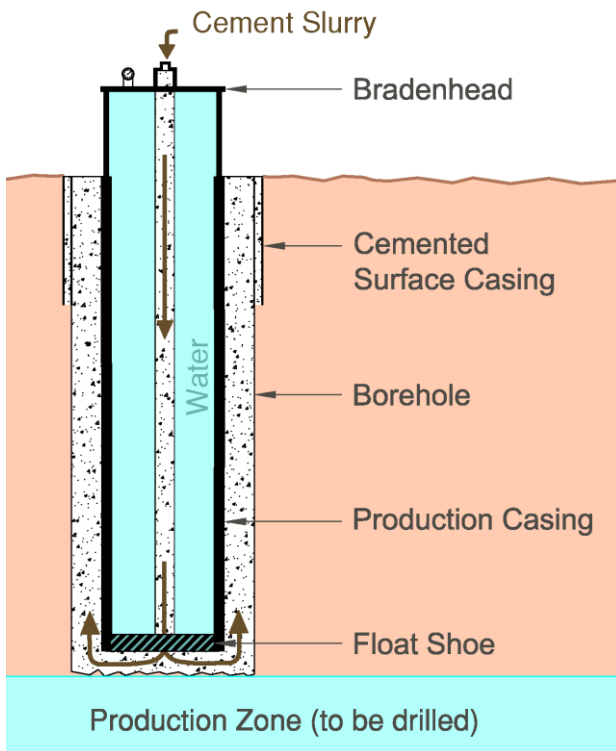
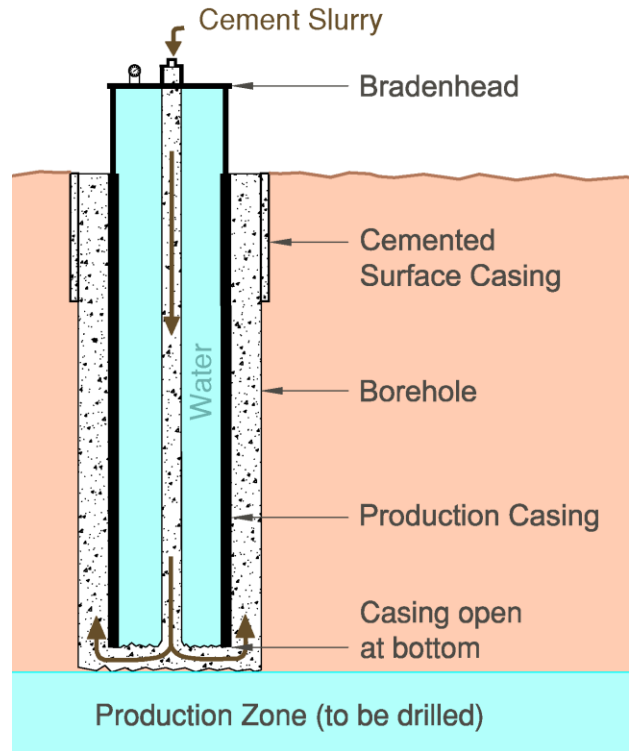

Figure 6

Well Schematic: Open Telescoping



The cementing process shown on Figure 6 (AWWA Standard 100-06, Appendix C.4) is identical to the process described for Figure 5 with the exception of the float shoe. In figure 6, the bottom of the casing is open to the annulus without the benefit of a valve that prevents fluid from flowing back into the casing. The risk in cementing using this method is that if the seal between the cement tremie line and the bradenhead is compromised, the heavier cement on the outside of the casing will displace the water on the inside of the casing – which would be leaking out the compromised seal – and the cement will set up on the inside of the casing and the annular seal will not extend the entire length of casing. The advantages of using this method is the fluid pressures inside and outside the casing are roughly equal at the bottom of the casing, and there is an outward pressure at the top of the casing. Burst pressure ratings for well casing is typically greater than collapse pressure ratings and is generally not a concern in shallow applications. The cementing process shown on Figure 6 is only recommended for relatively shallow casings where there is certainty that the outward pressure can be adequately contained by the seal between the cement tremie line and the bradenhead.

In straight wall designs (Figure 7), equation 3 is also used to calculate the external pressure on the casing. It is important to note that the top of the well is not sealed and the fluid column height inside the casing may not extend to the surface. This is especially critical when using PVC casing because there may not be an internal fluid inside the casing to provide outward pressure and to dissipate the heat generated during cement curing. Adding water or weighted fluids to fill the casing can help add internal pressure and dissipate heat. However, because the mud/water on the inside of the casing is open to the formation - through the screen - fluid losses may be expected. Therefore, it is critical that the internal fluid levels are maintained until the cement has cured. Fluid loss to the formation may make well development more difficult. When cementing straight wall wells, a tremie pipe is placed very near the top of the gravel pack and pumped from the surface (AWWA Standard 100-06, Appendix C.3). The cement surrounds the casing and displaces the fluid until cement appears at the surface (Figure 7).

The result obtained from equation 3 is then compared to the published or calculated RHCP for the intended casing. Calculating RHCP for fiberglass and PVC casing is more difficult than steel because the manufacturers use proprietary formulations of their product that make it difficult or impossible to verify their RHCP rating. Carbon and stainless steel are standard formulations and yield strength, Young's modulus, and Poisson's ratio are known values. If a custom wall thickness pipe will be considered, then working with the fiberglass manufacturer at this stage in the design process is important.

Figure 7
Well
Schematic:
Straight
wall

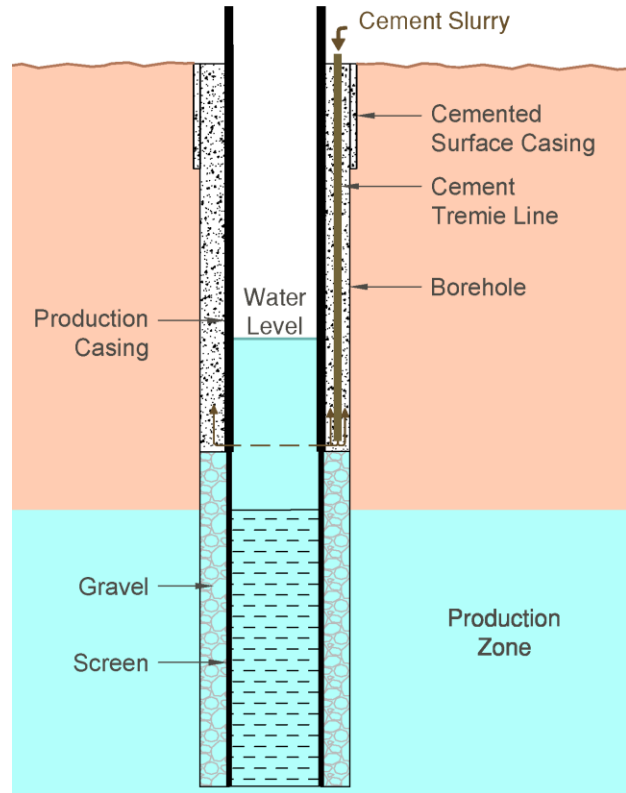

Table 5 shows sample pressures and pressure differential on a casing at various cement well depths. It is important to note that the fluid densities may be different depending on the grout mixture and internal fluid density. Flexible bentonite grouts are not permitted on public supply wells under current TCEQ rules.

Table 5. Pressure on Base of Well Casing Exerted During Cementing Process

Density of Cement (lbs/ft ³)	Height of Cement Outside Casing (ft)	Density of Water (lbs/ft ³)	Height of Water Inside Casing (ft)	Pressure Differential at Casing Base (psi)
101*	100	62.4	0	70
101*	100	62.4	100	27
101*	200	62.4	200	53
101*	500	62.4	500	134
101*	1000	62.4	1000	268
101*	1500	62.4	1500	402
101*	2000	62.4	2000	536
117**	2000	62.4	2000	758

*Portland Cement with 6% Bentonite

**Portland Cement with 0% Bentonite

A direct comparison between RHCP values for the casing materials discussed in the guidance manual cannot be made because collapse pressure for steel is calculated from the physical properties of the steel, while fiberglass and PVC RHCP values are provided by the manufacturer and include a safety factor. The engineer must decide on an appropriate safety factor for steel casing. For carbon steel, stainless steel, and PVC, RHCP ratings increase with larger wall thicknesses and smaller diameters. For fiberglass, wall thickness has a greater effect on RHCP rating than diameter, because of the internal structure (fibers) and angle at which the fibers are wrapped.

Tensile Strength

During well construction, the casing – or casing and screen in straight wall wells - is suspended in the borehole as each casing piece is joined to the next. Gravity exerts a tensile load over the length of the casing, and is greatest at the surface. Typically, the borehole is filled with water or drilling mud, therefore the casing material has buoyancy that will counterbalance the weight of the casing string. The tensile load is the difference between the weight of the casing and its buoyancy given by equation 4:

$$T = [L_t * w] - [((D_o/2)^2 * \pi) - ((D_i/2)^2 * \pi) * L_s * d] / [((D_o/2)^2 * \pi) - ((D_i/2)^2 * \pi) * 144] \text{ eq. 4}$$

Where:

- T = Tensile load (psi)*
- L_t = Total Length of casing(feet)*
- L_s = Submerged Length of casing(feet)*
- D_o = Outside diameter of Casing (feet)*
- D_i = Inside diameter of Casing (feet)*
- w = casing weight (lbs per foot)*
- d = borehole fluid density (lbs/ft³)*

Tensile strength of steel, PVC and fiberglass casing and couplings is obtained from the manufacturer. Tensile strength is generally not a significant design limitation, except in deep wells (greater than 1,000 feet). Table 6 lists the tensile strength of the casing materials discussed in this report.

Table 6. Tensile Strength of Casing Materials	
Casing Material	Tensile Strength (psi)
Grade 1/Grade 3 Carbon Steel	48,000/60,000 ¹
304/316 Stainless Steel	75,000/75,000 ²
PVC	7,450 ³
Fiberglass	10,550 ⁴

¹ ASTM Standard A53

³ ASTM Test Method D638

² ASTM Standard A333

⁴ NOV GreenThread 250 Product Data Sheet

*May vary based on manufacturer's formulation

Corrosion in Water Wells

Metal ores are found throughout nature but are not present in a form that can be directly usable in the components of a groundwater supply system. Well casings, pumping equipment, pipelines, etc. must be fabricated by processing raw metal ore into elemental metals. However, most elemental metals are not inherently stable in the environment and try to revert into more stable forms. This reverse conversion process is known as corrosion and occurs through both chemical and electrochemical processes. A comprehensive discussion of the causes and effects of corrosion on various materials is beyond the scope of this manual; however, corrosion of well materials is the subject of numerous texts such as the *AWWA Evaluation and Restoration of Water Supply Wells* (1993) and *Groundwater and Wells* (2007), which provide more comprehensive discussions on the topic.

Identifying the Potential for Corrosion

Use of plain carbon steel for well construction materials is widespread in the industry. In many cases, plain carbon steel provides the best cost/benefit considering material strength, operating conditions, and life of the material. In other cases, corrosion is severe and unsatisfactory life is experienced. To address this, the native groundwater quality must be considered to select the well construction material best suited for both the corrosion potential (material life) and required design strength.

Water Quality Considerations

Groundwater quality can be an indicator of the potential for corrosion of well casing. Some of the more important parameters include pH, chloride, total dissolved solids, and dissolved gases. Table 7 lists these indicators and their particular concern relative to corrosion.

Table 7. Common Corrosion Related Constituents in Texas Groundwater	
Indicator	Remarks
pH	A measure of the concentration of hydrogen ions in water. Indicates whether water is acidic or basic. Acidic water (pH<7) is generally considered to be corrosive
Total Dissolved Solids (TDS)	TDS is a general indicator of the concentration of dissolved ions that may contribute to corrosion
Dissolved Oxygen (DO)	In general, greater concentrations of dissolved oxygen indicate increased corrosiveness of groundwater
Sulfide (S ⁻²)	Highly corrosive if present as hydrogen sulfide ¹
Carbon Dioxide (CO ²)	Carbon dioxide reacts with water to form carbonic acid, which increases groundwater acidity and corrosivity
Chloride (Cl)	Corrosive in concentrations greater than 200 mg/L ²

¹ Hem, 1992

² Groundwater and Wells, 2007

Groundwater with a pH of 7.0 is considered to be neutral, while a pH below 7 is considered acidic and a pH above 7 is considered to be alkaline or basic. In general, acidic groundwater accelerates corrosion, while alkaline waters will tend to promote the precipitation of solids thereby providing protection against corrosion. The pH that corrosion will occur is related to both the chloride content of the water and the temperature. In general, there is a greater probability of corrosion under higher the temperature and chloride concentration, and lower pH environments. A pH of less than 4 is highly corrosive, but even groundwater with pH above 7 can be corrosive.

Gases such as oxygen, carbon dioxide, and hydrogen sulfide may be dissolved into groundwater and can increase the potential for corrosion. Oxygen and carbon dioxide (CO₂) enter groundwater through interaction with the atmosphere or through dissolution of formation materials through chemical processes. Hydrogen sulfide (H₂S) is formed when sulfate reduction

activity, usually in form of bacteria, occurs in groundwater stemming from interactions with petroleum or decaying organic matter.

Galvanic Corrosion

In addition to corrosion facilitated by groundwater quality, there are material compatibility considerations that can affect well life. When two adjacent metals of different compositions are placed in an electrolyte solution, an electric potential is created, incurring a current flow. Corrosion occurs as electrons are lost from the active metal (anode), which oxidizes and dissolves, releasing positive ions that travel through the electrolyte solution to a less reactive metal (cathode). Galvanic corrosion is dictated by the passive and active properties of two adjoining metal alloys (Groundwater and Wells, 2007). Carbon steel and iron are active metals and will readily corrode when in contact with a less reactive metal. Stainless-steel is an alloy that combines iron with other metals that are less reactive and will generally act as a cathode in the galvanic process.

Material Selection

The choice of material selection in well construction should consider the potential for corrosion, the service conditions, life expectancy, and economics. To address corrosion, there are several options:

- Use of protective coatings such as epoxy paint,
- Protective films produced on surfaces by chemical reactions,
- Application of electrical potential to equipment, or
- Selection of more corrosion resistant material.

Careful consideration of the operating environment desired service life and cost leads to the material best suited for its application.

Case Study - NAWSC Donna Project

The following sections provide a summary of the milestones achieved in the construction of a fiberglass-cased public supply well. While some of these milestones are routine for many groundwater supply projects, there were several challenges that needed to be overcome. The intent of this section is to highlight some of the differences and planning required to utilize a new well construction material. Where appropriate, a “lesson learned” note is provided.

Owner Involvement

The development of this project began with a request from the project owner, NAWSC, to identify ways to reduce the construction cost of developing a brackish groundwater project. The RO treatment plant project engineers, NRS Consulting Engineers, and the groundwater hydrologists/engineers, R.W. Harden and Associates, Inc. identified alternate well casing materials as a potential cost saving measure that had the potential to increase well life. Fiberglass was suggested as a strong candidate because of its strength and corrosion resistant properties. NOV Fiberglass Systems was chosen as a potential supplier of well casings based on their experience with oil field well casings, their involvement in supplying fiberglass pipe for the RO treatment plant, and their willingness to adapt an existing product for a new use.

Willingness of the owner to accept the risk for trying new methods and materials and manufacturer’s ability to provide testing data and design drawings for a re-purposed product proved to be a time-consuming process. Other manufacturers of fiberglass casing for water wells were not available in the diameter (24 inches) needed for the project. The immediate need for additional water supplies during a period of drought for an owner with a rapidly growing number of customers resulted in several projects that had short time schedules. Fiberglass casing had been considered for three other projects since 2004, but the project schedules did not allow sufficient time to work through the design issues. The time required to fully evaluate the casing and obtain TCEQ approval for its use were all significant obstacles in the implementation of the plan.

NRS Consulting Engineers, the lead design engineer for the project worked with the owner to anticipate future growth and initiate projects prior to immediate need was key to implementing the use of fiberglass casing. A brief relief from drought conditions coupled with the prior work that was conducted to investigate the use of fiberglass well casing allowed the project team to implement a schedule that was workable.

Lesson Learned:

The implementation of new well designs and construction materials requires a significant amount of time. Identifying long-term demands and prior planning were critical to providing an opportunity for the owner to explore the use of methods and materials that are more cost effective and are likely to provide a longer service life.

Preliminary Considerations

Fiberglass is an ideal product for use in brackish or corrosive water environments if water quality is the only consideration; it may not be the best casing material for all projects. Initially, casing material selection was explored based on the needs of the project. State-approved casing material, water quality, engineering limitations, NSF certification and budget were all considered prior to selection of casing material.

Based on aquifer evaluations of the project site, a preliminary engineering investigation of the well design was conducted to explore horizontal and vertical loads on the casing during installation and well use, and to verify with the manufacturer that the product could meet the basic strength requirements.

Cost and corrosion resistance were the principal arguments in favor of fiberglass casing over stainless steel casing. HSLA steel was considered but was likely to have an unacceptable service life for the project based on water quality. PVC was also considered, but uncertainty about its resistance to hydraulic collapse when using cement-based annular well grouts - due to unknown borehole temperatures resulting from the heat of hydration during cement curing - at the depths required resulted in an unacceptable risk for the owner. Fiberglass casing provided an acceptable balance between the high cost of stainless steel, the high potential for corrosion with HSLA steel, and the high risk of PVC casing collapse.

The principal challenge was to identify a product that met the engineering requirements of the project. The most significant were resistance to hydraulic collapse and indentifying a method to join each joint of casing in a reasonable period of time. Joining of fiberglass pipe typically involves application of epoxy resins that must be fully cured prior to submergence, and could take up to one hour per casing joint connection. This is particularly a concern in unconsolidated geologic formations where borehole stability is marginal and installation of casing and cement are time-critical.

The process for evaluating each casing material is provided in the previous section of this guidance manual. To address concerns about hydraulic collapse and developing a coupling system involved a number of conversations and communication with the manufacturer. Ultimately, the pipe used was custom manufactured for this application and tested to provide evidence that the resistance to hydraulic collapse was acceptable. Appendix F is a certification from the manufacturer that the well casing will meet the project requirements. Appendix G is engineering drawings of the coupling developed to join the casing. The coupling system includes adapters that are joined to the casing at the manufacturing plant, a coupling to join the adapters, a rubber gasket to ensure a water-tight seal, and a flexible spline that fits into opposing grooves in both the coupling and adaptor.

Selection of Material Supplier

Potential suppliers were identified through web searches and phone conversations with fiberglass pipe suppliers and drilling companies in other states to identify potential suppliers. Because no purpose-specific, 24-inch diameter, fiberglass casing was available, it was immensely helpful to identify a manufacturer (NOV Fiberglass Systems), who was willing to modify their existing products to meet the needs of this project. Twenty-four inch, NSF certified pipe was a product that was already manufactured, but designing a field coupling method that could be uncoupled and re-coupled – in the event the casing got stuck in the hole – without having to return the casing to the manufacturing plant to be refitted with new couplings was a time consuming process. Therefore, the principal challenge was to identify a method to join the pipe in an amount of time that would not risk borehole integrity and could be disassembled and rejoined in a short period of time, if needed.

Numerous meetings and phone conversations were held to identify the issues and develop a coupling that the manufacturer had the ability to fabricate and met the project requirements. NOV Fiberglass Systems expressed a willingness to work with the project engineers to develop a product that could be used in a water well application.

Preliminary Regulatory Meetings

Initial inquiries with TCEQ regarding the use of fiberglass casing yielded conflicting answers to the question of whether or not an exception would be considered. At issue was the absence of an AWWA standard for fiberglass casing and that TCEQ policy was to only allow casing which had an AWWA standard in public supply wells. These initial phone conversations occurred in the first few years after fiberglass was identified as a potentially beneficial product for brackish groundwater wells. Years later, when a project that had a workable timeline was identified, a face-to-face meeting with TCEQ staff was conducted to explain the project and potential benefits. TCEQ staff members were attentive, asked many questions and agreed to consider an exception.

An exception submittal was prepared that detailed the engineering calculations, NSF certifications, and general product information. The level of information required by TCEQ was significantly more than was originally anticipated. However, none of the information requests were unreasonable and a face-to-face meeting allowing senior staff to ask questions and listen to the proposal was a major milestone in reaching an understanding of the project. Initially TCEQ estimated that the exception review process would take 180 days. Actual approval was granted in about 100 days.

Selection of Casing Materials

The methods described in this guidance manual were used to evaluate the project design needs and the casing used. Because this project required two wells, it offered an opportunity to conduct a direct comparison between two wells with similar dimensions, one with stainless steel casing

and one with fiberglass casing. There were six principal considerations in the evaluation of the fiberglass casing:

- corrosion resistance,
- resistance to hydraulic collapse,
- attaching a well head flange at the top of the casing,
- casing diameter,
- developing a way to join the casing in the field, and
- reducing the amount of cement grout that remains in the casing after cementing is complete.

The following sections describe each of these considerations and how each was addressed.

Corrosion Resistance

Water samples taken from two test wells at the site indicated a total dissolved solid concentration of about 4,500 mg/L. The high salt concentration limited the production casing to materials having high corrosion resistance. It is widely known that PVC and fiberglass are nonreactive in salt solutions having a pH that is close to neutral.

Fiberglass and stainless steel were both proposed as possible well casing materials due to their corrosion resistance and applicability to the site specific conditions. PVC was also considered, but rejected because, at the time, it was not available in the size needed for the project, its collapse strength properties were not likely to be sufficient for the 240 foot depth setting required, and it is not a preferred material for telescoping well designs due to the risk of casing damage when re-entering the hole to drill the production zone. Carbon steel was not considered due to its low corrosion resistance. Stainless steel was an obvious choice as a standard material and was used in one well. Fiberglass was chosen as the material for the second well as the risks involved in using this new material could be mitigated and were outweighed by potential cost savings.

Resistance to Hydraulic Collapse

Using the standard float shoe method of cementing, it was determined that an external force at the bottom of the casing would be 65 pounds per square inch (psi). Published literature for the Green Thread 250 pipe indicates an ultimate collapse pressure of 175 psi and a rated collapse pressure of 55 psi. The rated collapse pressure includes a very conservative safety factor of 3.0 (Appendix A). These collapse pressure ratings are calculated based on the properties of the pipe. NOV Fiberglass Systems conducted laboratory testing of the casing and was able to provide a collapse pressure rating of 79 psi (Appendix F). Due to uncertainty about down hole temperature during cement curing and its affect on the rated collapse pressure, it was decided to avoid the collapse pressure issue and cement the well without a float shoe using AWWA A100-06 standard C.4. In this method, the cement and interior fluid columns are connected and the down hole pressure on both sides of the casing are equal. However, an internal pressure is created at the top

of casing which requires that the seal between the cement tremie pipe and the bradenhead be flawless. The contractor, Alsay Inc., confirmed that they were able to provide such a seal. The internal pressure rating of the casing is 250 psi which is more than three times the expected internal pressure at the bradenhead. A pressure gauge was installed on the bradenhead to monitor internal casing pressure.

Well Head Flange

The manufacturer designed and constructed a well head flange at the top of the upper casing joint that was capable of supporting the weight of the motor, column pipe full of water, pump and pump drive shaft. The flange was pre-drilled with bolt holes to attach the flanged well head sealing plate. A rubber gasket was installed between the flanges to form a water tight seal as required by TCEQ regulations.

Casing Diameter

Typically, casing diameter is selected based on well productivity and the size of the pump that needs to be installed. After the casing is installed and cemented, the screened interval is under-reamed to a diameter that is larger than the casing. Because the aquifer production zone is composed of unconsolidated gravel, cobbles and sand, drilling contractors have been hesitant to use an under-reamer for fear that it will not close after drilling if a piece of gravel gets lodged in the arms of the under-reamer, thereby preventing the under-reamer from being recovered from the hole. Because the top of production zone was relatively shallow (240 feet), an alternative telescoping well design was considered where the production zone is reamed using a standard drill bit. With a 24-inch casing (23.25-inch inner diameter for stainless steel pipe), the screened interval could be reamed to 22-inches with a standard drill bit and easily removed from the hole. Fiberglass casing would present a challenge for under-reamed holes because the under-reaming bit is typically closed by pulling – sometimes banging - up on the bottom of the casing. This is not an issue for steel casing, but it may be possible to damage fiberglass casing if the drilling contractor has difficulty closing the under-reamer.

Fiberglass Couplings

Couplings for the fiberglass casing were manufactured specifically for this application and manufactured with necessary dimensions to fit over the casing and with ample strengths to withstand loads exerted by the suspended casing string. Appendix G shows dimensions, in millimeters, for the coupling system of a 24''GreedThread 250 casing. The outside diameter of the joining coupling is about 29.5 inches, which is about 4 inches larger than the outside diameter of the casing.

To attach the coupling on each end of the casing, and to ensure a seal, a joining system was designed. The custom coupling system consists of two fiberglass adapter sleeves bonded to each end of a pipe joint, then joined end to end by the coupling. Joining and sealing adhesive is applied to the mating surfaces before the adapters are installed. During casing installation, the

coupling slides over an O-ring on each adapter and a key, or spline, is fed through a circular groove between the adapter and coupling.

It was necessary for each component of the coupling system to have ample strength to comply with collapse and tensile requirements as well as form a watertight seal to prevent cement from leaking into the casing. Strength of the system depends on the adhesive bond shear strength, key shear strength and joint strength. For bonded adapters, joint strength is based on the bond area and adhesive strength applied at the manufacturing plant.

Table 8 lists engineering specifications for the 24” fiberglass casing adapters and couplings. Cross sectional area and shear strength of key material was used to calculate keyed coupling tensile strength. Because the casing was cemented in place, loads on the casing and couplings are short term and are only applied when the cement grout is in a liquid state.

Table 8. Strength of GreenThread 250 Coupling System	
Bonded Adapter	
Casing Diameter (in)	24
Bond Length (in)	10.6
Allowable Short Term Shear Strength (psi)	500
Allowable Short Term Joint Strength (lbs)	417,304
Keyed Coupling	
Casing Diameter (in)	24
Shear Plane Diameter (in)	27.165
Key Diameter (in)	0.591
Shear Area (in)	50.4
Allowable Short Term Key Shear Strength (psi)	4,800
Allowable Short Term Joint Strength (lbs)	241,915

If fiberglass casing is to be used in straight wall applications, a method for attaching the casing to a stainless steel, wire-wrapped screen must be developed. Although this design was not considered for this project and not thoroughly investigated, possible options include: 1) fabrication of a stainless steel adapter that mates to the fiberglass coupling described above, 2) sending the upper joint of stainless steel screen to the fiberglass manufacturer so that it can be bonded at the fiberglass plant using a wrapped joint, and 3) use of mill-slotted fiberglass screen. All of these methods require that the exact setting depth of the screen and casing be known prior to construction. Mill-slotted screens are not preferred in large capacity public supply wells, due to their smaller amount of open area and potential for constructing low-efficiency wells.

Reducing Amount of Cement in the Casing

Because there is typically a few to several feet of cement remaining in the bottom of well casings which must be drilled out, there was concern that drilling out this remaining cement would damage the bottom of the casing. In an effort to mitigate this concern, the cement tremie line was installed to the same depth as the casing, and the casing was completely filled with water prior to sealing the bradenhead. A slug of fresh water that was the exact volume of the tremie pipe and cement hoses followed the cement after a cement return appeared at the surface on the outside of the casing.

Regulatory Submittals and Approval for Use

Fiberglass is currently not permitted as a well casing material in Texas. Texas Administrative Code (TAC) does not allow for casing material other than those approved by the AWWA standards (TAC Title 30, Chapter 290.41(c)(3)(B)). The following items were submitted in support of the exception request:

- Well Specifications
- Design drawings of the well
- Manufacturer information on the engineering properties of the casing
- NSF certifications for the casing and couplings
- Calculations showing the tensile and collapse forces exerted on the casing
- Florida and Nebraska Regulations concerning fiberglass casing in public supply wells

Appendix H includes the exception request letter submitted to the TCEQ by RWH&A and TCEQ's approval letter.

Cost Evaluation

Designing both wells concurrently allowed RWH&A to compare prices of stainless steel and fiberglass in nearly identical well designs at a single point in time, and having a nominal casing length of 247 feet. Table 9 shows the prices for stainless steel and fiberglass received in two contractor bids.

Lesson Learned:

Early communication, including a face-to-face meeting with TCEQ staff is critical during the planning phase. Alternative construction methods were required to properly address construction risks using fiberglass casing rather than stainless steel.

Table 9. Sample Casing Material Cost Comparison		
	304 Stainless Steel	Fiberglass GreenThread 250
Contractor #1 - Well Cost	\$507,228	\$433,570
Contractor #2 - Well Cost	\$533,630	\$455,933
Contractor #1 Cost per foot difference (Stainless Steel vs. Fiberglass)	\$298	
Contractor #2 Cost per foot difference (Stainless Steel vs. Fiberglass)	\$315	

Construction

Material Delivery Time

Depending on manufacturer and casing dimensions, delivery times for fiberglass casing can vary anywhere from a few days to months. Fiberglass casings less than 16” are typically in-stock product for at least one manufacturer. Because the 24” casing used for this project had to be made custom to the specific applications, a significant amount of time was needed for delivery.

Because test drilling had been conducted at the site prior to well design, the amount of casing material was known in advance (Appendix I). The manufacturer had advised the project team that the delivery time for the 24” casing would be 12-16 weeks; therefore, materials were ordered upon award of the work, and the project proceeded with the construction of the stainless steel cased well first. Actual delivery time of the casing was about 16 weeks.

Initial Inspection

The fiberglass casing was inspected upon arrival at the contractor’s storage facility to observe any possible manufacturing flaws

and to ensure proper dimensions. The casing was re-inspected after it was unloaded at the job site to be sure no damage was incurred during transport.

Due to the brittle nature of fiberglass (as compared to steel), structural integrity may be compromised if the casing is dropped or mishandled. Generally, care must be taken when handling and installing the fiberglass casing. Part of the casing inspection included verification that the wall thickness and roundness of the pipe are within manufacturer’s specification.

Roundness inspection was the same procedure as steel casing; inner diameter calipers are used to measure the casing at 90 degree intervals and compared to specification. Measuring wall thickness presented a challenge because available wall thickness calipers do not have a deep enough throat to span the adapters at each end of the pipe.

An average inside diameter was determined from the roundness inspection. A PI Tape™ was used to measure the outside circumference of the pipe to the nearest 1/100th of an inch and outside diameter was calculated by dividing the circumference by π . The difference is the average wall

thickness. While this method is not as precise as using a wall thickness caliper, it was the only practical solution.

Inspection of fiberglass casing is not as straight forward as inspection of steel casing. Physical damage from mishandling is probably easier to identify, and the elastic properties of fiberglass make it more resistant to becoming out-of round, or “egging,” than steel casings if dropped. Measuring wall thickness required the use of non-standard measuring equipment and the measurements obtained are more of an average wall thickness as opposed to a specific point measurement.

Casing Joints

Casing length was measured to ensure that it would be placed at the proper depth. One joint of casing was not cut to length by the manufacturer to allow for final adjustments to the casing length based on the specific depth required for the well boring.

Casing was shortened by the contractor by making a straight cut using a circular saw, the edges and any imperfections were filed and a manufacturer-provided epoxy resin and hardener was applied to the cut end to ensure that the end of the casing would not fray.



Cutting fiberglass casing
Photo courtesy of Alsay, Inc.



Application of epoxy resin
Photo courtesy of Alsay, Inc.

Lesson Learned:

Custom Casing elevators may be required to lift casing.

Elevators

Two hinged elevators were used to lift and hold the casing during construction. Because lifting lugs are not typically installed on fiberglass casing, a hinged elevator must be used to lift and hold the casing string while the next joint is installed.

Custom-made elevators may be required to handle the casing during installation because the nominal outside diameter of fiberglass casing is different than steel pipe and the drilling contractor's existing casing elevators may not work.

Coupling Installation

Adapter sleeves were fitted on each end of the casing joint by the manufacturer. Couplings were installed on one end of each casing joint and the casing lowered into the boring with the coupling side facing upward. The coupling is attached to the adapter sleeve with a rubber o-ring and a spline which is inserted into a hole in the casing and pushed through a mated groove in the coupling and adapter sleeve. The next joint of casing was lifted onto the drill rig platform and then the lower end adapter was lubricated with a NSF certified pipe joint lubricant for ease of installation. The o-ring was installed on the proper groove, the upper joint was lowered into the upward facing coupling, and the spline slid into the circular groove between the coupling and adapter.

NOV Fiberglass Systems provided an engineer on-site during casing installation and cementing. During the casing installation process clear communication was established between the contractor and



Spline installation
Photo courtesy of RWH & Associates, Inc.



Casing installation
Photo courtesy of RWH & Associates, Inc.

manufacturer's representative. The engineer observed all parts of the installation process, checking for compliance with well construction and fiberglass material specifications.

Centralizers

Hinged centralizers were attached around the coupling to center the casing in the borehole.

Casing Cementing

Because fiberglass can be easily damaged by a drill bit, minimal cement encroachment inside the casing as a result of the pressure cementing process was necessary. If a significant height of cement set up within the casing, drilling this plug could cause damage to the casing.

Cement volumes were carefully calculated and the cement tremie was set as close to the bottom of the casing as possible and the cement was followed by a slug of water equal to the volume of the tremie pipe and cement hoses at the surface to ensure that no excess cement would be present in the bottom of the casing. Pressure on the bradenhead was monitored during cementing operation and no unexpected pressure developed.

During all cementing operations, the casing was hung in the boring to prevent buckling of the casing and assist with getting cement grout evenly distributed around the casing.

Production Zone Drilling

After the cement had cured and the bradenhead was removed, it was determined that less than one foot of cement remained in the bottom of the casing. The cement plug was carefully drilled and no significant amount of fiberglass appeared in the cement drill cuttings. The contractor, manufacturer



Centralizer installed around coupling
Photo courtesy of RWH & Associates, Inc.

and field inspector were in agreement that no significant damage to the casing was incurred.

Because the production zone was drilled using reverse circulation drilling, the gravel and sand removed from the boring were transported up the hole on the inside of the drill pipe. If normal circulation drilling methods are used with fiberglass casing, the engineer should consider whether damage to the casing may result from abrasion or mechanical erosion of the fiberglass as the formation materials are drilled from the production zone boring.

This page left intentionally blank

References

- American Water Works Association. 2006. AWWA Standard for Water Wells A100-06.
- Borch, M.A., Smith, S.A., and Noble, L.N. 1993. *Evaluation and Restoration of Water Supply Wells*.
- Burgess Well Company Inc., <http://www.burgesswell.com/comp.htm>, accessed September 2012.
- Hem, J.D. 1992. *Study and Interpretation of the Chemical Characteristics of Natural Water*, 3rd edition, USGS Water Supply Paper 2254.
- LBG Guyton Associates. 2003. *Brackish Groundwater Manual for Texas Regional Water Planning Groups*. <http://www.twdb.texas.gov/innovativewater/desal/projects.asp>
- NOV (National Oilwell Varco). *Case History*. <http://www.nov.com/folderDocs.aspx?id=13517>, accessed August 2011.
- NOV (National Oilwell Varco). *Green Thread*. http://www.nov.com/Industrial/Fiber_Glass_Pipe/Chemical-Industrial/Green_Thread.aspx, accessed August 2011.
- Sterrett, Robert. 2007. *Groundwater and Wells*.

This page left intentionally blank

Appendices

This page left intentionally blank

Appendix A: GreenThread Pipe Product Data

This page left intentionally blank

Green Thread® 250/250-C Product Data *(Marine/Offshore Piping Systems)*

Applications

- Firewater Systems
- Salt Water Supply Lines
- Cooling Water
- Waste Lines
- Potable Water
- Process Lines
- Ballast Piping
- Cargo Lines
- Bilge Piping
- Firefighting Foam
- Sprinkler Systems
- Fresh Water Lines
- Sanitary Lines
- Scuppers
- Sounding Tubes
- Vent Lines
- Drains
- Conduit

Characteristics

Green Thread 250

Filament wound Glassfiber Reinforced Epoxy (GRE) pipe.

Green Thread 250-C

Filament wound Glassfiber Reinforced Epoxy (GRE) pipe supplied with integral conductive carbon fibers.

Pipe Diameter: 25-900 mm (1-36 inch)

Maximum Operating Temperature: up to 110° C (230° F)

Maximum Operating Pressure: up to 18 bar (250 psig)

Pipe and fittings are manufactured as either non-conductive (Green Thread 250) or electrically conductive (Green Thread 250-C) versions.

Materials and Construction

Pipe

All pipe manufactured by filament winding process using an amine cured epoxy thermosetting resin to impregnate strands of continuous glass filaments.

All pipe supplied with square-cut ends for use with mechanical couplings or with positive-stop socket joint or matching tapered fittings.

Fittings and Flanges

Fittings and flanges are manufactured by filament winding process using amine epoxy resin. Standard flanges have ANSI B16.5 Class 150 bolt hole patterns, unless otherwise specified.

Conductive

A nominal 0.5 mm (0.020 in) thick liner reinforced with conductive veil, to prevent the accumulation of potentially incendive static charge buildup on Green Thread 250-C

Continuous conductive filaments are utilized throughout the pipe wall of Green Thread 250-C/250-CF at a predetermined pattern to prevent the accumulation of static charges and enable efficient grounding of charges through grounding saddles bonded to the pipe.

Fire Endurance

Green Thread 250 is fully qualified for IMO Resolution A.753(18) Level-3 fire resistance without any passive fire protection in 50-900 mm (2-36 in) sizes.

Joining Systems

Socket Joint

25-300 mm (1-12 in)

Positive pipe stop simplifies precise makeup of complex piping configurations



Bell & Spigot

350-900 mm (14-36 inch)

A matched-taper joint secured with epoxy adhesive.

Stronger than the pipe itself, in both internal-pressure and axial-tension capability.

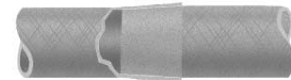

Fittings

Filament Wound - 25-900 mm (1-36 in)

Standard radius in 200-900 mm (8-36 in); Long radius 200-900 mm (8-36 in) fittings are available upon request.

Long radius (1.5 D) in 25-150 mm (1-6 in)

www.fiberglasssystems.com

P.O. Box 37389, 2425 SW 36th Street
San Antonio, Texas 78237 USA
Phone: 1 (201) 434-5043
Fax: 1 (210) 434-7543

NOV Fiber Glass Systems

Specifications

ASTM D2996 Designation Code

25-40 mm (1-1½ in); RTRP-11FF1-3111
 50-200 mm (2-8 in); RTRP-11FF1-3112
 250 mm (10 in); RTRP-11FF1-3114
 300-900 mm (12-36 in); RTRP-11FF1-3116

ISO 15840 Designation Code

25-150 mm (1-6 in) - Type 1, Resin 1, Class B, Rating Method 1, Fluid S, Fire Type IF, Fire Integrity B
 200-900 mm (8-36 in) - Type 1, Resin 1, Class B, Rating Method 1, Fluid S, Fire Type IF, Fire Integrity A

Type Approvals

- American Bureau of Shipping (ABS)
- Bureau Veritas
- China Classification Society (CCS)
- Det Norske Veritas (DNV)
- Germanischer Lloyd's
- Lloyd's Register
- United States Coast Guard (USCG)
- Korean Register of Shipping

Pipe Dimensions and Weights

Nominal Pipe Size		Nominal I.D.		Nominal O.D.		Nominal Wall Thickness		Nominal Weight	
in	(mm)	in	(mm)	in	(mm)	in	(mm)	lbs/ft	(kg/m)
1	25	1.00	25.0	1.33	34.0	0.16	4.2	0.4	0.59
1 ½	40	1.50	38.1	1.96	49.8	0.21	5.4	0.8	1.19
2	50	2.15	54.6	2.51	63.7	0.19	4.7	0.9	1.34
2½	65	2.72	69.1	3.11	79.0	0.19	4.8	1.2	1.79
3	80	3.28	83.3	3.66	93.0	0.19	4.8	1.4	2.08
4	100	4.28	108.7	4.66	118.4	0.19	4.8	1.8	2.68
5	125	5.20	132.1	5.73	144.9	0.23	5.8	2.5	3.73
6	150	6.35	161.3	6.80	172.7	0.23	5.8	3.1	4.61
8	200	8.36	212.3	8.95	227.3	0.30	7.6	5.3	7.89
10	250	10.36	263.1	11.06	280.9	0.35	8.9	7.8	11.61
12	300	12.28	311.9	13.09	332.5	0.41	10.4	10.7	15.92
14	350	14.04	356.6	14.94	379.5	0.46	11.7	13.7	20.39
16	400	16.04	407.4	17.07	433.6	0.52	13.2	17.6	26.19
18	450	17.83	452.8	18.96	481.6	0.57	14.5	21.5	32.00
20	500	19.83	503.6	21.08	535.4	0.62	15.7	26.3	39.14
24	600	23.84	605.5	25.31	642.9	0.74	18.8	37.5	55.81
26	650	25.59	650.0	27.03	686.5	0.72	18.3	52.0	77.55
28	700	27.56	700.0	29.05	737.9	0.75	18.9	58.0	86.49
30	750	29.53	750.0	31.12	790.5	0.80	20.2	66.0	98.42
32	800	31.50	800.0	33.20	843.3	0.85	21.7	75.0	111.85
36	900	35.43	900.0	37.34	948.5	0.96	24.3	95.0	141.67

Engineering Data

Nominal Pipe Size		NOV Fiber Glass Systems Pressure Rating		Vacuum/External Pressure @ Ambient Temperature ⁽¹⁾			
in	mm	Pressure Rating		Ultimate Collapse Pressure		Rated Pressure	
		psig	bar	psig	bar	psig	bar
1	25	250	18	>3000	>210	>1000	>70
1½	40	250	18	>3000	>210	>1000	>70
2	50	250	18	>1700	>117	>563	>38.8
2½	65	250	18	>1500	>100	500	34.5
3	80	250	18	855	59.0	210	14.5
4	100	250	18	305	21.0	96	6.6
5	125	250	18	380	26.2	55	3.8
6	150	250	18	175	12.1	55	3.8
8	200	250	18	175	12.1	55	3.8
10	250	250	18	175	12.1	55	3.8
12	300	250	18	175	12.1	55	3.8
14	350	250	18	175	12.1	55	3.8
16	400	250	18	175	12.1	55	3.8
18	450	250	18	175	12.1	55	3.8
20	500	250	18	175	12.1	55	3.8
24	600	250	18	175	12.1	55	3.8
26	650	250	18	150	10.3	50	3.4
28	700	250	18	150	10.3	50	3.4
30	750	250	18	150	10.3	50	3.4
32	800	250	18	150	10.3	50	3.4
36	900	250	18	150	10.3	50	3.4

⁽¹⁾ Long term rating incorporating the DEP Safety Factor of 3.0

Typical Physical Properties					
Property	Value (psi)		Value (MPa)		
	@ 75°F	@ 200°F	@ 24°C	@ 93°C	
Axial Tensile - ASTM D2105					
Ultimate Stress	10,550	7,680	71	52.9	
Design Stress	2,637	1,920	17.8	13.2	
Modulus of Elasticity	1.61 x 10 ⁶	1.16 x 10 ⁶	12411	7997	
Poisson's Ratio	0.38		0.38		
Axial Compression - ASTM D695					
Ultimate Stress	33,300	20,383	230.0	140.5	
Design Stress	8,300	5,090	57.4	35.1	
Modulus of Elasticity	1.26 x 10 ⁶	0.66 x 10 ⁶	8687	4550	
Beam Bending - ASTM D2925					
Ultimate Stress	23,000	17,166	159	118.3	
Design Stress ⁽¹⁾	2,900	2,145	20.0	14.8	
Modulus of Elasticity (long-term)	2.18 x 10 ⁶	1.29 x 10 ⁶	15031	8894	
Hydrostatic Burst - ASTM D1599					
Ultimate Hoop Tensile Stress	46,300	47,990	319	330	
Hydrostatic Design - ASTM D2992					
Procedure A - Hoop Tensile Stress					
Cyclic 150 x 10 ⁶ Cycles	LTHS	8,850	6,090	61.0	41.9
Procedure B - Hoop Tensile Stress					
Statio 20 Year Life at 200°F	LTHS LOL		16,945 14,654		116.8 101.0
Coefficient of Linear Thermal Expansion					
ASTM D696	1.26 x 10 ⁻⁵ in/in/°F		2.27 x 10 ⁻⁵ mm/mm/°C		
Thermal Conductivity					
	0.23 BTU/(ft)(hr)(°F)		0.4 W/(m)(°C)		
Specific Gravity - ASTM D792					
	1.8		1.8		
Flow Factor - SF					
Hazen-Williams Coefficient	150		150		

⁽¹⁾ Beam bending design stress is 1/8 of ultimate to account for combined stress (i.e. bending and pressure)

Maximum Support Spacing*					
Nominal Pipe Size		75° F (24° C)		200° F (93° C)	
in	(mm)	ft	(m)	ft	(m)
1	25	12.8	3.9	11.2	3.4
1½	40	15.2	4.6	13.3	4.1
2	50	16.2	5.0	14.2	4.3
2½	65	17.2	5.2	15.0	4.6
3	80	18.6	5.7	16.3	5.0
4	100	20.0	6.1	17.5	5.3
5	125	22.0	6.7	19.0	5.8
6	150	23.1	7.0	20.2	6.2
8	200	26.6	8.1	23.4	7.1
10	250	29.5	9.0	25.9	7.9
12	300	32.0	9.8	28.1	8.6
14	350	34.1	10.4	29.9	9.1
16	400	36.4	11.1	31.9	9.7
18	450	38.3	11.7	33.6	10.2
20	500	40.4	12.3	35.4	10.8
24	600	44.2	13.5	38.7	11.8
26	650	44.6	13.6	37.7	11.5
28	700	45.9	14.0	38.8	11.8
30	750	47.5	14.5	40.1	12.2
32	800	49.0	14.9	41.4	12.6
36	900	52.0	15.8	43.9	13.4

* Values are based on continuous (4 or more spans) beam equations.
For other span conditions, please refer to E5000 "Engineering Piping Design" or the "Success by Design" software available from NOV Fiber Glass Systems

Pipe Lengths

Nominal Pipe Size		Americas		Asia	
in	(mm)	ft	(m)	ft	(m)
1	25	13.0	4.0	13	4.0
1 ½ - 2	40 - 50	29.5	9.0	29.5	9.0
2 ½* - 4	65 - 100	19.3, 39.0	5.9, 11.9	32.8	10.0
5 - 12	125 - 300	19.3, 39.0	5.9, 11.9	39.0	11.9
14 - 16	350 - 400	19.3, 39.0	5.9, 11.9	28.2	8.6
18 - 24	450 - 600	19.3, 39.0	5.9, 11.9	25.5	7.8
26 - 36	650 - 900	19.3, 39.0	5.9, 11.9	39.0	11.9

* 2½ pipe in America only available in 32.8" (10m) random lengths

Properties of Pipe Sections*

Nominal Pipe Size		Minimum Cross Sectional Area		Minimum Moment of Inertia	
in	(mm)	in ²	(mm ²)	in ⁴	(mm ⁴ x 10 ⁹)
1	25	0.5	303	0.08	0.34
1½	40	0.9	592	0.34	1.41
2	50	1.0	666	0.7	2.93
2½	65	1.4	903	1.5	6.24
3	80	1.6	1052	2.5	10.2
4	100	2.1	1355	5.3	21.9
5	125	3.1	2000	11.3	47.0
6	150	3.7	2387	19.9	82.8
8	200	5.2	3368	48.2	201
10	250	7.6	4923	108	449
12	300	10.2	6581	203	845
14	350	13.1	8452	337	1400
16	400	16.7	10774	563	2340
18	450	20.3	13097	845	3520
20	500	24.8	16000	1276	5310
24	600	35.5	22903	2633	11000
26	650	52.0	33548	4476	18631
28	700	58.0	37419	5783	24071
30	750	66.0	42581	7596	31617
32	800	76.0	49032	9866	41065
36	900	95.0	61290	15720	65432

* Based on Minimum Reinforced Wall

National Oilwell Varco has produced this brochure for general information only, and it is not intended for design purposes. Although every effort has been made to maintain the accuracy and reliability of its contents, National Oilwell Varco in no way assumes responsibility for liability for any loss, damage or injury resulting from the use of information and data herein nor is any warranty expressed or implied. Always cross-reference the bulletin date with the most current version listed at the web site noted in this literature.

www.fiberglasssystems.com

P.O. Box 37389, 2425 SW 38th Street
San Antonio, Texas 78237 USA
Phone: 1 (201) 434-5043
Fax: 1 (210) 434-7543

NOV Fiber Glass Systems

© 2009, NATIONAL OILWELL VARCO
© Trademark of NATIONAL OILWELL VARCO
C3811 Issued July 2009 - Supersedes April 2008

Appendix B: Applicable Fiberglass Well Casing Regulations in Other States

This page left intentionally blank

Nebraska

Nebraska Health and Human Services Regulation and Licensure 178 NAC 12 Title 178 – Water Well Standards.

Chapter 12: Water Well Construction, Pump Installation, and Water Well Decommissioning Standards

12-003.04 Well Casing: All wells other than test holes and closed loop heat pump wells must be cased. Well casing must be composed of nontoxic durable material compatible with the water quality encountered.

12-003.04A Casing Wall Thickness: The wall thickness of water well casing must be sufficient to withstand the pressures exerted by the surrounding materials, forces imposed on it during installation, and corrosion by soil and water environments.

12-003.04B Casing Placement: The casing must be centered in the borehole in areas of grout so there is a minimum 2-inch uniform annular space.

12-003.04C Watertight Casing must be constructed of steel, PVC, fiberglass, or teflon. Plastic watertight casing must be made of virgin material and must be manufactured expressly for water well casing.

12-004.02C Non-steel watertight casing must be made of virgin material, must be manufactured expressly for well casing, and must meet the following specific requirements:

- (1). Casing strength must be not less than 160 pounds per square inch or Standard Dimension Ratio (SDR) 26.
- (2). Plastic or other non-steel casing must bear the National Sanitation Foundation (NSF) 61 stamp of approval.

12-004.02D Special Engineered (SE) plastic piping systems must meet the requirements of 178 NAC 12-004.02C item 2.

Florida

Water Well Permitting and Construction Requirements

62-532.500 Water Well Construction Standards.

(1)(a) Well casing, liner pipe, and well screen shall be new or in like new condition. Such well casing, liner pipe, or well screen shall not be used unless free of breaks, corrosion and dents, is straight and true, and not out of round. Welded or seamless black or galvanized steel pipe or casing, or stainless steel pipe or casing; or approved types of nonmetallic pipe shall be used for well casing or liner pipe. All well casing shall conform to one of the following standards: American Society for Testing and Materials (ASTM) A53/A53M-99b, A135-01, A252-98,

A589-96, or American Petroleum Institute (API) 5L-2000. Well casing that conforms to any of the aforementioned ASTM or API standards shall also conform to the American National Standard for Welded and Seamless Wrought Steel Pipe (ANSI/ASME B36.10M-2000). All well casing shall be stenciled with the applicable standard, or proper documentation of manufacturer specifications must be supplied to the permitting authority upon request.

(f) The Department shall approve a well casing or liner pipe not otherwise specified in Rule 62-532.500(1)(a) through (e), F.A.C., if the applicant makes a showing, certified by a professional engineer, to justify that such use would provide an equivalent material strength and durability. The following material has been approved pursuant to this procedure:

DNS Well-Cor, Allied Tube and Conduit, A Division of Grinnel Corporation, 1440 Massaro Boulevard, Tampa, Florida, 33619.

Nominal Size (in)	Outside Diameter (in)	Wall Thickness (in)
1.25	1.638	0.085
2	2.360	0.095
4	4.466	0.150

(g) Well casing, liner pipe, and well screens used for potable water well construction or repair shall conform to Section 6 of NSF International Standard 14-2001, Plastics Piping System Components and Related Materials, or NSF International Standard 61-2001, Drinking Water System Components – Health Effects, both of which are adopted and incorporated by reference herein.

Arkansas

Arkansas Water Well Construction Commission Rules and Regulations

V. Construction

5.4.8 Fiberglass casing. Fiberglass reinforced plastic well casing, tested in accordance with ASTM D1180 (American Society Testing Materials), may be used where judged desirable by the contractor and approved by the customer, in consolidated and unconsolidated formations. Each coupling shall form a watertight seal. Pipe having a minimum bursting pressure of 660 psi may be used.

6.7 Public and semi-public wells. Wells for public and semi-public water systems shall be located, designed, and constructed in accordance with the respective regulations of the Arkansas Department of Health (ADH) and shall have written approval from the ADH prior to the start of

construction. If uncertain that a well is public or semi-public, the well contractor shall obtain a written determination from the ADH prior to construction.

**Arkansas State Board of Health
Rules and Regulations Pertaining to Public Supply Systems**

VIII.B Well Construction

All public water wells, whether community or non-community, shall be constructed in accordance with the latest edition of AWWA Standard A100 and approved by the Arkansas Department of Health. A copy of the well construction log shall be filed with the Arkansas Department of Health.

1. Casing

Every well must have an outside water tight casing extending below the ground surface to such a depth as may be necessary, depending upon the character of the underground formations, to exclude the entrance of undesirable water and sub-surface contamination, as determined by the Arkansas Department of Health. The outer casing should be seated securely into an impervious formation whenever possible, otherwise the casing should extend as far as practical below the water table. The casing, when it extends into a pump room, shall project above the pump room floor, and safely above maximum flood elevation.

This page left intentionally blank

Appendix C: GreenThread Pipe Chemical Resistance

This page left intentionally blank

Chemical Resistance Guide

RED THREAD® II

GREEN THREAD®

Z-CORE®

CENTRICAST® RB-2530

CENTRICAST® RB-1520

CENTRICAST® CL-2030

CENTRICAST® CL-1520

F-CHEM®



www.fgspipe.com

2700 West 65th Street
Little Rock, Arkansas 72209
Phone: 1 (501) 568-4010

25 S. Main Street
Sand Springs, Oklahoma 74063
1 (918) 245-6651

NOV Fiber Glass Systems

Introduction

This guide is intended for use only as a reference in evaluating fiberglass pipe. It should be used for a general indication of chemical resistance. NOV Fiber Glass Systems data indicates that the pipe and fittings listed are suitable for the services as recommended. However, due to varying conditions encountered in usage from plant to plant, the data should be considered as a recommendation and not as a guarantee. NOV Fiber Glass Systems offers a limited warranty of its products, which is in the Terms and Conditions of Sale. This data does not take into account chemical mixtures, thermal-mechanical or associated loading or stress combinations. Accordingly, the end-user of the fiberglass products assumes the responsibility and risk for proper evaluation, selection, use, and performance of the products in its particular application.

Basis of Chemical Resistance Recommendations

The information contained in this literature is based on corrosion resistance testing, field experience, published information, and NOV Fiber Glass Systems engineering judgment. Corrosion resistance testing includes the pipe, fittings and adhesive used in NOV Fiber Glass Systems piping systems. There are many successful installations that form the basis of the field experience and engineering judgment recommendations. NOV Fiber Glass Systems products must be installed and used in accordance with proven practice and common sense. Corrosion barrier and total wall thickness may affect service life in aggressive chemical or abrasive applications.

Unlisted Applications and Combinations of Chemicals

NOV Fiber Glass Systems piping is being used in many applications containing other chemicals, solvents and combinations of chemicals not listed in this literature. These applications should be reviewed with the factory for evaluations of the chemicals, their concentrations, temperatures, frequency of use, and other factors that may determine our suitability to provide economic service life. Extra care should be taken when there are combinations of chemicals as some combinations may be more aggressive than their constituent parts. Trace amounts of some chemicals can affect the piping service life.

Custom Piping Systems

NOV Fiber Glass Systems can provide 1" through 72" filament wound and contact molded piping systems manufactured with resins specified by our customers. The resin manufacturers chemical recommendations should be followed when specifying custom piping.

Chemical	RED THREAD II	GREEN THREAD	Z-CORE	RB-2530 RB-1520	CL-2030 CL-1520	F-CHEM (9)(20)
Maximum Recommended Service Temperature °F						
Acetaldehyde	---	---	100	---	---	NR
Acetamide	NR	NR	100	---	---	---
Acetyl Chloride	NR	NR	100	---	---	NR
Acetic Acid, 10%	150	200	200	150(1)	150	210
Acetic Acid, 25%	NR	120	120	100	100	210
Acetic Acid, 50%	NR	120	120	100	100	180
Acetic Acid, 75%	NR	75	75	75	100	140
Acetic Acid, Glacial	NR	NR	NR	NR	NR	NR
Acetic Anhydride, 100%	NR	NR	100	NR	NR	NR
Acetone, 1%	150	150	200	150	150	150
Acetone, 10%	150	150	200	125	140	NR
Acetone, 100%	100	120	125	NR	NR	NR
Acetonitrile ACN	NR	NR	120	---	---	NR
Acrylic Acid, 25%	NR	120	120	NR	100	100(1)
Acrylic Acid, 95%	NR	100	100	NR	75	NR
Acrylonitrile, 100%	NR	NR	100	NR	NR	NR
Adipic Acid, Hexanedioic Acid	---	---	250	250	75	180
Air (Wet Or Dry)(6)	210	225	300	300	200	200
Allyl Alcohol	NR	NR	120	100	NR	NR(3)
Allyl Chloride	100	120	150	100	NR	NR
Alum, Sat'd	210	225	275	250	200	210
Aluminum Chloride, 1%(4)	210	225	275	250	200	210
Aluminum Chloride, Sat'd(4)	150	205	275	250	200	210
Aluminum Fluoride, Sat'd	NR	75	100	150	70	80(1)(5)
Aluminum Hydroxide, Sat'd	NR	190	200	200	150	180
Aluminum Nitrate, ALL	150	205	250	250	150	180
Aluminum Potassium Sulfate, Sat'd	210	225	275	250	150	210
Aluminum Sulfate, Sat'd	210	225	275	250	200	210
Ammonia, Gas, Dry, Anhydrous(2)(6)	150	225	275	150(1)	100	100(1)
Ammonia, Gas, Wet	---	---	---	150(1)	100	100
Ammonia, Liquid	NR	NR	NR	NR	NR	NR
Ammonium Acetate, 65%	200	225	275	75	75	80
Ammonium Bicarbonate, Sat'd	150	180	225	225	125	150
Ammonium Bisulfite, Black Liquor	NR	---	---	NR	150	180
Ammonium Bisulfite, Cook Liquor	NR	NR	---	NR	150	150
Ammonium Bisulfite, Sat'd	150	225	275	75	150	150
Ammonium Bromate, 43%	NR	NR	---	75	150	160
Ammonium Bromide, 43%	NR	---	---	100	150	160
Ammonium Carbonate, Sat'd	150	205	225	200	125	150
Ammonium Chloride, 25%	150	205	225	200	200	210
Ammonium Chloride, Sat'd	150	205	225	200	200	210
Ammonium Citrate, Sat'd	200	225	275	175	125	150
Ammonium Fluoride, 25%	NR	---	---	150	125	150(5)
Ammonium Fluoride, Sat'd	NR	75	100	100	125	150(5)
Ammonium Hydroxide (Aqueous Ammonia), 5%	120	150	200	150	150	180(5)(7)

Chemical	RED THREAD II	GREEN THREAD	Z-CORE	RB-2530 RB-1520	CL-2030 CL-1520	F-CHEM (9)(20)
Maximum Recommended Service Temperature °F						
Ammonium Hydroxide (Aqueous Ammonia), 10%	120	150	200	150	150	150(5)(7)
Ammonium Hydroxide (Aqueous Ammonia), 20%	100	125	200	150	150	150(5)(7)
Ammonium Hydroxide (Aqueous Ammonia), 28%	100	125	200	100	100	100(5)(7)
Ammonium Hydroxide (Aqueous Ammonia), Sat'd	---	---	175	---	---	---
Ammonium Lauryl Sulfate, 30%	---	---	---	150	120	120
Ammonium Molybdate	---	---	---	100	150	150
Ammonium Nitrate, 25%	210	225	275	250	200	200
Ammonium Nitrate, Sat'd	210	225	210	---	---	200
Ammonium Pentaborate, 12%	---	---	---	NR	120	120
Ammonium Persulfate, Sat'd	NR	---	100	250	180	180
Ammonium Phosphate, 25%	150	200	225	150	190	210
Ammonium Phosphate, 65%	150	200	225	150	190	210
Ammonium Sulfate, Sat'd	200	225	275	250	190	210
Ammonium Sulfide (Bisulfide), Sat'd	NR	NR	100	100	120	120
Ammonium Sulfite	NR	NR	150	NR	NR	120
Ammonium Thiocyanate, 20%	---	---	---	150	190	210
Ammonium Thioglycolate, 8%	---	---	---	100	90	100
Ammonium Thiosulfate, 60%	---	---	---	100	90	100
Amyl Acetate, 100%	75	120	150	NR	NR	NR
Amyl Alcohol	NR	NR	175	150	120	120
Amyl Chloride	NR	NR	100	NR	100	120
Aniline	---	---	120	75	NR	NR
Aniline Hydrochloride, 100%	---	---	100	NR	180	150
Aniline Sulfate, Sat'd	NR	NR	100	NR	200	210
Antimony Trichloride	NR	NR	150	150	200	200
Arsenic Acid (orthoarsenic acid)	---	---	---	NR	100	100
Arsenious Acid	NR	NR	100	---	---	180
Barium Acetate, Sat'd	210	225	275	100	180	190
Barium Bromide	---	---	---	100	200	210
Barium Carbonate, Sat'd	210	225	275	250	200	210
Barium Chloride, Sat'd	210	225	275	250	200	210
Barium Cyanide	---	---	---	200	150	150
Barium Hydroxide, 0 - 10%	180	200	225	200	200	150
Barium Hydroxide, >10%	---	---	---	200	150	150
Barium Sulfate, Sat'd	210	225	275	250	200	210
Barium Sulfide, Sat'd	210	225	275	250	200	180
Beer	210	225	250	200	200	120
Benzaldehyde	NR	NR	200	---	---	NR(3)
Benzene Sulfonic Acid, 50%	NR	NR	100	100	125	180
Benzene Sulfonic Acid, 75%	NR	NR	100	NR	100	180
Benzene Sulfonic Acid, 100%	NR	NR	75	NR	100	180
Benzene, 10%	120	150	180	125	NR	NR(3)
Benzene, 100%	120(1)	150	180	125	NR	NR(3)
Benzene in Kerosene; 5% Benzene	---	---	---	200	200	180
Benzoic Acid, Sat'd	100	150	200	200	200	210
Benzyl Alcohol, 100%	NR	NR	150	NR	NR	NR

3

Chemical	RED THREAD II	GREEN THREAD	Z-CORE	RB-2530 RB-1520	CL-2030 CL-1520	F-CHEM (9)(20)
Maximum Recommended Service Temperature °F						
Benzyl Chloride, 100%	NR	NR	150	NR	NR	NR(3)
Benzyltrimethylammonium Chloride, 60%	---	---	---	150	100	100
Biodiesel (See Methyl Ester)						
Black Liquor (Pulp Mill)	150	225	230	180	180	180(5)(13)
Borax	---	---	---	250	200	210
Boric Acid, Sat'd	200	225	250	200	200	210
Brass Plating Solution	---	---	---	NR	150	180
Brine	210	225	275	250	200	210
Brominated Phosphate Ester	---	---	---	NR	NR	---
Bromic Acid	---	---	---	150	NR	---
Bromine Dry Gas	---	---	---	NR	100	90
Bromine Water, 5%	NR	NR	75	100	100	180
Bromine, 10%	NR	NR	NR	NR	NR	NR
Bromine, Liquid, Wet Gas	NR	NR	NR	NR	NR	NR
Brown Stock	---	---	---	NR	100	180(9)
Bromoform	NR	NR	185	---	---	---
Butane, 100%(6)	75(1)	75(1)	100(1)	180	100	NR
Butadiene, Gas	NR	NR	200	100	100	(9)
Butanol (Alcohol, Normal Butyl)	120	150	200	120	100	120
2-Butoxyethoxyethanol	---	---	---	NR	NR	100
Butyl Acetate, 100%	75	150	175	100	NR	NR
Butyl Acrylate	---	---	---	NR	NR	NR(3)
Butyl Alcohol (Sec.), 10%	175	175	200	150	NR	120
Butyl Alcohol, 100%	120	150	200	150	NR	120
Butyl Benzoate, 70%	---	150	200	NR	NR	---
Butyl Benzyl Phthalate, 100%(4)	---	---	120	125	100	150
Butyl Carbitol Diethylene Glycol	---	---	---	NR	80	NR
Butyl CELLOSOLVE	150	150	175	150	100	100
Butylene Glycol, 100%	150	150	250	200	150	160
Butyl Phthalate	NR	NR	125	NR	NR	(9)
Butyric Acid, 0-25%	NR	---	100	150	175	210
Butyric Acid, 25-50%	NR	---	100	150	150	210
Cadmium Chloride, Sat'd	---	---	---	220	180	180
Cadmium Cyanide Plating Solution	---	---	---	NR	150	180
Calcium Bisulfite, Sat'd	NR	NR	100	200	180	180
Calcium Bromide	---	---	---	210	200	200
Calcium Carbonate, Sat'd	150	205	275	250	150	180
Calcium Chlorate, Sat'd	180	180	200	200	200	210
Calcium Chloride, Sat'd	210	225	275	250	200	210
Calcium Hydroxide, 15%	200	225	275	200	150	180
Calcium Hydroxide, 15-50%	200	225	275	200	150	180(5)
Calcium Hydroxide, >50%	200	225	275	200	150	180(5)
Calcium Hypochlorite, 10%(21)	---	---	---	100	125	160(7)(9)(10)
Calcium Hypochlorite, Sat'd(21)	NR	NR	NR	NR	NR	160(7)(9)(10)

Chemical	RED THREAD II	GREEN THREAD	Z-CORE	RB-2530 RB-1520	CL-2030 CL-1520	F-CHEM (9)(20)
Maximum Recommended Service Temperature °F						
Calcium Nitrate, Sat'd	150	205	275	250	200	210
Calcium Sulfate, Sat'd	200	225	275	250	200	210
Calcium Sulfite, Sat'd	NR	NR	100	225	180	180
Cane Sugar Liquor, Sat'd	200	225	250	225	180	180
Capric Acid	---	---	---	NR	80	160
Caprylic Acid, Sat'd	NR	NR	100	NR	150	180
Carbolic Acid (See Phenol)						
Carbon Dioxide Gas, Dry(6)	210	225	275	250	200	210
Carbon Dioxide, Wet Acidic(6)	210	225	250	---	---	210
Carbon Disulfide	120	120	150	---	---	NR
Carbon Monoxide Gas	---	---	250	250	200	210(9)
Carbon Tetrachloride, 100%	150	150	175	100	125	100
Carbonic Acid	150	150	150	150	150	150
Carbo Wax	---	---	---	NR	150	100
Carboxyethyl Cellulose, 10%	---	---	---	75	150	150
Carboxymethyl Cellulose, 10%	NR	NR	100	75	125	150
Cascade Detergent in Solution	---	---	---	100	180	180
Castor Oil	210	225	250	200	160	160
Caustic Soda (See Sodium Hydroxide)						
CELLOSOLVE	NR	NR	150	NR	NR	(9)
Chlorinated Wax	NR	NR	150	75	125	180
Chlorine Liquid	NR	NR	NR	NR	NR	NR
Chlorine Saturated Brine(11)	NR	NR	75	NR	---	(9)
Chlorine Water, Sat'd	NR	NR	75	NR	200	180(9)
Chlorine, Dry Gas, 100%(2)(6)	NR	NR	NR	125	200	210(9)(12)
Chlorine, Wet Gas, 100%(2)(9)	NR	NR	NR	NR	200	210(9)(12)
Chlorine Dioxide, 15%	---	150	150	75	150	180(9)
Chlorine Dioxide, 100%	NR	NR	NR	NR	---	160(9)
Chloroacetic Acid, 10%	100	120	150	100	100	100(9)
Chloroacetic Acid, 25%	---	---	100	100	100	100(9)
Chloroacetic Acid, 50%	NR	NR	100	NR	75	100(9)
Chloroacetic Acid, Glacial	NR	NR	100	NR	NR	NR(9)
Chlorobenzene, 100%	100(1)	150(1)	200	---	NR	NR
Chloroform, 100%	NR	NR	185	100(9)	NR	NR
Chloromethane (Methyl Chloride)	NR	NR	75	NR	NR	NR
2-Chlorophenol	---	---	100	---	---	---
Chlorosulfonic Acid, 100%	NR	NR	75	NR	NR	NR
Chromic Acid, 5%	NR	NR	75	120	100	100(13)
Chromic Acid, 10%	NR	NR	75	100	100	100(13)
Chromic Acid, 15%	NR	NR	75	75	100	100(13)
Chromic Acid, 15-20%	NR	NR	NR	75	100	100(13)
Chromic Fluoride	---	---	---	75	75	---
Chromium Plate	---	---	---	NR	100	120
Chromium Sulfate, Sat'd	---	---	100	125	180	150
Cinnamaldehyde, 50%	---	---	---	NR	NR	---
Cinnamic Acid, 50%	---	---	---	NR	100	---

5

Chemical	RED THREAD II	GREEN THREAD	Z-CORE	RB-2530 RB-1520	CL-2030 CL-1520	F-CHEM (9)(20)
Maximum Recommended Service Temperature °F						
Cinnamic Alcohol, 50%	---	---	---	NR	NR	---
Citric Acid, 15%	210	225	225	150	150	210
Citric Acid, Sat'd	210	225	225	200	200	210
Cobalt Chloride	---	---	---	200	180	180
Coca-Cola (syrup)	100	150	NR	---	NR	---
Coconut Oil	200	225	275	100	180	180
Copper Acetate	---	---	200	---	---	160
Copper Carbonate	---	---	200	---	---	---
Copper Brite Plating: Caustic-Cyanide	---	---	100	NR	NR	160
Copper Chloride, Sat'd	150	205	225	250	200	210
Copper Cyanide, Sat'd	150	205	225	140	200	210
Copper Fluoride, Sat'd	---	200	225	250	175	210
Copper Nitrate, Sat'd	150	200	210	200	200	210
Copper Matte Dipping Bath	---	---	200	NR	NR	180
Copper Plating Solution, Cyanide Based	---	---	---	NR	150	160(5)
Copper Plating Solution, Fluoroborate	NR	NR	NR	NR	NR	180
Copper Pickling Bath: 10% Ferric Sulfate	NR	---	150	NR	200	200
Copper Sulfate, Sat'd	150	200	250	200	200	210
Corn Oil	200	225	275	200	200	180
Corn Starch, Slurry	200	225	275	---	---	210
Corn Sugar	200	225	275	---	---	210
Cottonseed Oil	200	225	275	200	210	210
Cresol, 5%	75	120	200	---	---	---
Cresol, 10%	NR	75	200	---	---	---
Cresol, 100%	---	---	200	---	---	---
Cresylic Acid, 100%	NR	NR	100	NR	---	NR
Crude Oil Sour, 100%	210	225	275	250	200	210
Crude Oil, Sweet, 100%	210	225	275	250	200	210
Cupric Chloride, 5%	---	---	200	---	---	---
Cupric Chloride, 50%	---	---	200	---	---	---
Cyclohexane, 100%	150	150	175	NR	110	120
Cyclohexanol	---	---	200	---	---	---
Cyclohexanone, 100%	100(1)	100(1)	125	---	---	NR
Decanoic Acid	---	---	---	NR	80	160
Detergents, Sulfonated	210	225	275	200	150	200
Di-Ammonium Phosphate, 65%	150	225	275	150	150	210
Diacetone Alcohol	---	---	---	150	NR	---
Diallyl Phthalate (DAP)	---	---	150	NR	150	180
Dibromophenol, 100%	NR	NR	100	NR	NR	NR
Dibutyl Carbitol	---	---	---	NR	75	80
Dibutyl Ether, 100%	100(1)	100(1)	125	NR	75	100
Dibutyl Sebacate	---	---	---	NR	NR	120
Dichloroacetic Acid	NR	NR	100	NR	NR	(9)
Dichlorobenzene (Ortho), 100%	150	150	180	---	---	NR

Chemical	RED THREAD II	GREEN THREAD	Z-CORE	RB-2530 RB-1520	CL-2030 CL-1520	F-CHEM (9)(20)
Maximum Recommended Service Temperature °F						
Dichloroethane	---	---	185	NR	NR	NR(3)
Dichloroethylene, 100%	---	---	185	75	NR	NR
Dichloromethane (Methylene Chloride)	---	---	100	---	---	NR
Dichloromonomethane, 100%	---	---	125	---	---	NR
Dichloropropane, 100%	---	---	185	---	---	NR
Dichloropropene, 100%	---	---	185	---	---	NR(3)
Dichloropropionic Acid	---	---	---	NR	NR	NR
Diesel Fuel	210	225	275	250	180	180
Diethanolamine, 100%	120	120	150	NR	NR	80
Diethylamine, 100%	NR	NR	100	NR	NR	NR
Diethyl Benzene, 100%	150	150	185	---	---	80
Diethyl Carbonate, 100%	NR	NR	100	NR	NR	NR
Diethylene Glycol, 100%	210	225	275	200	150	180
Diethylhexyl Phosphoric Acid, 20% Kerosene	---	---	---	NR	150	120
Diethyl Sulfate, 100%	---	---	100	NR	NR	NR
Diethylene Triamine, 10%	NR	NR	120	---	---	---
Diisobutyl Phthalate, 100%	150	150	175	NR	100	120
Diisobutylene, 100%	150	200	225	NR	80	90
Diisopropanolamine, 100%	---	---	120	NR	110	100
Dimethyl Formamide, 100% (DMF)	NR	NR	100	NR	NR	NR
Dimethyl Morpholine, 100%	NR	NR	100	NR	NR	NR
Dimethyl Phthalate, 100%	150	150	175	NR	125	150
Diocetyl Phthalate, 100% (DOP)	150	150	175	NR	125	150
Dioxane	NR	75	125	---	---	NR
Diphenyl Oxide	(9)	(9)	(9)	NR	NR	80
Dipotassium Phosphate, 50%	---	---	---	150	100	---
Dipropylene Glycol, 100%	210	225	275	200	150	180
Disodium Phosphate, 75%	---	150	150	150	100	---
Distillery Stillage	150	150	175	---	---	---
Distillery Syrup	150	150	175	---	---	---
Divinyl Benzene	100(1)	100(1)	175	---	---	NR
Dodecene	---	---	---	NR	100	150
Dodecyl Alcohol, 100%	150	200	225	NR	125	150
Dodecyl Benzene Sulfonic Acid	---	---	---	75	100	200
DOW Latex 2144	210(1)	225	275	---	---	---
DOW Latex 560	210(1)	225	275	---	---	---
DOW Latex 700	210(1)	225	275	---	---	---
DOWANOL EE	75	75	100	---	---	---
DOWANOL EM	NR	NR	100	---	---	---
DOWFAX 9N9-Surfactant	100(1)	100(1)	100	---	---	---
ELECTROSOL, 5%	150	200	225	100	75	150
Epichlorohydrin, 100%	NR	NR	100	---	---	NR
Epoxidized Soybean Oil, 100%	200	225	275	NR	150	150
Esters, Fatty Acids, 100%	200	225	275	100	150	180
Ethanol (see Ethyl Alcohol)						
Ethyl Acetate, 100%	75	120	150	---	---	NR(3)

7

Chemical	RED THREAD II	GREEN THREAD	Z-CORE	RB-2530 RB-1520	CL-2030 CL-1520	F-CHEM (9)(20)
Maximum Recommended Service Temperature °F						
Ethyl Acrylate, 100%	120	120	150	---	---	NR
Ethyl Alcohol, 10%	150	175	200	150	100	120(3)
Ethyl Alcohol, 95-100%	120	120	175	125	NR	80(3)
Ethyl Amines	NR	NR	---	NR	NR	NR
Ethyl Benzene, 100%	120	150	185	---	---	NR
Ethyl Bromide, 100%	---	---	100	---	---	NR
Ethyl Cellosolve	---	---	---	100	NR	---
Ethyl Chloride, 100%	---	---	100	75	NR	NR
Ethyl Ether, 100%	100(1)	100(1)	120	---	---	NR
Ethyl Sulfate, 100%	NR	NR	100	---	---	80
Ethylene Dichloride, EDC	---	---	185	NR	NR	NR(3)
Ethylene Glycol, 50% (in water)	210	225	275	200	200	210
Ethylene Glycol, 100%	210	225	275	200	200	210
Ethylenediaminetetraacetic Acid	---	---	---	75	100	80
Eucalyptus Oil	---	---	---	150	140	140
Fatty Acids, Sat'd	210	225	275	200	200	210
Ferric Acetate, Sat'd	---	---	---	150	160	180
Ferric Chloride, Sat'd	150	205	275	250	200	210
Ferric Nitrate, Sat'd	150	205	275	250	200	210
Ferric Sulfate, Sat'd	210	225	275	200	200	210
Ferrous Chloride, Sat'd	210	225	275	250	200	210
Ferrous Chloride, 5% HCL	---	---	---	210	175	---
Ferrous Nitrate, Sat'd	210	225	275	200	200	210
Ferrous Sulfate, Sat'd	210	225	275	200	200	210
Fertilizer (8-8-8)	210	225	275	NR	120	120
Fertilizer-Urea Ammonium Nitrate	210	225	275	75	120	120
Flue Gas	210	225	275	225	180	180(9)
Fluoboric Acid, Sat'd	NR	NR	75	---	150	210(5)
Fluorine Gas, Dry	---	---	---	75	75	80(5)
Fluorine Gas, Wet	---	---	---	NR	150	80(5)
Fluorobenzene (phenyl fluoride)	---	---	180	---	---	---
Fluosilicic Acid, 10%	NR	100(1)	125	NR	80	180(5)
Fluosilicic Acid, 25%	NR	100(1)	125	NR	100	100(5)
Formaldehyde, 25%	75	120(1)	150	75	75	120
Formaldehyde, 37%	75	120(1)	150	75	75	120
Formaldehyde, 40%	75	120(1)	150	75	75	120
Formaldehyde, Sat'd	75	120(1)	150	NR	NR	120
Formic Acid, 0-10%	NR	NR	120	140	100	180
Formic Acid, 10-25%	NR	NR	120	100	100	100
Formic Acid, 25-88%	NR	NR	120	---	---	100
Formic Acid, Sat'd	NR	NR	100	---	---	100
Freon 11	75	75	75	150	75	80
Freon 12 OR 22 (Gas or Liquid)	NR	75	75	150	75	80
Fuel Oil, 100%	210	225	275	175	200	180

Chemical	RED THREAD II	GREEN THREAD	Z-CORE	RB-2530 RB-1520	CL-2030 CL-1520	F-CHEM (9)(20)
Maximum Recommended Service Temperature °F						
Fumaric Acid, 25%	---	---	---	100	100	---
Furfural, 5%	100	135	150	---	---	100
Furfural, 10%	100	110	125	---	---	100
Furfural, 100%	NR	NR	100	---	---	NR
Gallic Acid, Sat'd	---	---	---	NR	125	100
Gas, Natural(6)	210	225	275	200	200	210
Gasoline	210	225	250	150	NR	120(9)
Gasoline/Ethanol Mixtures	210	225	---	---	NR	---
Glycolic Acid, 50%	100	100	120	---	---	180
Glucose, 100%	210	225	275	250	200	210
Gluteraldehyde, 50%	120	120	150	---	75	120
Glutaric Acid, 50%	120	120	150	75	100	120
Glycerine, 100%	210	225	275	250	200	210
Glycol Ethylene	210	225	275	200	200	200
Glycolic Acid, 10%	NR	NR	100	NR	75	180
Glycolic Acid, 70%	NR	NR	100	NR	75	80
Glyoxal, 40%	120(1)	120(1)	125	NR	100	80
Glyoxal, Sat'd	120(1)	120(1)	120	NR	NR	---
Gold Plating Solution	---	---	---	---	---	180
Green Liquor (Pulp Mill)	100	205(1)	225	---	---	180(8)
Heptane	200	200	225	150	150	200
Hexamethylenetetramine, 40%	---	---	---	100	75	100
Hexane	150(1)	150(1)	175	125	150	150
Hexylene Glycol	210	225	250	150	150	150
Hot Stack Gases	210	225	275	(9)	(9)	(9)
Hydrated Lime (Calcium Hydroxide)	150	200	225	200	175	180
Hydraulic Fluid, 0-60%	200	225	250	200	100	180
Hydraulic Fluid, 100%	200	225	250	---	---	180
Hydroiodic Acid, 40%	(9)	(9)	(9)	NR	NR	150
Hydrobromic Acid, 0-18%	NR	150(15)	150	150	100	180
Hydrobromic Acid, 18-48%	NR	100(15)	100	100	100	150
Hydrobromic Acid, 48-62%	NR	100(15)	100	100	NR	100
Hydrochloric Acid, 0-1%(16)	75	150(15)	200	200	175	180(8)
Hydrochloric Acid, 1-5%(16)	NR	150(15)	200	200	175	180(8)
Hydrochloric Acid, 10%(16)	NR	150(15)	200	200	175	180(8)
Hydrochloric Acid, 20%(23)	NR	100	200(16)	200(9)(16)	175(16)	160(17)
Hydrochloric Acid, 37%, (36.5% Muriatic)(16)(23)	NR	NR	150	140(9)	150	140(17)
Hydrocyanic Acid, 10%	NR	NR	100	120	150	180
Hydrocyanic Acid, Sat'd (Prussic)	NR	NR	100	---	---	180
Hydrofluoric Acid, 1%	NR	75	75	NR	150	150(5)
Hydrofluoric Acid, 5%	NR	75(15)	75	NR	150	150(5)
Hydrofluoric Acid, 10%	NR	75	75	NR	150	125(5)
Hydrofluoric Acid, 20%	NR	NR	NR	NR	NR	100(5)
Hydrofluoric Acid, >50%	NR	NR	NR	NR	NR	NR
HF, 2.5% and HCl, 1.5%	NR	NR	NR	NR	---	(9)

Chemical	RED THREAD II	GREEN THREAD	Z-CORE	RB-2530 RB-1520	CL-2030 CL-1520	F-CHEM (9)(20)
Maximum Recommended Service Temperature °F						
Hydrofluosilicic Acid, 10% (Fluosilicic Acid)	NR	100(1)	125	NR	80	180(5)
Hydrofluosilicic Acid, 25% (Fluosilicic Acid)	NR	100(1)	125	NR	100	100(5)
Hydrofluosilicic Acid, 37% (Fluosilicic Acid)	NR	NR	150	NR	NR	100(5)
Hydrogen Bromide, Wet Gas, 100%(6)	NR	NR	NR	---	---	180
Hydrogen Chloride, Dry Gas, 100%(2)(6)	150	150	150	---	---	210(9)
Hydrogen Chloride, Wet Gas, 100%(6)	NR	NR	NR	NR	---	210(9)
Hydrogen Fluoride, Vapor	NR	NR	NR	NR	180	180(5)
Hydrogen Peroxide, 0-10%	NR	NR	75	75	NR	125(9)(10)
Hydrogen Peroxide, 10-20%	NR	NR	75	NR	NR	125(9)(10)
Hydrogen Peroxide, 20-30%	NR	NR	75	NR	NR	125(9)(10)
Hydrogen Sulfide, Dry Gas(2)(6)	200	200	200	250	175	210
Hydrogen Sulfide, Wet Gas, Sat'd(6)	200	200	200	250	175	210
Hydrosulfite Bleach	NR	NR	NR	NR	150	180
Hydroxyacetic Acid (Glycolic Acid 70%)	NR	NR	100	NR	75	80
Hypochlorous Acid, 10%	NR	NR	NR	NR	NR	150
Hypochlorous Acid, 20%	NR	NR	NR	NR	NR	120
Hypophosphorous Acid, 50%	NR	NR	---	NR	120	90
Iodine, Sat'd Vapor at room temp	120	150	200	NR	100	150
Isobutyric Acid, 50%	---	---	---	75	100	---
Isobutyl Alcohol, 10%	---	---	---	100	100	120
Isocaproic Acid	---	---	---	100	75	---
Isononyl Alcohol	---	---	---	125	115	150
Isooctyl Adipate	---	---	---	NR	NR	120
Isooctyl Alcohol	---	---	---	125	75	150
Isophthalic Acid (liquor)	100	150	200	---	180	(9)
Isopropyl Alcohol, 10%	150	150	175	175	120	120
Isopropyl Alcohol, 100%	120	120	150	150	NR	120
Isopropyl Ether	125	150	150	---	---	---
Isopropyl Myristate	---	---	---	200	75	200
Isopropyl Palmitate, 100%	200	225	275	200	200	210
Itaconic Acid, 25%	---	---	---	200	120	120
Jet Fuel	150	225	275	250	175	180(9)
Kerosene	210	225	275	250	175	180
Lactic Acid	200	225	275	200	150	210
Lasso Herbicide	---	---	---	NR	NR	NR
Latex	210	225	275	200	120	120
Lauric Acid, Sat'd	200	225	275	200	150	210
Lauroyl Chloride, 100%	---	---	---	NR	120	100
Lauryl Alcohol	---	---	---	100	200	120
Lauryl Chloride, 100%	---	---	200	100	200	200
Lead Acetate, Sat'd	150	200	275	250	200	210
Lead Nitrate, Sat'd	150	200	225	---	---	210
Lead Plating Solution	NR	---	---	---	---	180(5)(9)
Levulinic Acid	200	225	250	200	200	210
Lime Slurry	200	225	275	200	150	180(5)

Chemical	RED THREAD II	GREEN THREAD	Z-CORE	RB-2530 RB-1520	CL-2030 CL-1520	F-CHEM (9)(20)
Maximum Recommended Service Temperature °F						
Linseed Oil	200	225	275	225	200	210
Lithium Bromide, Sat'd	200	225	275	100	200	210
Lithium Carbonate, Sat'd	---	---	---	140	100	150(5)
Lithium Chloride, Sat'd	210	225	275	210	200	210
Lithium Hydroxide, Sat'd	150	205(1)	225	---	---	150
Lithium Sulfate, Sat'd	210	225	275	100	200	210(5)
Magnesium Bisulfate, Sat'd	---	---	---	200	150	---
Magnesium Bisulfite, Sat'd	200	200	225	100	150	180
Magnesium Carbonate, Sat'd	150	200	275	250	175	180
Magnesium Chloride, Sat'd	210	225	275	250	200	210
Magnesium Fluosilicate	---	---	---	225	100	180(5)
Magnesium Hydroxide, Sat'd	120	205	275	250	150	210
Magnesium Nitrate, Sat'd	210	225	275	250	200	210
Magnesium Phosphate	---	---	---	250	150	120
Magnesium Sulfate, Sat'd	210	225	275	250	200	210
Maleic Acid	150	150	175	150	200	200
Maleic Anhydride	150	150	175	---	---	150
Manganese Chloride, 0% - Sat'd	210	225	250	225	180	210
Manganese Sulfate	---	---	---	225	200	210
Mercaptoacetic Acid	---	---	---	NR	NR	NR
Mercuric Chloride, Sat'd	210	225	275	150	200	210
Mercurous Chloride, Sat'd	210	225	275	150	200	210
Mercury	---	---	---	250	200	210
Methane(6)	210	225	275	150	140	140
Methanol (see Methyl Alcohol)						
Methyl Acetate	75	120	150	---	---	---
Methyl Alcohol, 10%	120	150	175	150	100	100(3)
Methyl Alcohol, 20 - 80%	120	150	175	100	NR	NR
Methyl Alcohol, 100%	100	120	150	100	NR	NR(3)
Methyl Chloride	NR	NR	75	NR	NR	NR
Methyl Ester (Biodiesel)	210	225	275	250	180	180
Methyl Ethyl Ketone, 5% MEK	---	---	---	100	NR	NR(3)
Methyl Ethyl Ketone, 100% MEK	75	150	175	---	---	NR(3)
Methyl Isobutyl Carbitol, 100%	---	---	150	100	NR	NR
Methyl Isobutyl Ketone, 100%	100	150	175	150	NR	NR
Methyl Methacrylate Monomer	125	125	---	---	---	---
Methyl Styrene, 100%	75	75	175	---	---	NR
Methyl Tert-Butyl Ether, 100%	75	75	100	---	---	---
Methylacetic (See Propionic Acid)						
Methylene Chloride, 100%	NR	NR	100	NR	NR	NR
Mineral Oils	210	225	275	250	200	200
Mineral Spirits, 100%	210	225	275	---	---	220
Monochloro Acetic Acid, 100%	NR	NR	100	NR	NR	NR(9)
Monochlorobenzene	100(1)	150(1)	200	---	---	NR
Monoethanolamine, 100%	110	110	150	NR	NR	NR
Motor Oil	210	225	275	250	200	210

Chemical	RED THREAD II	GREEN THREAD	Z-CORE	RB-2530 RB-1520	CL-2030 CL-1520	F-CHEM (9)(20)
Maximum Recommended Service Temperature °F						
Muriatic Acid (See Hydrochloric Acid)(16)						
Myristic Acid, 100%	---	---	250	150	175	210
Naphtha, 100%	210	225	275	200	175	180(3)
Naphthalene, 100%	200	200	225	150	100	210
Natural Gas(6)	210	225	275	150	140	140
Nickel Chloride, Sat'd	210	225	275	250	200	210
Nickel Nitrate, Sat'd	210	225	275	200	200	210
Nickel Plating Solution	(9)	(9)	(9)	(9)	(9)	180
Nickel Sulfate, Sat'd	210	225	275	225	200	210
Nitric Acid, 1%(19)	75	120(15)	150	120	150	150(13)
Nitric Acid, 5%	75	100(15)	150	120	150	150(13)
Nitric Acid, 10%	75	100(15)	120	120	125	120(13)
Nitric Acid, 20%	NR	75(15)	75	NR	NR	120(13)
Nitric Acid, 25%	NR	75(15)	75	NR	NR	NR
Nitric Acid, 35-70%	NR	NR	NR	NR	NR	NR
Nitriiotriacetic Acid, NTA	---	---	---	---	---	---
Nitrobenzene, 100%	---	---	200	NR	NR	NR
Oakite Rust Stripper	---	---	---	150	100	180
Octanoic Acid, Sat'd "Caprylic Acid"	---	---	225	NR	150	180
Oil, Sour Crude, 100%	210	225	275	225	200	210
Oil, Sweet Crude, 100%	210	225	275	250	200	210
Oleic Acid, 100%	200	225	275	200	100	210
Oleum "Fuming Sulfuric"	NR	NR	100(9)	NR	NR	NR
Olive Oil, 100%	210	225	275	200	200	210
Oxalic Acid, Sat'd	150	200	225	200	200	210
Ozone, 5mg/L	---	---	---	150	100	80(9)
Ozone 0-15 ppm	150	150	(9)	(9)	(9)	(9)
Ozone 0-35 ppm	NR	150	(9)	(9)	(9)	(9)
Ozone 0-300 ppm	NR	NR	(9)	(9)	(9)	(9)
Palmitic Acid	---	---	---	150	100	210
Perchloric Acid, 10%(18)	---	---	---	75	150	150
Perchloric Acid, 30%(18)	---	---	---	75	75	100
Perchloroethylene, 100%	100	100(1)	150	120	75	80
Phenol Sulfonic Acid, 1-5%	---	---	---	---	200	---
Phenol Sulfonic Acid, 100%	NR	NR	NR	NR	NR	NR
Phenol, 1% "in water"	75	150(15)	175	150	NR	NR
Phenol, 5% "in water"	NR	150(15)	175	NR	NR	NR
Phenol, 10-88% "in water"	NR	NR	100(9)	NR	NR	NR
Phosphoric Acid, 2%(19)	100	225(15)	200	100	200	210
Phosphoric Acid, 25%	75	150(15)	150	100	200	210
Phosphoric Acid, 50%	75	150(15)	75	75	200	210
Phosphoric Acid, 85%	NR	75(15)	NR	NR	175	210
Phosphorus Pentoxide, 0-54%	---	---	---	100	200	210
Phosphorus Trichloride, 100%	NR	NR	---	NR	NR	NR

Chemical	RED THREAD II	GREEN THREAD	Z-CORE	RB-2530 RB-1520	CL-2030 CL-1520	F-CHEM (9)(20)
Maximum Recommended Service Temperature °F						
Phthalic Acid, All	---	---	---	NR	200	210
Phthalic Anhydride, 25%	---	---	---	NR	150	210
Picric Acid "Alcoholic", 10%	NR	NR	---	---	NR	100
Picric Acid, Sat'd	NR	---	100	---	---	NR
Pine Oil	---	---	---	200	NR	---
Polyethyleneimine, 10%	---	---	---	NR	100	150
Polyvinyl Acetate Adhesives	---	---	---	150	120	120
Polyvinyl Acetate Latex "PVCa"	210	225	250	150	100	210
Polyvinyl Alcohol, 100% "PVA"	150	150	175	100	100	120
Polyvinyl Chloride Latex W/35 parts DOP	NR	NR	---	NR	120	120
Potassium Alum Sulfate, Sat'd	210	225	275	120	200	210
Potassium Bicarbonate, 0-50%	150	200	225	225	150	150(5)
Potassium Bicarbonate, >50%	---	---	---	225	100	150(5)
Potassium Bromide, Sat'd	210	225	275	200	100	160
Potassium Carbonate, <14%	200	205	275	250	150	150(5)
Potassium Carbonate, 14-50%	150	205	275	250	150	140(5)
Potassium Carbonate, 50%-Sat'd	150	205	275	250	150	90
Potassium Chloride, Sat'd	210	225	275	250	200	210
Potassium Cyanide, 5%	210	225	275	---	---	---
Potassium Dichromate, Sat'd	---	---	---	250	200	210
Potassium Ferricyanide, Sat'd	200	225	275	250	200	210
Potassium Ferrocyanide, Sat'd	200	225	275	225	200	210
Potassium Fluoride, 30%	150	150	150	---	---	150
Potassium Gold Cyanide, 12%	---	---	---	225	100	100
Potassium Hydroxide, 0-25%	100	150	240	200	125	150(5)(7)(13)
Potassium Hydroxide, 25-50%	100	150	240	200	125	150(5)(7)(13)
Potassium Hydroxide, Sat'd "Potash"	100	150	225	---	---	150(5)(7)(13)
Potassium Iodide	---	---	---	225	120	120
Potassium Nitrate, Sat'd	200	225	275	250	200	210
Potassium Permanganate, 5%	150	200	225	125	200	210
Potassium Permanganate, 10%	NR	150(15)	175	125	200	210
Potassium Permanganate, Sat'd	NR	NR	---	125	200	210
Potassium Persulfate, Sat'd	---	---	---	225	200	210
Potassium Pyrophosphate, 60%	---	---	---	225	135	100
Potassium Sulfate, Sat'd	210	225	275	225	200	210
Propane Gas(6)	75(1)	75(1)	100	100	200	120
Propionic Acid, 20%	100	120	120	100	150	180
Propionic Acid, 50%	---	---	120	100	NR	180
Propionic Acid, 100%	---	---	100	100	NR	NR
Propylene Glycol	210	225	275	200	200	210
Prussic Acid (see Hydrocyanic Acid)						
Pyridine, 100%	---	---	125	---	---	NR
Rayon Spin Bath	---	---	---	NR	NR	150
Red Liquor	---	---	---	NR	100	150
Salicylic Acid, Sat'd	---	---	---	125	125	140

Chemical	RED THREAD II	GREEN THREAD	Z-CORE	RB-2530 RB-1520	CL-2030 CL-1520	F-CHEM (9)(20)
Maximum Recommended Service Temperature °F						
Sebacic Acid, Sat'd	---	---	---	---	---	210
Selenious Acid, Sat'd	---	---	---	NR	200	210
Silicic Acid	---	---	---	200	125	210
Silver Nitrate, Sat'd	150	225	275	250	200	210
Silver Plating Solution (See note)	---	---	---	---	---	180
Soaps	200	225	275	250	200	210
Soda Ash (See Sodium Sulfate)						
Sodium Acetate, Sat'd	150	205	225	250	200	210
Sodium Alkyl Aryl Sulfonates	150	205	225	125	150	150
Sodium Aluminate, Sat'd	150	205	225	200	120	120
Sodium Benzoate, Sat'd	---	---	250	250	150	180
Sodium Bicarbonate, Sat'd	200	205	275	250	150	180(5)
Sodium Bifluoride, Sat'd	NR	---	---	---	---	120(5)
Sodium Bisulfate, Sat'd	150	205	225	250	200	210
Sodium Bisulfite, Sat'd	200	205	250	250	200	210
Sodium Borate, Sat'd	---	---	---	225	200	210
Sodium Bromate, 10%	NR	---	---	125	140	210
Sodium Bromide, Sat'd	210	225	275	200	200	210
Sodium Carbonate, 10%	200	205	225	250	150	180(5)
Sodium Carbonate, 25%	150	205	225	250	180	180(5)
Sodium Carbonate, 35%	150	205	225	250	180	180(5)
Sodium Carbonate, 50% (Sat'd)	150	205	225	250	---	160
Sodium Chlorate, Sat'd	---	180	200	225	200	210
Sodium Chloride, Sat'd	210	225	275	250	200	210
Sodium Chlorite, 25%	(9)	(9)	(9)	125	100	160
Sodium Chlorite, Sat'd	NR	NR	---	---	---	100
Sodium Chloroacetate	---	---	---	NR	100	---
Sodium Chromate, Sat'd	---	---	---	150	200	210
Sodium Cyanide, 6%	210	225	250	250	200	210
Sodium Cyanide, Sat'd	NR	NR	---	250	200	210
Sodium Dichromate, Sat'd	---	---	---	250	200	210
Sodium Dodecylbenzenesulfonate	---	---	---	175	160	160
Sodium Diphosphate	---	---	---	210	200	210
Sodium Ferricyanide, Sat'd	200	225	275	250	200	210
Sodium Ferrocyanide, Sat'd	200	225	275	250	200	210
Sodium Fluoride, Sat'd	150	150	200	200	150	180(5)
Sodium Fluorosilicate, Sat'd	---	---	---	150	120	120(5)
Sodium Hexametaphosphate, Sat'd	---	---	---	150	100	120
Sodium Hydrosulfide, Sat'd	NR	---	---	NR	100	180
Sodium Hydroxide, 1%(19)	125(15)	150(15)	200	200	100	180(5)(7)(13)
Sodium Hydroxide, 2%	125(15)	150(15)	200	200	100	160(5)(7)(13)
Sodium Hydroxide, 5%	125(15)	150(15)	200	200	100	160(5)(7)(13)
Sodium Hydroxide, 10%	125(15)	150(15)	215(1)	200	100	160(5)(7)(13)
Sodium Hydroxide, 20%-25%	125(15)	150(15)	200	200	100	150(5)(7)(13)
Sodium Hydroxide, 30%	125(15)	150(15)	200	200	150	150(5)(7)(13)

Chemical	RED THREAD II	GREEN THREAD	Z-CORE	RB-2530 RB-1520	CL-2030 CL-1520	F-CHEM (9)(20)
Maximum Recommended Service Temperature °F						
Sodium Hydroxide, 50%	125(15)	150(15)	240	200	150	100(5)(7)(13)
Sodium Hydroxide, Sat'd	---	---	240	---	---	---
Sodium Hypochlorite, 0-10%(14)(22)	NR	NR	NR	75(9)	75(9)	150(7)(9)(10)
Sodium Hypochlorite, 10-15%(14)(22)	NR	NR	NR	NR	NR	150(7)(9)(10)
Sodium Lauryl Sulfate, Sat'd	---	---	---	200	160	180
Sodium Metabisulfite (see Sodium Bisulfite)						
Sodium Monophosphate, Sat'd	---	---	---	210	200	210
Sodium Nitrate, Sat'd	200	225	275	250	200	210
Sodium Nitrite, Sat'd	200	225	275	---	---	210
Sodium Oxalate, Sat'd	---	---	---	210	200	180
Sodium Persulfate, 20%	NR	75	---	---	---	130
Sodium Phosphate, 10%	---	---	---	200	200	210
Sodium Phosphate, Sat'd	---	---	---	200	200	210
Sodium Silicate, Sat'd	---	200	225	150	200	210(5)
Sodium Sulfate, Sat'd "Soda Ash"	200	225	275	250	200	210
Sodium Sulfide, 0-15%	210	225	250	150	200	210
Sodium Sulfide, Sat'd	---	---	---	200	200	210
Sodium Sulfite, Sat'd	200	205	---	200	200	210
Sodium Tartate	---	---	---	225	200	210
Sodium Tetraborate, Sat'd	---	---	---	200	150	200
Sodium Thiocyanate, 57%	---	200	225	175	150	180
Sodium Thiosulfate, Sat'd	---	150	200	150	150	180
Sodium Tripolyphosphate, Sat'd	100	200	225	200	200	210
Sodium Xylene Sulfonate, Sat'd	---	---	---	125	175	210
Sorbitol Solutions	100	150	225	200	160	160
Soya Oil, 100%	210	225	275	225	200	210
Soybean Fatty Acid	210	225	275	---	---	---
Stannic Chloride, Sat'd	150	205	225	200	200	210
Stannous Chloride, Sat'd "Tin Chloride"	150	205	225	140	200	210
Steam Condensate, Pumped	NR	(9)	---	---	---	---
Stearic Acid	200	225	275	150	200	210
Styrene, 100%	75	75	185	---	---	NR
Succinonitrile	---	---	120	NR	70	100
Sugar, Beet or Cane Liquor, Sat'd	200	225	275	200	100	180
Sugar, Sucrose, Sat'd	200	225	275	225	200	210
Sulfamic Acid, 0-10%	100	150	150	125	200	210
Sulfamic Acid, 10-25%	100	150	150	125	150	150
Sulfamic Acid, >25%	---	---	---	NR	150	210
Sulfanilic Acid, Sat'd	---	---	---	---	---	210
Sulfate Liquor	---	---	---	NR	200	200
Sulfite Liquor	---	---	---	---	200	200
Sulfated Detergents, Sat'd	100	215	225	200	200	210(9)
Sulfur Chloride, Fumes	---	---	---	NR	200	---
Sulfur Dioxide(2)(6)	(9)	(9)	(9)	250	200	210(5)
Sulfur Dioxide, Dry Gas(2)(6)	150	150	150	150	200	210

Chemical	RED THREAD II	GREEN THREAD	Z-CORE	RB-2530 RB-1520	CL-2030 CL-1520	F-CHEM (9)(20)
Maximum Recommended Service Temperature °F						
Sulfur Dioxide, Wet(2)(6)	---	---	---	150	200	210
Sulfur Trioxide/Air/Dry	---	---	---	NR	200	210
Sulfuric Acid, 1-2%	75	205(15)	200	200	150	210
Sulfuric Acid, 3-10%	NR	150(15)	200	200	150	210
Sulfuric Acid, 10-25%	NR	150(15)	150	150	150	210
Sulfuric Acid, 25-50%	NR	NR	175	100	150	200
Sulfuric Acid, 50-70%	NR	NR	175	NR	NR	180
Sulfuric Acid, 75%	NR	NR	120	NR	NR	100
Sulfuric Acid, 75-98%	NR	NR	120	NR	NR	NR
Sulfuric Acid, 100%	NR	NR	100	NR	NR	NR
Sulfuric Acid, Fuming, Oleum	NR	NR	100	NR	NR	(9)
Sulfurous Acid, 6%	NR	75(15)	75	---	120	100
Sulfurous Acid, 10%	NR	NR	---	---	---	100
Superphosphoric Acid	NR	NR	---	---	---	210
Tail Oil	---	150	225	150	210	150
Tannic Acid, 15%	210	225	275	200	200	210
Tannic Acid, Sat'd	---	---	---	200	200	210
Tartaric Acid, 10%	210	225	275	250	200	210
Tartaric Acid, Sat'd	210	225	275	250	200	210
Terephthalic Acid, 25%	---	---	---	100	NR	---
Tetrachloroethane 1, 1, 2, 2	NR	NR	150	---	---	NR
Tetrachloroethylene, 100%	150	150	175	---	---	80
Tetrahydrofuran - THF	NR	NR	100	---	---	NR
Tetraethyllead	---	---	---	100	NR	---
Tetrapotassium Pyrophosphate, 60%	---	---	---	NR	150	120
Tetrasodium Ethylene-Diamine, Sat'd	NR	NR	---	---	---	120
Tetrasodium Ethylenediaminetetraacetic A	(9)	(9)	(9)	150	150	150(5)
Thioglycolic Acid, 10%	NR	NR	---	NR	NR	100
Thionyl Chloride, 100%	NR	NR	(9)	(9)	(9)	(9)
Thionyl Chloride, Vents	NR	NR	120	---	---	NR
Titanium Chloride	---	---	---	175	175	---
Titanium Dioxide	---	---	---	200	175	---
Tin Chloride "see Stannous Chloride"						
Tin Plating (9)	NR	---	---	NR	200	200(5)
Tobias Acid (9)	---	---	---	NR	200	210
Toluene Sulfonic Acid	NR	NR	---	NR	80	210(9)
Toluene, 100%	200	200	200	150	NR	NR
Tomato Catsup	---	205	250	---	---	---
Tomato Puree	---	205	250	---	---	---
Transformer Oil (chloro-phenyl types)	---	---	100	---	---	---
Transformer Oil (mineral oil type)	210	225	275	225	200	210
Tributyl Phosphate	---	---	---	NR	150	120
Trichloroacetic Acid, 50%	---	---	---	---	---	210
Trichloroethane 1, 1, 1	150	150(1)	175	---	---	100
Trichloroethylene, 100%	120	120	150	150	NR	NR

Chemical	RED THREAD II	GREEN THREAD	Z-CORE	RB-2530 RB-1520	CL-2030 CL-1520	F-CHEM (9)(20)
Maximum Recommended Service Temperature °F						
Trichloromonofluoromethane, 100%	75	75	120	---	---	80(5)
Trichlorophenol, 100%	NR	NR	100	NR	NR	NR
Tricresyl Phosphate	NR	---	---	NR	150	100
Tridecylbenzene Sulfonate	---	---	---	---	---	210
Triethanolamine, 100%	150	150(1)	150	100	100	120
Triethylene Glycol	---	---	---	NR	100	180
Trimethylene Chlorobromide, 100%	---	---	150	---	---	NR
Tripropylene Glycol	---	---	---	NR	150	150
Trisodium Phosphate, All	100	200	225	150	200	210
Tung Oil	---	---	---	200	100	---
Turpentine, 100%	100	100	150	75	100	100
TWEEN Surfactant	---	---	---	NR	125	150
Urea, 50%	200	200	225	150	150	150
Urea, Sat'd	200	200	225	150	125	150
Urea Formaldehyde Resin	---	---	---	150	120	100
Vegetable Oils	200	225	275	225	210	210
Vinegar, 300 Grain,"Acetic Acid"	NR	120	120	100	100	180
Vinyl Acetate Monomer,100%	NR	NR	120	75	NR	NR
Vinyl Ester Resin, 45% Styrene	75(1)	75(1)	150	---	---	---
Vinyltoluene, 100%	80	80	200	---	---	80
Water, Brine	210	225	275	212	175	210
Water, Chlorinated, 0-100 ppm CL2	150	225	275	200	200	180
Water, Chlorinated, 100-200 ppm CL2	NR	200	275	200	200	180
Water, Chlorinated, Sat'd	NR	NR	NR	NR	150	180
Water, Deionized	200	205	275	212	175	180
Water, Distilled	200	205	275	212	175	180
Water, Fresh	210	225	275	212	175	210(13)
Water, Hard	200	225	275	212	175	180
Water, pH 2-13	210	225	275	212	175	180
Water, Reverse Osmosis	200	225	275	212	175	210(13)
Water, Salt	210	225	275	250	175	210
Water, Sea	210	225	275	250	175	180
White Liquor (Pulp Mill)	---	---	275	---	---	180(5)(13)
Xylene, 100%	150	150	200	125	NR	NR
Zinc Bromide	---	---	---	250	200	---
Zinc Chlorate, Sat'd	---	---	---	---	---	210
Zinc Chloride, 50%	210	215	250	250	200	210
Zinc Electrolyte	---	---	---	NR	150	150
Zinc Nitrate, Sat'd	200	200	250	---	200	210
Zinc Plating Sol. (Contact Smith Fibercast)	---	---	---	---	---	160
Zinc Sulfate, Sat'd	200	215	275	250	200	210

General Notes

NR = Not Recommended except for very low concentrations, contact NOV Fiber Glass Systems Applications Engineering.

--- = Data not available at time of printing, contact NOV Fiber Glass Systems Applications Engineering for recommendations.

Spills or Upset Conditions

Flush the system immediately if spills or upsets exposes the piping to chemicals that have not been recommended.

Solvent Applications

Solvents may separate from the fluid stream in piping with static or low flow rates. The solvents will be concentrated and may damage piping not recommended for 100% concentrations. Flush the piping system immediately after shutdown to prevent solvent damage. Vent lines carrying solvent vapors can also have high concentrations of liquid solvent due to condensation. The condensation can affect the service life of systems not recommended for full concentrations.

Mixing Chemicals in the Piping System

Careful consideration should be given to the by-products of mixing chemicals. By-products of chemical reactions may aggressively corrode a piping system.

Abrasive Fluid

Piping is used successfully in many abrasive slurry applications. Products made especially for abrasive applications are available. Products selection is dependent on particle size, percent solids, particle hardness, flow rates and continuous or intermittent usage.

Regulations & Standards

Local, state, or federal regulations, or industry standards may govern the use of our products in particular applications and should be reviewed by the customer to assure compliance.

Table Related Notes

1. Maximum temperature for which information is available; could be serviceable at higher temperatures. Consult NOV Fiber Glass Systems.
2. Avoid use of piping systems where contact with liquefied gases, such as chlorine or sulfur dioxide, is a possibility. Dry gases under pressure can condense to liquids in cool weather. This situation should be avoided. Liquid chlorine and liquid sulfur dioxide should not be confused with water solutions of these gases.
3. A Novolac vinyl ester resin lined product can be recommended, contact NOV Fiber Glass Systems Applications Engineering.
4. NOV Fiber Glass Systems does not recommend pneumatic conveying of dry chemicals.
5. A double synthetic veil liner is recommended.
6. Consult your local representative concerning all pressurized gas applications if the pipeline is not buried at least 3 feet deep. Under no circumstances are piping systems recommended for above ground pressurized gas lines if the operating pressures exceed 25 psig for 1-6" pipe, 14 psig for 8" pipe, 9 psig for 10" pipe, 6 psig for 12" pipe, 5 psig for 14" pipe, 4 psig for 16" pipe and 1 psig for 18" and larger sizes.
7. A bisphenol vinyl ester or epoxy resin is preferred for this application.
8. A double C-veil liner is recommended.
9. Check with NOV Fiber Glass Systems Applications Engineering for specific recommendations.
10. Benzoyl peroxide - DMA cured vinyl ester resin, double synthetic veil liner, and secondary post cure is recommended.
11. Saturated at atmospheric pressure. Higher concentrations or super saturation caused by higher pressure in the system may increase corrosion.
12. A double surfacing veil and 200-mil liner is recommended.
13. A secondary post cure is recommended.
14. Suggested up to maximum stable temperature for fluid. To avoid rapid attack, stabilize Sodium Hypochlorite to pH of 11 or greater at a maximum temperature of 120°F.
15. Grooved adapters and 8" and larger reducer bushings are not recommended for this service. Exposed surfaces and/or threads of fittings must be covered with adhesive during installation. Use adhesive as thread locking compound in these services.
16. Heavy wall products such as Z-CORE, CENTRICAST CL-2030, CENTRICAST RB-2530 or 100 mil lined F-CHEM should be used in this application for extended economic service life.
17. A double C-Veil with ECR mat 200-mil liner is recommended.
18. Perchloric acid can be dangerous when exposed to organics. Fully evaluate use.
19. For very low acid or caustic concentrations see "Water, pH 2-13" for recommended service temperatures.
20. Based on standard bisphenol A vinyl ester resin. Consult with NOV Fiber Glass Systems Applications Engineering to determine the recommended resin and liner thickness for your specific application.
21. Suggested up to maximum stable temperature for fluid.
22. Requires special adhesive.
23. Not recommended above boiling point.

18



National Oilwell Varco has produced this brochure for general information only, and it is not intended for design purposes. Although every effort has been made to maintain the accuracy and reliability of its contents, National Oilwell Varco in no way assumes responsibility for liability for any loss, damage or injury resulting from the use of information and data herein nor is any warranty expressed or implied. Always cross-reference the bulletin date with the most current version listed at the website noted in this literature.

www.fgspipe.com

2700 West 65th Street
Little Rock, Arkansas 72209
Phone: 1 (501) 468-4010

25 S. Main Street
Sand Springs, Oklahoma 74063
1 (918) 245-6651

 **Fiber Glass Systems**

©Trademark of NATIONAL OILWELL VARCO
©2010, NATIONAL OILWELL VARCO
E5615 December 2010

Appendix D: GreenThread Pipe General Specifications

This page left intentionally blank

**GREEN THREAD® 250 Piping System
GENERAL SPECIFICATIONS**

SECTION 1 – Scope

This section covers the use of fiberglass reinforced plastics (FRP) pipe for critical services up to 230°F (110°C) and 250 psig (18 bar) steady pressure. This piping system shall be furnished and installed complete with all the fittings, joining materials, supports, specials and other necessary appurtenances.

SECTION 2 – General Conditions

2.01 Coordination. Materials furnished and work performed under this section shall be coordinated with related work and equipment specified under other sections, i.e. Valves, Supports and Equipment.

2.02 Governing Standards. Except as modified or supplemented herein, all materials and construction methods shall comply with the applicable provisions of the following specifications and tested using the following standards, and shall carry U.S. Coast Guard and ABS Type-Approval Certificates for the proposed services :

Standard Specifications

- ASTM D2996 - Standard Specification for Filament-Wound "Fiberglass" (Glass-Fiber-Reinforced Thermosetting Resin) Pipe
- ASTM D4024 - Standard Specification for Reinforced Thermosetting Resin (RTR) Flanges
- IMO A.753(18) - Guidelines for the Application of Plastic Pipes on Ships Standard Test Methods
- ASTM D2992 - Standard Practice for Obtaining Hydrostatic or Pressure Design Basis for "Fiberglass" (Glass-Fiber-Reinforced Thermosetting Resin) Pipe and Fittings
- ASTM D1599 - Standard Test Method for Short-Time Hydraulic Failure Pressure of Plastic Pipe, Tubing and Fittings
- ASTM D2105 - Standard Test Method for Longitudinal Tensile Properties of "Fiberglass" (Glass-Fiber-Reinforced Thermosetting Resin) Pipe and Tube
- ASTM D2412 - Standard Test Method for Determination of External Loading Characteristics of Plastic Pipe by Parallel-Plate Loading

ASTM F1173 - Standard Specification for Thermosetting Resin Fiberglass Pipe Systems to be used for Marine Applications

2.03 Quality Assurance. Pipe manufacturer's quality program shall be in compliance with ISO 9001 and/or API Q1.

2.04 Delivery, Storage, and Handling. Pipe and fittings shall be protected from damage due to impact and point loading. Pipe shall be properly supported to avoid damage due to flexural strains. The contractor shall not allow dirt, debris, or other extraneous materials to get into pipe and fittings. All factory machined areas shall be protected from sunlight until installed.

2.05 Acceptable Manufacturers. Fiber Glass Systems or approved equal.

SECTION 3 – Materials and Construction

3.01 1"-24" (25mm-600mm) Pipe. The pipe shall be manufactured by the filament winding process using an amine cured epoxy thermosetting resin to impregnate strands of continuous glass filaments which are wound around a mandrel at a 54¼° winding angle under controlled tension. Pipe shall be heat cured and the cure shall be confirmed by determining the glass transition temperature.

All pipe shall be supplied with square-cut ends for use with mechanical couplings or with positive-stop socket joint fittings in the 1"-12" (25mm-300mm) sizes or matching tapered fittings in 14"-24" (350mm-600mm) sizes.

All pipe shall be supplied with a nominal 0.020" (0.5 mm) thick reinforced liner, made of the same resin system as the pipe. Minimum reinforced wall thickness of pipe shall be greater than 0.140" (3mm).

The pipe shall have a minimum continuous steady pressure rating of 250 psig (18 bar) at 200°F (93°C) in accordance with ASTM D2992 Procedure B.

Where required by code or specified on drawings, pipe shall be electrically conductive. Conductivity to be enabled by incorporation of conductive filaments (typically carbon or graphite) in the pipe wall, at predetermined intervals, and shall have a nominal 0.020" (0.5 mm) thick conductive liner reinforced with conductive veil, to prevent the accumulation of potentially incendive static charge buildup.

Suggested specification for
GREEN THREAD® 250 Piping System

3.02 Flanges and Fittings. All fittings shall be manufactured using the same type materials as the pipe, and shall be manufactured by filament winding methods.

Fittings shall be adhesive bonded or flanged.

Flanges shall have ANSI B16.5 Class 150 bolt hole patterns, unless otherwise specified.

All fittings shall be made electrically conductive by the incorporation of conductive filaments (woven, non-woven or continuous) in the liner and /or wall of the fittings and flanges.

3.03 Gaskets. Gaskets shall be 1/8" (3 mm) thick, 60-70 durometer full-face type suitable for the service shown on the drawings and as recommended in the manufacturer's standard installation procedures.

3.04 Adhesive. Adhesive shall be manufacturer's standard for the piping system specified.

3.05 Bolts, Nuts, and Washers. ASTM A307, Grade B, hex head bolts shall be supplied. Washers shall be supplied on all nuts and bolts.

3.06 Acceptable Products. GREEN THREAD 250 as manufactured by Fiber Glass Systems or approved equal.

3.07 ASTM D-2996 Cell Classification. Pipe shall conform to the following Cell Classifications.

1"	RTRP-11FW1-3111
1 1/2"	RTRP-11FW1-3111
2"	RTRP-11FW1-3112
3"	RTRP-11FW1-3112
4"	RTRP-11FW1-3112
6"	RTRP-11FW1-3113
8"	RTRP-11FW1-3116
10"	RTRP-11FW1-3116
12"	RTRP-11FW1-3116
14"	RTRP-11FW1-3116
16"	RTRP-11FW1-3116
18"	RTRP-11FW1-3116
20"	RTRP-11FW1-3116
24"	RTRP-11FW1-3116

SECTION 4 – Fire Resistance

4.01 Fire Endurance. Piping systems shall be designed to meet the following fire endurance requirements with no passive fire protection:

- 1) IMO A.753(18), Appendix 2, "Test Method for Fire Endurance Testing of Water Filled Plastic Piping," Level 3
- 2) ASTM F 1173, Section A5 "Wet Condition Classification of Water-Filled Plastic Pipe"

SECTION 5 – Installation and Testing

5.01 Training and Certification. All joints installed or constructed in the field shall be assembled by employees of the contractor who have been trained by the pipe manufacturer. The pipe manufacturer or their authorized representative shall train the contractor's employees in the proper joining and assembly procedures required for the project, including hands-on training by the contractor's employees. Each bonder shall fabricate one pipe-to-pipe and one pipe-to-fitting joint which shall pass the minimum pressure test for the application without leaking. Training and certification shall be conducted in accordance with ANSI B31.3.

This suggested specification is being provided only as a general reference for specifying FGS piping products. It is not intended to be all-inclusive or to address all of the specific applications or requirements for your particular project.



It is the policy of Fiber Glass Systems to improve its products continually. In accordance with that policy, the right is reserved to make changes in specifications, descriptions, and illustrative material contained in this bulletin as conditions warrant. Always cross-reference the bulletin date with the most current version listed at www.smithfibercast.com. The information contained herein is general in nature and is not intended to express any warranty of any type whatsoever, nor shall any be implied.

Appendix E: GreenThread Certifications

This page left intentionally blank

Certificate of Compliance

Certificate Number **290307-MH30132**
Report Reference **26122006, 28122006**
Issue Date **2007 March 29**

Page 1 of 1



Issued to: **Smith Fibercast**
2700 W 65th St
Little Rock, AR 72209
United States

This is to certify that representative samples of

Pipes and Related Products

Green thread fabricated fittings (D) Red thread II fabricated fittings (C)
Green thread fabricated pipes (D) Red thread II fabricated pipes (C)

Have been investigated by Underwriters Laboratories Inc.® in accordance with the Standard(s) indicated on this Certificate.

Standard(s) for Safety: ANSI/NSF Standard 61 - Drinking Water System Components - Health Effects

Additional Information: Water Contact Temperature: 23 deg. C
(C) Classified for sizes ≥ 2 in.
(D) Classified for sizes ≥ 8 in.

Only those products bearing the UL Classification Mark should be considered as being covered by UL's Classification and Follow-Up Service.

The UL Classification Mark includes: UL in a circle symbol:  with the word "CLASSIFIED" (as shown); a control number (may be alphanumeric) assigned by UL; a statement to indicate the extent of UL's evaluation of the product; and, the product category name (product identity) as indicated in the appropriate UL Directory.

Look for the UL Classification Mark on the product

Issued by:

Nancy J. Batey, Project Handler II

Underwriters Laboratories Inc.

Reviewed by:

Douglas Frederick, Senior Project Chemist

Underwriters Laboratories Inc.

Any information and documentation involving UL Mark services are provided on behalf of Underwriters Laboratories Inc. (UL) or any authorized licensee of UL. For questions in The United States of America you may call 1-877-UL-HELPS.

Certificate of Compliance

Certificate Number **300307-MH30132**
Report Reference **18122006, 21122006, 20012006**
Issue Date **2007 March 30**

Page 1 of 1



Issued to: **Smith Fibercast**
2700 W 65th St
Little Rock, AR 72209
United States

This is to certify that representative samples of

Joining and Sealing Material

DS-7014 (B) DS-8000 Series (B) +Water contact temp: 82 deg. C
DS-7024 (B) Weldfast 3033 (A)+ Water contact temp: 23 deg. C
DS-7054 (B) Weldfast 3033-C (A)+ Surface area to volume ratio 2 sq cm/L
DS-7069 (B)

Have been investigated by Underwriters Laboratories Inc.® in accordance with the Standard(s) indicated on this Certificate.

Standard(s) for Safety: ANSI/NSF Standard 61 - Drinking Water System Components - Health Effects

Additional Information: (A) For joining pipe/fittings - to be heat cured in accordance w/manufacturer's instructions.
(B) For joining pipe/fittings ≥ 1 in. in size

Only those products bearing the UL Classification Mark should be considered as being covered by UL's Classification and Follow-Up Service.

The UL Classification Mark includes: UL in a circle symbol:  with the word "CLASSIFIED" (as shown); a control number (may be alphanumeric) assigned by UL; a statement to indicate the extent of UL's evaluation of the product; and, the product category name (product identity) as indicated in the appropriate UL Directory.

Look for the UL Classification Mark on the product

Issued by:
Nancy Batey, Project Handler

Reviewed by:
Douglas Frederick, Senior Project Chemist

Certificate of Compliance

Certificate Number **290307-MH30132**
Report Reference **02012007, 18012007, 04012007**
Issue Date **2007 March 29**

Page 1 of 1



Issued to: **Smith Fibercast**
2700 W 65th St
Little Rock, AR 72209
United States

This is to certify that representative samples of

Pipes and Related Products

Green thread molded fittings (D) Red thread II spray up fittings (E)
Red thread II molded fittings (D) Red thread II wound fittings (D)
Green thread spray up fittings (E) Green thread wound fittings (D)

Have been investigated by Underwriters Laboratories Inc.® in accordance with the Standard(s) indicated on this Certificate.

Standard(s) for Safety: **ANSI/NSF STANDARD 61 - Drinking Water System Components - Health Effects**

Additional Information: **Water Contact Temperature: 23 deg. C**
(D) = Classified for sizes > = 1 in.
(E) = Classified for sizes > = 8 in.

Only those products bearing the UL Classification Mark should be considered as being covered by UL's Classification and Follow-Up Service.

The UL Classification Mark includes: UL in a circle symbol:  with the word "CLASSIFIED" (as shown); a control number (may be alphanumeric) assigned by UL; a statement to indicate the extent of UL's evaluation of the product; and, the product category name (product identity) as indicated in the appropriate UL Directory.

Look for the UL Classification Mark on the product

Issued by:

Nancy J. Batey, Project Handler II

Underwriters Laboratories Inc.

Reviewed by:

Douglas Frederick, Senior Project Chemist

Underwriters Laboratories Inc.

Any information and documentation involving UL Mark services are provided on behalf of Underwriters Laboratories Inc. (UL) or any authorized licensee of UL. For questions in The United States of America you may call 1-877-UL-HELPS.

This page left intentionally blank

Appendix F: Fiberglass Well Construction Correspondence

This page left intentionally blank



6503 Diamond Ct
 Colleyville, TX 76034
 Mobile: 817-239-6049
 Fax: 501-568-6440
 Email: rick.heidinger@nov.com

February 10, 2011

Mr. Kevin Spencer, P.G.
 R.W. Harden & Associates, Inc.
 3409 Executive Center Drive, Suite 226
 Austin, TX 78731

Re: GRE Casing

Dear Mr. Spencer,

In reference to your request on 24" Glass Reinforced Epoxy (GRE) casing we are pleased to offer our Green Thread® Casing for your project.

The Green Thread product line carries a NSF Standard 61 listing including all fitting, casing/piping and adhesives. The Underwriters Laboratory certification papers are attached for your reference.

As we understand your application the conditions are as listed below:

Well depth – 242'
 Cement weight – 13.5 lbs./gallon
 Cure Temperature of Cement - 120°F

Under these installation conditions Fiber Glass Systems (FGS) recommends the use of 24" Green Thread Casing as follows:

Size	ID Min. (in.)	OD Min. (in.)	OD Max. (in.)	Liner Min. (in.)	Reinforced Wall Min. (in.)	Max. Internal Pressure (psig)	Vacuum/External Pressure @ Ambient Temperature	
							Ultimate Collapse Pressure	Cementing Rating Pressure
24"	23.840	25.354	25.442	0.010	0.737	250	237	79

The maximum internal pressure rating has 4 to 1 safety factor and the collapse rating has a 3 to 1 safety factor per ISO 14692 for continuous service.

What we are concerned with for the collapse would be the column head pressure DIFFERENTIAL across the pipe wall at the worse place, the bottom joint. To calculate this we use the following formula:

Column head pressure = feet of head / 2.3106 Hf/psi * Specific Gravity

Annulus Head Pressure

13.5 lb/gal Density = 1.618 Sp Gr
 $242 \text{ ft} / 2.3106 \text{ Hf/psi} * 1.618 = 169.46 \text{ psig}$

Internal Casing Pressure

Assume fresh water at Sp Gr = 1.00
 $242 \text{ ft} / 2.3106 \text{ Hf/psi} * 1.000 = 104.73 \text{ psig}$

Pipe Wall Pressure Differential

$169.46 \text{ psig} - 104.73 \text{ psig} = 64.73 \text{ psig}$
This gives a pipe pressure of -64.73 psig (the negative sign shows that the pressure is external to the casing)

Therefore, if your casing collapse pressure RATING is >64.73 psi, then it should not collapse when the cement is put in place.

This would be the influences due to just the column head pressures, in other words, worse case.

However, probably in reality, the drilling contractor will shut a valve or something on the wellhead so as not to allow the cement to U-tube back around into the casing. When this is done, this puts additional pressure onto the inside of the casing and puts the pressure differential at the bottom of the well to 0. A pressure profile for this case and for this well from Star Well is attached.

FGS has committed to providing full site installation service on this project. Our personnel as well as equipment and spare parts will be available 24/7 during the installation of the GRE casing.

Should you need any additional information please let me know.

Sincerely,



Richard Heidinger
Director
Sales & Marketing– North America

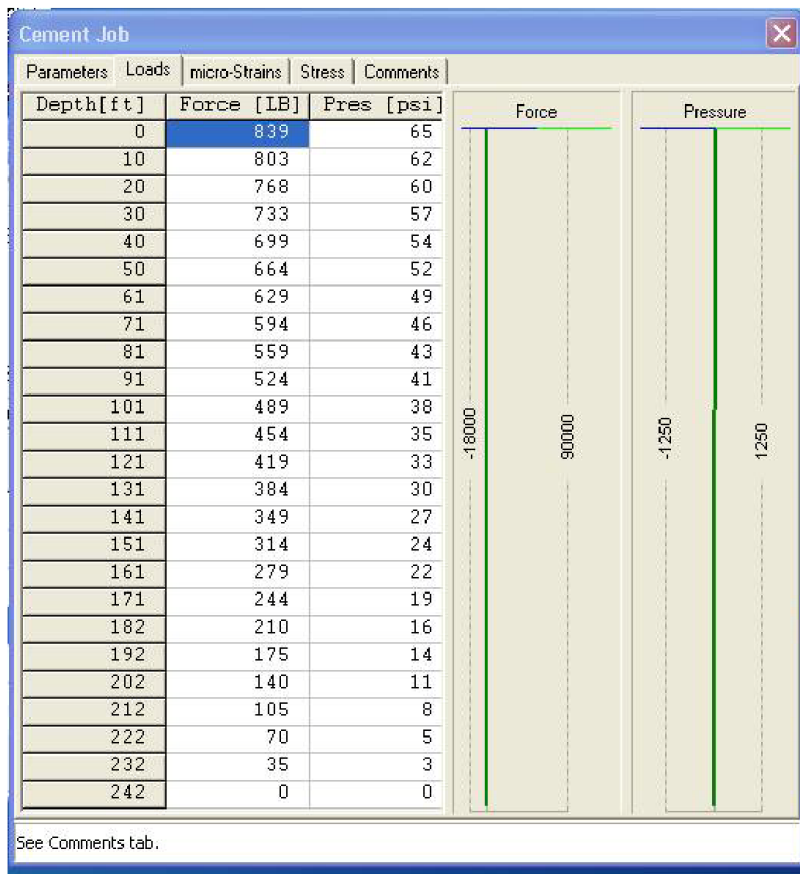

This page left intentionally blank

Appendix G: GreenThread Pipe Coupling System Schematics

This page left intentionally blank

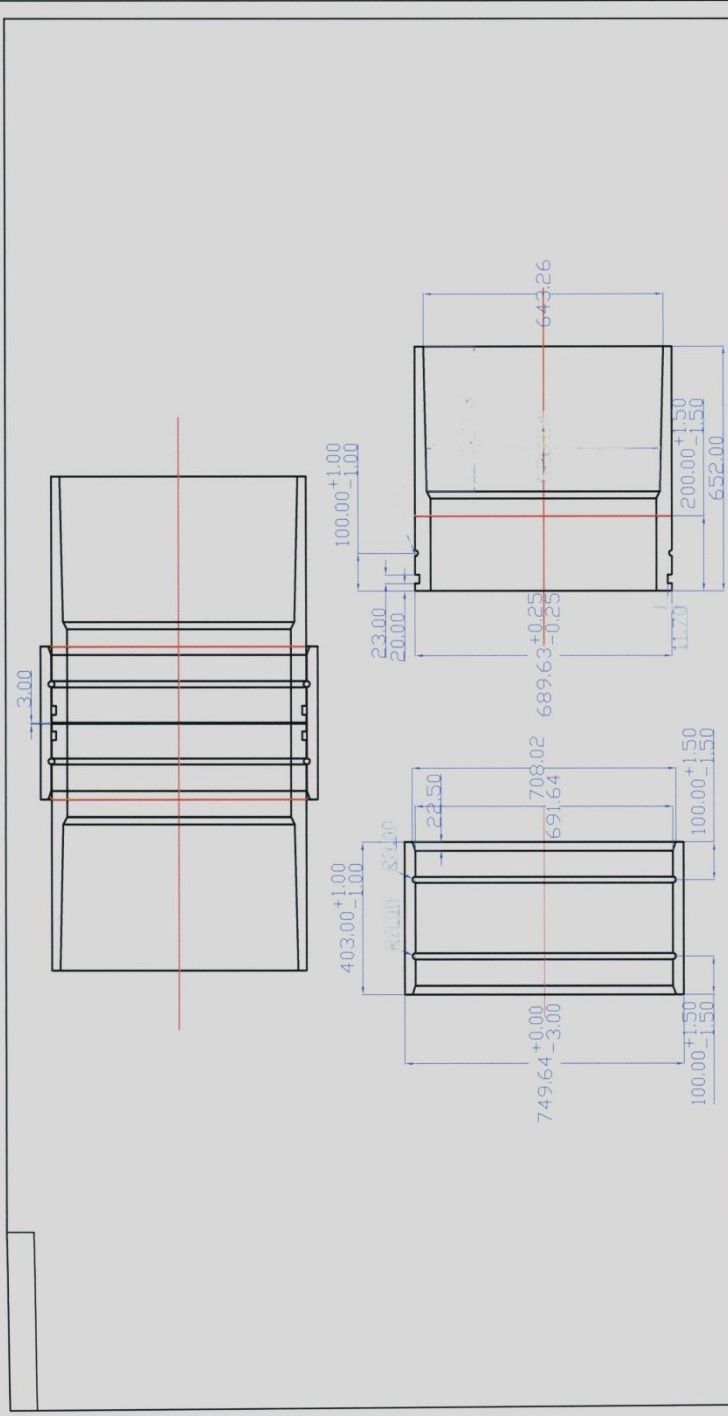

Pipe Size	Oring		Key			
	Diameter(mm)	Min. Diameter(mm)	Max. Diameter(mm)	ID(mm)	Diameter(mm)	Length(+/-5mm)
24"	18	17.5	18.5	611	15	2300

NO.	Technical Requirements	Reference Standard
1.	Tg value: Min.130C	API 15LR Appendix B
2.	Fiberglass Content: Min.60%	API 15LR Appendix A
3.	Mil Pressure Test: 2.0MPa	ASTM-1599
4.	ST Burst Test: 6.9MPa	ASTM-1599
5.	Unit Thickness: 0mm	ASTM-1567
6.	Electrical Resistance Per unit length:1X100,000 ohm/m	ASTM F1173 Appendix X3
7.	Appearance	ASTM-2563 Level 1

REV.	DESCRIPTION	BY	DATE	PRODUCTION DRAWING
01	Key	ker60a		Water Well Casing 07250 24"
02	Key	ker60a		

MATERIAL	QTY	CONTR. DIMENSIONS	SCALE
GRE			1:1

DRAWING NO.	SHEET	NO. OF SHEETS
	1 of 1	0

UNLESS OTHERWISE SPECIFIED DIMENSIONS ARE IN MM. TOLERANCE IS: ANGLES: 10.2°

This page left intentionally blank

Appendix H: TCEQ Variance Request Correspondence

This page left intentionally blank



3409 Executive Center Drive
Suite 226
Austin, Texas 78731

512/345-2379
FAX 512/338-9372

R. W. Harden & Associates, Inc.
Hydrologists – Geologists - Engineers

April 21, 2011

Mrs. Vera Poe., P.E.
TCEQ- Water Supply Division,
Util. Creation and Plan Rev. Team MC 153
12100 Park 35 Circle, Bldg. F
Austin, TX 78753

Re: North Alamo Water Supply Corporation Public Water Supply Wells – Plant #5 – Donna
Production Wells 1 and 2, Hidalgo County, Texas Plan Review Log Number P-11122010-049

PWS No. 1080026

Dear Mrs. Poe:

North Alamo Water Supply Corporation (NAWSC) wishes to request a variance for material setting of Donna Production Well 2, conditionally approved for construction (Plan Review Log Number P-11122010-049) using stainless steel. NAWSC requests a variance to use fiberglass production casing rather than stainless steel, as originally requested.

To accommodate the change from stainless steel to fiberglass production casing, the reamed hole diameter is increased to 33 inches. The fiberglass casing is secured together with the use of couplings and the outside diameter of the coupling is 29.5 inches. A minimum 33-inch reamed hole is now specified. All other aspects of the approved plan are identical.

Please find the enclosed “Technical Specifications for Donna Plant Production Well,” “Public Water System Plan Review Submittal Form,” “Checklist for Proposed Public Water Supply Well/Spring,” “GreenThread Fiberglass Casing Specifications”, “GreenThread Fiberglass Casing Engineering Data”, “GreenThread Fiberglass Casing Certification for Public Drinking Water Safety”, “Fiber Glass Systems Recommended Usage Correspondence”, and “Public Water Well Construction Regulations” for the states of Florida and Nebraska. Public water wells using fiberglass casing have been constructed in compliance with state regulations in the states of Florida and Nebraska; both states allow construction of non-metallic production casing in public water well systems. Rules 12-003.04c, 12-004.02c-e, 12.011.02a in the Nebraska code and rules 62-532.500.1a, 62-532.500.1f, 62-532.500.1g in the Florida code give guidance for use of the fiberglass casing. The non-metallic materials proposed for the Donna wells conform to standard for safety of ANSI/NSF Standard 61 – Drinking Water System Components and strength and dimensions tolerances stated in the Florida and Nebraska regulations. In accordance with these regulatory standards, NAWSC requests an exception to use GreenThread fiberglass casing, as documented in the Technical Specifications, in Donna Production Well 2.

The proposed well will be part of the North Alamo Water Supply Corporation’s existing water supply system. Based on preliminary water quality studies, the groundwater below the subject

property is considered brackish. Most of the well water will be treated using reverse osmosis to reduce dissolved constituents and a portion of the untreated water will be blended with the desalinated water to achieve a water quality that is within State Primary and Secondary Drinking Water Standards. Plans and Specification for the treatment plant will be forthcoming from NRS Consulting Engineers (NRS) of Harlingen, TX.

In reference to the enclosed "Checklist for Proposed Public Water Supply Well/Spring" and attached map, we have the following comments:

1. On item number 2, a sealed engineer's report that sizes the well based on the connections to be served has not been included because these wells and associated treatment facility will connect into the existing distribution system of North Alamo Water Supply Corporation (NAWSC) to supplement existing supplies. If further information is needed, please let us know and we will forward any requests for additional information to NAWSC.
2. On item number 4, a draft of the sanitary control easements has not been included because the proposed wells will be more than 150 feet from the property line, which is owned by NAWSC. The deed for the property is included in this packet.
3. On item number 10, the entire site is currently surrounded by an intruder resistant fence.
4. On item number 11, the site currently has all weather access.

If you have any questions on this submittal please do not to hesitate to call us.

Sincerely,



Robert Harden, P.E.
Vice-president
R. W. Harden & Associates, Inc.



The seal appearing on this document was authorized by Robert Harden, P.E. 79290 on April 21, 2011. Firm Registration Number: F-1524

Bryan W. Shaw, Ph.D., *Chairman*
Buddy Garcia, *Commissioner*
Carlos Rubinstein, *Commissioner*
Mark R. Vickery, P.G., *Executive Director*



PWS/1080029/CO
RN 101247922
CN 600633713

TEXAS COMMISSION ON ENVIRONMENTAL QUALITY

Protecting Texas by Reducing and Preventing Pollution

July 29, 2011

Mr. Kevin Spencer, P.G.
R.W. Harden & Associates, Inc.
3409 Executive Center Drive, Suite 226
Austin, TX 78731

Subject: Request for an Exception to the Well Casing Material Rule
North Alamo Water Supply Corporation - PWS I.D. 1080029
Proposed Donna Production Well
Hidalgo County, Texas

Dear Mr. Spencer:

On April 21, 2011, the Texas Commission on Environmental Quality (TCEQ) received your letter dated April 21, 2011, requesting an exception to the requirement that the casing material for a public water system well conform to American Water Works Association (AWWA) standards as specified in Title 30 of the Texas Administrative Code (TAC) §290.41(c)(3)(B). Specifically, this rule requires the casing material to be new carbon steel (American Society for Testing and Materials (ASTM) A139 Grade B), high-strength low-alloy steel (ASTM A606 Type 4), stainless steel (ASTM A778), or plastic (ASTM F480). The request for an exception to the casing material requirement is for the Proposed Donna Production Well 2. You are requesting to use NOV Fiber Glass Systems™ Green Thread® 250 fiberglass pipe as a well casing material. This casing material conforms to American National Standards Institute/National Sanitation Foundation (ANSI/NSF) Standard 61 and has been certified by an organization accredited by ANSI. Based on our evaluation of the information provided, we are **granting** your request. **This exception is contingent on:**

1. This approval is site-specific for the Proposed Donna Production Well 2.
2. The use of only the NOV Fiber Glass Systems™ Green Thread® 250 Piping System as indicated in your submittal.
3. The proposed 24-inch glass-fiber-reinforced thermosetting-resin pipe must be manufactured and tested in accordance with the following applicable standards:

ASTM D2996 – Standard Specification for Filament Wound Fiberglass Pipe
ASTM D4024 – Standard Specification for Reinforced Thermosetting Resin Flanges
ASTM D2992 – Standard Practice for Obtaining Hydrostatic or Pressure Design Basis for Fiberglass Pipe and Fittings
ASTM D1599 – Standard Test Method for Short-Time Hydraulic Failure Pressure of Plastic Pipe, Tube, and Fittings
ASTM D2105 – Standard Test Method for Longitudinal Tensile Properties of Fiberglass Pipe and Tube
ASTM D2412 – Standard Test Determination of External Loading Characteristics of Plastic Pipe by Parallel-Plate Loading

P.O. Box 13087 • Austin, Texas 78711-3087 • 512-239-1000 • www.tceq.texas.gov

How is our customer service? www.tceq.texas.gov/goto/customersurvey

Printed on recycled paper using soy-based ink.

Mr. Kevin Spencer, P.G.
Page 2 of 3
July 29, 2011

4. The proposed 24-inch glass-fiber-reinforced thermosetting-resin pipe has the following specifications:
 - a. Reinforced Wall Thickness – 0.737 inches (in.);
 - b. Maximum Internal Pressure – 250 psi (steady pressure);
 - c. Ultimate Collapse Pressure – 239 psi; and
 - d. Cementing Rating Pressure – 79 psi.
5. The external pressure differential during the cementing process cannot exceed 79 psi.
6. Within 90 days of well completion, to assure integrity of the casing, please provide a downhole video with narrative to the TCEQ Technical Review & Oversight Team.

Green Thread® 250 Fiberglass Well Casing

Your submittal indicates that during pressure cementing water will be used to pressurize the casing to an internal pressure of 104.73 pounds per square inch (psi) while the cement will exert an external pressure on the casing of 169.46 psi. This will create an external pressure differential of 64.73 psi, which is less than the cementing rating pressure of 79 psi. The cementing rating pressure of 79 psi is based on a 3 to 1 factor of safety over the 24-inch glass-fiber-reinforced thermosetting-resin pipe's ultimate collapse strength of 239 psi.

The AWWA does not have specifications for the use of fiberglass as well casing material. The well casing strength calculation formulas found in AWWA Standard A100-06 Appendix K, which are typically used to obtain acceptable strength values, assume that the material in question is homogeneous rather than a composite material, such as fiberglass. The strength values of the Green Thread® 250 material were obtained experimentally by the manufacturer (NOV Fiber Glass Systems™) in accordance with ASTM standard testing methods and are, therefore, only applicable to this specific material.

We note that it is expected once pressure cementing has been completed (using an approved AWWA method as specified in 30 TAC §290.41(c)(3)(C)) and the cement has cured, pressure stresses on the casing material will be negligible. Therefore, the primary concern regarding the allowable collapse pressure is failure during the construction and pressure cementation process.

If a casing failure which is not correctable occurs during the cementing process, construction of the well shall be immediately discontinued, the driller shall properly plug the drill hole, and the contractor shall notify the TCEQ. If a casing failure which is correctable occurs during the cementing process, construction of the well may continue as long as the well is returned to full compliance with all technical specifications as indicated in your submittal and all TCEQ regulations for public supply wells.

According to the information contained in your submittal the Green Thread® 250 Piping System is acceptable for use at temperatures up to 250°F (110°C). This temperature exceeds the expected cement curing temperature of 130°F. The proposed Green Thread® products received ANSI/NSF Standard 61 (NSF 61) classification (Certificate No. 290307-MH30132) from Underwriters Laboratories Inc. issued on March 29, 2007. Based on the NSF 61 classification, the proposed material is resistant to chemical leaching and will not pose a threat to public health.

Mr. Kevin Spencer, P.G.
Page 3 of 3
July 29, 2011

Please note that this exception is not intended to wave compliance with any other TCEQ requirement in 30 TAC Chapter 290. This exception cannot be used as a defense in any enforcement action resulting from noncompliance with any other requirement of 30 TAC Chapter 290.

If you have questions concerning this letter or if we can be of additional assistance, please contact David A. Williams by email at David.A.Williams@tceq.texas.gov, by telephone at (512) 239-0945, or by correspondence at the following address:

Technical Review and Oversight Team (MC-159)
Texas Commission on Environmental Quality
P.O. Box 13087
Austin, Texas 78711-3087

Sincerely,



Ada Lichaa, P.G., Manager
Plan and Groundwater Review Section
Water Supply Division
Texas Commission on Environmental Quality

AL/DAW/CRM

cc: TCEQ Harlingen Regional Office - R15
Ms. Vera Poe, P.E., TCEQ Utilities Technical Review Team (MC 159)
Mr. Dennis M. Goldsberry, President, North Alamo Water Supply Corporation,
420 South Doolittle Road, Edinburg, Texas 78542-9707

This page left intentionally blank

Appendix I: Test Drilling Report

This page left intentionally blank



3409 Executive Center Drive
Suite 226
Austin, Texas 78731

512/345-2379
FAX 512/338-9372

R. W. Harden & Associates, Inc.
Hydrologists – Geologists - Engineers

August 9, 2010

Mr. Steven Sanchez
North Alamo Water Supply Corporation
420 S. Doolittle Road
Edinburg, Texas 78539

Re: Evaluation of Donna Test Drilling Program

Dear Mr. Sanchez:

R.W. Harden and Associates, Inc. (RWH&A) has completed a test drilling program at North Alamo Water Supply Corporation's (NAWSC) Donna Plant. The results of this test drilling program in conjunction with: a) data from a previous test drilling program conducted by J&S Water Wells in 2001 b) aquifer testing of the J&S wells by RWH&A in 2008, and c) groundwater modeling performed by RWH&A in 2009 form the basis for the recommendation provided herein. Under our current contract RWH&A has conducted the following work:

- Planned the test drilling program based on input from NAWSC and NRS-Befesa (NRS),
- Prepared a very general specification for conducting the work,
- Obtained bids from qualified drilling contractors,
- Coordinated the test drilling program with the contractor and NAWSC,
- Observed critical aspects of the test drilling program including sand sampling, geologic logging, geophysical logging, test well installation, aquifer testing, water quality sampling, and test hole plugging,
- Analyzed the data collected in this phase of testing as well as data collected during previous testing efforts,
- Conducted additional analytical groundwater modeling to estimate potential well yields, and
- Provided recommendations for well construction and estimates of well yield (contained herein).

Based on previous work efforts and discussions with NAWSC staff, it was concluded that the shallow gravel zones of the Gulf Coast aquifer provided the best opportunity to obtain the desired raw water supply. Aquifer testing conducted in 2008 indicated that the aquifer transmissivity in the shallow gravel zone at Test Well 2 was approximately 100,000 gallons per day per foot (gpd/ft). This is an exceptionally high transmissivity for this aquifer, and while it may reduce the amount of drawdown in a production well completed at that location, it is unlikely that the regional transmissivity is that high. But because of space considerations, it was not feasible to put the production well at the Test Well 2 location; therefore a test hole was drilled at a location closer to where a production well could be located. This test hole (Test Hole 3) was drilled, geologically and geophysically, logged and sand samples were collected. NAWSC opted to not have a test well completed at that location. Based on the information obtained from that test hole

Mr. Steven Sanchez
August 9, 2010
Page 2

and RWH&A's experience in evaluating test hole data, it is unlikely that the aquifer transmissivity at Test Hole 3 is 100,000 gpd/ft. Without actual aquifer test data, it is difficult to predict what an individual well will yield, but based on the available data, RWH&A estimates that a yield of about 1,000 gallons per minute may be possible for about five years. This estimate takes into account interference drawdown from: 1) a second well completed at the Donna plant, 2) Owassa Road Plant Well #1, 3) Doolittle Road plant Well #1 (shallow well), 4) Southmost Regional Water Authority, and 5) planned pumpage from the City of McAllen. The actual well yield will be determined after the well is installed.

A second test hole was drilled and a test well constructed during this phase of work (Test Hole 4). Aquifer testing shows that the transmissivity at that location is about 35,000 gpd/ft. Taking interference drawdown into account from the sources listed above, RWH&A estimates that a well completed at this location could also yield about 1,000 gpm for about 5 years. Actual production rates may vary a small amount based on the actual character of the gravel at the well location.

Depending on the regional characteristics of the aquifer, it is possible that the recommended pumping rates may vary and the amount of time that the recommended rate is available may vary as well. This is an issue that will be evaluated after the well is in operation, and pumping rate/water level data are evaluated. In this hydrogeologic setting, groundwater development projects are typically planned in a way that about 50 percent of the available drawdown is kept as a reserve to allow continuous operation if unfavorable regional aquifer conditions are encountered or additional new regional pumpage is added. Due to limitations of the property size and NAWSC's desire to minimize the number of wells, this project is being developed with a very small safety factor. Therefore, NAWSC should be aware that it is possible that additional off-site wells may be needed to maintain production. It is also possible that no additional well will be needed and the production amounts could be increased. This is an evaluation that will be made after the production well are installed, tested and the drawdown characteristics observed through time.

If you have any questions, please call me.



The seal appearing on this document was authorized by Kevin J. Spencer, P.G. 158 on August 9, 2010

Cc: Jesús Leal, P.E.

Sincerely,

A handwritten signature in black ink that reads "Kevin J. Spencer".

Kevin J. Spencer, P.G.
President
R. W. Harden & Associates, Inc.

Addendum: TWDB Comments and Authors' Responses

This page left intentionally blank

Reviewers' Comments on the Draft Report "Demonstration of Fiberglass Well Casings in Brackish Groundwater Wells" TWDB Contract #110483111108

The TWDB reviewers have completed their reviews of the draft report for the project. Please address the following comments in the report.

Page i. Why is this document not signed by Jesus Leal?

Jesus Leal's name has been added to the signature page.

Page 7, Table 2 shows the volumes of brackish water adapted from LBG-Guyton Associates 2003; the numbers appear not to match the totals in Table 5 from the LBG-Guyton Associates 2003 report. Please address.

These figures were adapted to represent total brackish groundwater in storage by range of water quality (1,000-3,000 and 3,000-10,000 mg/L) and total (1,000-10,000 mg/L). The "Total 1,000-10,000 mg/L" column in this report equals the sum of the "Estimated Volume In Place" and "Estimated Confined Availability" columns in the LBG-Guyton Associates, 2003 report rounded to the nearest 1,000 acre-feet. The 1,000-3,000 and 3,000-10,000 mg/L columns in this report were derived from the areal extent, thickness, storage, and specific yield numbers provided in the LBG-Guyton Associates, 2003 report. Given the level of calculations used to generate Table 2, the note on the bottom of Table 2 has been changed to read "Derived from LBG-Guyton Associates, 2003" rather than "Adapted from LBG-Guyton Associates, 2003."

Page 12, second paragraph, reference to Texas Administrative Code 290.41(c)(3)(B) should read "new carbon steel, high-strength low-alloy steel, stainless steel or plastic" to completely reference the rule.

The word "new" has been added to the quotation. Now page 11.

Page 16, list relevant ATSM standards and test titles in a table out so a non-engineer (water well driller for example) has a better understanding this portion of the report.

A table of relevant ATSM standards and tests has been included. Table 4, page 16.

Page 19. Resistance to Hydraulic Collapse Pressure section. A more detail description of annular cementing for Figure 6 should be included in the second paragraph, similar to the discussion for Figures 5 and 7. The description should include the AWWA reference.

We agree. A more detailed description of the cementing process for Figure 6 and the appropriate AWWA method is included.

Page 23. Equation 4. The list of equation terms includes reference to V (volume of submerged casing). This term is not in equation 4.

The equation was originally written to include V, but it was later decided that we should show how to calculate V, as represented by the term $((D_o/2)^2 * \pi) - ((D_i/2)^2 * \pi) * L_s$. The reference to V will be deleted. Now Page 22.

Page 23; Page 24, Table 6, and page 25, the reference to Driscoll, 1986 here and other places, should be updated to Groundwater and Wells (2007) which will become a reference for State of Texas water well driller examinations. The corrosion information is different in the new reference.

The references have been updated. Now Pages 22-24 and Table 7.

Page 24, the report uses a value of 500 mg/l as the chloride corrosive value but the latest edition of Groundwater and Wells uses a value of 200. The value should be changed to 200, with the appropriate reference (Groundwater and Wells Third Edition).

This value and the corresponding reference will be updated. Now page 23.

Page 33. The "Lesson Learned" box could be improved by suggesting an initial face-to-face meeting with relevant staff of the Texas Commission on Environmental Quality.

We agree. The Lessons learned box will now read "Early communication, including a face-to-face meeting with TCEQ staff, is critical during the planning phase. Alternative construction methods were required to properly address construction risks using fiberglass casing rather than stainless steel." Now page 32.

Page 33. Cost Evaluation section. The paragraph suggests carbon steel cost is listed in Table 8, but this cost is not present. The paragraph suggests three contractor bids are listed in Table 8, but only two contractor bids are present. Please address.

The reference to Carbon Steel has been removed because no costs for a carbon steel casing option was obtained. The reference to three contractor bids is incorrect. Only two contractors bid on this work. This correction has been made. Now pages 32-33, Table 9.

Page 33. Cost Evaluation section. Please include the length of casing in this discussion.

The length of casing is now included in the text. Now page 32.

Page 35, please define “egging.”

“Egging” refers to a pipe end that is out of round, typically resulting from mishandling. The text has been modified to define “egging”. Now Page 34.

Page 38, References section. The LBG-Guyton (2003) report is available on the TWDB website. This weblink can be inserted into this reference:

<http://www.twdb.texas.gov/innovativewater/desal/projects.asp>

The web address is included. Now Page 37.

Appendices. Please obtain and document permission to reproduce the GreenThread Pipe copyrighted information in the following appendices: Appendix A: GreenThread Pipe Product Data , Appendix C: GreenThread Pipe Chemical Resistance , and Appendix D: GreenThread Pipe General Specifications.

Permission from the manufacturer’s representative via e-mail is included at the end of this addendum.

Additional comments

If the downward compressive force on a laterally unsupported casing assembly exceeds the yield strength of the material, then the casing will buckle (Groundwater and Wells, Third Edition). A discussion of this topic with supporting comparisons of each casing material would benefit the guidance manual if this is a significant well design element one must consider.

In the discussion of tensile strength on Page 21, the casing is described as “suspended in the borehole.” The discussion of tensile strength requirements of casing precludes the need to discuss buckling because only one of these forces can be a factor, i.e. either the casing is sitting on the bottom of the hole (not recommended), or it is suspended; it can’t be both. However, an additional statement on Page 35 is provided that recommends that the casing should be suspended in the borehole. Proper installation practices require that the casing is suspended (hung) in the borehole so that there is a tensile load for AWWA interior cementing methods C.4 and C.6. For AWWA cementing method C.3, exterior method used in straight wall designs (with the screen attached to the casing), the entire casing string is typically suspended in the well prior to gravelling operations and maintained through gravelling and cementing until the cement has cured for 24 hours. Therefore, at no point during well construction should the bottom of the screen or casing be resting on the bottom of the hole. In addition to the buckling issue discussed in Groundwater and Wells, it also helps if the casing hangs as vertically as possible in the borehole to help provide a better annular seal and make pump installation easier. Pages 21 and 35.

The Texas Commission on Environmental Quality required a down-hole video with narrative as a condition of the exception approval. Please provide copy of the video> Describe whether the video documented any problems.

A copy of the down hole video will be provided in each of the 6 hard copies. The narrative is included in both hard copy and digital copy. See attachments.

A brief discussion of how the well was drilled (direct rotary circulation; reverse circulation) would be beneficial. Since a telescoping well was designed, are there any special considerations with fiberglass casing when retrieving large diameter cuttings (large gravel; cobbles)?

A statement of the drilling method (reverse circulation) is provided on Page 36. In reverse circulation the cuttings (sand/ gravel/cobbles) travel up the inside of the drill pipe, so damage to the casing would be impossible. If normal circulation methods are used, we suppose that erosion of the casing may be possible, but this possibility was not investigated. We will note that abrasion or erosion of the casing should be considered when drilling with normal circulation.

If there are any special circumstances attaching well screen to fiberglass casing (straight wall vs telescoping well), the report would benefit from a discussion on this topic. Since the casing couplings and well head flange were custom designed by the manufacturer, would custom-designed and manufactured casing to screen connection appliances be required?

This was not investigated for this project. However, the answer is yes, there would need to be a custom designed way to attach steel screen to fiberglass casing. An adaptor with grooves cut to match the coupling would probably be the most cost effective method for doing this (again, not investigated). Another option is to bond the first piece of screen to the last piece of casing at the fiberglass casing factory. We know this can be done, because we discussed making the last 10 feet of casing stainless steel to eliminate our concern over damaging the fiberglass casing when drilling out the cement plug. Ultimately, after discussion with several drillers, it was determined that: 1) the cement grout is soft enough and will drill easily enough that the drill bit would not be in contact with the casing for very many rotations, and 2) we felt like we could minimize the amount of grout in the bottom casing, so that even if drilling the bottom few feet of grout damaged the casing, it would not affect the performance of the well (the "so what?" option). The bottom 40-50 feet of casing is overlapped by a 16" stainless steel liner, with gravel pack in the casing-liner annulus. Another option is to use mill-slotted fiberglass screen. We do not prefer mill-slotted screen in high capacity gravel-packed wells because they generally decrease well-efficiency. Large mill slots or perforations in hard-rock aquifers are acceptable if the engineer is concerned about sloughing of the borehole wall (to prevent well infilling and/or large formation material from entering the casing. Discussion provided on Page 31.

Copyright Permission from NOV Fiberglass Systems

Kevin,

Sorry for the delay.

Permission granted.

Joie L. Folkers – Director of Marketing & Brand
NOV Fiber Glass Systems
17115 San Pedro Ave., Suite 200
San Antonio, TX 78232
210-477-7503 Office Phone
210-477-7560 Office Fax
281-536-6479 Mobile Phone
Joie.Folkers@nov.com

Confidentiality Statement

This electronic message transmission contains information from NOV Fiber Glass Systems and is confidential or privileged. The information is intended to be for the use of the individual or entity named above. If you are not the intended recipient, be aware that any disclosure, copying, distribution or use of the contents of this information is prohibited. If you have received this electronic transmission in error, please notify us by telephone at the office phone number above, immediately.

From: Kevin Spencer [<mailto:Kevin.Spencer@rwharden.com>]
Sent: Monday, April 15, 2013 12:53 PM
To: Francis, Brad S
Cc: Heidinger, Rick C; Folkers, Joie L
Subject: RE: Copyright permission

A friendly reminder, I still would like to have this copyright permission to include your product information in the report.

Thanks,
Kevin

From: Francis, Brad S [<mailto:Brad.Francis@nov.com>]
Sent: Monday, March 18, 2013 12:00 AM
To: Kevin Spencer
Cc: Heidinger, Rick C; Folkers, Joie L
Subject: RE: Copyright permission

Kevin:

I will pass this along to Joie Folker – Director of Marketing and Brand - who should be able to provide you with permission from the NOV FGS team.

Joe – Kevin needs this by April 1st.

Best regards,

Brad

From: Kevin Spencer [<mailto:Kevin.Spencer@rwharden.com>]
Sent: Friday, March 15, 2013 12:27 PM
To: Heidinger, Rick C; Francis, Brad S
Cc: Bob Flynn
Subject: Copyright permission

Brad or Rick,
For the Texas Water Development Board Guidance manual we are preparing for the use of fiberglass casing in public supply wells in Texas, we need to obtain permission from NOV to reprint some copyrighted information on your website. These documents are included in our appendices. Specifically we are requesting to reprint:

Product Data:
http://www.nov.com/uploadedFiles/Business_Groups/Fiberglass_Systems/C3811%20GT%20250-250C%20Product%20Data%20Sheet.pdf

Chemical Resistance Guide (in its entirety) which we accessed via:
<http://www.nov.com/folderDocs.aspx?id=13627>

Green Thread 250 Piping System – General Specifications, bulletin no. C3802 (in its entirety) accessed via: <http://www.frpsolutions.com/Product%20PDF/GT250F.pdf>

We need to secure this permission by April 1, 2013.

Please call me if you need additional information. Thank you for your assistance.

Thanks,
Kevin

Kevin J. Spencer, P.G. | President



R. W. Harden & Associates, Inc.
3409 Executive Center Drive, Suite 226
Austin, Texas 78731 | (512) 345-2379
www.rwharden.com

Attachments

This page left intentionally blank

Donna Well #2 – Fiberglass Casing Video Survey Narrative

Video date: 05/23/2012

Video conducted by *Geo Cam Inc.*

Narrative prepared by *R.W.Harden and Associates*

20 Feet – Water level reached, floating substance is residual food grade oil used in line-shaft pumping equipment used for well development and 36-hour aquifer testing.

32.3 feet – Side view of fiberglass casing. Light surface marring is present on casing wall throughout the length of the casing, likely from development equipment installation and removal. No apparent gouging or damage to the casing.

40 feet – First coupling: appears to be normal.

66 feet – Side view of casing wall. Some light scuffs present, likely from development equipment installation and removal.

82.5 feet – Second coupling: Some very minor chipping (few millimeters in width) where coupling sleeve meets casing, possibly formed during cutting and installation of coupling or installation/removal of development equipment. Total wall thickness of casing, coupling adapter, and coupling at this location is about 2 inches.

125 feet – Third coupling: Some very minor chipping (few millimeters in width) where coupling sleeve meets casing, possibly formed during cutting and installation of coupling or installation/removal of development equipment. Total wall thickness of casing, coupling adapter, and coupling at this location is about 2 inches.

148 feet – Side view of casing wall. No noticeable scratches or defects other than discoloration.

167 feet – Fourth coupling: Some very minor chipping (few millimeters in width) where coupling sleeve meets casing possibly formed during cutting and installation of coupling or installation/removal of development equipment. Total wall thickness of casing, coupling adapter, and coupling at this location is about 2 inches.

187.5 feet – Top of blank stainless steel liner, deepest documentation of fiberglass casing.

Floating particles in the well may be: iron bacteria from residual oxygenation due to well pumping and development, deposits flaking off the camera/camera cable, or mineral oil pulled downhole with the camera.

This page left intentionally blank